

This Owner's Manual is provided and hosted by [Appliance Factory Parts](#).



VIKING TVDR6616G Owner's Manual

**[Shop genuine replacement parts for VIKING
TVDR6616G](#)**



[Find Your VIKING Gas Range Parts - Select From 76 Models](#)

----- Manual continues below -----

Use & Care MANUAL



Tuscany Freestanding Dual Fuel Ranges

*TVDR3614B, CTVDR3614B
TVDR4816B, TVDR4814G, TVDR4814I,
CTVDR4816B, CTVDR4814G, CTVDR4814I
TVDR6618B, TVDR6616G, TVDR6616I
CTVDR6618B, CTVDR6616G, CTVDR6616I*

Congratulations

We hope you will enjoy and appreciate the care and attention we have put into every detail of your new, state-of-the-art range.

Your appliance is designed to offer years of reliable service. This use and care manual will provide you with the information you need to become familiar with your range's care and operation.

Your complete satisfaction is our ultimate goal. If you have any questions or comments about this product, please contact our Consumer Support Center at 1-888-845-4641.

We appreciate your choice and hope that you will again select our products for your other major appliance needs.

For more information about the complete and growing selection of products, visit us online at www.vikingrange.com

Table of Contents

Getting Started

Warnings.....	3
Before Using Range	6
Oven Functions	6

Product Controls

Range Features	7
----------------------	---

Operation

Surface Operation	8
Gas Surface Burners	8
Induction	9
Griddle/Simmer Plate Operation.....	10
Griddle/Simmer Plate Clean Up & Care.....	10
Using the Oven.....	11
Rack Positions.....	11
Bake	11
Convection Bake.....	13
TruConvection.....	16
Proof	16
Convection Defrost	16
Broil	17
Convection Broil	17

Cleaning and Maintenance

Surface Burners	18
Grates.....	18
Burner Heads / Burner Bases.....	18
Stainless Steel Parts	20
Induction Glass Top	20
Replacing Oven Lights.....	21
Troubleshooting	21
Service Information	22
Warranty	23

Warnings

Warning and Important Safety Instructions appearing in this manual are not meant to cover all possible conditions and situations that may occur. Common sense, caution, and care must be exercised when installing, maintaining, or operating the appliance.

ALWAYS contact the manufacturer about problems or conditions you do not understand.

Recognize Safety Symbols, Words, Labels

⚠ DANGER
Hazards or unsafe practices which WILL result in death or severe personal injury.
⚠ WARNING
Hazards or unsafe practices which COULD result in death or severe personal injury.
⚠ CAUTION
Hazards or unsafe practices which COULD result in minor personal injury.
All safety messages will identify the hazard, tell you how to reduce the chance of injury, and tell you what can happen if the instructions are not followed.

Read and follow all instructions before using this appliance to prevent the potential risk of fire, electric shock, personal injury, or damage to the appliance as a result of improper usage of the appliance. Use appliance only for its intended purpose as described in this manual.

To ensure proper and safe operation: Appliance must be properly installed and grounded by a qualified technician. **DO NOT** attempt to adjust, repair, service, or replace any part of your appliance unless it is specifically recommended in this manual. All other servicing should be referred to a qualified servicer. Have the installer show you the location of the gas shutoff valve and how to shut it off in an emergency. A certified technician is required for any adjustments or conversions to Natural or LP gas.

KEEP THESE INSTRUCTIONS FOR FUTURE REFERENCE

If the information in this manual is not followed exactly, a fire or explosion may result causing property damage, personal injury or death.

WHAT TO DO IF YOU SMELL GAS:

- **DO NOT** try to light any appliance.
- **DO NOT** touch any electrical switch.
- **DO NOT** use any phone in your building.
- Immediately call your gas supplier from a neighbor's phone. Follow the gas supplier's instructions.
- If you cannot reach your gas supplier, call the fire department.

Installation and service must be performed by a qualified installer, service agency or the gas supplier.

⚠ WARNING

TIPPING HAZARD
To reduce the risk of the appliance tipping, it must be secured by a properly installed anti-tip bracket(s). To make sure the bracket has been installed properly, look behind the range with a flashlight to verify proper installation engaged in the rear top left corner of the range.

- THIS RANGE CAN TIP
- INJURIES TO PERSONS CAN RESULT
- INSTALL ANTI-TIP DEVICE PACKED WITH RANGE
- SEE INSTALLATION INSTRUCTIONS

⚠ WARNING

To avoid risk of property damage, personal injury or death; follow information in this manual exactly to prevent a fire or explosion. **DO NOT** store or use gasoline or other flammable vapors and liquids in the vicinity of this or any appliance.

⚠ WARNING

NEVER use appliance as a space heater to heat or warm a room to prevent potential hazard to the user and damage to the appliance. Also, **DO NOT** use the rangetop or oven as a storage area for food or cooking utensils.

⚠ WARNING

ELECTRICAL SHOCK HAZARD

DO NOT touch a hot oven light bulb with a damp cloth as the bulb could break. Should the bulb break, disconnect electric power to the appliance at the main fuse or circuit breaker before removing bulb to avoid electrical shock.

⚠ WARNING

NEVER cover any slots, holes or passages in the oven bottom or cover an entire rack with materials such as aluminum foil. Doing so blocks air flow through the oven and may cause carbon monoxide poisoning. Aluminum foil linings may also trap heat, causing a fire hazard.

⚠ WARNING

BURN OR ELECTRICAL SHOCK HAZARD

Make sure all controls are OFF and oven is COOL before cleaning. Failure to do so can result in burns or electrical shock

Warnings

To Prevent Fire or Smoke Damage

- Be sure all packing materials are removed from the appliance before operating it.
- Keep area around appliance clear and free from combustible materials, gasoline, and other flammable vapors and materials.
- If appliance is installed near a window, proper precautions should be taken to prevent curtains from blowing over burners.
- NEVER** leave any items on the rangetop. The hot air from the vent may ignite flammable items and may increase pressure in closed containers which may cause them to burst.
- Many aerosol-type spray cans are **EXPLOSIVE** when exposed to heat and may be highly flammable. Avoid their use or storage near an appliance.
- Many plastics are vulnerable to heat. Keep plastics away from parts of the appliance that may become warm or hot. **DO NOT** leave plastic items on the rangetop as they may melt or soften if left too close to the vent or a lighted surface burner.
- Combustible items (paper, plastic, etc.) may ignite and metallic items may become hot and cause burns. **DO NOT** pour spirits over hot foods. **DO NOT** leave oven unsupervised when drying herbs, breads, mushrooms, etc; fire hazard.

In Case of Fire

Turn off appliance and ventilating hood to avoid spreading the flame. Extinguish flame then turn on hood to remove smoke and odor.

- Cooktop: Smother fire or flame in a pan with a lid or cookie sheet.
- NEVER** pick up or move a flaming pan.
- Oven: Smother fire or flame by closing the oven door. **DO NOT** use water on grease fires. Use baking soda, a dry chemical or foam-type extinguisher to smother fire or flame.
- GREASE**—Grease is flammable and should be handled carefully. **DO NOT** use water on grease fires. Flaming grease can be extinguished with baking soda or, if available, a multipurpose dry chemical or foam type extinguisher. Let fat cool before attempting to handle it. **DO NOT** allow grease to collect around the oven or in vents. Wipe up spillovers immediately.

Child Safety

- NEVER** leave children alone or unsupervised near the appliance when it is in use or is still hot.
- NEVER** allow children to sit or stand on any part of the appliance as they could be injured or burned.
- DO NOT** store items of interest to children over the unit. Children climbing to reach items could be seriously injured.
- Children must be taught that the appliance and utensils in it can be hot. Let hot utensils cool in a safe place, out of reach of small children. Children should be taught that an appliance is not a toy. Children should not be allowed to play with controls or other parts of the appliance.

Cooking Safety

- To eliminate the hazard of reaching over hot surface burners, cabinet storage should not be provided directly above a unit. If storage is provided, it should be limited to items which are used infrequently and which are safely stored in an area subjected to heat from an appliance. Temperatures may be unsafe for some items, such as volatile liquids, cleaners or aerosol sprays.
- ALWAYS** place a pan on a surface burner before turning it on. Be sure you know which knob controls which surface burner. Make sure the correct burner is turned on and that the burner has ignited. When cooking is completed, turn burner off before removing pan to prevent exposure to burner flame.
- ALWAYS** adjust surface burner flame so that it does not extend beyond the bottom edge of the pan. An excessive flame is hazardous, wastes energy and may damage the appliance, pan or cabinets above the appliance. This is based on safety considerations.
- NEVER** leave a surface cooking operation unattended especially when using a high heat setting or when deep fat frying. Boilovers cause smoking and greasy spillovers may ignite. Clean up greasy spills as soon as possible. **DO NOT** use high heat for extended cooking operations.
- DO NOT** heat unopened food containers, build up of pressure may cause the container to explode and result in injury.
- Use dry, sturdy pot-holders. Damp pot-holders may cause burns from steam. Dishtowels or other substitutes should **NEVER** be used as potholders because they can trail across hot surface burners and ignite or get caught on appliance parts.
- ALWAYS** let quantities of hot fat used for deep fat frying cool before attempting to move or handle.
- DO NOT** let cooking grease or other flammable materials accumulate in or near the appliance, hood or vent fan. Clean hood frequently to prevent grease from accumulating on hood or filter. When flaming foods under the hood, turn the fan off.
- NEVER** wear garments made of flammable material or loose fitting or long-sleeved apparel while cooking. Clothing may ignite or catch utensil handles. **DO NOT** drape towels or materials on oven door handles. These items could ignite and cause burns.
- ALWAYS** place oven racks in the desired positions while oven is cool. Slide oven rack out to add or remove food, using dry, sturdy potholders. **ALWAYS** avoid reaching into the oven to add or remove food. If a rack must be moved while hot, use a dry potholder.
- ALWAYS** turn the oven off at the end of cooking.
- Use care when opening the oven door. Let hot air or steam escape before moving or replacing food.
- NEVER** use aluminum foil to cover oven racks or oven bottom. This could result in risk of electric shock, fire, or damage to the appliance. Use foil only as directed in this guide.
- PREPARED FOOD WARNING:** Follow food manufacturer's instructions. If a plastic frozen food container and/or its cover distorts, warps, or is otherwise damaged during cooking, immediately discard the food and its container. The food could be contaminated.
- If you are "flaming" liquor or other spirits under an exhaust, **TURN THE FAN OFF**. The draft could cause the flames to spread out of control.

Warnings

Cooking Safety (con't)

•Once the unit has been installed as outlined in the *Installation Instructions*, it is important that the fresh air supply is not obstructed. The use of a gas cooking appliance results in the production of heat and moisture in the room in which it is installed. Ensure that the kitchen is well-ventilated. Keep natural venting holes open or install a mechanical ventilation device. Prolonged or intensive use of the appliance may call for additional (such as opening a window) or more effective ventilation (such as increasing the level of a mechanical ventilation if present).

Utensil Safety

- Use pans with flat bottoms and handles that are easily grasped and stay cool. Avoid using unstable, warped, easily tipped or loose-handled pans. Also avoid using pans, especially small pans, with heavy handles as they could be unstable and easily tip. Pans that are heavy to move when filled with food may also be hazardous.
- Be sure utensil is large enough to properly contain food and avoid boilovers. Pan size is particularly important in deep fat frying. Be sure pan will accommodate the volume of food that is to be added as well as the bubble action of fat.
- To minimize burns, ignition of flammable materials and spillage due to unintentional contact with the utensil, **DO NOT** extend handles over adjacent surface burners. **ALWAYS** turn pan handles toward the side or back of the appliance, not out into the room where they are easily hit or reached by small children.
- NEVER** let a pan boil dry as this could damage the utensil and the appliance.
- Follow the manufacturer's directions when using ovencooking bags.
- Only certain types of glass, glass/ceramic, ceramic or glazed utensils are suitable for rangetop surface or oven usage without breaking due to the sudden change in temperature. Follow manufacturer's instructions when using glass.
- This appliance has been tested for safe performance using conventional cookware. **DO NOT** use any devices or accessories that are not specifically recommended in this guide, such as eyelid covers for the surface units, stovetop grills, or add-on oven convection systems. The use of devices or accessories that are not expressly recommended in this manual can create serious safety hazards, result in performance problems, and reduce the life of the components of the appliance.
- The flame of the burner should be adjusted to just cover the bottom of the pan or pot. Excessive burner setting may cause scorching of adjacent counter-top surfaces, as well as the outside of the utensil. This is based on safety considerations.

Induction – Radio Interference

This unit generates, uses, and can radiate radio frequency energy and, if not installed and used in accordance with the instructions, may cause harmful interference to radio communications. However, there is no guarantee that interference will not occur in a particular installation. If this unit does cause harmful interference to radio or television reception, which can be determined by turning the unit off and on, the user is encouraged to try to correct the interference by one or more of the following measures:

- Reorient or relocate the receiving antenna
- Increase the distance between the unit and receiver
- Connect the unit into an outlet on a circuit different from that to which the receiver is connected.

Heating Elements

- NEVER** touch oven heating elements areas or interior surfaces of oven while cooking.
- Elements may be hot even though they are dark in color. Areas near elements and interior surfaces of an oven may become hot enough to cause burns.
- During and after use, **DO NOT** touch or let clothing or other flammable materials contact heating elements, areas near elements, or interior surfaces of oven until they have had sufficient time to cool. Other surfaces of the oven may become hot enough to cause burns, such as the oven vent opening, the surface near the vent opening, and the oven door window.

Cleaning Safety

- Turn off all controls and wait for appliance parts to cool before touching or cleaning them. **DO NOT** touch the burner grates or surrounding areas until they have had sufficient time to cool.
- Clean appliance with caution. Use care to avoid steam burns if a wet sponge or cloth is used to wipe spills on a hot surface. Some cleaners can produce noxious fumes if applied to a hot surface.
- DO NOT** clean door gasket. It is essential for a good tight seal. Care should be taken not to rub, damage, or move the gasket.
- No oven liner protective coating such as aluminum foil should be used in or around any part of the oven. Improper oven liners may result in a risk of electric shock or fire. Keep oven free from grease buildup.

Important notice regarding pet birds:

NEVER keep pet birds in the kitchen or in rooms where the fumes from the kitchen could reach. Birds have a very sensitive respiratory system. Fumes released due to overheated cooking oil, fat, margarine and overheated non-stick cookware may be equally harmful.

Before Using Your Range

All products are wiped clean with solvents at the factory to remove any visible signs of dirt, oil, and grease which may have remained from the manufacturing process. Before starting to cook, clean the range thoroughly with hot, soapy water. There may be some burn off and odors on first use of the appliance—this is normal.

Oven

Important! Before first use, wipe interior with soapy water and dry thoroughly. Then set the oven selector to bake, the thermostat to 450°F, and operate for an hour.

All models include:

- Restaurant style sealed burner system for commercial-type performance
- Variable simmer setting for all burners provides gentle, even simmering
- Heavy duty cast iron burner grates
- All burners equipped with spark ignition system with automatic re-ignition for consistent and reliable ignition
- Large capacity electric oven
- Nine high performance cooking functions include proof, bake, convection bake, broil, convection broil, and defrost
- A convection fan which allows you to cook foods more thoroughly and evenly—even when baking large quantities
- Three oven lights for better visibility
- Six rack positions with easy glide racks ensures heavy pans are easily moved

Oven Functions and Settings

Preheat - For best results, it is recommended that you preheat your oven to desired cooking temperature before placing food items in the oven. Partial power from the top broil element and full power from the bake element is used to bring the oven to the preheat temperature.

Proof - Only the light bulbs operate. This will maintain the interior oven temperature between 90 and 105°F which is ideal for all types of yeast breads.

Bake - Full power heat is radiated from the element in the bottom of the oven cavity. This function is recommended for single rack baking. Conventional baking/roasting is particularly suitable for dishes that require a high temperature. Use this setting for baking, roasting, and casseroles.

Convection Bake - Full power heat is radiated from the element in the bottom of the oven cavity with the addition of a motorized fan in the rear of the oven. This function provides a more even heat distribution by circulating air throughout the cavity and eliminates hot and cold spots found in conventional baking. Convection baking has the ability to prepare food in quantity using multiple racks.

TruConvex - Only the rear element around the motorized fan operates at full power. There is no direct heat from the bottom or top elements. Use this setting for foods that require gentle cooking such as pastries, souffles, yeast breads, quick breads and cakes.

Defrost - Air is circulated by a motorized fan in the rear of the oven. There is no heat from any of the elements. The fan accelerates natural defrosting of the food without heat. To avoid sickness and food waste, do not allow defrosted food to remain in the oven for more than two hours.

Broil - Broiling is a dry-heat cooking method using direct heat from the top element. It is used for small, individualized cuts such as steaks, chops and broiling. Broiling speed is determined by the distance between the food and the broil element.

Convection Broil - the top element operates at full power with the additional benefit of air circulation by the motorized fan in the rear of the oven. Use this setting for broiling thick cuts of meats.

Manual Timer - TVDR6616G Model Only. Turn knob to desired cooking time. Timer will count down and “ding” when it reaches OFF. Timer has no connection to any baking functions.

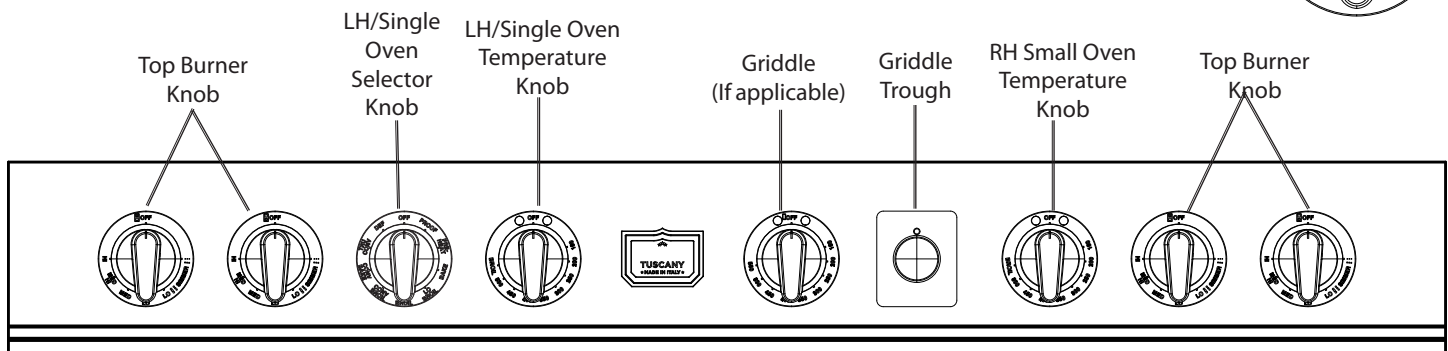
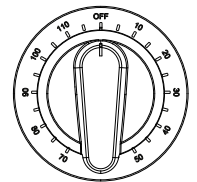

Range Features

36" W / 4 Surface Burners

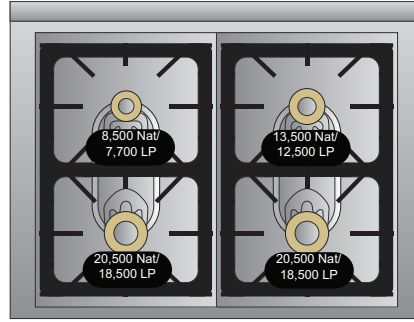

48" W / 6 Surface Burners

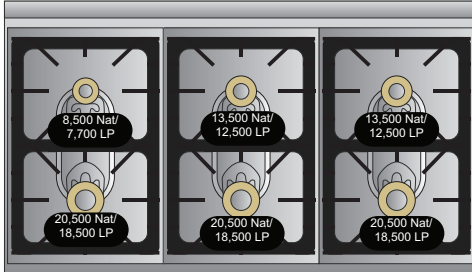

48" W / 4 Surface Burners/Griddle

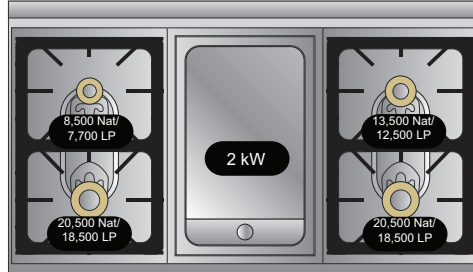

48" W / 4 Surface Burners/Induction

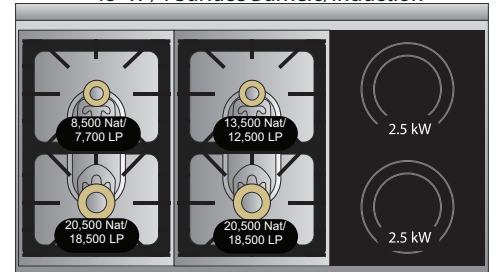

66" W / 8 Surface Burners

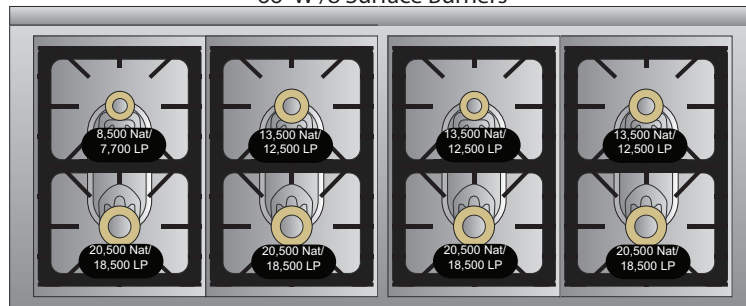

66" W / 6 Surface Burners/Griddle

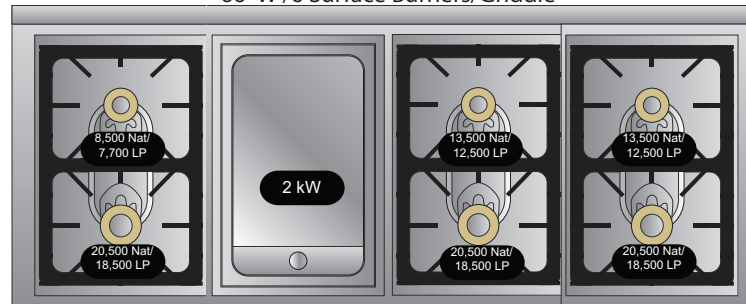

66" W / 6 Surface Burners/Induction

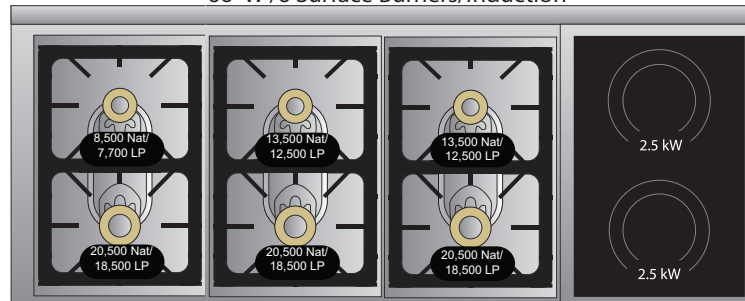

Surface Operation

All ranges are equipped with an exclusive restaurant style sealed burner system. This unique burner system is equipped with three different size burners ranging from 8,500 to 20,500 BTUs.

The 20,500 BTU burners are designed to provide extra high heat output, especially when using large pans, and should be used for boiling large quantities or if you need to bring something to a boil quickly. While the high output burners have the extra power needed to bring large quantities of liquid to a boil rapidly, they are also able to be turned down low enough to provide a very low and delicate simmer making this the most versatile burner system.

Lighting Gas Burners

All burners are ignited by electric ignition. There are no open-flame, "standing" pilots.

To light the surface burners, choose the appropriate control knob.

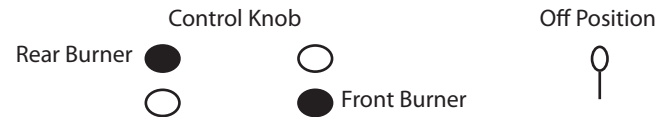

Push and turn the control knob **counter clockwise** to any position between high and simmer.

Gas Surface Burners-Automatic Re-ignition

This control is both a gas valve and an electric switch. Burners will ignite at any "ON" position with the automatic re-ignition system. If the flame goes out for any reason, the burners will automatically reignite if the gas is still flowing. When gas is permitted to flow to the burners, the electric igniters start sparking. On all surface igniters you should hear a "clicking" sound. If you do not, turn off the control and check that the unit is plugged in and that the fuse or circuit breaker is not blown or tripped.

Within a few moments, enough gas will have traveled to the burner to light. When the burner lights, turn the burner control to any position to adjust the flame size. Setting the proper flame height for the desired cooking process and selecting the correct cooking vessel will result in superior cooking performance, while also saving time and energy.

Variable Simmer

Simmering is a cooking technique in which foods are cooked in hot liquids kept at or just barely below the boiling point of water. Simmering ensures gentler treatment than boiling to prevent food from toughening and/or breaking up. The size of the pan and the volume of food can have a significant effect on how high or low a flame is needed for simmering. For this reason, the range burners are engineered with a variable simmer setting. This setting is not just one simmer setting, but provides a variable range of simmer settings. The variable range of simmer settings allows you to adjust the flame height to achieve the best simmer depending on the type and quantity of food being simmered.

Surface Cooking Tips

- Use low or medium flame heights when cooking in vessels that are poor conductors of heat, such as glass, ceramic, and cast-iron. Reduce the flame height until it covers approximately 1/3 of the cooking vessel diameter. This will ensure more even heating within the cooking vessel and reduce the likelihood of burning or scorching the food.
- Reduce the flame if it is extending beyond the bottom of the cooking vessel. A flame that extends along the sides of the vessel is potentially dangerous, heats the utensil handle and kitchen instead of the food, and wastes energy.
- Reduce the flame height to the minimum level necessary to perform the desired cooking process. Remember that food cooks just as quickly at a gentle boil as it does at a rolling boil. Maintaining a higher boil than is necessary wastes energy, cooks away moisture, and causes a loss in food flavor and nutrient level.
- The minimum pot or pan (vessel) diameter recommended is 6" (15 cm).

Cookware

Each cook has his or her own preference for the particular cookware that are most appropriate for the type of cooking being done. Any and all cookware are suitable for use in the range and it is not necessary to replace your present domestic cookware with commercial cookware. This is a matter of personal choice. As with any cookware, yours should be in good condition and free from excessive dents on the bottom to provide maximum performance and convenience.

Note: When using big pots and/or high flames, it is recommended to use the front burners. There is more room in the front and potential cleanup at rear of appliance due to staining or discoloration will be minimized.

Surface Operation

INDUCTION (select models)

Turning on the Induction Burners

To turn on the induction burners, choose the appropriate control knob. Push and turn the control knob **clockwise** to any position between high and simmer.

Induction Cookware

Induction cooking utilizes magnetic power which reacts with iron in the base of cookware, instantly transforming the pot or pan into the heat source. The heat stops when the cookware is removed. Your cookware **MUST** have a magnetic layer of steel for your induction cooktop to operate properly. The cookware should have a flat, heavy magnetic bottom and straight sides with a diameter of 5" (13 cm) to 12" (31 cm) to accommodate the various sized elements. The induction cookware should be in good condition and free from excessive dents on the bottom to provide maximum performance and convenience. Most induction cookware will be suitable for your induction cooktop if a magnet adheres to the bottom surface. Cookware that is **NOT** suitable for your induction cooktop includes pottery, glass, aluminum, copper, bronze, and any type of cookware with a footed base.

Induction Cooking Guide - Suggested Heat Setting

Food	Start at Setting	Complete at Setting
Rice	Hi - cover, bring water to a boil	Lo - cover, finish timing according to directions
Chocolate	Lo - until melted	
Candy	Lo - cook	
Pudding, pie filling	Lo - cook according to directions	
Eggs - in shell fried poached	Hi - cover, bring to boil Hi - until pan is hot Hi - bring water to boil	OFF - let set to desired doneness Lo - Med, cook to desired doneness Lo - finish cooking
Sauces	Hi - melt fat	Lo-Med, finish cooking
Soups, stews	Hi - heat up liquid	Lo-Med, finish cooking
Vegetables	Hi - preheat skillet	Lo-Med, finish cooking until desired tenderness is reached
Breads - french toast, pancakes	Med-Hi, preheat skillet	Lo - cook to desired brownness
Cooked cereals, grits, oatmeal	Hi - cover, bring water to a boil	Lo-Med, add cereal and cook according to directions
Bacon, sausages	Hi - preheat skillet	Med - cook to desired doneness
Swiss steaks	Hi - melt fat, Med-Hi - to brown meat	Lo - add liquid, cover, simmer until tender
Chicken, fried	Hi - melt fat Med-Hi - to brown crust	Lo - cook until tender
Hamburgers, pork chops	Hi - preheat skillet	Med - to brown meat and cook to desired brownness
Pasta	Hi - bring salted water to a boil, add pasta slowly	Med - maintain boil until tender

Remember that induction cooking is instantaneous and boiling time is decreased when using the proper induction cookware.

Surface Operation

GRIDDLE/SIMMER PLATE (select models)

The optional griddle is constructed of machined steel with a chrome finish and is uniquely designed to offer excellent cooking performance as well as easy clean up. The griddle is equipped with an electronic thermostat to maintain an even temperature across the griddle once the desired temperature has been set. The griddle has a power "ON" indicator light which glows when the griddle thermostat has been turned on. This will cycle on and off as needed to indicate the thermostat is maintaining the selected temperature.

Before the griddle is used, it is important to clean the griddle with hot, soapy water, then dry. Use only heat resistant plastic or wooden utensils to avoid scratching chrome surface.

Griddle/Simmer Plate Operation

- Turn the griddle control knob counterclockwise to the desired temperature setting. The power "ON" indicator light will glow indicating the griddle thermostat is on.
- When the griddle has reached the desired temperature, the power "ON" indicator light will turn "OFF" indicating the griddle is preheated to the selected temperature.
- Routinely scrape loose food particles with a heat resistant plastic or wooden spatula during cooking to make the clean-up easier and to avoid the articles mixing with the food.
- To turn the griddle off, turn the thermostat knob clockwise to the "OFF" position.
- ALWAYS** turn to the "OFF" position when not in use and lower the heat between cooking loads.

Griddle/Simmer Plate Cooking Tips

- To prevent sticking, use liquid cooking oil or butter for eggs, pancakes, French toast, fish, and sandwiches.
- Non-stick cooking spray is not recommended as it contains a high water content that has a tendency to burn quickly.
- Corn oil is not recommended as it has a high sugar content. It will caramelize and burn on the cooking surface making removal of residue very difficult.
- IMPORTANT: **NEVER** flood a hot griddle with cold water. This thermal shock causes the griddle to warp or crack.
- ALWAYS** use heat resistant plastic or wooden utensils as metal utensils can damage the chrome surface.

Griddle/Simmer Plate Clean Up & Care

- The griddle cleans up best when it is still warm but make sure the griddle is turned off before starting to clean.
- Scrape the loose food particles into the drip tray area with a heat resistant plastic or wooden spatula and empty the griddle trough.
- Do not use abrasive materials or cleaners.
- Clean using club soda and a nylon scrub pad with hot soapy water. Rinse with warm water.
- For stubborn residues on the griddle, clean the griddle with diluted white vinegar. Use a nylon scrub pad dipped in a mixture of 1 tbsp of white vinegar and a 1/2 cup of hot water. Gently scrub the stubborn residue and rise with hot water and dry.
- When cleaning is complete, always empty and clean the griddle trough after each use. A fire hazard may occur if grease is accumulated in the trough.

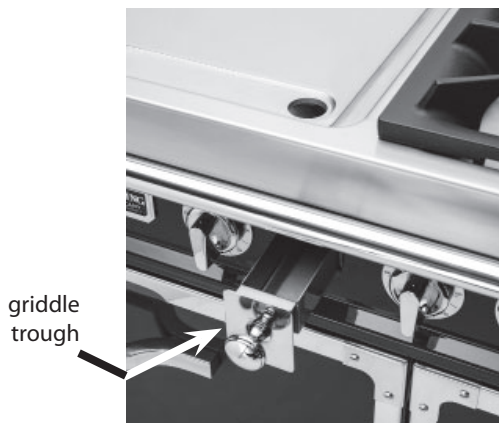

GRIDDLE COOKING CHART

Food	Temp (°F)	Temp (°C)
Eggs	250 - 300	121 - 149
Bacon	300 - 325	149 - 163
Pancakes	375 - 400	191 - 205
French toast	400	205
Fish fillets	300	149
Hamburger	350	177
Steaks	400	177

Using the Oven

⚠ WARNING

NEVER cover any slots, holes or passages in the oven bottom or cover an entire rack with materials such as aluminum foil. Doing so blocks air flow through the oven and may cause carbon monoxide poisoning. Aluminum foil linings may also trap heat, causing a fire hazard.

Rack Positions

Each large oven is equipped with two racks and has six rack positions. Position 6 is the farthest from the oven bottom. Position 1 is the closest to the oven bottom. The racks can be easily removed and arranged at various levels. It is recommended that when using two racks, to bake with the racks in positions 2 and 4 or positions 3 and 5. The smaller oven is equipped with one rack and three rack positions.

Preheat

For best results, it is extremely important that you preheat your oven to the desired cooking temperature before placing food items in the oven to begin cooking. In many cooking modes, partial power from the broiler is used to bring the oven to the preheat temperature. Therefore, placing food items in the oven during the preheat mode is not recommended.

Preheat time can vary based on some external factors such as room temperature and power supply. A significantly colder room temperature or a power supply less than 240 VAC can lengthen the time it takes for the oven to reach the desired set temperature.

Pan Placement Tips

- When using large flat pans or trays that cover most of the rack, rack positions 2 or 3 produce the best results.
- Stagger pans in opposite directions when two racks and several pans are used in conventional bake. If possible, no pan should be directly above another.
- Allow 1 to 2 inches of air space around all sides of each pan for even air circulation.

Single Rack Pan Placement

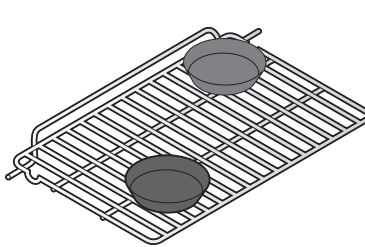

Multiple Rack Pan Placement

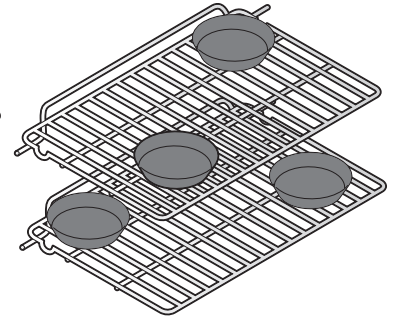

Bake

Because of variations in food density, surface texture and consistency, some foods may be prepared more successfully using the conventional bake setting. For this reason, conventional baking is recommended when preparing baked goods such as custard. The user may find other foods that are also prepared more consistently in conventional bake. It is recommended to use this function for single-rack baking.

Baking Tips

- Make sure the oven racks are in the desired position before you turn on the oven.
- DO NOT** open the door frequently during baking. If you must open the door, the best time is during the last quarter of the baking time.
- Bake to the shortest time suggested and check for doneness before adding more time. For baked goods, a stainless steel knife placed in the center of the item should come out clean when done.
- Use the pan size and type recommended by the recipe to ensure best results. Cakes, quick breads, muffins, and cookies should be baked in shiny, reflective pans for light, golden crusts. Avoid the use of old, darkened pans. Warped, dented, stainless steel and tin-coated pans heat unevenly and will not give uniform baking results.
- If baking with a large sheet pan, it is important to note that the large width of the sheet pan has the tendency to restrict the airflow in the oven cavity. It is recommended to use Convection Bake to help better circulate the heat in the oven cavity when baking with a large sheet pan.

To use BAKE function

1. Arrange the oven rack in the desired position before turning oven on.
2. Set the oven selector knob to the preheat function and set the oven temperature control knob to the desired temperature.
3. Close the door. Allow oven to preheat.
4. Once preheated, rotate the oven selector knob clockwise to the bake function. Carefully place prepared item(s) on rack.
5. Close the door. Bake to desired cooking time and/or doneness.

Using the Oven

CONVENTIONAL BAKING CHART					
Food	Pan Size	Single Rack Position (Lg Oven)	Single Rack Position (Sm Oven)	Temperature	Time (min.)
BREADS					
Biscuits	Cookie sheet	3 or 4	2	400°F (204°C)	10 - 12
Yeast loaf	Loaf pan	3 or 4	2	375°F (191°C)	30 - 35
Yeast rolls	Cookie sheet	3 or 4	2	400°F (204°C)	12 - 15
Nut bread	Loaf pan	3 or 4	2	375°F (191°C)	30 - 35
Cornbread	8" x 8"	3 or 4	2	400°F (204°C)	25 - 30
Gingerbread	8" x 8"	3 or 4	2	350°F (177°C)	35 - 40
Muffins	Muffin tin	3 or 4	2	375°F (191°C)	15 - 20
Corn Muffin	Muffin tin	3 or 4	2	375°F (191°C)	15 - 20
CAKES					
Angel food	Tube pan	3 or 4	2	375°F (191°C)	35 - 45
Bundt	Tube pan	3 or 4	2	350°F (177°C)	45 - 55
Cupcakes	Muffin pan	3 or 4	2	350°F (177°C)	16 - 20
Layer, sheet	13" x 9"	3 or 4	2	350°F (177°C)	40 - 50
Layer, two	9" round	3 or 4	2	350°F (177°C)	30 - 35
Pound	Loaf pan	3 or 4	2	350°F (177°C)	60 - 65
COOKIES					
Brownies	13" x 9"	3 or 4	2	350°F (177°C)	25 - 30
Chocolate Chip	Cookie sheet	3 or 4	2	375°F (191°C)	12 - 15
Sugar	Cookie sheet	3 or 4	2	375°F (191°C)	10 - 12
PASTRY					
Cream puffs	Cookie sheet	3 or 4	2	400°F (204°C)	30 - 35
PIES					
Crust, unfilled	9" round	3 or 4	2	400°F (204°C)	10 - 12
Crust, filled	9" round	3 or 4	2	350°F (177°C)	55 - 60
Lemon meringue	9" round	3 or 4	2	350°F (177°C)	12 - 15
Pumpkin	9" round	3 or 4	2	350°F (177°C)	35 - 40
Custard	6-4 oz. cups	3 or 4	2	350°F (177°C)	35 - 40
ENTREES					
Egg rolls	Cookie sheet	3 or 4	2	400°F (204°C)	25 - 30
Fish sticks	Cookie sheet	3 or 4	2	425°F (218°C)	10 - 15
Lasagna, frozen	Cookie sheet	3 or 4	2	375°F (191°C)	55 - 60
Pot pie	Cookie sheet	3 or 4	2	400°F (204°C)	35 - 40
Green peppers, stuffed	13" x 9"	3 or 4	2	375°F (191°C)	60 - 70
Quiche	9" round	3 or 4	2	400°F (204°C)	25 - 30
Pizza, 12"	Cookie sheet	3 or 4	2	400°F (204°C)	15 - 20
Mac & cheese, frz	Cookie sheet	3 or 4	2	375°F (191°C)	35 - 40
VEGETABLES					
Baked potato	On rack	3 or 4	2	375°F (191°C)	60 - 65
Spinach souffle	1 quart	3 or 4	2	350°F (177°C)	45 - 50
Squash	casserole	3 or 4	2	375°F (191°C)	50 - 55
French fries	Cookie sheet	3 or 4	2	425°F (218°C)	20 - 25

**Note: The above information is given as a guide only.*

Using the Oven

Convection Bake

Convection cooking is a cooking technique which utilizes fan forced air to circulate heat throughout the entire oven creating the optimum cooking environment. Cooking with convection is recommended when performing multi-rack baking and for baking heavier foods. Below are tips which will allow you to get the best results out of our oven when cooking with convection.

Convection Cooking Tips

- As a general rule, to convert conventional recipes to convection recipes, reduce the temperature by 25°F (10°C) when using a convection cooking function.
- Cooking times for standard baking and convection baking will be the same. However, if using convection to cook a single item or smaller load, then it is possible to have 10-15% reduction in cooking time. (Remember convection cooking is designed for multi-rack baking or cooking large loads.)
- If cooking items which require longer than 45 minutes, then it is possible to see a 10-15% reduction in cooking time.
- A major benefit of convection cooking is the ability to prepare foods in quantity. The uniform air circulation makes this possible. Foods that can be prepared on two or three racks at the same time include: pizza, cakes, cookies, biscuits, muffins, rolls, and frozen convenience foods.
- Items cooked in a convection function can be easily over-baked. This being the case, it is usually a good idea to pull items out of the oven just before they seem to be done. Items will continue to cook right after they are set out of the oven.

To use CONVECTION BAKE function

1. Arrange the oven rack in the desired position before turning oven on.
2. Set the oven selector knob to the convection bake function, and set the oven temperature control knob to desired temperature.
3. Close the door. Allow oven to preheat.
4. Once preheated, carefully place prepared item(s) on rack.
5. Close the door. Bake to desired cooking time and/or doneness.

Using the Oven

CONVECTION BAKING CHART				
Food	Pan Size	Single Rack Position (Lg Oven)	Temperature	Time (min.)
BREADS				
Biscuits	Cookie sheet	3 or 4	375°F (191°C)	7 - 9
Yeast loaf	Loaf pan	3 or 4	375°F (191°C)	25 - 30
Yeast rolls	Cookie sheet	3 or 4	375°F (191°C)	11 - 13
Nut bread	Loaf pan	3 or 4	350°F (177°C)	25 - 30
Cornbread	8" x 8"	3 or 4	375°F (191°C)	20 - 25
Gingerbread	8" x 8"	3 or 4	325°F (163°C)	30 - 35
Muffins	Muffin tin	3 or 4	350°F (177°C)	12 - 15
Corn Muffin	Muffin tin	3 or 4	350°F (177°C)	10 - 12
CAKES				
Angel food	Tube pan	3 or 4	350°F (177°C)	35 - 45
Bundt	Tube pan	3 or 4	325°F (163°C)	45 - 55
Cupcakes	Muffin pan	3 or 4	325°F (163°C)	16 - 20
Layer, sheet	13" x 9"	3 or 4	325°F (163°C)	40 - 50
Layer, two	9" round	3 or 4	325°F (163°C)	30 - 35
Pound	Loaf pan	3 or 4	325°F (163°C)	60 - 65
COOKIES				
Brownies	13" x 9"	3 or 4	325°F (163°C)	20 - 25
Chocolate Chip	Cookie sheet	3 or 4	350°F (177°C)	7 - 10
Sugar	Cookie sheet	3 or 4	350°F (177°C)	7 - 10
PASTRY				
Cream puffs	Cookie sheet	3 or 4	400°F (204°C)	30 - 35
PIES				
Crust, unfilled	9" round	3 or 4	375°F (191°C)	7 - 9
Crust, filled	9" round	3 or 4	325°F (163°C)	50 - 55
Lemon meringue	9" round	3 or 4	325°F (163°C)	10 - 12
Pumpkin	9" round	3 or 4	325°F (163°C)	45 - 55
Custard	6-4 oz. cups	3 or 4		
ENTREES				
Egg rolls	Cookie sheet	3 or 4	375°F (191°C)	15 - 20
Fish sticks	Cookie sheet	3 or 4	400°F (204°C)	8 - 10
Lasagna, frozen	Cookie sheet	3 or 4	350°F (177°C)	45 - 50
Pot pie	Cookie sheet	3 or 4	350°F (177°C)	35 - 40
Green peppers, stuffed	13" x 9"	3 or 4	350°F (177°C)	45 - 50
Quiche	Not recommended			
Pizza, 12"	Cookie sheet	3 or 4	375°F (191°C)	15 - 20
Mac & cheese, frz	Cookie sheet	3 or 4	350°F (177°C)	25 - 35
VEGETABLES				
Baked potato	On rack	3 or 4	350°F (177°C)	50 - 55
Spinach souffle	1 quart casserole	3 or 4	325°F (163°C)	35 - 40
Squash	Cookie sheet	3 or 4	350°F (177°C)	40 - 45
French fries	Cookie sheet	3 or 4	400°F (204°C)	15 - 20

**Note: The above information is given as a guide only.*

Using the Oven

Solving Baking Problems

Baking problems can occur for many reasons. Check the chart below for the causes and remedies for the most common problems. It is important to remember that the temperature setting and cooking times you are accustomed to using with your previous oven may vary slightly from those required with this oven. If you find this to be true, it is necessary for you to adjust your recipes and cooking times accordingly.

COMMON BAKING PROBLEMS/REMEDIES		
Problems	Cause	Remedy
Cakes burned on the sides or not done in center	<ol style="list-style-type: none"> 1. Oven was too hot 2. Wrong size pan 3. Too many pans 	<ol style="list-style-type: none"> 1. Reduce temperature 2. Use recommended pan size 3. Reduce number of pans
Cakes crack on top	<ol style="list-style-type: none"> 1. Batter too thick 2. Oven too hot 3. Wrong pan size 	<ol style="list-style-type: none"> 1. Follow recipe, add liquid 2. Reduce temperature 3. Use recommended pan size
Cakes are not level	<ol style="list-style-type: none"> 1. Batter uneven 2. Oven or rack not level 3. Pan was warped 	<ol style="list-style-type: none"> 1. Distribute batter evenly 2. Level oven or rack 3. Use proper pan
Food too brown on bottom	<ol style="list-style-type: none"> 1. Oven door opened too often 2. Dark pans being used 3. Incorrect rack positions 4. Wrong bake setting 5. Pan too large 	<ol style="list-style-type: none"> 1. Use door window to check food 2. Use shiny pans 3. Use recommended rack position 4. Adjust to conventional or convection setting as needed. 5. Use proper pan
Food too brown on top	<ol style="list-style-type: none"> 1. Rack position too high 2. Oven not preheated 3. Sides of pan too high 	<ol style="list-style-type: none"> 1. Use recommended rack position 2. Allow oven to preheat 3. Use proper pans
Cookies too flat	<ol style="list-style-type: none"> 1. Hot cookie sheet 	<ol style="list-style-type: none"> 1. Allow sheet to cool between batches
Pies burned around edges	<ol style="list-style-type: none"> 1. Oven too hot 2. Too many pans used 3. Oven not preheated 	<ol style="list-style-type: none"> 1. Reduce temperature 2. Reduce number of pans 3. Allow oven to preheat
Pies too light on top	<ol style="list-style-type: none"> 1. Oven not hot enough 2. Too many pans used 3. Oven not preheated 	<ol style="list-style-type: none"> 1. Increase temperature 2. Reduce number of pans 3. Allow oven to preheat

Using the Oven

TruConvection

The rear element only operates at full power. There is no direct heat from the bottom or top elements. The motorized fan in the rear of the oven circulates air in the oven cavity for even heating. Use this setting for foods that require gentle cooking such as pastries, souffles, yeast breads, quick breads and cakes. Breads, cookies, and other baked goods come out evenly textured with golden crusts. No special bakeware is required. Use this function for single rack baking, multiple rack baking, roasting, and preparation of complete meals. This setting is also recommended when baking large quantities of baked goods at one time.

Proof

This setting is designed for allowing yeast dough to rise to a temperature between 85°F (29°C) and 100°F (38°C). Yeast doughs rise or “proof” best when the temperature is between 85°F (29°C) and 100°F (38°C). To make sure the dough is warm enough, cover the bowl loosely with plastic wrap and/or cloth towel. Turn the oven function selector to “PROOF”. Turn Temperature control until the oven light comes on (typically around 200 degrees on the knob setting). Note that the Proof function is designed to keep the oven between 85°F and 100°F regardless of what temperature the knob is set at. Place the bowl on the center rack of the oven and close door. When you think the dough has doubled in size, lightly poke 2 fingers about 1/2” (1.3 cm) into the dough. If the indentation remains, the dough has risen enough.

Defrost

Air is circulated by a motorized fan in the rear of the oven with no heat from the elements. The fan accelerates natural defrosting of the food without heat.

1. Place frozen food on a baking sheet.
2. Set the selector knob to Defrost.

WARNING

To avoid sickness and food waste, Do Not allow defrosted food to remain in the oven for more than two hours.

Using the Oven

Broil / Convection Broil

Broiling is a dry-heat cooking method using direct or radiant heat. It is used for small, individualized cuts such as steaks, chops, and patties. Broiling speed is determined by the distance between the food and the broil element. Choose the rack position based on desired results.

Conventional broiling is most successful for cuts of meat 1-2 inches thick and is also more suitable for flat pieces of meat. Convection broiling has the advantage of broiling food slightly quicker than conventional. Convection broiling of meats produces better results, especially for thick cuts. The meat sears on the outside and retains more juices and natural flavor inside with less shrinkage.

To Use Broil or Convection Broil

1. Arrange the oven rack in the desired position before turning broiler on.
2. Center the food on a cold broiler pan and grid. Place broiler pan in oven.
3. Set the oven temperature control knob to Broil or Convection Broil
4. Close the door. There is not a detent to hold the door in the open broil stop position. With open door broiling the broil element does not cycle on and off. With closed door broiling the broil element might cycle on and off if an extended broiling time is required.

Broiling Tips

- **ALWAYS** use a broiler pan and grid for broiling. They are designed to provide drainage of excess liquid and fat away from the cooking surface to help prevent splatter, smoke, and fire.
- To keep meat from curling, slit fatty edge.
- Brush chicken and fish with butter several times as they broil to prevent drying out. To prevent sticking, lightly grease broiler tray.
- Broil on first side for slightly more than half the recommended time, season, and turn. Season second side just before removing.
- **ALWAYS** pull rack out to stop position before turning or removing food.
- Use tongs or a spatula to turn meats. Do not pierce meat with a fork, as this allows the juices to escape.
- Remove the broiler pan from the oven when you remove the food. Drippings will bake onto the pan if it is left in the heated oven after broiling. While pan is hot, place damp paper towel over grid. Drizzle with liquid dishwashing detergent and pour water over grid. This will make cleaning of the pan easier, or the broiler pan can be lined with aluminum foil to make cleaning easier. Be sure the foil extends up the side of the pan.

BROILING CHART				
Type and Cut of Meat	Weight	Setting	Rack	Time (min.)
BEEF				
Sirloin, 1"				
Rare	12 oz.	Broil	3	4
Medium	12 oz.	Broil	3	5
Well done	12 oz.	Broil	3	6
T-Bone, 3/4"				
Rare	10 oz.	Broil	3	4
Medium	10 oz.	Broil	3	6
Well done	10 oz.	Broil	3	8
Hamburger, 1/2"				
Medium	1/4 lb.	Broil	3	6
Well done	1/4 lb.	Broil	3	8
CHICKEN				
Boneless breast, 1"	1/2 lb.	Broil	3	15
Boneless breast, 1"	1/2 lb.	Convection Broil	3	15
Bone-in breast	2 - 3 lbs. total	Broil	1	22
Bone-in breast	2 - 3 lbs. total	Convection Broil	1	20
Chicken pieces	2 - 3 lbs. total	Broil	3	22
Chicken pieces	2 - 3 lbs. total	Convection Broil	3	20
HAM				
Ham slice, 1"	1 lb.	Broil	3	10
LAMB				
Rib chops	12 oz.	Convection Broil	2	8
PORK				
Loin chops, 3/4"	1 lb.	Convection Broil	2	10
Bacon		Broil	2	3
FISH				
Salmon steak	1 lb.	Broil	2	8
Fillet	1 lb.	Broil	2	8

Cleaning and Maintenance

Any piece of equipment works better and lasts longer when maintained properly and kept clean. Cooking equipment is no exception. Your range must be kept clean and maintained properly. Before cleaning, make sure all controls are in the "OFF" position. Disconnect power if you are going to clean thoroughly with water.

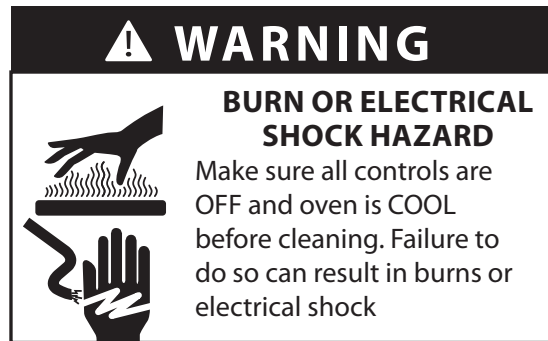

Surface Burners

Wipe up spill-overs as soon as possible after they occur and before they get a chance to burn in and cook solid.

In the event of a spill-over, follow these steps:

- Allow the burner and grate to cool to a safe temperature level.
- Lift off the burner grate. Wash in warm soapy water.
- Remove the burner head and clean.

Grates

After cooking, always wipe down grates and burner caps with a damp sponge and dry thoroughly. Normal cleaning can be done with hot, soapy water and/or Soft Scrub cleanser (without bleach) with a blue Scotch-Brite pad.

When cleaning grates, make sure to thoroughly dry them, especially underneath. If the bottom portion does not totally dry before setting them back on the cooking surface, they may rust. You can also set the grates on top of the burner and turn the burner on high for ten to fifteen seconds for extra drying. To prevent rusting and discoloration, do not submerge grates in water soak for any length of time or run them through the dishwasher. If rust does occur, Bar Keeper's Friend and a blue Scotch-Brite pad will remove it. To condition grates, apply a light coating of mineral oil or vegetable oil. Allow oil to soak in 15 minutes before returning to cooking surface.

Burner Head

If ports on burner head are clogged, clean with a straight pin. **DO NOT** enlarge or distort the ports. **DO NOT** use a toothpick to clean the ports.

Note: For stubborn stains, use a non abrasive cleanser such as Bon Ami™ and a soft brush or soft Scotch Brite™ pad or place burner heads in a zip seal bag with ammonia.

Burner Base

The base should be wiped regularly with hot soapy water at the end of each cooling period. **DO NOT** use steel wool, abrasive cloths, cleanser, or powders. To remove encrusted materials, soak the area with a hot towel to loosen the material, then use a wooden or nylon spatula. **DO NOT** use a metal knife, spatula, or any other metal tool to scrape the base.

- Wipe up any spills which remain on the sealed top surface.
- Replace burner head, and grates after drying thoroughly.

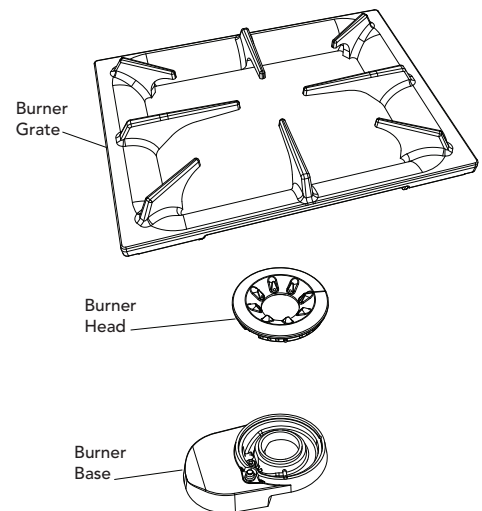

Cleaning and Maintenance

Control Panel

DO NOT use any cleaners containing ammonia or abrasives. They could remove the graphics from the control panel. Use hot, soapy water and a soft clean cloth.

Control Knobs

MAKE SURE ALL THE CONTROL KNOBS POINT TO THE "OFF" POSITION BEFORE REMOVING.

Pull the knobs straight off. Wash in detergent and warm water. Dry completely and replace by pushing firmly onto stem. **DO NOT** use any cleaners containing ammonia or abrasives.

Stainless Steel Oven Cavity and Exterior Stainless Steel Parts

Your range is equipped with a heavy-duty stainless steel oven cavity which is the same as what is commonly used in commercial and restaurant style ranges. Over time they will naturally start to darken and discolor. This is the standard process of how stainless steel reacts when it is exposed to high heat temperatures. The discoloration of the oven will not affect the performance. While the stainless steel oven cavity will never return to the original color, there are some steps which can be taken to help minimize the discoloration of these components. To ensure that the stainless steel maintains adequate corrosion resistance, it should be cleaned regularly. Surface contaminants vary in terms of corrosiveness, effect on surface finish, and ease of removal. The mildest form of cleaning should always be used first.

To clean a lightly soiled surface:

•It is recommended to use warm water, a mild, non-abrasive detergent, and a soft cloth while rubbing in the direction of the stainless steel grain.

For more highly soiled/discolored surfaces:

- It is recommended to use the soft cleanser version of Bar Keepers Friend. Simply read and follow the directions found on product label.
- To prevent corrosion of the metal, it is important that the cleaning solution be rinsed or wiped clean with warm water. The surface should then be wiped clean, in the direction of the stainless steel grain, with dry towels to prevent water spots.

Things to avoid when cleaning stainless steel:

- Steel brushes or steel wool
- Abrasive cleaners
- Bleach or hydrochloric acid based cleaners
- Detergents containing chloride
- Avoid using cleaning cloths that have been used on ordinary steel
- NEVER** rub against the grain with a cleaning agent or polish as it will alter the surface of the steel and reduce the corrosion resistance
- DO NOT** permit citrus or tomato juice to remain on stainless steel surface, as citric acid will permanently discolor stainless steel. Wipe up any spills immediately.

Cleaning and Maintenance

Induction Glass Top

Cleaning of glass tops is different from cleaning a standard porcelain finish. To maintain and protect the surface of your new glass top, follow these basic steps:

For normal, light soil:

1. Rub a few drops of a non-abrasive glass cleaning cream to the cool soiled area using a damp paper towel.
2. Wipe until all soil and cream are removed. Frequent cleaning leaves a protective coating which is essential in preventing scratches and abrasions.

For heavy, burned soil:

1. Rub a few drops of non-abrasive glass cleaning cream to the cool soiled area using a damp paper towel.
2. Carefully scrape remaining soil with a single-edged razor blade. Hold the blade at a 30° angle against the ceramic surface.
3. If any soil remains, repeat the steps above. For additional protection, after all soil has been removed, polish the entire surface with the cleaning cream.
4. Buff with a dry paper towel. As the cleaning cream cleans, it leaves a protective coating on the glass surface. This coating helps to prevent build-up of mineral deposits (water spots) and will make future cleaning easier.

Note: Dishwashing detergents remove this protective coating and therefore, make the glass ceramic top more susceptible to staining.

Cleaning Problems on Glass Tops

Problem	Cause	To Prevent	To Remove
Brown streaks and specks	Cleaning with sponge or cloth containing soil laden detergent water.	Use cleaning cream with clean damp paper towel.	Use a light application of cleaning cream with a clean damp paper towel.
Blackened burned on spots	Spatters or spillovers onto a hot cooking area or accidental melting of a plastic film, such as a bread bag.	Wipe all spillovers as soon as it is safe and DO NOT put plastic items on a warm cooking area.	Clean area with cleaning cream and a damp paper towel, non-abrasive nylon pad or scouring brush. If burn-on is not removed, cool cooktop, and carefully scrape area with a single-edged razor blade held at a 30° angle.
Fine brown/gray lines, fine scratches, or abrasions which have collected soil	Coarse particles (salt, sugar) can get caught on the bottom of cookware and become embedded into top. Use of abrasive cleaning materials.	Wipe the bottom of cookware before cooking. Clean top daily with cleaning cream. DO NOT use abrasive cleaning materials	Fine scratches are not removable but can be minimized by daily use of cleaning cream.
Smearing or streaking	Use of too much cleaning cream or use of a soiled dishcloth.	Use a small amount of cream. Rinse thoroughly before drying. Use only paper towels or nylon scrub pad or brush.	Dampen paper towel with a mixture of vinegar and water and wipe surface. Wipe area with damp paper towel or lint free cloth.

Replacing Oven Lights

⚠ WARNING



ELECTRICAL SHOCK HAZARD
DO NOT touch a hot oven light bulb with a damp cloth as the bulb could break. Should the bulb break, disconnect electric power to the appliance at the main fuse or circuit breaker before removing bulb to avoid electrical shock.

The lights inside the oven are located in the top near the door opening.

To replace the light bulb:

1. Locate light bulb cover in top of oven cavity.
2. Unscrew glass light cover.
3. Use oven mitt during bulb removal to protect your hand in case the bulb breaks.
4. Replace the bulb with a 230 volt, 25-watt appliance bulb.
5. Replace the light cover
6. Reconnect power at the main fuse or circuit breaker.



Troubleshooting

Problem	Possible Cause and/or Remedy
Range will not function.	Range is not connected to electrical power: Have electrician check power circuit breaker, wiring, and fuses.
Broil does not work.	Temperature control knob is rotated too far past broil position.
Oven light will not work.	Light bulb is burned out. Range is not connected to power.
Igniters will not work.	Circuit is tripped. Fuse is blown. Range is not connected to power.
Igniters sparking but no flame ignition.	Gas supply valve is in "OFF" position. Gas supply is interrupted.
Igniters sparking continuously after flame ignition.	Power supply is not grounded. Power supply polarity is reversed. Igniters are wet or dirty.
Burner ignites but flame is large, distorted, or yellow.	Burner ports are clogged. Unit is being operated on wrong type of gas. Air shutters not properly adjusted.
Strong odor and/or smoke is noticed first few times oven is used.	This is normal burn off of insulation and protective oils in oven. This will go away after using oven a few times.
Oven indicator light on; oven will not heat.	Oven is operating properly. Unit will resume heating function once it has cooled.

Service Information

If service is required, call your authorized service agency.

Have the following information readily available:

- Model number
- Serial number
- Date purchased
- Name of dealer from whom purchased

Clearly describe the problem that you are having. If you are unable to obtain the name of an authorized service agency, or if you continue to have service problems, contact 1-888-845-4641, or write to:

**VIKING RANGE, LLC
PREFERRED SERVICE**
111 Front Street
Greenwood, Mississippi 38930

To locate the serial plate, remove the storage drawer and look on the inside wall of the range.

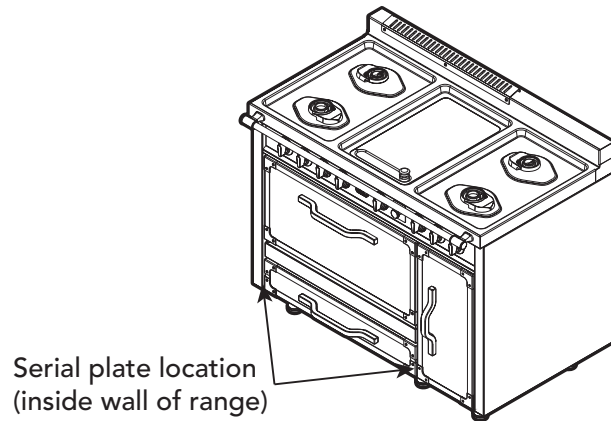

Record the following information indicated below. You will need it if service is ever required.

Model no. _____

Serial no. _____

Date of purchase _____

Date installed _____

Dealer's name _____

Address _____

If service requires installation of parts, use only authorized parts to insure protection under the warranty.

KEEP THIS MANUAL FOR FUTURE REFERENCE.

Warranty

TUSCANY DUAL FUEL RANGES WARRANTY TWO YEAR FULL WARRANTY

Freestanding dual fuel ranges and all of their component parts, except as detailed below*, are warranted to be free from defective materials or workmanship in residential household use for a period of two (2) years from the date of original retail purchase. Viking Range, warrantor, agrees to repair or replace at its option, any part which fails or is found to be defective during the warranty period. Warranty service must be performed by a Viking Range LLC authorized service agency or representative.

***90 Day Cosmetic Warranty:** Products are warranted to be free from cosmetic defects in material or workmanship for a period of 90 days from the date of original retail purchase. This warranty covers manufacturing based defects only and does not cover issues resulting from handling or installation. Inspection of the product should be made at time of delivery. Any defects must be reported to the selling dealer within the 90 day period. Viking Range LLC uses the most up to date processes and the best materials available to produce all color finishes. However, slight color variation may be noticed because of the inherent differences in painted parts and porcelain parts as well as differences in product location and natural or artificial lighting. Warranty service must be performed by a Viking Range LLC authorized service agency or representative.

***90 Day Residential Plus:** Viking products are designed and certified for residential use only. They are not intended for use in commercial applications. Viking products should only be used in accordance to national and local codes. Viking is not responsible for property damage or injury resulting from use in a commercial application.

To support the manufacturing quality of its appliance's Viking will provide a full 90 day warranty for products used in "Residential Plus" applications. This "Residential Plus" warranty applies to applications where use of the product extends beyond residential use but is in compliance with national and local code. In some jurisdictions these applications are zoned as residential. Examples of, but not limited to, such applications covered by this warranty are bed and breakfasts, fire stations, private clubs, churches, condominium/apartment common areas etc. Under this "Residential Plus" warranty, the product, its components and accessories are warranted to be free from defective material or workmanship for a period of ninety (90) days from the date of original retail purchase. Viking Range, LLC, warrantor, agrees to repair or replace, at its option, any part which fails or is found to be defective during the warranty period. This warranty covers parts and labor. This warranty excludes use of the product in all commercial locations such as restaurants, food service locations and institutional food service locations.

FIVE YEAR LIMITED WARRANTY

Any surface burner, griddle burner, oven element, or induction coil which fails due to defective materials or workmanship in normal residential use during the third thru the fifth year from the date of original retail purchase will be repaired or replaced free of charge for the part itself, with the owner paying all other costs, shipping, handling and labor. Aesthetic conditions such as corrosion, scratching, discoloration, carbon/food build up or similar blemishes due to normal wear and tear or improper use or lack of maintenance is excluded from this warranty.

WARRANTY TERMS

This warranty extends to the original retail purchaser of the product warranted hereunder and to each transferee owner of the product during the term of the original purchaser's warranty. The warranty is transferable by the original retail purchaser via home sale only. If a transferee owner is unable to provide proof of purchase from the original purchaser and the product has not been previously registered, the production date of the product, located in the serial number on the product, will serve as the effective warranty start date.

The activation date of the warranty begins from the date of original retail purchase. In the case of new product purchase via building development sales, activation begins from the earlier date of either certificate of occupancy or 24 months from date of manufacture. Note date of manufacture is identified by serial tag on product.

This warranty does not cover units purchased as b-stock, liquidation, salvage, seconds, refurbished, as-is, used products.

This warranty shall apply to products purchased in the United States and Canada. Products must be purchased in the country where service is requested. Warranty service must be performed by a Viking Range LLC authorized service agency or representative. Warranty shall not apply to damage resulting from abuse, accident, natural disaster, loss of electrical power to the product for any reason, alteration, improper installation, improper operation, or repair service of the product by anyone other than a Viking Range LLC authorized service agency or representative. This warranty does not apply to commercial usage. Warrantor is not responsible for consequential or incidental damage whether arising out of breach of warranty, breach of contract or otherwise. Some jurisdictions do not allow the exclusion or limitation of incidental or consequential damages, so the above limitations do not apply to you.

Owner shall be responsible for proper installation, providing normal care and maintenance, providing proof of purchase upon request, and making the product reasonably accessible for service. If the product or one of its component parts contains a defect or malfunction during the warranty period, after a reasonable number of attempts by the warrantor to remedy the defects or malfunctions, the owner is entitled to either a refund or replacement, at the warrantor's discretion of the product or its component part or parts. Warrantor's liability on any claim of any kind, with respect to the goods or services covered hereunder, shall in no case exceed the price of the goods or service or part thereof which gives rise to the claim.

WARRANTY SERVICE

Under the terms of this warranty, service must be performed by a Viking Range LLC authorized service agent or representative. Service will be provided during normal business hours. Labor performed at overtime or premium rates shall not be covered by the warranty. To obtain warranty service contact Viking Range LLC Customer Care at 1-888-845-4641. Please have model number, serial number, and date of original purchase available when calling. IMPORTANT: retain proof of original purchase to establish warranty period.

The return of the owner registration card is not a condition of warranty coverage. You should, however, return the owner registration card so Viking Range LLC can contact you should any question of safety arise which could affect you.

Any implied warranties of merchantability and fitness applicable to the above described burner assemblies, infrared rotisserie burners, grill grates, and stainless steel parts are limited in duration to the period of coverage of the applicable express written limited warranties set forth above. Some jurisdictions do not allow limitations on how long an implied warranty lasts, so the above limitations may not apply to you. This warranty gives you specific legal rights, and you may also have other rights which may vary from jurisdiction to jurisdiction.

Specifications subject to change without notice.

Viking Range, LLC
111 Front Street
Greenwood, Mississippi 38930
662-4551200

For more product information, call 1-888-845-4641
or visit our website at www.vikingrange.com