

This Owner's Manual is provided and hosted by [Appliance Factory Parts](#).



KAMADO JOE KJ15041021 Owner's Manual

[Shop genuine replacement parts for KAMADO JOE
KJ15041021](#)



[Find Your KAMADO JOE Grill Parts - Select From 7 Models](#)

----- Manual continues below -----

KAMADO JOE BIG JOE III OWNER'S MANUAL

**A GUIDE TO
KAMADO COOKING**

KAMADOJOE®

Table of Contents

Warnings	4
Parts List & Tools Required	8
Grill Set-Up Instructions	9
Internal Assembly Instructions	10
The Art of Kamado	12
The Fundamentals of Fire	14
The Fundamentals of Smoke	16
The Fundamentals of Distance	18
The Fundamentals of Surfaces	20
The Technique of Grilling	22
The Technique of Searing	24
The Technique of Baking	26
The Technique of Roasting	28
The Technique of Smoking	30
Classic Air Lift Hinge Adjustments	32
Safety Information	35
Cleaning & Care	36
Warranty & Registration	37
Quick Start Guide	39

Finding the Spark

What flame does to food is something hard to describe. Almost magical, fire brings out sweetness, heightens flavor, deepens complexity. The pursuit of this taste sparked my passion for grilling 20 years ago—and began a search that would lead me to the kamado tradition. I tried everything from high-end gas grills to traditional charcoal briquette grills; the smoky taste of the charcoal intrigued me, but I kept exploring. Eventually, I discovered the same tenderness and flavor that American soldiers first tasted in Japan on the kamado decades ago.

After years of cooking on a kamado grill, I decided to make my own and make it better. We focused on super-premium materials and cooking innovation; the result was Kamado Joe. Our grills are the best kamado-style cookers in the world, and beyond that, one of the best ways you can cook. With six kids in my family, I spend a lot of time cooking. And thinking about cooking. So what I love most about the Kamado Joe is its ability to make dinner something we all do together. After we launched Kamado Joe, we heard the same thing from people like you. You like the superior flavor of the food you're grilling—but more than that, you love the experience of firing up your kamado, pouring a drink and letting the cares of your day fade.

Whether this is your first kamado grill or your fourth, I hope this guide inspires you to light it up, gather friends and family, try new foods and chase that wonderful, wood-fired flavor. Just like thousands of others have before us.

Fire it up!

A handwritten signature in black ink that reads "Bobby Brennan". The script is fluid and cursive, with the first letters of "Bobby" and "Brennan" being significantly larger and more stylized than the rest of the letters.

Bobby Brennan



WARNING

- This manual contains important information necessary for the proper assembly and safe use of the appliance.
- Read and follow all warnings and instructions before assembling and using the appliance.
- Keep this manual for future reference.



Failure to follow these instructions could result in fire, explosion or burn hazard which could cause property damage, personal injury or death.



CARBON MONOXIDE HAZARD

- Burning charcoal or wood chips gives off carbon monoxide, which has no odor and can cause death.
- Use only outdoors where it is well ventilated.



WARNINGS AND IMPORTANT SAFEGUARDS

READ ALL INSTRUCTIONS

- **WARNING!** This barbecue will become very hot. Do not move it during operation.
- **WARNING!** Do not use indoors!
- **WARNING!** Do not use alcohol, gasoline or other similar liquids to light or relight the barbecue.
- **WARNING!** Keep children and pets away from grill at all times. Do NOT allow children to use grill. Close supervision is necessary when children or pets are in the area where grill is being used.

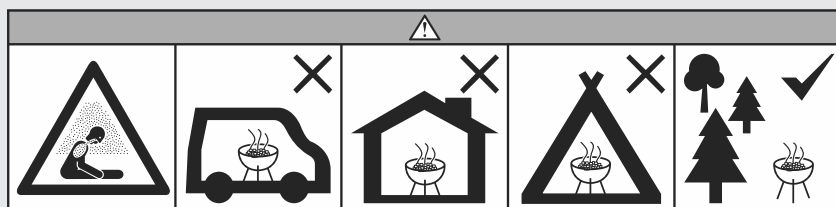

- Do not use the barbecue in a confined and/or habitable space e.g. houses, tents, caravans, motor homes, boats. Danger of carbon monoxide poisoning fatality.
- Always use grill in accordance with all applicable local, state and federal fire codes.
- Before each use check all nuts, screws and bolts to make sure they are tight and secure.
- Never operate grill under overhead construction such as roof coverings, carports, awnings or overhangs.
- Grill is for OUTDOOR USE ONLY.
- Maintain a minimum distance of 10 ft. (3m) from overhead construction, walls, rails or other structures.
- Keep a minimum 10 ft. (3m) clearance of all combustible materials such as wood, dry plants, grass, brush, paper or canvas.



WARNINGS AND IMPORTANT SAFEGUARDS

- Never use grill for anything other than its intended use. This grill is NOT for commercial use.
- Accessory attachments not supplied by Kamado Joe are NOT recommended and may cause injury.
- Use of alcohol, prescription or non-prescription drugs may impair user's ability to assemble or safely operate grill.
- Keep a fire extinguisher accessible at all times while operating grill.
- When cooking with oil or grease, have a type BC or ABC fire extinguisher readily available.
- In the event of an oil or grease fire do not attempt to extinguish with water. Immediately call the fire department. A type BC or ABC fire extinguisher may, in some circumstances, contain the fire.
- Use grill on a level, non-combustible, stable surface such as dirt, concrete, brick or rock. An asphalt surface (blacktop) may not be acceptable for this purpose.
- Grill MUST be on the ground. Do not place grill on tables or counters. Do NOT move grill across uneven surfaces.
- Do not use grill on wooden or flammable surfaces.
- Keep grill clear and free from combustible materials such as gasoline and other flammable vapors and liquids.
- Do not leave grill unattended.
- Do NOT allow anyone to conduct activities around grill during or following its use until it has cooled.
- Never use glass, plastic or ceramic cookware in grill. Never place empty cookware in grill while in use.
- Never move grill while in use. Allow grill to cool completely (below 115°F (45°C)) before moving or storing.
- Do not store grill with hot ashes or charcoal inside grill. Store only when fire is completely out and all surfaces are cold.
- Never use grill as a heater. READ CARBON MONOXIDE HAZARD.
- The grill is HOT while in use and will remain HOT for a period of time afterwards and during cooling process. Use CAUTION. Wear protective gloves/mitts.
- DO NOT bump or impact the grill to prevent personal harm, damage to grill or spillage/splashing of hot cooking liquid.



WARNINGS AND IMPORTANT SAFEGUARDS

- Be careful when removing food from grill. All surfaces are HOT and may cause burns. Use protective gloves/mitts or long, sturdy cooking tools for protection from hot surfaces or splatter from cooking liquids.
- Do not touch HOT surfaces.
- Grill is HOT during use. To avoid burns, keep face and body away from vents and when opening lid. Steam and hot air are expelled during use.
- When cooking above 350°F (180°C), carefully open the grill (or burp the grill) each time you lift the grill dome to prevent flashback – a surge of white-hot heat caused by a rush of oxygen. Partially opening the lid 2-3 inches (5-8cm) and allowing heat to escape for about 5 seconds should prevent this.
- Air dampers are HOT while the grill is in use and during cooling. Wear protective gloves when adjusting.
- Grill has an open flame. Keep hands, hair and face away from flame. Do NOT lean over grill when lighting. Loose hair and clothing may catch fire.
- DO NOT obstruct flow of combustion and ventilation.
- Do not cover cooking racks with metal foil. This will trap heat and may cause damage to the grill.
- Never leave HOT coals or ashes unattended.
- Fuel should be kept red hot for at least 30 minutes prior to use.
- Do not cook before the fuel has a coating of ash.
- Use protective gloves when handling this grill or working with fire. Use protective gloves or long, sturdy tools when adding wood or charcoal.
- Never use charcoal lighting fluid, gasoline, alcohol or other highly volatile fluids to ignite charcoal. These fluids can explode and cause injury or death.
- The maximum amount of charcoal for the Big Joe III is 10 lbs. (4.7 kg). Never overfill charcoal grate. This can cause serious injury as well as damage to the grill.
- Dispose of cold ashes by placing them in aluminum foil, soaking with water and discarding in a non-combustible container.

SAVE THESE INSTRUCTIONS

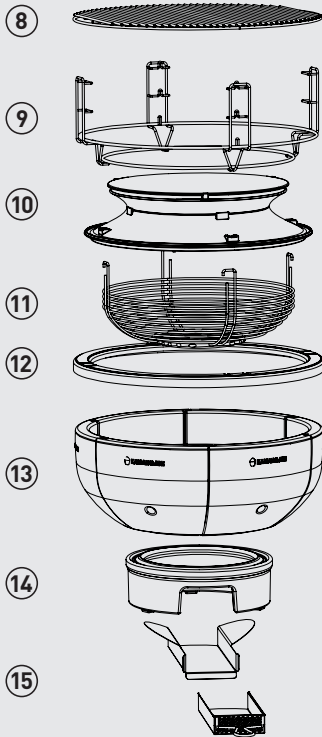
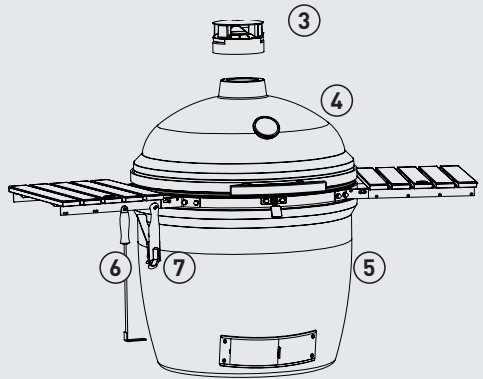
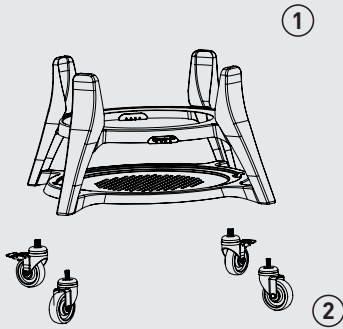

1. **BIG JOE III CART (1)** BJ-MC3
2. **LOCKING SWIVEL CASTERS (2)** BJ-CL24. **NON-LOCKING SWIVEL CASTERS (2)** BJ-CL24
3. **KONTROL TOWER TOP VENT (1)** KJ-KT
4. **GRILL DOME (1)** BJ-CD24RCI
5. **GRILL BASE (1)** BJ-CB24RCI
6. **ASH TOOL (1)** BJ-P24HB
7. **GRILL GRIPPER (1)** KJ-GG
8. **HALVED COOKING GRATES (2)** BJ-HC6
9. **DIVIDE & CONQUER FLEXIBLE COOKING SYSTEM (1)** BJ-FCR
10. **SLøROLLER HYPERBOLIC CHAMBER (1)** BJ-HBI
11. **STAINLESS STEEL CHARCOAL BASKET (1)** BJ-MCC24
12. **STAINLESS STEEL FIREBOX COVER (1)** BJ-SSFBC
13. **FIREBOX WALLS (5)** BJ-MPFBSIDE24
14. **FIREBOX BASE (1)** BJ-MPFBBASE24
15. **SLIDE-OUT ASH DRAWER (1)** BJ-RC24

Tools required for assembly: Phillips screwdriver

Grill Set-Up

UNBOXING YOUR GRILL

- 1 Cut the plastic bands and remove the top and side panels of the shipping container.
- 2 Lift off the top piece of the grill cart and remove the plastic from the top of the grill.
- 3 Open the dome of the grill and remove the components from the inside of the grill. Handle the internal ceramic parts with care.

KAMADO JOE GRILL WITH CART

- 1 Once the internal components of the grill have been removed, lift the grill out of the container and set it aside. Due to the weight of this grill, we highly recommend two people perform this task. Do NOT lift the grill by the side shelf tabs. Use the rear hinge and the front lower vent opening as lifting points.
- 2 Remove the plastic wrapping from the base of the grill cart.
- 3 Lock the casters on the bottom portion of the grill cart. Assemble the two pieces of the grill cart with the provided stainless steel screws. You will find these screws attached with tape and plastic on the bottom portion of the cart.
- 4 With the same lifting technique used previously, lift the grill into the cart. Adjust the grill in the cart so the lower grill vent is facing the front of the cart. The front side of the cart is the side with the two locking casters.

Internal Assembly

A key innovation to the internal architecture of your Kamado Joe is our AMP FireBox. Together with the Divide & Conquer® Flexible Cooking System and Slide-Out Ash Drawer, they create the perfect internal conditions needed for more functional, flavorful results. Building a better grill starts with a few easy steps and the parts below.

ASSEMBLY

- 1 Open the dome and place the Slide-Out Ash Drawer in the bottom of the grill so handle aligns with lower vent opening.
- 2 Place the base of the FireBox over the Slide-Out Ash Drawer aligning the opening of the base with the ash drawer handle.
- 3 Begin building the FireBox Walls. Place each piece on top of the FireBox Base. Note: the pieces will lean against the inner wall of the base of the grill.

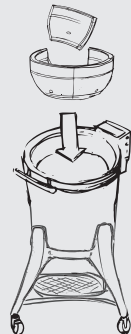

PARTS

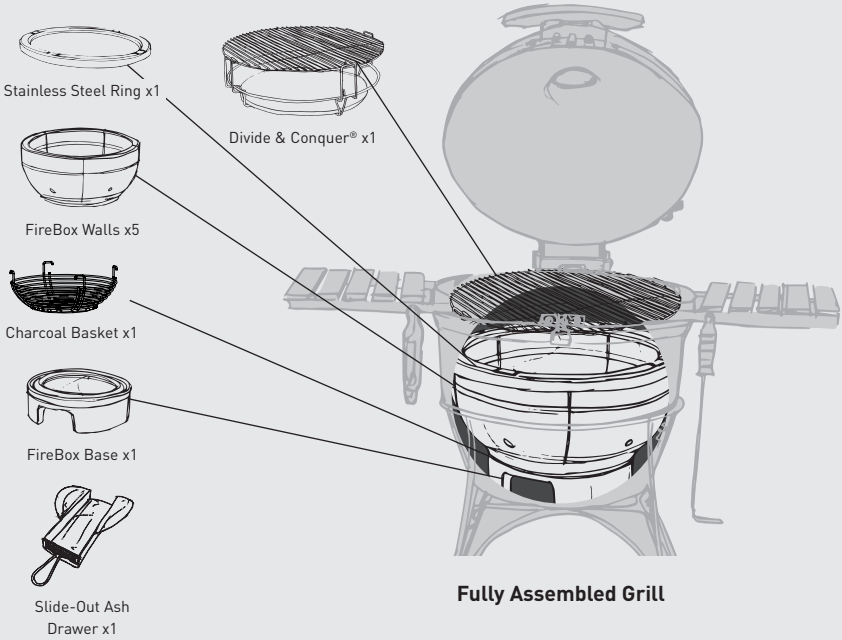

4 Using the hole in each piece, pull towards the center to fit under the outer rim of the Stainless Steel Ring. Repeat step for each piece until FireBox is secure.

5 Set the Stainless Steel Charcoal Basket on top of the base.

6 Place the Divide & Conquer® on top of the Stainless Steel Ring. Note: the flexible cooking system rack should fit on the indents of the ring.

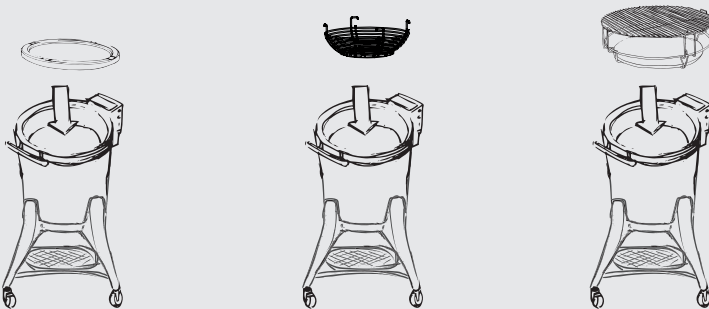

*See page 30 for SloRoller Hyperbolic Chamber installation instructions.

The Art of Kamado

FIRE TAMED THE WORLD—BECAUSE WITHOUT FIRE, THERE IS NO COOKING

Meals began and ended around a fire. Over time, cooking progressed from a simple skewer to a spit to early ovens. These earthenware cooking vessels channeled and controlled the fire's heat for better flavor. Slowly, the rudimentary cooking vessels evolved around the world, becoming the tandoor oven in India and the charcoal-fueled mushikamado in Japan.

After the Second World War, American soldiers discovered the superior, wood-fired flavor of the kamado and brought the grill home to the States. Since then, the kamado grill has been refined as a versatile ceramic cooker that continues to impress with the incredible flavor and textures it produces. From rich, smoked meat falling apart at the bone to crispy pizzas to juicy, caramelized steaks seared over a hot flame—meals prepared in the kamado taste elemental and true.

Our ancestors understood what we often forget: that time is the best ingredient. Thousands of years ago, people gathered around the kamado while their food cooked; today, despite our sprawling kitchens and double ovens and induction stoves, the kamado is still bringing people together around the fire. More than a way of cooking, kamado is a way of connecting. Connecting with the elements. With our hands, with our food. With the people we love. It's not fast food. Like any art, it takes time. And the result is a meal that rewards us with unmatched flavor—and the satisfaction of time well spent.

FUNDAMENTALS

Good kamado cooking begins with a good foundation. Learn how to master the elements and control your grill—and you'll be on your way to incredible flavor.

— PG.10

FIRE

— PG.12

SMOKE

— PG.14

DISTANCE

— PG.16

SURFACES

TECHNIQUES

Knowing these few quintessential methods will expand your grilling possibilities. They'll equip you for any recipe you want to tackle.

— PG.18

GRILLING

— PG.20

SEARING

— PG.22

BAKING

— PG.24

ROASTING

— PG.26

SMOKING

The Fundamentals of Fire

Fire is the single most important ingredient in successful kamado cooking—and it's made from just three elements: oxygen, heat and fuel. Learn how to control them, and you'll know how to control your fire.

FLAVOR COMES FROM FUEL

Only use premium hardwood lump charcoal to fuel your fire. Combustible liquids (starter fluid, etc.) will impart undesired flavors, damage your grill and create a fire hazard. Remember: flavor comes from your fuel. The taste you put in will eventually come out on your plate.

GOOD FIRE STARTS WITH GOOD AIR FLOW

Add charcoal to the firebox until the mound reaches the fire ring. Maximum charcoal amount for the Big Joe III is 10lb (4.7 kg). If you're aiming for high temperatures, you can arrange your charcoal mound for maximum air flow—large chunks on the bottom, smaller pieces to fill in. Now you're ready to light your charcoal. Fire is a living thing. It needs to breathe a little while before you begin adjusting the temperature, so leave the dome open for about 10 minutes after lighting.

CHARCOAL CAN BE RE-USED UNTIL IT'S GONE. BEFORE YOUR NEXT COOK, MAKE SURE TO STIR THE CHARCOAL TO KNOCK OFF ANY LOOSE ASH, REMOVE THE ASH FROM THE ASH DRAWER AND THEN TOP OFF THE FIREBOX WITH THE DESIRED AMOUNT OF NEW CHARCOAL. WE RECOMMEND A FULL BOX OF CHARCOAL FOR HIGH-TEMPERATURE COOKING.



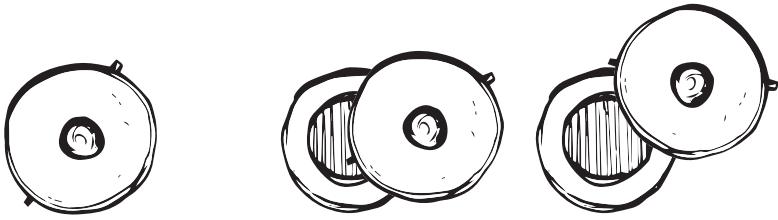

MORE AIR, MORE HEAT—LESS AIR, LESS HEAT

The Kamado Joe's top and bottom vent system is like a volume dial for your fire. Air moves in the bottom vent and out through the top. Open them to accelerate air flow and 'turn up' the temperature; close them to lower it. If you want a hot fire for searing, you'll need both vents to be mostly open. A low fire for smoking? They should be mostly closed.

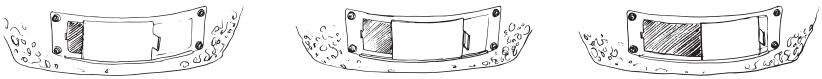

CONTROL FROM THE TOP DOWN

The Kamado Joe can achieve temperatures ranging from 225°F to 750°F (120°C to 400°C).

It's easiest to reach and maintain your target temp by setting the bottom vent and adjusting with the top vent. With the dome closed, keep the top vent all the way open until you are 50°F (10°C) away from your target temp. Then begin closing the top vent down, wait a minute or two and make necessary adjustments by closing or opening the top vent more.

GIVE THE FIRE TIME

The biggest mistake you can make is shortchanging your Kamado Joe on time after lighting the charcoal. You get beautiful results from your grill because its ceramic walls absorb, retain and distribute heat like nothing else—but it takes time for those walls to evenly absorb heat. Give your grill 20–40 minutes after lighting to stabilize its temperature before starting your cook. And while you're working to raise the grill's temperature, go slowly. Because those ceramic walls retain heat so well, it's much easier to increase the heat slightly than it is to bring the temperature down after overshooting your target.

The Fundamentals of Smoke

Smoke is the taste that can't be mimicked or faked. It transforms even the most lowly of meats, adds complexity, makes a meal worth remembering. Because the Kamado Joe is charcoal-fueled, everything you cook in it will come away subtly changed by smoke, no matter which technique you use. Smoke is the flavor we're all chasing.

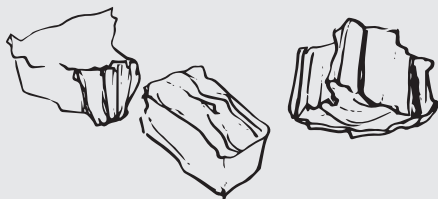

A LITTLE WOOD GOES A LONG WAY

The secret to successful smoking in your kamado is remembering that less is more. There's no need to load up your firebox with smoking wood; it only takes a few chunks to impart flavor. You don't need to see smoke coming from the grill to be confident that smoke is infusing your food. Too much smoking wood may give your food a bitter, acrid taste.

LEAVE LIQUIDS OUT

The innovative shape and air-circulating design of the kamado creates a moist cooking environment that will produce tender, flavorful meats. There's no need to add a pan of water or liquid during the smoking process as the Kamado Joe does not require extra humidity for temperature control.

SMOKING IS AN ART, NOT A SCIENCE

When it comes to smoking foods, there are no hard rules, only suggestions. Every decision you make—from the type of wood to the spice rub to the length of smoking time—is driven by your palate and preferences. Different types of wood produce different aromas and taste or flavor intensities. High-intensity woods, like hickory and mesquite, make a natural pairing for beef, while light-intensity fruitwoods bring out the sweetness of pork. Some people prefer a punch of powerful flavor and others prefer just a kiss of smoke—you will discover your own taste in time, but it's best to start with less and add more.



PREFERENCE AND EXPERIENCE SHOULD GUIDE YOU WHEN ADDING SMOKING WOOD TO YOUR FIREBOX, BUT HERE'S A QUICK RULE OF THUMB FOR STARTING OUT: 1 CHUNK FOR POULTRY AND FISH (BECAUSE THEY ABSORB SMOKE AT A HIGHER RATE THAN BEEF OR PORK); 2-4 CHUNKS FOR CUTS OF MEAT THAT ARE LARGER THAN 6 POUNDS (SUCH AS BUTTS, BRISKET, RIBS). ADD MORE TO YOUR TASTE.

The Fundamentals of Distance

FINDING THE SWEET SPOT

Perhaps your first lesson about fire, heat and distance came from the great childhood s'more. Maybe you were patient in the pursuit of the ideal golden toast and you held your marshmallow high over the fire, waiting. Maybe you craved the crispy char of a blackened outside so you zipped yours in and out of the flame. Whatever path you chose to marshmallow bliss, the lessons learned about proximity to flame apply for your kamado, too.

THERE ARE THREE WAYS TO COOK OVER A FIRE:

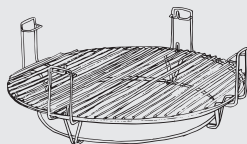

Close and quick > direct heat

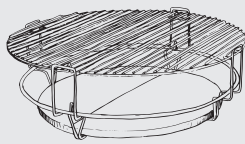

Far and slow > indirect heat

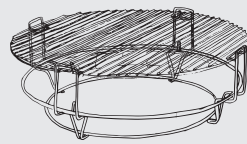

Far and quick > direct heat

Typically, when you're looking for good color and char, you'll cook your food close to direct heat. A grill rack installed in the high position over direct heat delivers incredible flavor as your food cooks. If you want an extremely hot sear for foods like burgers and steaks, you'll cook over direct coals with the grill rack in the low position. When you'd rather let a steady fire and flavorful smoke work their magic on foods like brisket, breads or ribs, you will position your food farther away to take advantage of indirect heat.

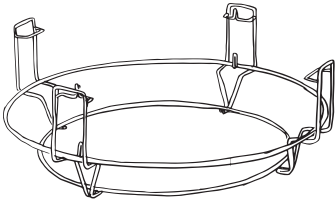

Flexible Cooking System Rack

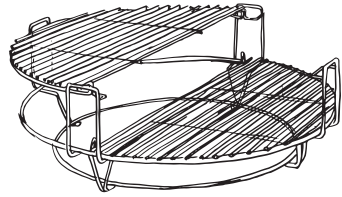

Halved Cooking Grates

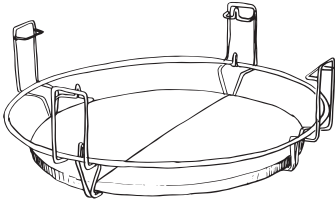

Two Halved Heat Deflectors

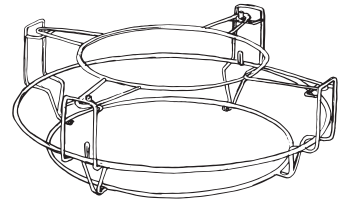

Accessory Rack

TWO WAYS AT ONCE

Sometimes you'll want to cook two different ways at the same time. That's why we created the Divide & Conquer® flexible cooking system. Its innovative design allows you to create multi-level heat zones—so you can sear a steak and slow-roast your vegetables simultaneously.

The beauty of this system rests in our signature half-moon design. First, the halved heat deflectors can either partially block heat to create two-temperature cooking zones, or completely cover the flame to produce the ideal indirect heat for baking, smoking and roasting. Using both heat deflectors effectively converts your kamado from a grill to a charcoal-fired oven—meaning that anything you cook in an indoor oven can also be cooked on your Kamado Joe. Installation is flexible, too, allowing you to move cooking grates and heat deflectors up and down for achieving different high and low temperatures.

Next, we've made our cooking surfaces half-moon shaped as well, giving you flexibility with what and when you cook. Use one surface for searing pork chops over open flame and another to roast sweet potatoes—at the same time.

The Fundamentals of Surfaces

MASTERING YOUR TOOLS

Think of Kamado Joe cooking surfaces like your kitchen's pots and pans. Or like your most essential tools. Different materials (cast iron, stainless steel, ceramic stone) hold and transfer heat in unique ways. Finding the right heat transfer—from flame to surface to food—is the key to achieving a perfect finish, no matter what you're cooking.

The beauty of cooking over flame is that it's not complicated. You're well-equipped for success with just our standard stainless steel grate. But as you explore the kamado tradition and try new recipes or new techniques, you'll find that certain surfaces make certain foods sing. They will earn a place in your kit—like every good tool does.

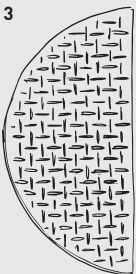
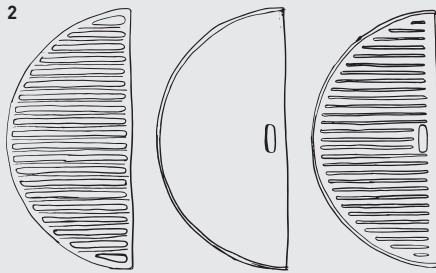
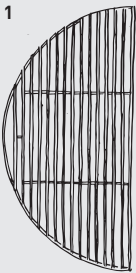

A GUIDE TO SURFACES

1 Standard Stainless Steel Grate

This highly versatile cooking grate comes standard with the Kamado Joe for a reason: it's durable, easy to clean and well-suited for cooking a wide variety of foods. Stainless steel heats up very quickly and distributes heat very evenly. Many people use this as their all-purpose cooking surface.

2 Cast Iron

Nearly indestructible, cast iron is one of the oldest cooking materials in the world. Designed to withstand high temperatures, cast iron absorbs, retains and conducts heat extremely well—making it the perfect surface for high-heat searing. Use the cast iron grate or griddle anytime you're looking for a good sear, color and caramelization.

3 Laser-Cut Stainless Steel

Designed for even heat distribution and made double thick for durability, this smooth stainless steel surface protects fragile proteins, like fish, from falling apart while cooking. Its laser-cut design is also ideal for roasting vegetables, since its small slits allow heat to pass through without risking your veggies dropping through a grate into the flame.

4 Soapstone

Thanks to its supremely even heat distribution, this thick, bacteria-and-stain-resistant slab is ideal for keeping meat and fish moist as they cook in their own juices. Its slab-style construction absorbs and radiates indirect heat, preventing flare-ups along the way.

5 Ceramic Pizza Stone

Ideal for baking and browning, the ceramic stone offers superior heat retention and distribution. The ceramic draws moisture out of dough to create that perfect, slightly crunchy crust on pizzas and breads.

The Technique of Grilling

HOW TO GRILL

Grilling is the go-to technique for quick, delicious and consistent results. Using high-quality charcoal will ensure a steady flame and unmatched flavor in everything you grill, from burgers to corn on the cob.

GRILLING CONFIGURATIONS:

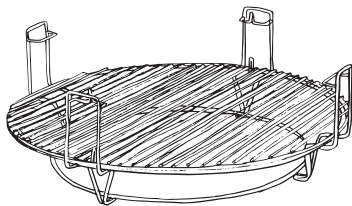

A with both half-moon grates in lower position

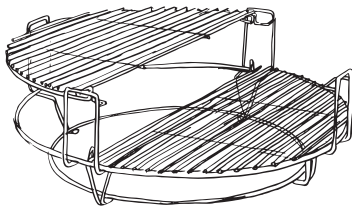

B with one half-moon grate in top position and one in lower position

- 1. Top off or fill the firebox with charcoal. Light the charcoal in 1–2 places to help your grill heat as quickly as possible.**
- 2. Install one or two half-moon cooking grates. Leave the dome open for about 10 minutes, then close.**
- 3. Open the bottom vent and top vent fully until the Kamado Joe reaches target temperature for grilling, 400–600°F (205–315°C). Then close the top vent halfway to maintain, making adjustments if necessary.**
- 4. Be sure to ‘burp’ the grill every time you open the dome to prevent dangerous flashback—a surge of white-hot heat caused by a rush of oxygen. Partially opening the dome (2–3 inches) and allowing heat to escape for about 5 seconds should prevent this.**
- 5. When the grill is hot enough, place your food on the grate and turn when necessary. Use tongs, not forks, to turn to prevent juices from escaping.**

Barbecue Cheddar Burgers

Preparation: 30–60 mins. | Cooking: 15–20 mins. | Surface: Steel or Cast Iron Grate

1 Preheat your Kamado Joe grill to 400–450°F (205–230°C). Configure the Divide & Conquer® flexible cooking system for standard grilling by placing both halves of the grill grates in the lower position of the rack.

2 Combine sauce ingredients in a small bowl and set aside.

3 In a mixing bowl, combine the ground beef with the barbecue and beer sauce and mix completely. Divide the mixture into four equal parts and press into hamburger patties. Sprinkle salt and pepper to taste on each side of the patties and set aside.

4 Drizzle onion slices with olive oil and place on the grill.

5 Place hamburgers on the grill and cook for 3–4 minutes.

6 Flip the burgers and place one of the onion slices on the top of each burger along with a slice of cheese. Continue cooking until the burgers reach your desired level of doneness.

7 Prepare hamburger buns by adding barbecue sauce to each side along with a slice of lettuce and tomato. Add your burger to the stack and enjoy!

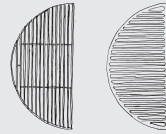

INGREDIENTS

Serves 4

- 1 ¼ pounds ground chuck (80/20)
- 1 Vidalia onion, sliced
- 4 slices sharp cheddar cheese
- 4 slices of tomato
- Lettuce
- Barbecue sauce, olive oil, salt and pepper to taste
- 4 hamburger buns

Sauce:

- ¼ cup barbecue sauce
- ¼ cup beer

The Technique of Searing

HOW TO SEAR

Searing delivers the incredible color and flavor you think of when you picture a juicy steak or flame-finished scallops. Timing is key to mastering this high-heat technique. You'll need to give the Kamado Joe enough time to reach the right temperature (500–750°F/260–400°C) for searing, so be sure to light your grill well in advance. With the grill rolling at such high temperatures, searing won't take long. The goal is to seal in flavor and create a rich, brown char without burning the food.

SEARING CONFIGURATIONS:

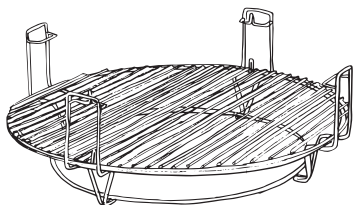

A with both half-moon grates in lower position

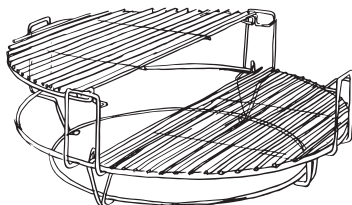

B with one half-moon grate in top position and one in lower position

- 1. One hour before you want to sear, start with a full firebox of fresh charcoal. Light the charcoal in 1–2 places to help your grill heat as quickly as possible. Install one or two half-moon grates in the lower position, closest to the coals. Leave the dome open for about 10 minutes and close once embers have begun to build.**
- 2. Open the bottom vent and top vent fully until the grill reaches 500°F or above. Then close the top vent slightly to maintain.**
- 3. Be sure to ‘burp’ the grill every time you open the dome to prevent dangerous flashback—a surge of white-hot heat caused by a rush of oxygen. Opening the dome 2–3 inches and allowing heat to escape for about 5 seconds should prevent this.**
- 4. When the grill is hot enough, place food on the grate over the flame. Use tongs, not a fork, to turn to prevent juices from escaping.**

Dry-Rubbed New York Strip Steaks

Preparation: 30–60 mins. | Cooking: 10 mins. | Surface: Steel/Cast Iron Grate or Cast Iron Griddle

1 Preheat your Kamado Joe grill with the Divide & Conquer® flexible cooking system set up for two-zone direct and indirect cooking. Place the grill or griddle on the lower rack directly above the hot coals. Place a heat deflector on the opposite low side with a grill grate in the elevated position above the heat deflector. Allow the grill to reach 500°F (260°C).

2 While the grill is preheating, combine the dry rub ingredients, mix well and set aside.

3 Melt the clarified butter or unsalted butter. Dredge cold steaks in the melted butter, coating both sides of the meat. Sprinkle the dry rub liberally on both sides of each steak. Allow the steaks to sit on the counter while the grill continues to preheat.

4 Once the grill is preheated, place steaks on the direct heat side grate or griddle for 2 minutes to achieve a nice sear. Flip the steaks and sear for another 2 minutes.

5 Move the steaks to the indirect side of the grill and continue to cook until you reach your desired level of doneness.

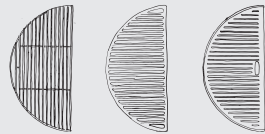

INGREDIENTS

Serves 4

4 New York strip steaks
1 to 2 inches thick
4 tablespoons melted clarified butter (or regular unsalted butter)

Dry Rub:

1 tablespoon sea salt
1 teaspoon cracked black pepper
½ teaspoon paprika
½ teaspoon granulated garlic
½ teaspoon finely ground coffee
¼ teaspoon ground cayenne pepper

The Technique of Baking

HOW TO BAKE

More than a grill, the Kamado Joe can become a charcoal-fired oven with just one simple configuration. Its ceramic walls retain heat and its circular shape promotes superior air circulation, creating ideal conditions for baking. You can bake anything you'd cook in an indoor oven, from wood-fired pizzas to rustic berry cobblers to fresh, crusty bread. Note: to bake pizza, you'll need to raise the temperature beyond typical baking temperatures (300–450°F/150–230°C) to 500°F (260°C) or higher.

BAKING CONFIGURATIONS:

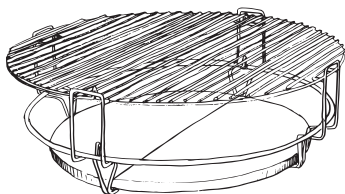

A with both half-moon grates and both heat deflectors



B with pizza stone and both heat deflectors

- 1. Top off or fill the firebox with charcoal. Light the charcoal. Install the heat deflector plates; then place the pizza stone or cooking grate on top. Leave the dome open for about 10 minutes, then close.**
- 2. Open the bottom vent and top vent halfway until the Kamado Joe approaches 300–450°F (150–230°C). Then begin closing the vents as needed to stabilize the kamado at your target temperature. If you're making pizza, increase the heat to 500°F (260°C) or higher.**
- 3. Be sure to 'burp' the grill every time you open the dome to prevent dangerous flashback. Opening the dome 2–3 inches and allowing heat to escape for about 5 seconds should prevent this.**
- 4. When the grill is hot enough, you're ready to bake. Use the top daisy wheel to fine-tune any temperature adjustments.**

Pizza

Preparation: 90–120 mins. | Cooking: 10 mins. | Surface: Ceramic Pizza Stone

- 1 Mix water, olive oil, sugar and yeast in the mixing bowl of a stand mixer. Let sit for 10–15 minutes until bubbling occurs.
- 2 Stir in flour and salt and mix with the dough hook attachment for about 5–6 minutes. Transfer the dough ball into an oiled bowl and roll the dough ball to coat. Cover the bowl with plastic wrap and let sit in a warm place for 60–90 minutes until the dough has doubled in size.
- 3 Meanwhile, light and preheat your Kamado Joe grill to 500°F (260°C) with the heat deflectors and pizza stone in the highest position on the Divide & Conquer® flexible cooking system rack.
- 4 After the dough has risen, divide it into two equal parts. Roll each ball into a large, thin circle on a well-floured surface. Sprinkle cornmeal on the pizza peel and transfer the dough to the peel. Poke the dough all over with a fork to prevent bubbling. Brush dough with olive oil before evenly spreading a thin layer of pizza sauce. Add any additional pizza toppings you like.
- 5 Transfer pizza to the pizza stone in your Kamado Joe grill. Close the dome and cook for 7–10 minutes. Be sure to burp the grill before opening the dome fully at these temperatures. Remove the pizza with a pizza peel and let cool before slicing.



INGREDIENTS

Serves 4–6 (2 pizzas)

Pizza Dough:

- 1 cup lukewarm water
- ¼ cup extra virgin olive oil
- 1 teaspoon sugar
- 1 packet instant dry yeast
- 3 cups all-purpose flour
- 1 teaspoon salt

Additional Ingredients:

- Cornmeal for dusting the pizza peel
- Extra virgin olive oil for basting the top of the pizza crust
- Pizza sauce
- Your choice of pizza toppings

The Technique of Roasting

HOW TO ROAST

Juicy and tender on the inside, crisp and flavorful on the outside—this is the work of roasting. This technique is delicious for larger cuts of meat, like whole chicken or pork loin, or for vegetables. The mid-range temperature (300–450°F/150–230°C) harnesses the power of slow, indirect heat to infuse food with wood-fired flavor and tenderness, while delivering enough heat to create a crisp crust or finish. And if you want to experiment with brines or spice rubs, roasting is a great way to show them off.

ROASTING CONFIGURATIONS:

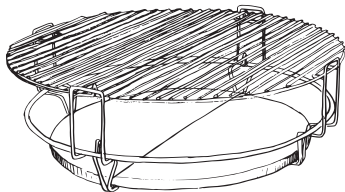

A without drip pan

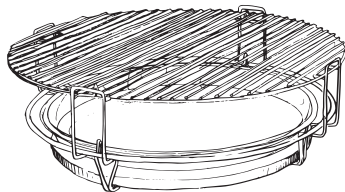

B with drip pan

-
- 1. Top off or fill the firebox with charcoal. Light the charcoal.**
 - 2. Install the heat deflector plates; then place the cooking grate on top. Leave the dome open for about 10 minutes, then close.**
 - 3. Open the bottom vent and top vent halfway until the Kamado Joe approaches the target temperature for roasting, 300–450°F (150–230°C). Then begin closing the vents as needed to stabilize the Kamado Joe at your target temperature.**
 - 4. When the grill is hot enough, you're ready to roast.**

Roast Chicken

Preparation: 30–60 mins.

Cooking: 60–90 mins.

Surface: Steel or Cast Iron Grate

- 1 Rub the entire chicken with the olive oil.
- 2 Combine the salt, pepper, thyme and cumin and coat the outside of the chicken liberally.
- 3 Place the chicken on the grill, breast side down, and cook for 1 to 1 ½ hours until the temperature in the thick part of the breast reaches 160°F (70°C).
- 4 Remove from the grill, loosely tent with aluminum foil and let rest for 15 minutes before serving, or until the internal temperature reaches 165°F (75°C).

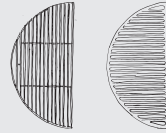

INGREDIENTS

- 1 whole chicken, 4 to 6 lbs., rinsed, patted dry with all items removed from inside
- ¼ cup extra virgin olive oil
- 1 tablespoon salt
- 1 teaspoon black pepper
- 1 teaspoon dried thyme
- 1 teaspoon cumin

The Technique of Smoking

HOW TO SMOKE

Smoking is low and slow cooking at its finest. The unique shape and design of the kamado keeps meat moist as the heat gently breaks down collagen—all the while infusing it with a deep, smoky flavor. Of course, meat isn't the only food you can smoke. From fish to nuts to vegetables, a range of foods benefit from the complex flavor of wood smoke.

SMOKING CONFIGURATIONS:

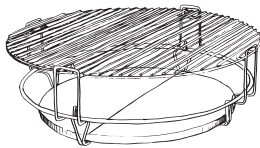

A grates on top level

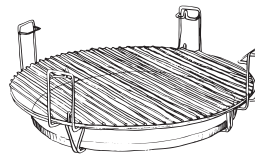

B grates on bottom level

SLOROLLER INSTALLATION INSTRUCTIONS:

1. Remove the Divide and Conquer Flexible Cooking System.
2. Fill firebox with fresh charcoal and place in a few chunks of smoking wood (1-6, depending on your cook).
3. Place the SloRoller base ring directly on top of the firebox.
4. Ensure the heat deflectors are removed from the D&C system then place the system on top of the SloRoller base.
5. Light your fire.
6. Place the middle section of the SloRoller on top of base, followed by top plate.
7. Open the bottom vent about 2 inches, fully close the top vent and open the daisy wheel until the Kamado Joe reaches target temperature for smoking, 225-275F (105-135°C). Adjust by opening or closing the daisy wheel, and if the temperature still remains too high, close the bottom draft vent another ¼ inch to ½ inch.
8. Wait until the thick, white smoke dissipates. When the Kamado Joe has reached the correct temperature, place food on the grate and close the dome.
9. When not in use, the SloRoller can be stored on the bottom shelf of the grill cart.

Smoked Pulled Pork Barbecue

Preparation: 30–60 mins. | Cooking: 8–10 hrs. | Surface: Steel or Cast Iron Grate

- 1 Preheat your Kamado Joe grill to 250°F (120°C) with 2 or 3 chunks of hickory smoking wood added to the firebox. Configure the Divide & Conquer® flexible cooking system for smoking by placing the heat deflectors in the lowest position and the grill grates in the highest position.
- 2 Rinse and pat the Boston butt dry. Combine the dry rub ingredients and apply liberally to all sides of the meat. Allow to sit on the counter at room temperature while the grill preheats.
- 3 Place the meat in the center of the grill. Allow to cook until the internal temperature in the center of the meat reaches 200°F (95°C). On average, this will take 1.5 hours per pound. When the internal temperature reaches 200°F (95°C), remove from the grill. Allow the meat to sit on the counter uncovered for 10–15 minutes. Double wrap the meat in aluminum foil, place it in an empty cooler, and allow it to rest for a minimum of 1 hour and up to 5 hours.
- 4 Remove the meat from the foil. Pull the bone out of the meat. Shred the meat with forks and serve!

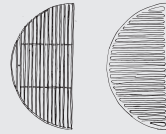

INGREDIENTS

1 6–7-pound bone-in Boston butt

Dry Rub:

¼ cup salt

¼ cup sugar

1 tablespoon paprika

1 tablespoon black pepper

2 teaspoons onion powder

1 teaspoon garlic powder

Big Joe Air Lift Hinge Adjustments

The Air Lift Hinge on your Kamado Joe Big Joe is already pre-adjusted for ideal balance and stability. Follow these instructions for any additional adjustment to suit your personal preferences.

Caution: Air Lift Hinge under high tension.

- 1 Open the dome of your Kamado Joe Big Joe grill.
- 2 With the dome open, place the 10mm wrench on the flats of the screw (see Inset 1). If your unit does not have the flats, place a 7mm socket wrench on the bottom end of the screw instead of using the 10mm wrench (see Inset 2).
- 3 Place the 19mm wrench on the nut on top of the spring retainer (see Inset 1).
- 4 To make the dome easier to raise, hold the 10mm (or 7mm) wrench stationary and rotate the 19mm wrench clockwise as shown. Remove the wrenches and check the dome action for every full rotation of the nut. If you want the dome to feel heavier, rotate the nut counter-clockwise. Remove the wrenches and check the dome action for every full rotation of the nut. Do not adjust the nut so that it contacts the connector (see Inset 1).

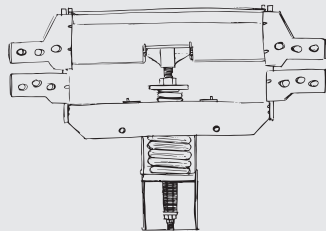
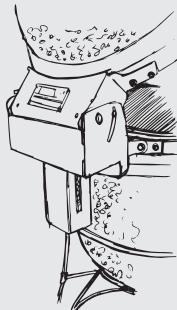

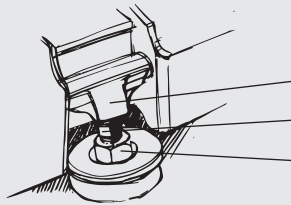
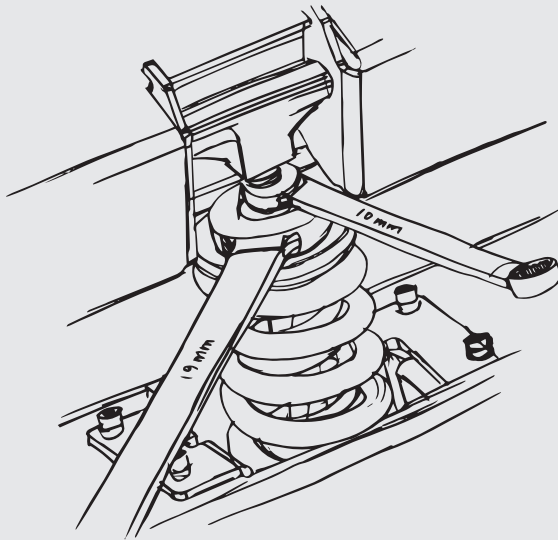
**Inset 1**

Connector

Flats on screw

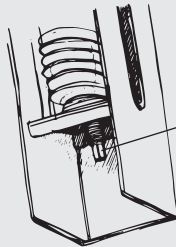
Adjustment nut on
spring retainer**Inset 2**Hex end for 7mm
socket wrench

TOOLS REQUIRED: 10MM OPEN END WRENCH OR 7MM (OR 9/32 INCH) SOCKET WRENCH, DEPENDING ON THE MODEL. 19MM OPEN END WRENCH (OR 3/4 INCH OPEN END WRENCH)

Latch Adjustments

The latch on your Kamado Joe Big Joe is already preset for an ultra-tight seal. Use these instructions if any adjustments should be needed.

CLASSIC & BIG JOE

To tighten and loosen the latch, use a small allen wrench to adjust the set screw (right to tighten, left to loosen).

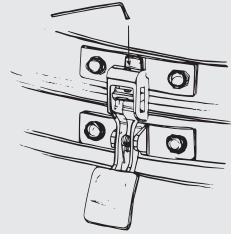
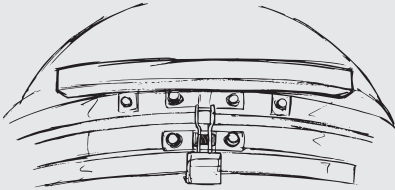

Safety Information

CAUTION

Hinge and band is under high tension, failure to follow instruction steps in order may result in severe injury.

HINGE

Do not attempt to disassemble the hinge or loosen bands from your grill without the hinge disengagement tool kit.

NOTE: Hinge disengagement tool kit (spacer, washer, and hex nut are included). Store these parts in case the hinge needs to be removed later. The hinge cannot be removed safely without these parts.

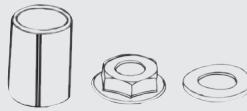

If attempting to use the hinge as a lifting point, grasp the hinge near the mounting point and/or bands, not the bottom.

Only minor adjustments to the weight of the dome should be made per the instructions on page 32–33.

GASKET

Self-cleaning through natural heat cycle recommended.

Do not use chemical based cleaners on the gasket.

If absolutely necessary, gently wipe off any spills or moisture.

Do not scrub or abrade the gasket if cleaning. Excessive rubbing can cause wear.

Cleaning & Care

Your Kamado Joe grill is made of quality materials, so general care and maintenance is minimal. The best way to protect your Kamado Joe from the elements is with a grill cover.

SELF-CLEANING

- 1** Add charcoal and light it.
- 2** Install the Divide & Conquer® flexible cooking system rack with the accessory rack in the top position and both heat deflectors on the accessory rack.
- 3** Open the top and bottom air vents fully and let the temperature inside the grill rise to 600°F (315°C) with the dome closed.
- 4** Hold the temperature at around 600°F (315°C) for 15-20 minutes.
- 5** Close the bottom vent fully and wait another 15-20 minutes to close the top vent.

This process will burn off any unwanted residue from the inside of your grill. Before cooking again, brush the cooking grate with a standard grill brush. Use a soft bristle brush on the ceramics to remove any residue. Your heat deflector plates should also be free of burned on residue after this process. Brush them down with a soft bristle brush after cleaning. When your heat deflectors get dirty during normal use, flip them over with the dirty side down for the next cook and the heat from the fire will self-clean that side of the deflector plate.

Once or twice a year, you should do a more thorough cleaning of the inside of the grill. Remove the internal components and remove any residual ash or debris that has collected between the grill body and the internal components. Use a plastic bristle brush to clean the inside ceramic surface and scoop or vacuum debris from the bottom of the grill before replacing the internal components.

Built to Last a Lifetime

Limited Lifetime Warranty on Ceramic Parts

Kamado Joe warrants that all ceramic parts used in this Kamado Joe grill are free of defects in material and workmanship for as long as the original purchaser owns the grill.

5-Year Warranty on Metal Parts

Kamado Joe warrants that all metal and cast iron parts used in this Kamado Joe grill are free of defects in material and workmanship for a period of five years.

3-Year Warranty on Heat Deflector and Pizza Stone

Kamado Joe warrants that the heat deflector frame and ceramic plate(s) and the pizza stone used for the Kamado Joe grill are free of defects in material and workmanship for a period of three years.

1-Year Warranty on Thermometer and Gaskets

Kamado Joe warrants that the thermometer and gaskets used in this Kamado Joe grill are free of defects in material and workmanship for a period of one year.

When Does the Warranty Coverage Begin?

Warranty coverage commences on the original date of purchase and covers only the original purchaser. For the warranty to apply, you must register your grill. If a defect in material or workmanship is discovered during the applicable warranty period under normal use and maintenance, Kamado Joe will, at our sole option, replace or repair the defective component at no cost to you for the component itself. This warranty does not apply to labor, or any other cost associated with the service, repair or operation of the grill. Kamado Joe will pay all shipping charges on warranty parts.

What is Not Covered?

This warranty does not apply to damage caused by abuse or use of the product for purposes other than that for which it is designed, damage caused by lack of proper use, assembly, maintenance or installation, damages caused by accidents or natural disasters, damage caused by unauthorized attachments or modifications, or damage during transport. This warranty does not cover damage from normal wear and tear from use of the product (for example, scratches, dents, dings and chipping) or changes in the appearance of the grill that do not affect its performance.

This limited warranty is exclusive and in lieu of any other warranty, written or oral, express or implied, including but not limited to the warranty of merchantability or fitness for a particular purpose. The duration of any implied warranties, including any implied warranty of merchantability or fitness for a particular purpose is expressly limited to the duration of the warranty period for the applicable component. *Some states do not allow limitations on how long an implied warranty lasts, so the above limitation may not apply to you.

The purchaser's exclusive remedy for breach of this limited warranty or any implied warranty shall be limited as specified herein to replacement. In no case shall Kamado Joe be liable for any special, incidental or consequential damages. *Some states do not allow the exclusion or limitation of special, incidental or consequential damages, so the above limitation or exclusion may not apply to you.

What Will Void the Warranty?

Purchasing any Kamado Joe product through an unauthorized dealer voids the warranty. An unauthorized dealer is defined as, but not limited to discount clubs, big box stores or any retailer who has not been expressly granted permission by Kamado Joe to sell Kamado Joe products.

Please visit kamadojoe.com for more warranty information and service.

Quick Start Guide

STARTING IT UP

- 1 Add charcoal to firebox and light using one or two fire starters.
- 2 Leave dome open for 10 minutes with the bottom vent fully open.
- 3 Close the dome.
- 4 Begin closing the top vent and bottom vent when the dome temperature is within 50°F (10°C) of your target.

MAINTAINING TEMPERATURE

To lower the temperature, decrease the airflow through the grill by closing the vents. Conversely, raise the temperature by opening the vents. Adjustments to the vents are not immediate—allow 10–15 minutes for a vent change to take effect. Because your ceramic Kamado Joe retains heat so well, it can take some time to fully heat. Give your grill 20–40 minutes to an hour to stabilize the temp before you start cooking.

COOLING IT DOWN

- 1 When finished cooking, close the bottom vent completely.
- 2 Once the temperature falls below 400°F (205°C), close the top vent almost completely, but leave a small crack.
- 3 Do not cover the grill until the dome is cool to the touch.

TO LOWER THE TEMPERATURE, CLOSE THE VENTS.

TO RAISE THE TEMPERATURE, OPEN THE VENTS.

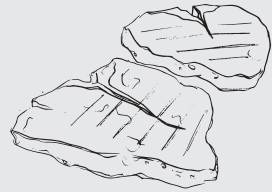

QUICK TEMPERATURE GUIDE

Approximate temperatures for cooking techniques.

GRILLING	400–600° F (205–315°C)
SEARING	500–750° F (260–400°C)
BAKING	300–750° F (150–400°C)
ROASTING	300–450° F (150–230°C)
SMOKING	225–275° F (105–135°C)

CAUTION

BURP

When cooking above 350°F (175°C), carefully open the grill (or burp the grill) each time you lift the grill dome to prevent flashback.

LIQUIDS

Do not spill liquids inside or on the grill while it is hot.

SIDE SHELVES

Do not set hot items on the side shelves.

SPARKS

Be aware of sparks and embers when using the grill on a wooden deck.

DURING OPERATION

Do not leave your grill unattended with the grill dome open.

Fire it up. Slow it down.

Thank you for choosing Kamado Joe! We are thrilled to welcome you to our ever-growing community of kamado cooks. We are confident that we have crafted the finest kamado-style cooker in the world, and we want to make sure you feel the same way. Don't hesitate to reach out to our team with questions, concerns or comments—we're always here to help.

YOU CAN REACH US A FEW WAYS:

ONLINE, AT KAMADOJOE.COM

BY PHONE:

U.S. (877) 215-6299

UK 44 20 8036 3201

EU 0031 4 7799920

BY EMAIL:

U.S. CONTACT@KAMADOJOE.COM

UK SERVICE.UK@KAMADOJOE.COM

EU SERVICE.EUROPE@KAMADOJOE.COM

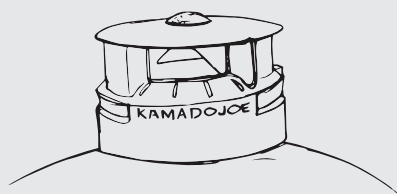

For so many of us, kamado cooking has become a passion. It's more than a way to cook—it's a way to spend time with those we love, to explore new flavors and to connect with people all over the world. The possibilities for exploring and experimenting—techniques, recipes, lessons—are almost infinite. We hope you enjoy the journey!

GATHER 'ROUND

This Owner's Manual will equip you with the foundational knowledge you need for great cooks, but we invite you to join us and other kamado fans online and on social media for endless recipes, tips, techniques, ideas and, yes, showing-off.

If you want to learn the basics or study up on your technique, our Kamado Joe YouTube channel is the best place to start. If you want to debate the finer points of smoking woods, you'll certainly find kindred spirits on our forums. And if you just want enjoy one everlasting kamado cookout, check out our social channels and be sure to tag your own posts with **#kamadojoe**.

We can't wait to see what you're cooking! Have fun and fire it up.

FIRE IT UP.

SLOW IT DOWN.

KAMADOJOE.COM

U.S. | CONTACT@KAMADOJOE.COM | (877) 215-6299

UK | SERVICE.UK@KAMADOJOE.COM | 44 20 8049 7450

**EU | SERVICE.EUROPE@KAMADOJOE.COM | +31 20 299 7500
+49 251 4474509**