

This Owner's Manual is provided and hosted by [Appliance Factory Parts](#).



COYOTE OUTDOOR LIVING C1P28 Owner's Manual

[Shop genuine replacement parts for COYOTE
OUTDOOR LIVING C1P28](#)



[Find Your COYOTE OUTDOOR LIVING Grill Parts - Select From 41 Models](#)

----- Manual continues below -----

Coyote Stainless Steel Pellet Grill Use & Care Manual

For use with Natural Wood Pellets



C1P28



C1P36



C1P28-FS



C1P36-FS



Conforms to ANSI STD Z21.58-2015
Certified to CSA STD 1.6-2015
Outdoor Cooking Appliance

FOR OUTDOOR USE ONLY

PUT SERIES NO. LABEL HERE

IMPORTANT: Read all instructions and warnings before using this product! Use of this product, as with any similar outdoor grill, will involve risks from high temperatures and from exposure to smoke and fumes. Please exercise caution and common sense.

To Installer or Person Assembling Grill: Leave this manual with grill for future reference.

To Consumer: Keep this manual for future reference as it contains important Warnings and Instructions.

COYOTE OUTDOOR LIVING, INC.

Welcome & Congratulations

Congratulations on your purchase of a new grill! We are very proud of our product and we are completely committed to providing you with the best service possible. Your satisfaction is our #1 priority.

Please read this manual carefully to understand all the instructions about how to install, operate and maintain your grill for your safety and for optimum performance and longevity.

We know you'll enjoy your new grill and thank you for choosing our product. We hope you consider us for future purchases.

Read and save the instructions



Obey all Warnings and Instructions.

This Manual provides specific operating instructions for your model. Use your grill only as instructed in this manual. These instructions are not meant to cover every possible condition and situation that may occur. Common sense and caution must be practiced when installing, operating and maintaining any appliance. If you lose this Manual, a replacement copy can be downloaded from our website at www.coyoteoutdoor.com or call Customer Service at 855-520-1559.



Table of Contents & Critical Safety Warnings

Safety Instructions.....	3
Limited Warranty.....	5
Grill Models.....	7
Locating the Grill.....	8
Electrical Requirements	11
How to Store Pellet Fuel	12
Operation of your Grill.....	13
Using the Digital Display.....	18
Care & Maintenance.....	25
Parts Listings.....	29
Wiring Diagram.....	31



Safety Symbols

 **DANGER** 



DANGER indicates an imminently hazardous situation which, if not avoided, will result in death or serious injury.

 **CAUTION** 

CAUTION indicates a potentially hazardous situation which, if not avoided, may result in minor or moderate personal injury, or property damage.



 **WARNING** 

WARNING indicates a potentially hazardous situation which, if not avoided, could result in death or serious injury.

 **WARNING** 

WARNING:

1. **DO NOT** store or use gasoline or other flammable liquids or vapors in the vicinity of this or any other appliance.

 **WARNING** 

FOR OUTDOOR USE ONLY:

NEVER operate grill in enclosed areas, as this could lead to carbon monoxide buildup which could result in injury or death. **DO NOT** use your grill in garages, breezeways, sheds or any enclosed area. **NOT FOR USE BY CHILDREN.** If these instructions are ignored, a hazardous fire or explosion could result in physical injury, death or property damage!

Important Warnings and Safety Instructions



Improper installation, adjustment, alteration, service, maintenance or use can cause injury or property damage. Read the installation, operating and maintenance instructions thoroughly before installation or servicing of this equipment.

Warning: DO NOT touch any part of the pellet grill while the smoker is HOT. Serious bodily injury could result.

General Safety Instructions



1. **For Outdoor Use Only.**
2. Coyote grills are only intended for residential use and are not intended for commercial use, where anyone other than the original purchaser (homeowner) would be using and maintaining the grill.
3. **NEVER** use indoors or in any type of enclosed area, such as a garage, shed or breezeway. Keep clear of trees and shrubs. The grills are not intended for installation in or on recreational vehicles, portable trailers, boats or any other moving installation.
4. To reduce the risk of serious or fatal injury from breathing toxic fumes and from explosion and fire as a result of burning pellets, use only outdoors in an open area with good ventilation. **NEVER** obstruct the flow of combustion and ventilation air.
5. **Fire Hazard:** The area surrounding your new grill should be kept clean and free from flammable liquids and other combustible materials such as mops, rags or brooms, as well as solvents, cleaning fluids, lighter fluid and gasoline.
6. **NEVER** use the grill in windy conditions. If located in a consistently windy area (oceanfront, mountaintop, etc.), a wind break will be required. Always adhere to the specified clearances listed in this Manual.
7. **NEVER** leave the grill unattended while cooking.
8. Do not use lighter fluid in a pellet grill.
9. **NEVER** allow children to use or play near the grill. Keep children and pets away from a hot grill at all times.
10. Installation and any repairs or replacement of parts should be performed by a qualified service technician. If you are not qualified to install, repair, or replace parts of your grill, please retain a qualified professional contractor or technician to do so.
11. **Burn Hazard:** **NEVER** lean over an open grill. Do not place clothing or other flammable material on or near the grill. Do not wear loose-fitting clothes or long sleeves while using the grill as some fabrics can be highly flammable and, if ignited, may result in personal injury or death.
12. **Burn Hazard:** When using the grill, do not touch the grill rack, burner grate, or immediate surroundings as these areas become extremely hot and can cause burns. Always use a covered/gloved hand when opening the grill hood and only do so slowly to allow heat and steam to escape.
13. **ALWAYS:** have an ABC fire extinguisher accessible.
14. **NEVER** attempt to extinguish a grease fire with water or other liquids as this may cause a flashback that could result in personal injury or death.
15. **NEVER** use aluminum foil to line the grill racks or the drip trays, this can alter airflow for proper combustion and also build up heat in the control area causing the display to malfunction.
16. **NEVER** allow grease or other hot material to drip from the grill onto the electrical supply cord. If that occurs, unplug the power supply immediately. After the grill has cooled, determine the cause of the

- dripping and correct it. If damage to the power supply is discovered, call a qualified technician for service.
17. **NEVER** heat any unopened glass or metal container of food on the grill. Pressure may build up and cause the container to burst, possibly resulting in death, serious personal injury, or property damage.
 18. **ALWAYS:** Keep any electrical supply cords away from water or heated surfaces. Electrical cords should be placed away from walkways to avoid tripping hazard.
 19. **ALWAYS:** Keep electrical supply cords as short as possible.
 20. **NEVER** move the grill when hot.
 21. **NEVER** use grill while under the influence of drugs or alcohol.
 22. **Fire Hazard:** NEVER grill without the drip trays in place; hot grease could leak downward and produce a fire or an explosion. Drip tray should be pushed all the way to the rack located just under the grill.
 23. **Fire Hazard:** Grease is extremely flammable. Let hot grease cool down before attempting to handle or dispose of it. After use and cool-down, the drip trays should be cleaned on a regular basis and kept free of grease.
 24. **ALWAYS:** Turn off power off when your grill is not in use.
 25. **ALWAYS:** Unplug the grill when not in use.
 26. **ALWAYS:** Use only a Ground Fault Interrupter (GFI) protected circuit with this outdoor cooking appliance.



DO NOT RELY JUST ON THIS SAFETY SECTION. USE CAUTION AND COMMON SENSE AT ALL TIMES.

PLEASE READ THE REST OF THIS MANUAL CAREFULLY FOR OTHER IMPORTANT SAFETY WARNINGS.

CALIFORNIA PROPOSITION 65 - WARNING: This product can expose you to Carbon Monoxide, which is on the list of substances known by the state of California to cause cancer, birth defects or reproductive harm. For more information go to: www.p65warnings.ca.gov. California law requires businesses to warn customers of potential exposure to such substances. To minimize exposure to these substances, always operate this unit according to the Use and Care Manual, ensuring you provide good ventilation when cooking with gas.

Limited Warranty

TO THE MAXIMUM EXTENT PERMITTED BY LAW, THIS LIMITED WARRANTY AND THE REMEDIES SET FORTH BELOW ARE EXCLUSIVE AND IN LIEU OF ALL OTHER WARRANTIES, REMEDIES AND CONDITIONS, WHETHER ORAL OR WRITTEN, EXPRESS OR IMPLIED. TO THE MAXIMUM EXTENT PERMITTED BY LAW, COYOTE OUTDOOR LIVING, INC. ALSO SPECIFICALLY DISCLAIMS ANY AND ALL IMPLIED WARRANTIES, INCLUDING, WITHOUT LIMITATION, WARRANTIES OF MERCHANTABILITY AND FITNESS FOR A PARTICULAR PURPOSE.

Coyote Outdoor Living, Inc. issues this limited warranty to the original purchaser at the original site of delivery with proof of purchase and specifically warrants that the Coyote Outdoor Pellet grill when subject to normal residential use, will be free from defects in workmanship and materials for the periods specified below. This limited warranty is not transferable and specifically excludes any grill used in a commercial setting, where anyone other than the original purchaser (homeowner) would be using and maintaining the grill. This limited warranty specifically excludes all issues that may arise from surface corrosion, scratches, and discoloration during regular use. This limited warranty does **NOT COVER LABOR OR LABOR RELATED CHARGES** and there will be shipping and handling charges for the delivery of part(s).

<u>COMPONENT</u>	<u>WARRANTY PERIOD</u>
Cooking Grids (no rust or burn through)	3 years (limited)
Heat Shield (no rust or burn through).....	3 years (limited)
Electric/Plastic Components	3 years (limited)
Ignition systems	3 years (limited)
Stainless steel Interior frame/housing	5 years (limited)
Stainless steel Exterior frame/housing	Limited Lifetime

Coyote Outdoor Living, Inc.'s obligation under this limited warranty is limited solely to repair or replacement, at our option, of the pertinent component during the warranty period, and the extent of any liability of Coyote Outdoor Living, Inc. under this warranty is limited to repair or replacement. This limited warranty does not cover normal wear of parts or damage resulting from any of the following: negligent use or misuse of the product, use of an improper fuel/gas supply, use contrary to operating instructions, or alteration by any person other than a factory service center. The above warranty periods are not extended by any repair or replacement.

WARRANTY CLAIM PROCEDURE: If you require service or parts for your Coyote Grill, please contact our Warranty Service Center for factory direct assistance. Our hours of operation are 8 am to 4:30 pm CST. The phone number is 855.520.1559 and the email address is support@coyoteoutdoor.com you may also fill out warranty claims online at www.coyoteoutdoor.com. Please have your model number, serial number and proof of purchase available for any warranty claim.

Coyote Outdoor Living, Inc. may require the return of defective parts for examination before issuing replacement parts. If you are required to return defective parts, shipping charges must be prepaid by the customer. Upon examination and to Coyote Outdoors determination, if the original part is proven

defective, Coyote Outdoor may approve your claim and elect to replace such parts without charge. In every instance, the customer is responsible for shipping and handling of replacement parts. Component repair or replacement is the exclusive remedy under this limited warranty and Coyote Outdoor shall not be liable for any incidental or consequential damages.

This limited warranty does not cover any failures or operating difficulties due to accidents, abuse, misuse, alteration, misapplication, vandalism, improper installation, maintenance or service, or damages caused by flashback fire or grease fire. This limited warranty does not cover scratches, dents, corrosion or discoloration caused by weather, heat, abrasive and chemical cleaners, pool or spa chemicals, and/or any tools used in the assembly or installation of this unit. This limited warranty does not cover paint loss, surface rust, corrosion or stainless steel discoloration which is considered normal wear and tear. This limited warranty does not cover the cost of any inconvenience, personal injury, or property damage due to improper use or product failure. Deterioration or damage due to severe weather conditions such as hail, hurricanes, earthquakes, tsunamis, tornadoes, terrorism, discoloration due to exposure to chemicals either directly or in the atmosphere, Acts of God/forces of Nature are not covered by this limited warranty.

Grill Models

Whether you are in need of a slimmer 28" grill for your patio, or are in need of a larger 36" grill that can entertain and bring style to any size party, Coyote has the grill for you!



Model No.	Product Size (inch/mm)	BTU/HR (Main)	Hood Light
C1P28	28" (711)	8,000/Per Lb.	Yes
C1P36	36" (914)	8,000/Per Lb.	Yes

Locating the Grill

Check your local building codes for the proper method of installation. If an external electrical source is utilized, this outdoor cooking appliance, when installed, must be electrically grounded in accordance with local codes. In the absence of local codes, this unit should be installed in accordance with the *National Electrical Code ANSI/NFPA No. 70* or the *Canadian Electrical Code CSA C22.1, 1990* or latest version.

- Before installing built-in grills in enclosures, copy all product information such as model number, serial number and store information in a safe place.
- If the grill is installed by a professional installer or technician, be sure that he or she shows you where your electrical supply shut-off is located.

Notice: We strongly recommend professional installation of your Coyote grill. These instructions provide the measurements necessary to construct a masonry structure to house your outdoor pellet grill.

LOCATION OF YOUR GRILL:



Locate the grill only OUTSIDE in a well-ventilated area. **Never locate the grill in a building, garage, breezeway, shed or other such enclosed areas without an approved ventilation system.** When in use, the grill will generate a lot of smoke. When installing your grill, select an outdoor location that will ensure there is adequate area for the smoke to dissipate IN ORDER TO AVOID INHALATION OF POTENTIALLY TOXIC FUMES.

Ventilation Requirements for Proper Operation of your Coyote Grill

- Ventilation for a pellet grill is absolutely mandatory to ensure that your grill performs as intended and to ensure the safety of you, your family, and guests. Proper ventilation is necessary to allow heat

inside your grill to escape.



- Failure to provide proper ventilation will nullify Coyote's warranty and will cause a risk of bodily injury or death.
- If you elect to install your grill into an island, the island itself must be ventilated properly. Any such island must have a minimum of 2 vents (but optimally 4 vents) per cabinet. Each vent must be at least 20 sq. in in size and have access to outside/fresh air. Those vents will allow heat that is trapped inside due to wind to be able to dissipate out of the island vents. However, if the island is not ventilated properly and the wind is coming from the back, then the heat will try to escape through the easiest exit, which will most likely be through the bottom of the grill and front control panel.



- A simple way to think of what is occurring inside your grill is that when your burners are on, they are emitting a flame that creates the heat to cook your food. This heat must exhaust or escape from the grill, otherwise you would eventually have a unit that would not only build up intense heat but also dangerous pressure. This could cause severe damage to not only the grill but any operators or people or property near-by. The grill itself allows for ventilation mainly through the rear of the unit above the rear panel but below the top of the hood. However, wind can act as a barrier to ventilation and exhaust. This blockage of exhaust can cause problems and hazardous conditions. Therefore, great care must be taken in selecting a location for your grill and in the installation of it into any masonry island or other outdoor structure. This can cause the control panel to get hot to the touch and possibly even burn your fingers.
- Ventilation and typical wind direction and conditions must always be considered when planning your

outdoor cooking island. Just the same as you would plan the layout and measure your indoor kitchen, you must also do the same for the outdoors; but you cannot forget about Mother Nature and the effects she can have on your outdoor cooking equipment.

- **Coyote Wind Guards:** If you do run into a situation where you will have wind coming into the back of the unit, the built in wind guard will help reduce the risks of overheating in the event of ventilation interference. Our Wind Guards should never be considered as a guaranteed solution to this problem. They are only intended to help the wind divert up and over the top of the grill. If the wind is strong, then you can still have problems with the heat being trapped in the hood. Coyote Wind Guards can be purchased through any of our authorized dealers.

Clearance:

- **FROM NON-COMBUSTIBLE MATERIALS:** Coyote grills can be placed directly on, or adjacent to, non-combustible materials, subject to ventilation requirements. The hood on a Coyote grill pivots mainly on the body. If you have a wall or partition behind the unit that would block ventilation, then a minimum of 7" clearance from the back of the grill to the wall is needed for the purpose of ventilation. If you do not have a wall or partition blocking the ventilation of the unit, then you only need an extra 3 ¼" behind the unit for the hood to open fully.
- **FROM COMBUSTIBLE MATERIALS:** Coyote grills must have at least 12" clearance from any combustible materials (in any direction) for the safety of the homeowner and for any Coyote Warranty to remain in effect. 
 - You CANNOT locate the grill under any combustible material without an approved ventilation system located directly above the unit. To elaborate, Coyote defines an approved ventilation hood as:
 - The ventilation hood chosen must be UL certified, produced for outdoor use and must be installed according to the hood manufacturer's specifications.
 - The hood must be installed at least 30" above the top of the cooking surface.
 - The hood must be at least 6" wider than the grill's frame (3" on each side), not just the cooking surface.
- **INSULATED JACKETS AND COMBUSTIBLE CONSTRUCTION:** If you elect to use combustible material to build your grill island AND the grill will be located within 12" of the combustible material, then you must use the appropriate Coyote insulated jacket. The insulated jacket will act as a barrier to protect your grill island from the heat and fire of your Coyote grill. If an insulated jacket is not used in a combustible material island, the warranty on the Coyote grill will be voided immediately and safety cannot be ensured.

For Built-in Installations

A built-in grill is designed for easy installation into masonry enclosures. For non-combustible applications, the grill drops into the opening and hangs from the grill body itself. A bottom deck is not required to support the grill from the bottom. It is also required that:

- A minimum of two ventilation holes in the enclosure, of at least 20 sq. inches in size (per vent), must be present.
- The counter should be flat and level relative to the floor.



High Elevation Installation and Use

Coyote Grills are designed to operate most efficiently at 0-2000 feet above sea level. From 2000-4000 feet above sea level you will not notice any substantial decrease in your heat. Above 4000 feet, you may experience longer cooking times on your grill than experienced at sea level. If you have questions or concerns regarding your location or elevation, please contact Coyote Customer Service for assistance.

Cut out Dimensions Figure A

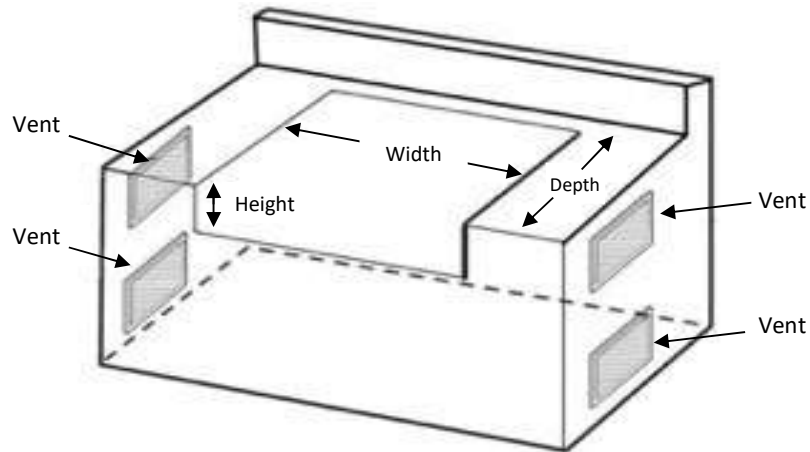

Minimum of 2 vents, *but optimally 4 vents*, per cabinet that has any sort of gas supply or connection. Each vent must be at least 20 sq. in. in size and have access to outside/fresh air. Two vents on each side will facilitate and improve airflow and ventilation.

Model	Cutout Dimensions			Overall Dimensions			Electrical Outlets Needed (120V)	
	Height	Width	Depth	Height	Width	Depth	Rotisserie	Lights
C1P28	16 ½"	26 ¼"	23"	31"	28"	27"	No	Qty 1
C1P36	16 ½"	34 ¼"	23"	31"	36"	27"	No	Qty 1

Electrical Requirements

NOTE: Coyote strongly recommends that a qualified service technician perform the initial installation.



This appliance is rated at 120v, 5a, 60 Hz and should only be serviced by a qualified service technician, or electrical shock may occur.

IMPORTANT: Electrical supply cords should be kept away

from any heated surfaces.

WARNING

Electrical Grounding Instructions:

The Coyote outdoor cooking appliance has a three prong (grounding) plug installed for your protection against shock hazard and should be plugged directly into properly grounded three prong outlets. Do not cut or remove the third prong from this plug.

Electrical equipment provided with the outdoor cooking appliance shall follow these guidelines:

1. Do not use the Coyote outdoor wood pellet grill for purposes other than intended;
2. Cord or plug should never be submerged, to avoid electric shock.
3. Make sure unit is completely cool before installing or removing parts.
4. Do not operate Coyote outdoor wood pellet grill with a damaged cord, plug, or after the appliance malfunctions or has been damaged in any manner. Contact the manufacturer for repair.
5. Do not let power cord touch hot surfaces;
6. When connecting, first plug appliance into outlet;
7. Use only Ground Fault Interrupter (GFI) protected circuit with this outdoor cooking appliance;
8. Plug should never be used with a two prong adapter or have the third grounding prong removed.
9. Use only outdoor rated three prong extension cords with a W-A marking, rated for the power of the equipment.

Storing and Loading Pellet

You should use always 100% Natural Hardwood BBQ Wood Pellets. They are no thicker than the eraser on the end of a pencil. These clean burning wood pellets generate about 8000 BTU's per pound with very little ash (.3lb/40lb bag) and low moisture content (5-7%) and are "carbon neutral". Barbeque wood pellets are produced in the same matter as wood pellet fuel is produced for home heating, PFI Standard Premium Grade, (See pelletheat.org). Pure raw material (sawdust) is pulverized with a hammer-mill and the material is pushed through a die with pressure. As the pellet is forced through the die it is sheared off at a specific maximum length, cooled, screened, vacuumed, and then bagged into 20 or 40 lb. bags.

Pellet Flavor Guide Lines

- **Apple** – Apple wood pellets are best used for smoking chicken, pork, lamb and seafood. It is mild and can be mixed well with others flavors.
- **Cherry** – Like Apple, cherry wood pellets are extremely universal and can be used to smoke anything.
- **Hickory** – When it comes to smoking pork, hickory cannot be beat. In addition to pork, both chicken and beef are also best paired with hickory flavored wood pellets.
- **Maple** – Best for chicken and vegetables, maple wood pellets are also similar to cherry and a great flavor to keep on hand.
- **Mesquite** – This flavor is the best wood pellet to use for beef; specifically for beef brisket.
- **Oak** – While oak is a mild flavor mostly used for filling and blended flavors, it can be used for all proteins and vegetables. It is another universal flavor to keep on hand at all times.
- **Pecan** – Pecan wood pellets are ideal for smoking chicken. This flavor can be blended with others, especially when smoking chicken.

TIP: Always store your pellets in a dry area. Avoid any contact or exposure to moisture. This will cause the pellets to absorb the moisture and will result in lower heat output or cause the pellets to swell and break apart. Use a moisture proof re-sealable tub or bucket.

Operating the Grill

DANGER WARNING

- NEVER stand with head, body, or arms over the grill when lighting.
- ALWAYS ensure the area around the barbecue is clear of flammable substances such as gasoline, yard debris, wood, etc.
- ALWAYS ensure there is no blockage of the airflow through the vent space located below the face of the unit.

GENERAL RULES

WARNING

NEVER leave the grill unattended while cooking!

- Make sure the grill is properly located, with necessary ventilation and clearances.
- Check that the end of each burner tube is properly located over each valve orifice.
- Light the grill burners using the instructions provided in this manual.
- Adjust heat settings to your desired cooking temperature.
- Allow grill to cool down, wipe off any splatters or grease and clean the drip tray.
- NEVER put a cover on the grill while it is still hot as it could start a fire.

DANGER

Keep any electrical supply cords and the fuel supply hose away from any heated surfaces.

Heating Element & Burner Pot

Picture 1



Picture 2



Picture 3



Picture 1 – Heating Element

- Heating element inside tube shown
- Two fans in the front blow hot air through the tube and ignite the pellets in the burner pot

Picture 2 – Burner Pot

- Burner pot pulled out of the grill
- Need to always make sure the holes are clean before each cooking session.

Picture 3 – Burner Pot Installed

- Burner pot installed above the heating element and ready for pellets to drop in.
- Pellets drop in from chute located on the front interior panel.

IMPORTANT – Make sure front of the burner pot is installed under the pellet chute. If the burner pot is installed incorrect it can prevent pellets from falling into the pot correctly.

Correct Burner Pot Installation



Correct Burner Pot Position

Incorrect Burner Pot Installation

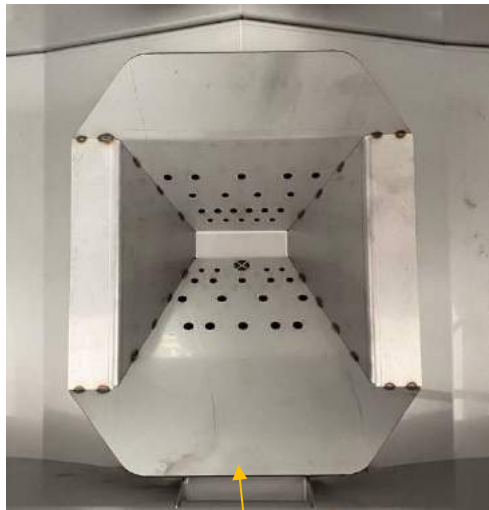

Incorrect Burner Pot Position

Pellet Drawer

Picture 1



Picture 2



Picture 3



Picture 1 – Dual Auger

- Front of grill pulls out to reveal dual auger and pellet hopper underneath.
- This “pellet drawer” pulls out on glides for easy access and secure closure.

Picture 2 – Pellet Hopper

- To fill the pellet hopper, simply take your pellets and drop them into the pellet drawer.
- You can fill up to the top of the drawer.
- Avoid getting any pellets inside the grill.

Picture 3 – Full Pellet Hopper

- Once the pellet drawer is full, you can close it back up.

Heat Shield with Smoking & Searing Grate

Picture 1



Picture 2



Picture 3



Picture 1 – Heat Shield

- Heat shield removed from grill to show the hole where you insert the smoking or searing grate.

Picture 2 – Smoking Grate

- Smoking grate installed into heat shield
- You would use the smoking grate for any in-direct cooking (slow and low, smoking, etc)

Picture 3 – Sear Grate

- Searing grate installed into heat shield
- You would use this for any direct heat cooking (searing, quick hamburgers, high-heat, etc)
- Always install when cooking in sear mode.



Smoking Grate Removal Tool

- All pellet grills come with a tool to help remove the smoking grate
- The sear grate has actual handles built into it for easy removal

3-in-1 Versa-Rack, Gasket

2nd Tier – Single Rack Installed



2nd Tier – Double Rack Installed



Versa-Rack Setup includes 2 different sets of rails:

- First set includes shorter rails and one rack
- Second set includes longer rails and 2 additional racks
- To remove the brackets lift up from the front and slide forward.

GRILLING MODES

The Coyote Pellet Grill and Smoker has three different grilling modes depending on the type of food you will be cooking Smoke Mode, Grill Mode, & Sear Mode. Grill, Smoke are determined by setting the target temperature, and the grill will automatically maintain your target temperature setting. The sear mode functions separately and is designed to be used only with the searing grate.

- **SMOKE Mode** - Target Temp (175F - 300F) This mode will be used for most types of cooking. In this mode a moderate amount of smoke will be generated.

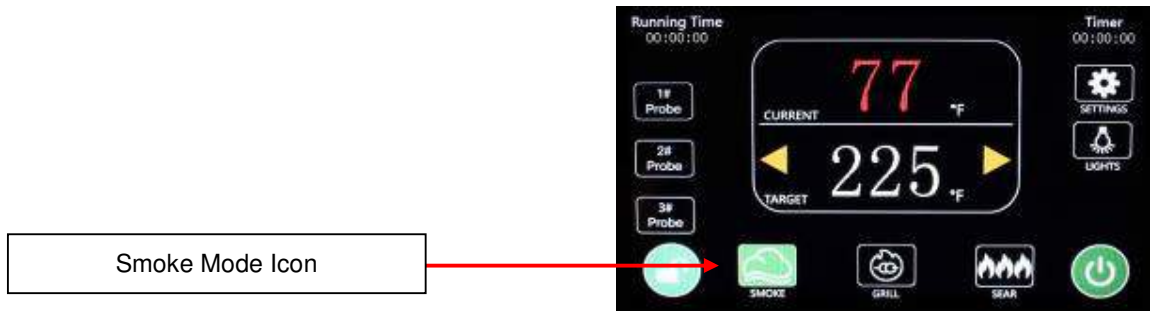

- **GRILL Mode** – Target Temp (301F - 700F (650F 28" Version)) This mode will allow you to cook at higher temperature.



- **SEAR Mode** – (*Must use the Sear Grate in this mode*) Allows you to cook at high temperatures to sear in the juices. To use the Sear mode press the sear mode icon. The grill will automatically begin the ignition process, if it is not already started. Press the Low, Medium or High Button to control the sear temp. To exit sear mode press the sear button and the grill will go back to the last grill mode and temp setting.

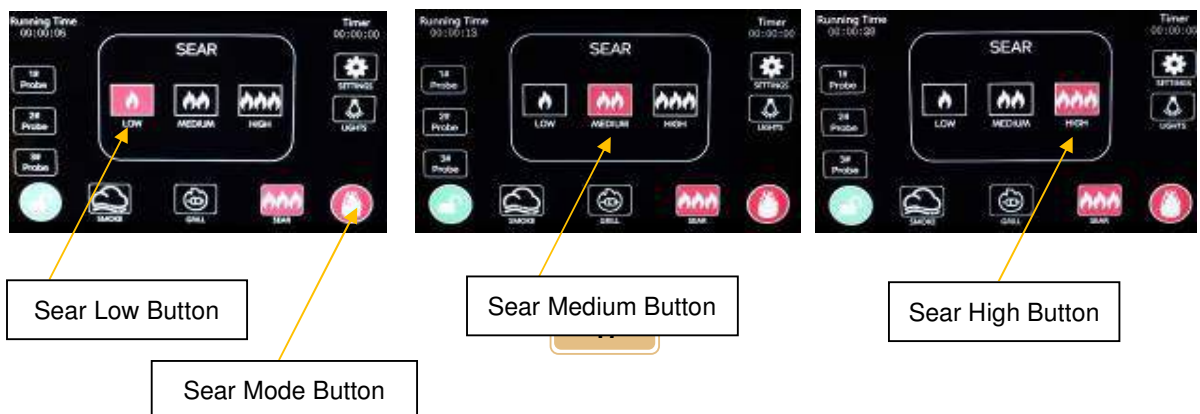

Using the Digital Display

PELLET GRILL OVERVIEW

- Filling the Hopper and Auger
- Lock / Unlock Display
- Setting the Temperature
- Grill Startup & Grill Shutdown
- Halogen Lights
- Using the Timer
- Using Temp Probes
- Settings Menu
- Changing the Passcode

FILLING THE HOPPER AND AUGER

Before you can start smoking, you will need to fill the hopper with pellets.



1. Open the hood, pull the hopper cover towards you and fill with your preferred type of pellets. Then close hopper.
2. Remove any pellets that may have fallen into the firepot. They may be reused if they are not burned.
3. Once the grill is started the auger will automatically drop the pellets into the burner pot for ignition.
4. The smart drop technology will continue to feed pellets and will hold the target temperature until the unit is shutdown or out of pellets.

Locking and Unlocking the Display

When the grill is powered on, the display will be locked by default. On the bottom left corner of the display screen there is a red button with a “LOCK” icon. To unlock the display, press the lock icon for **three seconds**. The button will turn green and display an “UNLOCK” Icon. You can now use the display screen to set the temperature and start the grill. See images below.

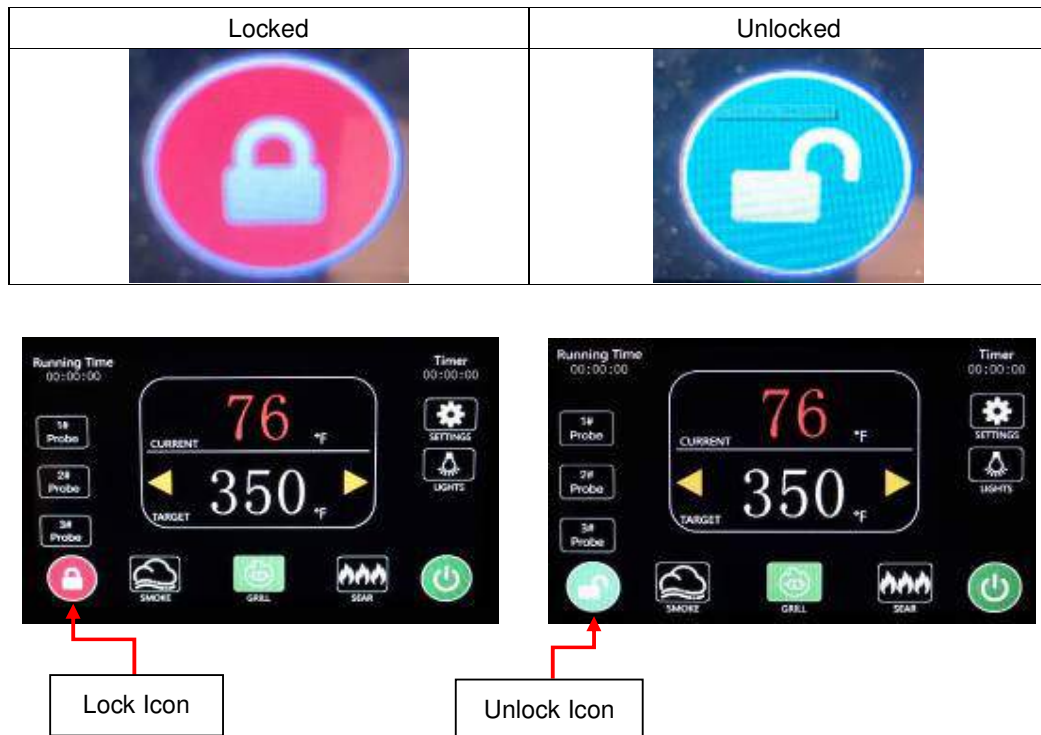

Setting the Temperature

To set the grill cooking temperature, press the target temp area of the display and the target temp keypad will appear. Enter the target temperature desired and press the green check button. You can also press the yellow arrows in the target temp area to make small adjustments to the temperature.

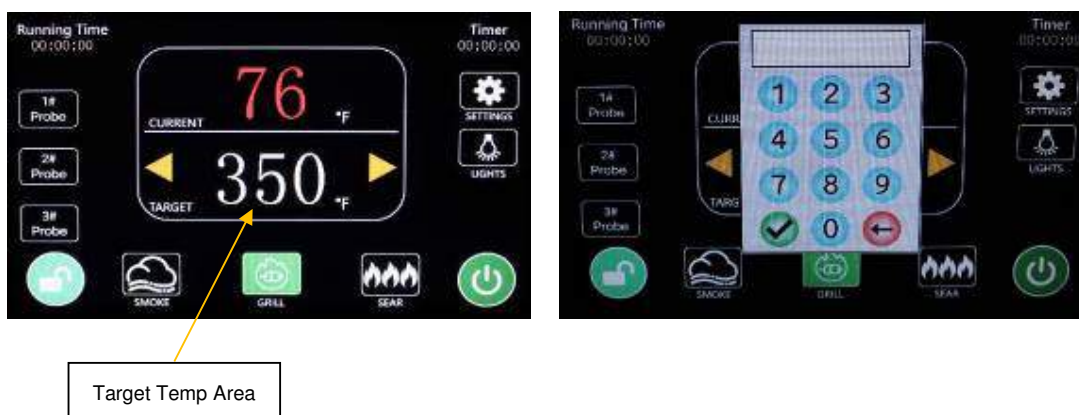

Startup and Shutdown

Once you are ready to grill you will use the touch screen display to startup and shutdown the grill.

IMPORTANT: Prior to operating the grill in any capacity, ensure that the firepot is clear of any ash build-up or unburned pellets. Make sure the Firebox is clean of any ash build up or grease. Making sure that the inside of your pellet grill is clean and clear. This will help with the longevity of your grill, so make sure this process is done regularly.

STARTUP

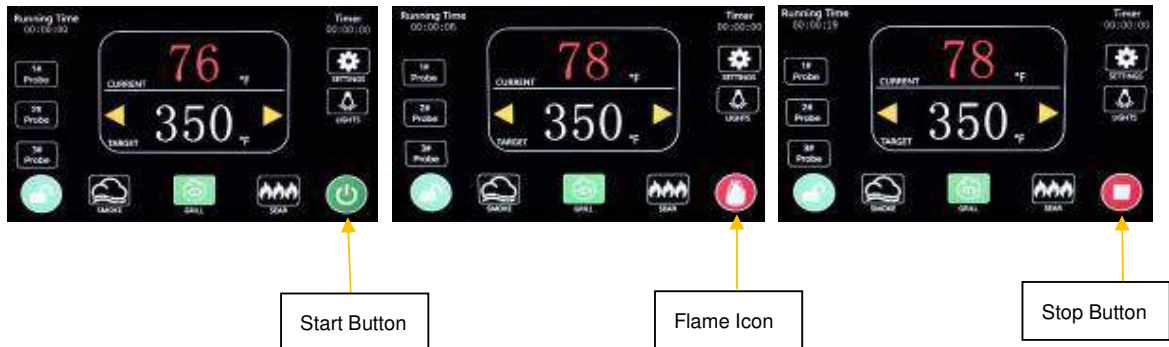

To startup your grill;

1. First you will need to select and fill the pellet hopper with your preferred all natural wood cooking pellets. (*Ensure the pellets are completely dry.*)
2. Press the power button on the left side of the control panel to turn the grill on. The screen will light up and a Coyote Logo will appear.
3. The grill will go into "Start-Up" mode and the display will be locked by default. To unlock the display, press the red lock button for **three seconds**.
4. Once in "Start-Up" mode you will be able to set the target temperature and timer to the setting that is ideal for the food you are cooking.
5. Once your target temperature and timer are set press the green start button at the bottom right of the display to fire up the grill. A flame icon will appear, the igniter will stay on for 5 minutes by default. (*The ignition time can be adjusted in the settings menu.*)
6. Once the grill is ignited, the flame logo will change into a red stop button.

SHUTDOWN

Once finished cooking your food, now it is time to shut down your Coyote Pellet Grill and Smoker.

To shut down your grill;

1. First press the red stop button. This will stop the auger off and the fan speed will increase the fan speed. A dialog box will appear on the screen notifying you that the grill has gone into Cooldown Mode.
2. Cooldown Mode will proceed until the temperature of the unit reads 160°F internally. Once 160°F has been reached the Cooldown feature has finished and the fan will shut off.

3. There is an Exit button to manually bypass the Cooldown feature if you intend to continue grilling. *(It is not recommended to bypass the Cooldown Mode.)*
4. It is now safe to power down your grill by pressing the orange power button on the bottom left corner of the control panel.

Using the timer

To use the timer simply press the timer button in the top right corner of the display and timer keypad will appear. After setting the timer, when the time counts down to zero the grill will beep and a clock icon will display on the screen. Tap the clock icon to stop the alarm beep.

(Timer does not have an effect on the temperature and will not stop the grill when time is up.)

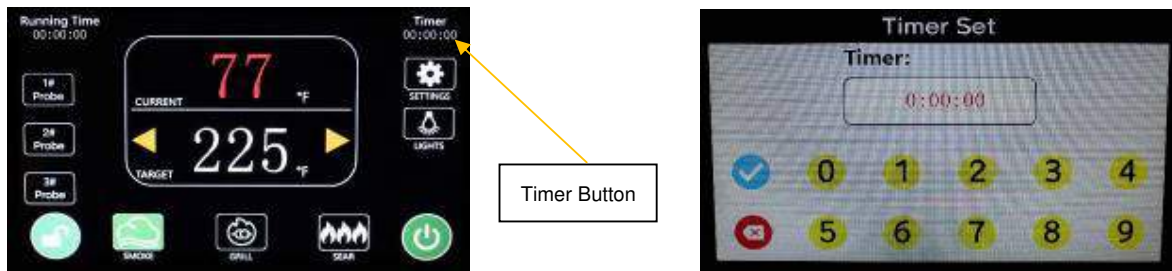

Halogen Lights

The Coyote Pellet Grill and Smoker comes equipped with two interior halogen lights. To turn the lights ON/OFF simply press the lights button on the right side of the display. The button will be green when the lights are on.

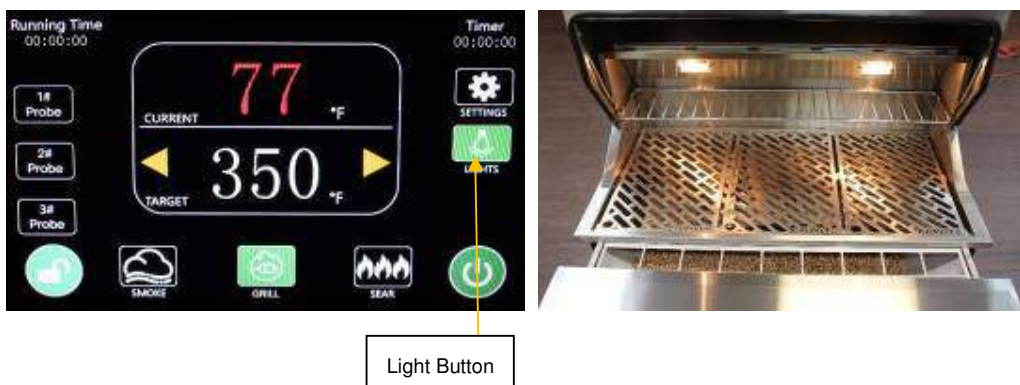

Temp Probes

Your pellet grill includes 3 temperature probes to monitor internal temperatures of the meat you are cooking. Simply plug the probes into one of the ports on the left side of the grill panel and the other end into the meat. (Cover port openings when not in use.)



Settings Menu

On the right side of your grill display there is a setting button. In order to access the setting menu you will need to enter a system password. The default password is 1234.



Once the menu is unlocked there are several settings that can be adjusted.

1. **Temperature** – Toggle between C and F, with F being default.
2. **Feeding Time** – After lighting the pellets will continue feeding for 80 seconds
3. **Startup Time** – After Lighting the glow plug will continue heating for 300 seconds.
4. **Startup Temp Differential** – After lighting and temperature reaches >40F, the startup is successful. If it is under <40F after 18 minutes, a “Temperature Warning” screen will popup.
5. **Addtl Startup Temp Differential** - If temperature drops 32F while grill is running, the glow plug will kick in for additional firing to prevent fire from going out.
6. **Over Heat Alarm** – Max heat for 36” is 700F and 650F for 28”. If grill reaches 750F, there will be an alarm.
7. **Low Temp Alarm** – When Temperature drops 50F, a temperature warning screen will popup. If the continue button is not pressed in 22 minutes, the grill will go into shutdown mode.

Changing the Password

If necessary the system password can be changed. While the password keypad is displayed there is a yellow keypad at the top right corner. Enter the default 4 digit password and press the key icon. The change password keypad will appear. You will be to change your password to any 4 digit number. (If you change the password make sure you write the password down.)

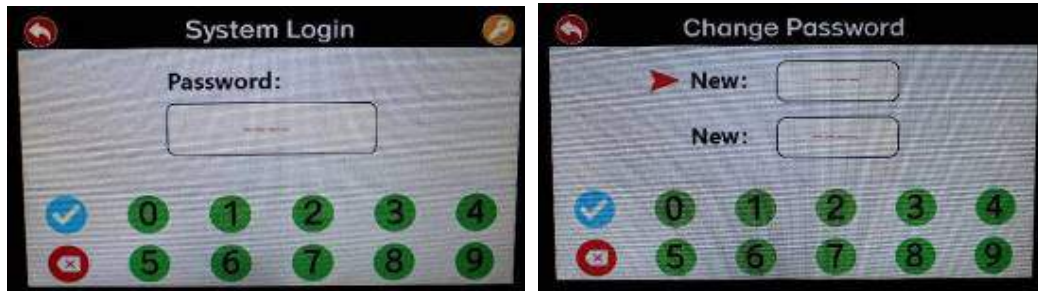

The table below shows general guidelines to follow when learning to use your new Pellet Grill and Smoker. We recommend experimenting with times and temperatures to get the flavor you desire. You are able to speed up the cooking process on a higher temperature but be warned that this could result in a less tender product. We recommend that enough time is adequately set aside to get the best results every time.

Meat Temperatures & Doneness Chart Recommended by USDA

MEAT	Rare	Med Rare	Medium	Med Well	Well Done
Ground Beef			160°F/71°C		
Ground Poultry			165°F/74°C		
Beef	125°F/52°C	140°F/60°C	150°F/66°C	160°F/71°C	165°F/74°C
Veal	125°F/52°C	140°F/60°C	150°F/66°C	160°F/71°C	165°F/74°C
Chicken			165°F/74°C		
Pork			160°F/71°C	165°F/74°C	170°F/77°C
Poultry			165°F/74°C		
Lamb	140°F/60°C	145°F/63°C	160°F/71°C	165°F/74°C	170°F/77°C
Fish			145°F/63°C		

Preparing Food for the Grill



WARNING

Always observe safe food-handling and safe food-preparation practices when using this Grill, to prevent food-borne illnesses.

- Always cook foods adequately. Undercooked foods can retain bacteria, especially if thawed or exposed to warm conditions prior to cooking.
- Always use separate plates and utensils for the handling of raw food. Never place raw food and cooked food on the same plate, and never place cooked food on a plate that was used for handling raw food.
- Always carefully wash all plates and utensils used to handle raw food before using them to handle cooked food.
- Always wash all vegetables, seafood and poultry before cooking.
- Always leave uncooked foods in the refrigerator until you are ready to start cooking.
- Always marinate meat in the refrigerator. Dispose of the excess marinade, and never reuse it.

Grilling Tips:

- If you pre-cook meat or poultry, do so immediately before grilling.
- Refrigerate leftovers within 2 hours of taking food off the grill.
- Never let the tray boil dry, as that could be hazardous. Grease from fatty foods that have collected in the tray could ignite and possibly cause bodily injury or property damage.
- Use a meat thermometer to be sure food has reached a safe internal temperature.
- Always trim excess fat from your foods to reduce the occurrence of flare-ups during cooking.
- Apply a light coating of cooking oil to the cooking grids before grilling, to prevent foods from sticking.
- Cook similar portion sizes together, so that they all cook evenly.
- Use tongs to turn foods on the grill.
- Never pierce foods while they are cooking on the Grill, as this will dry them out.
- Turn foods infrequently. Some chefs say that a good steak should never be turned more than once.
- Apply sugar-based sauces such as commercial barbecue sauces only during the latter stages of cooking, to prevent charring.

- Soak the string you use to tie up roasts and poultry on the rotisserie spit to protect it from burning.
- Use a disposable aluminum tray filled with water, fruit juice, wine or a marinade to add extra flavor and moisture to slow-cooked foods like roasts, whole chickens, turkeys or ducks.

Controlling Flare-ups



Excessive flare-ups resulting from the build-up of grease in the bottom of the grill can over-cook the food and cause a dangerous situation for you and your grill. If this should occur, DO NOT pour water onto the flames, which can cause the grease to splatter and could result in serious burns or bodily harm. If grease fire occurs, close the hood and shutdown the grill until the grease burns out. Use caution when opening the hood as sudden flare-ups may occur.

To Minimize Flare-ups:

- Trim excess fat from meats prior to cooking.
- Ensure that your grill is on level ground and the grease is allowed to evacuate the grill through the drain hole.

Care & Maintenance



All cleaning and maintenance should be done only when grill is cool & with the power supply turned off.

DRIP TRAYS

The drip trays located below the grill should be cleaned periodically to prevent buildup of debris.

NOTE: Allow the drip tray to cool before attempting to clean.

IMPORTANT: Do not leave the grill outside during inclement weather unless it is covered (cover sold separately). Rain water can collect inside the grill, the grill cart or the drip trays if left uncovered. If the drip tray is not cleaned after use and the grill is left uncovered, the drip tray will fill with water causing grease and water to spill into the grill cart. We recommend cleaning and the drip tray after every use.

COOKING GRATES

The cooking grates can be cleaned immediately after cooking is completed and after turning off the grill, but exercise extreme caution because the grates will be very hot if you clean them immediately after cooking. Always wear a barbecue mitt and scrub the cooking grates with a damp cloth. If the grill is allowed to cool down, cleaning the grates will be easier if removed from the grill and cleaned with a mild detergent.

HEAT SHEILD

Washing the heat shield after every use is not necessary but periodically it is suggested you wash it in a soap and warm water solution. Do not clean the heat shield immediately after use of the grill. Allow it to cool. Use a wire brush to remove stubborn burned on cooking residue. Dry the heat shield thoroughly before you reinstall it in the cooking insert.

Stainless Steel Care and Maintenance

It is a common misconception that stainless steel will maintain its original factory shine with little help from the consumer. Unfortunately, this is not true. Stainless steel will not stain, discolor, corrode or rust as fast as other types of steel, but it is not fully stain or weather proof. If it is not properly maintained, all grades of stainless steel can face surface discoloration, corrosion and eventually rust. Any stainless steel that is exposed to the environment will require attention and care throughout its life to ensure that it keeps its shine and structural integrity.

Cleaning the Stainless Steel and Polishing

1. Allow grill to cool before cleaning/polishing stainless steel. Do not clean or polish your grill's stainless steel when the grill is in operation or still hot.
2. To clean the stainless steel, wash off all dirt and debris from the steel with warm water. If you have tough spots to clean, then a third-party degreaser product can be used.
3. Next, rinse and dry the steel thoroughly with a clean towel. Do not allow the steel to air dry as the standing water can cause surface discoloration.
4. The last step is to protect to the unit with a good third-party polish. There are several third-party polishes on the market that will help keep your grill protected from the elements for a longer period of time. Most of these polishes are toxic, so only use these on the exterior of the grill. Follow instructions provided on any third-party polish products. Do not use such products on cooking grates or heat control grids.
 - a. Apply the polish to a clean paper towel and wipe with the direction of the grain in the stainless steel.
 - b. There should be no excess liquid on the surface but it is acceptable for it to be a little oily, as that will dissipate.
5. If your grill has developed surface discoloration or surface rust, clean the unit as stated above and use a good third-party polish to remove or reduce the spots. Follow instructions provided on any third-party polish products. Coyote does not insure or guarantee the performance of or results from such products.

Environmental Factors that can affect your Grill

There are several typical causes for surface discoloration and corrosion on your stainless steel outdoor equipment:

1. Mortar (which contains lime) from the island assembly process has rested on the unit for a prolonged period of time and the unit was not cleaned quickly.
2. Pool chemicals were splashed onto the grill (chlorine and acid will cause problems quickly) and the unit was not cleaned off promptly.
3. Hard water from sprinklers (chlorine in the water) was allowed to sit on the unit.
4. Salt from the ocean air/water was allowed to rest upon the grill for a prolonged period of time before being cleaned (beach owners must be diligent in maintaining their outdoor stainless equipment).
5. Dust, or rust, from other metals found its way onto the grill and was left on for an extended period of time.
6. Organic matters (such as certain types of food) might have gotten onto the surface of the grill and it was then covered. With high humidity and low oxygen, corrosion will start to take place.
7. Sprays and cleaning solutions containing alkaline, lime, acid, salt, etc. might have been left on the grill surface un-dried.

8. Failure to clean or polish your grill in accordance with the instructions above

Ways to Avoid Rust on your Grill:

1. Purchase a Coyote Grill cover for your unit. This will ensure that your cover is a correct fit and breathable, while providing the protection needed to keep contaminants off of the surface.
2. When installing the unit, make sure to keep the unit covered when any masonry work is being performed. If any mortar or dust does come into contact with the stainless, make sure to wipe it off as soon as possible and use a stainless steel polish immediately afterward.
3. Position your grill away from areas that can receive water splash from a pool or hot tub.
4. Do not store pool chemicals in your island or island cabinets.

How to Remove Scratches from your Stainless Steel:

If your situation is a little more serious and you have obtained scratches in your equipment, then you will need to purchase a third-party stainless steel scratch kit. These kits are popular in retail stores but can be easier to obtain online. With these kits, you will not polish the unit until you are done re-scratching the entire product you are working on. With a scratch kit, the goal is to literally re-scratch the entire surface, so that the original grains are replaced by your new scratched-in grains. With this practice, you must be willing to treat the entire surface or you will notice a start and stop point. Also, be careful to pay attention to your rolled or finished edges as these scratch kits will ruin this finish. After you have used the kit, you will want to follow it up with a good stainless polish (as mentioned prior) and then a dry towel for a final wipe down. Follow all directions on any third-party stainless steel scratch kits. Coyote does not insure or guarantee the performance of or results from such products.

HOW TO CHANGE THE LIGHT BULBS

1. Remove the screw holding the bulb lens.
2. Reach in using your fingers only, grip the two outside edges of the light bulb. Do not grip the top or bottom of the bulb, as it might break. Pull the bulb straight out, so that the two electrode wires are completely removed with bulb. Place bulb in trash.
3. When installing the new halogen bulb be sure to use a clean cloth or paper towel to ensure the longevity of the bulb.
4. Insert the new bulb using your clean cloth and gently snap it into position. Wipe off any fingerprints and/or grease that may have transferred to the bulb.
5. Re-install the bulb lens and cover
6. Flip the switch on to check lights.

CLEANING OF GRILL HOUSING

1. After each cooking session, or before you start one, you should give the entire grill a thorough cleaning to keep it in top operating condition.
2. Allow grill to cool down completely.
3. Remove and clean the cooking grids, heat shield and burner pot.
4. Remove warming rack and wash with mild detergent and warm water.
5. Brush the inside and bottom of the grill with a stiff wire brush, and wash down with a mild soap and warm water solution. Wash thoroughly and let dry.
6. Reinstall heat shield, cooking grids, burner pot and racks as needed.
7. Reconnect to power source.

IMPORTANT: You should NOT line the bottom of the grill housing with aluminum foil, sand or any other grease absorbent substance. Grease will not be able to drip into the drip tray and a grease fire may occur.

MAINTENANCE GUIDELINES

1. Keep outdoor cooking appliance area clear and free from combustible materials, gasoline and other flammable vapors and liquids.
2. Do not obstruct the flow of combustion and ventilation air.
3. Keep the ventilation opening(s) of the cylinder enclosure free and clear from debris.
4. Clean outdoor cooking appliance, including special surfaces, with recommended cleaning agents, if necessary.

Troubleshooting Your Grill

GENERAL TROUBLESHOOTING

Inspect your burner pot immediately if any of the following conditions occur:

- The grill will not get hot enough.
- The grill heats unevenly.



SPIDER AND INSECT WARNING: Spiders and insects can nest in the body of this and other grills, which could disrupt air flow. This dangerous condition could cause a fire behind and beneath the valve panel, damaging the grill and making it unsafe to operate. We recommend you check the grill and remove any spiders, insects and webs at least once a year to reduce this risk.

WHEN TO LOOK FOR SPIDERS/INSECTS

You should inspect the burners once a year or immediately after any of the following conditions occur:

1. The grill does not reach temperature.
2. The grill heats unevenly.

TROUBLESHOOTING

If the grill does not function properly, use the chart below to assist in diagnosing the problem. Troubleshooting is for general purposes only. ALWAYS ERR ON THE SIDE OF SAFETY. If the problem still exists, contact our Coyote Customer Service line at 855-520-1559.

Problem:	Possible Causes and Solutions:
Flare-ups	<ul style="list-style-type: none"> • Check heat shield and cooking grates for excess food or grease build-up. • Ensure grill is not placed directly in the path of wind. • Be sure drip trays are clean (do not use aluminum foil on drip tray.) <p>Note: Some flare-ups may be inevitable if cooking greasy foods.</p>
Grill is Too Hot	<ul style="list-style-type: none"> • Excess grease build-up causing grease fires. • Burner pot may have too many pellets at startup. • Set grill to a lower temperature setting.
Grill will not turn on	<ul style="list-style-type: none"> • Check to make sure grill is plugged into a working outlet. • Make sure burner pot is clear of pellets or buildup. • Adjust the feeding time for startup in the settings menu (default is 80 seconds)
Grill shuts off	<ul style="list-style-type: none"> • Adjust the low temp alarm in the setting menu. (default is 5 minutes) • If you cannot find the reason, call Customer Service at 855-520-1559 for assistance.

Grill Exploded View

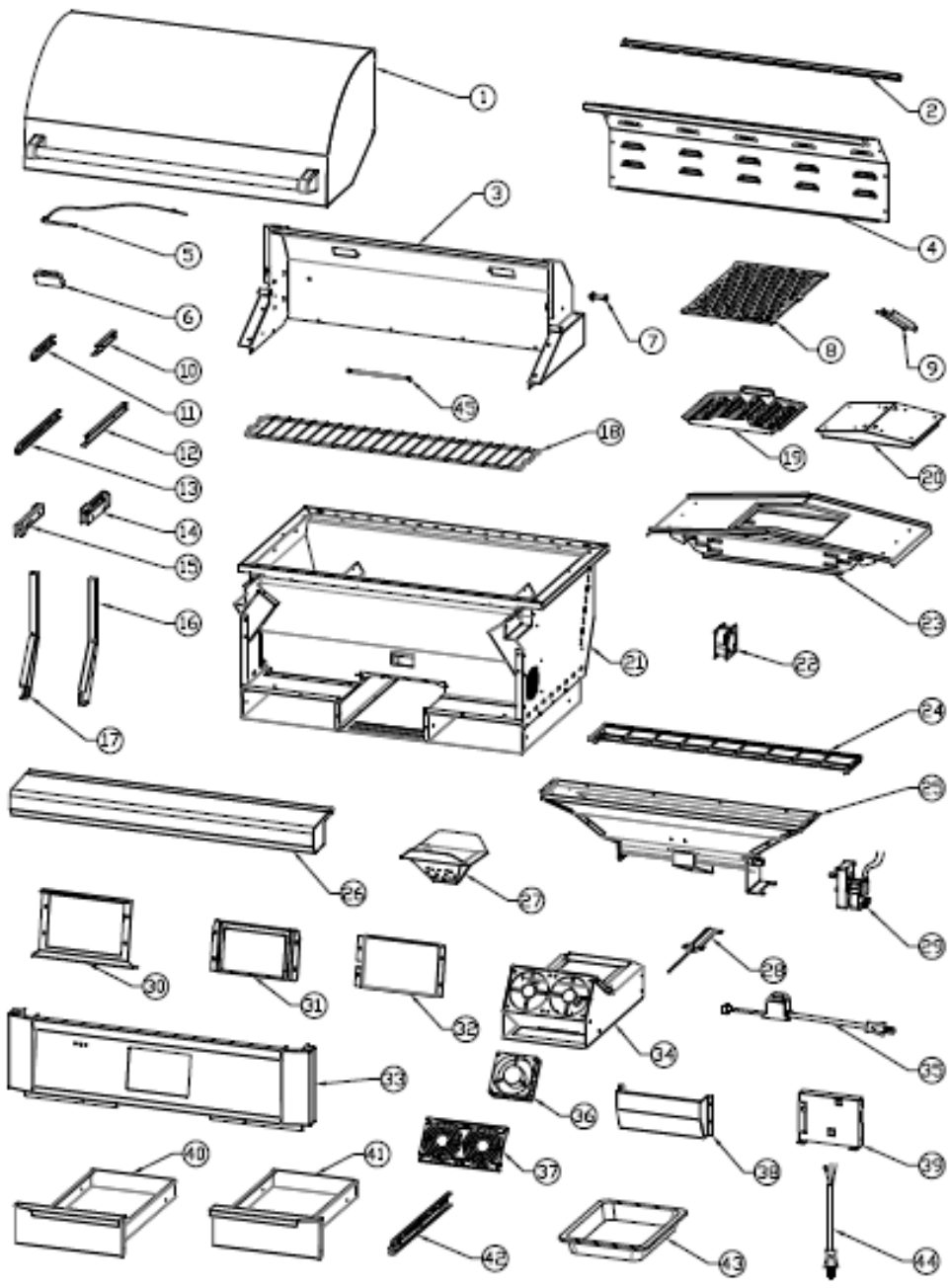

C1P28 Parts List

Part #	Name	Qty	Part #	Name	Qty
C1P28001	Hood - C1P28	1	C1P28024	Hopper Baffle - C1P28	1
C1P28002	Wind guard - C1P28	1	C1P28025	Hopper - C1P28	1
C1P28003	Lower Hood - C1P28	1	C1P28026	Hopper Cover - C1P28	1
C1P28004	Rear Panel - C1P28	1	C1P00027	Burner Pot	1
C1P00005	Temperature Probe	1	C1P00028	Igniter	1
C1P00006	Halogen Light	2	C1P00029	Auger Motor	1
C1P00007	Hood Mounting Bolt	2	C1P00030	LCD Mounting Panel	1
C1P28008	Cooking Grate - C1P28	3	C1P00031	LCD panel	1
C1P00009	Grate Removal Tool	1	C1P00032	LCD Screen Shield	1
C1P00010	Small Warming Rack Bracket Right	1	C1P28033	Control Panel - C1P28	1
C1P00011	Small Warming Rack Bracket Left	1	C1P28034	Fan Assembly - C1P28	1
C1P00012	Large Warming Rack Bracket Right	1	C1P00035	Transformer	1
C1P00013	Large Warming Rack Bracket Left	1	C1P00036	Fan	2
C1P00014	Pellet Drawer Slide Right	1	C1P28037	The Fan Cover - C1P28	1
C1P00015	Pellet Drawer Slide Left	1	C1P00038	Inlet Shield	1
C1P00016	Through right	1	C1P28039	Circuit Board Box - C1P28	1
C1P00017	Trough left	1	C1P28040	Drip Tray Drawer Left - C1P28	1
C1P28018	Warming Rack - C1P28	3	C1P28041	Drip Tray Drawer Right - C1P28	1
C1P00019	Sear Grate	1	C1P00042	Drawer Glide	4
C1P00020	Smoking Grate	1	C1P28043	Drip Pan - C1P28	2
C1P28021	Firebox - C1P28	1	C1P00044	Power Cord	1
C1P00022	Firebox Fan	1	C1P00045	Hood Spring	2
C1P28023	Heat Shield - C1P28	1	-	-	-

C1P36 Parts List

Part #	Name	Qty	Part #	Name	Qty
C1P36001	Hood - C1P36	1	C1P36024	Hopper Baffle - C1P36	1
C1P36002	Wind guard - C1P36	1	C1P36025	Hopper - C1P36	1
C1P36003	Lower Hood - C1P36	1	C1P36026	Hopper Cover - C1P36	1
C1P36004	Rear Panel - C1P36	1	C1P00027	Burner Pot	1
C1P00005	Temperature Probe	1	C1P00028	Igniter	1
C1P00006	Halogen Light	2	C1P00029	Auger Motor	1
C1P00007	Hood Mounting Bolt	2	C1P00030	LCD Mounting Panel	1
C1P36008	Cooking Grate - C1P36	3	C1P00031	LCD panel	1
C1P00009	Grate Removal Tool	1	C1P00032	LCD Screen Shield	1
C1P00010	Small Warming Rack Bracket Right	1	C1P36033	Control Panel - C1P36	1
C1P00011	Small Warming Rack Bracket Left	1	C1P36034	Fan Assembly - C1P36	1
C1P00012	Large Warming Rack Bracket Right	1	C1P00035	Transformer	1
C1P00013	Large Warming Rack Bracket Left	1	C1P00036	Fan	2
C1P00014	Pellet Drawer Slide Right	1	C1P36037	The Fan Cover - C1P36	1
C1P00015	Pellet Drawer Slide Left	1	C1P00038	Inlet Shield	1
C1P00016	Through right	1	C1P36039	Circuit Board Box - C1P36	1
C1P00017	Trough left	1	C1P36040	Drip Tray Drawer Left - C1P36	1
C1P36018	Warming Rack - C1P36	3	C1P36041	Drip Tray Drawer Right - C1P36	1
C1P00019	Sear Grate	1	C1P00042	Drawer Glide	4
C1P00020	Smoking Grate	1	C1P36043	Drip Pan - C1P36	2
C1P36021	Firebox - C1P36	1	C1P00044	Power Cord	1
C1P00022	Firebox Fan	1	C1P00045	Hood Spring	2
C1P36023	Heat Shield - C1P36	1	-	-	-

Cart Exploded View

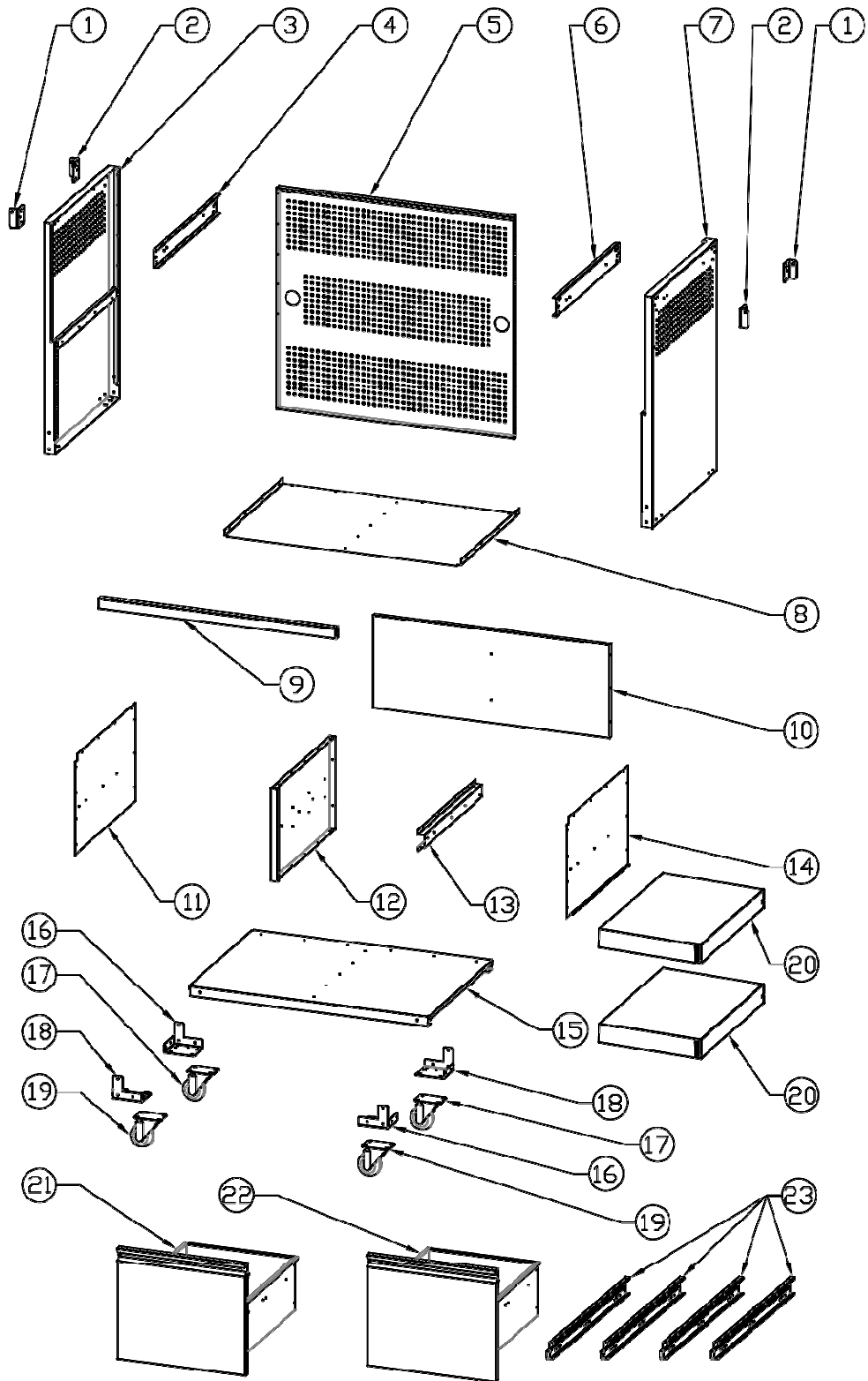

C1P28FS Parts List

Part #	Name	Qty	Part #	Name	Qty
C1PFS00001	Side Shelf Holder A	2	C1PFS00013	Slide Holder	1
C1PFS00002	Side Shelf Holder B	2	C1PFS00014	Side plate of drawers - Right	1
C1PFS00003	Side Panel - Left	1	C1P28FS015	Bottom Panel - C1P28FS	1
C1PFS00004	Side Shelf Inner Holder - Left	1	C1PFS00016	Wheel holder A	2
C1P28FS005	Back Panel - C1P28FS	1	C1PFS00017	Wheel	2
C1PFS00006	Side Shelf Inner Holder - Right	1	C1PFS00018	Wheel holder B	2
C1PFS00007	Side Panel - Right	1	C1PFS00019	Locking Wheel	2
C1P28FS008	Top plate of drawers - C1P28FS	1	C1PFS00020	Side Shelf	2
C1P28FS009	Top Rail - C1P28FS	1	C1P28FS021	Left Drawer - C1P28FS	1
C1P28FS010	Back plate of drawers - C1P28FS	1	C1P28FS022	Right Drawer - C1P28FS	1
C1PFS00011	Side plate of drawers - Left	1	C1PFS00023	Slide	4
C1PFS00012	Middle plate of drawers	1	-	-	-

C1P36FS Parts List

Part #	Name	Qty	Part #	Name	Qty
C1PFS00001	Side Shelf Holder A	2	C1PFS00013	Slide Holder	1
C1PFS00002	Side Shelf Holder B	2	C1PFS00014	Side plate of drawers - Right	1
C1PFS00003	Side Panel - Left	1	C1P36FS015	Bottom Panel - C1P36FS	1
C1PFS00004	Side Shelf Inner Holder - Left	1	C1PFS00016	Wheel holder A	2
C1P36FS005	Back Panel - C1P36FS	1	C1PFS00017	Wheel	2
C1PFS00006	Side Shelf Inner Holder - Right	1	C1PFS00018	Wheel holder B	2
C1PFS00007	Side Panel - Right	1	C1PFS00019	Locking Wheel	2
C1P36FS008	Top plate of drawers - C1P36FS	1	C1PFS00020	Side Shelf	2
C1P36FS009	Top Rail - C1P36FS	1	C1P36FS021	Left Drawer - C1P36FS	1
C1P36FS010	Back plate of drawers - C1P36FS	1	C1P36FS022	Right Drawer - C1P36FS	1
C1PFS00011	Side plate of drawers - Left	1	C1PFS00023	Slide	4
C1PFS00012	Middle plate of drawers	1	-	-	-

WIRING DIAGRAM

