

This Owner's Manual is provided and hosted by [Appliance Factory Parts](#).



# Beefeater 1000R Owner's Manual

[Shop genuine replacement parts for Beefeater 1000R](#)



[Find Your Beefeater Grill Parts - Select From 11 Models](#)

----- Manual continues below part list -----

**Available Replacement Parts for Beefeater 1000R**

[BFE94701](#)

Burner



Australia  
North America

# Discovery Series Barbecues



**Assembly And Operating Instructions**

For outdoor use only

i-1000<sub>R</sub>



# Safety Warnings



**WARNING:** We want you to enjoy your barbecuing experience - Failure to follow the instructions and observe the warnings provided in this operating manual could result in serious bodily injury or damage to property. Please read these instructions completely before assembly or operation of your barbecue.

**NOTE TO INSTALLER:** This manual must remain with the owner for future reference.

## For Your Safety

1. Do not store or use gasoline or other flammable vapours or liquids in the vicinity of this or any other appliance.
2. An LPG cylinder not connected for use shall not be stored in the vicinity of this or any other appliance.

## For Your Safety

If you smell gas:

- Shut off gas to the appliance
- Extinguish any open flame.
- Open lid.
- If odour continues, immediately call your gas supplier or your fire department.

**Below is a summary of important safety warnings and advice. *It is not a complete list.* Ensure you are completely familiar with the entire instruction booklet before installation or operating the barbecue.**

## Installation Safety

Warning: Contact your local municipality for any building codes regulating the installation of outdoor barbecue appliances. Outdoor installations must conform to local codes or, in the absence of local codes, with the following:

- USA: National Fuel Gas Code, ANSI Z223.1/NFPA 54
  - CAN: CGA: B149.1 Natural Gas & Propane Installation Code.
  - AUST/NZ: Australian Standards Code AS: 5601
- as well as the requirements of any local council, gas, electricity authority or other statutory regulation. Spanner tighten all gas fittings as per instructions.

## Safe Location

Do not use barbecue indoors. This is an outdoor cooking appliance. It must only be used outdoors, and must not be used in a building, garage or any other enclosed area.

Do not store combustible materials, gasoline or flammable liquids or vapours within 45 cm (18") of barbecue.

This barbecue is not designed for marine use, and shall not be installed on a boat or any marine craft.

Keep the barbecue and cylinder well ventilated. Do not obstruct the flow of air around the barbecue, as this is required for proper combustion.

For built-in situations, allow adequate ventilation for the barbecue and cylinder, and adequate protection from adverse weather.

Allow clear access to the entire gas supply hose and regulator.

Use your barbecue only on a level surface.

## Gas Cylinder Safety

Do not install the gas cylinder beneath the barbecue unless in conjunction with an approved trolley.

Keep the cylinder protected from heat.

Only one gas cylinder may be attached to the appliance at any one time.

When using an LPG supply system (eg portable LPG cylinder) in an enclosure, ventilation must be provided. Keep ventilation opening of any cylinder enclosure clear and free of any debris. Gas vapour is highly explosive and can cause serious bodily injury or damage to property if allowed to accumulate in a confined space and ignited.

Have the gas cylinder filled by an authorised LPG supplier.

Close the gas cylinder valve after each use.

Do not smoke or use a naked flame near the gas cylinder while disconnecting the gas line between the appliance and gas cylinder.

Do not use a rusty or dented gas cylinder or cylinder with a damaged gas valve.

Do not fill the gas cylinder beyond 80% capacity.

Do not store gas cylinder indoors, or in any enclosed area.

Do not lay the gas cylinder down.

## Safe Operation

This barbecue becomes very hot during use, so:

- Keep young children away.
- When handling hot components, the use of protective gloves is recommended.
- Do not allow the flexible gas supply hose or any



# Safety Warnings

electrical cord to come in contact with any heated surface of the appliance.

DO NOT wear loose garments or sleeves when using the barbecue.

Do not leave your barbecue unattended whilst in use.

Do not use plastic or glass utensils on the barbecue.

Do not operate barbecue in strong winds.

Do not move the appliance during use.

Do not allow children to operate this appliance.

Do not operate window roasting hoods in the rain.

Do not disconnect any gas fittings while the appliance is operating.

## Safe Lighting

Always leak-test with a solution of soapy water. Do not test for gas leaks with a naked flame.

Always fully open the roasting hood or remove the metal lid of the appliance before lighting.

Visually check burner flames to confirm lighting.

Do not lean over barbecue when lighting.

Do not use charcoal or any other solid fuel in this appliance.

## Safe Care and Maintenance

Keep your barbecue clean. In particular:

- After cooking turn barbecue to high for up to 10 minutes to burn off excess grease.
- Let the barbecue cool before replacing any lid or cover.
- Regularly empty and clean grease receptacle.
- Clean the appliance at least twice annually.
- Check main opening, throat and venturi to each burner and pilot flame tube regularly for insect nests (eg. wasp, ants or spiders). Nests are dangerous and must be cleaned out thoroughly.
- Do not use caustic based cleaning agents on the barbecue.

Check all gas hoses and line connections for damage, cuts or cracks each time the appliance is to be used.

Do not attempt to modify the appliance. Any modification to this appliance may be dangerous.

Do not attempt to dismantle or adjust control valves or regulator.

## If there is a fire

Most fires are caused by a build up of grease, or by an improper gas connection.

Ensure all people and pets are kept as far away as possible.

If you are able, turn the gas off at the cylinder or for piped installations, the on/off valve.

Use a fire extinguisher if possible. If water is the only fire retardant available, thoroughly soak the area around the appliance. When spraying water on the barbecue itself, do not use a strong jet of water, as this may cause splashing of burning grease, resulting in a further spreading of the fire. Rather spray lightly over the frame cooking surfaces to cool the appliance below ignition temperature.

## Caution: Electrical Warning

If your barbecue incorporates an electrical component, such as a rotisserie, then it must be electrically grounded in accordance with local codes. The electric cord must be equipped with a three-prong (grounding) plug for your protection against shock hazard and should be plugged directly into a properly grounded three-prong receptacle. Do not cut or remove the grounding prong from this plug. Keep any electrical supply cord and the fuel supply hose away from any heated surfaces.

If an external electrical source is utilised, this outdoor cooking appliance, when installed, must be electrically grounded in accordance with the local codes or, in the absence of local codes with the following:

USA: National Electrical Code, ANSI/NFPA 70

CAN: Canadian Electrical Code, CSA C22.1

AUS: Aust Standards Code AS:5601

### USA

Fuels used in gas or oil-fired appliances, and the products of combustion of such fuels, contain chemicals known to the state of California to cause cancer, birth defects and / or other reproductive harm. This warning is issued pursuant to the California Health & Safety Code Sec. 25249.6.

- Should the appliance go out for any reason, turn off all control knobs and the cylinder gas valve. Wait 5 minutes before attempting to relight the appliance.
- Some foods produce flammable fats and juices. Attend an operating barbecue at all times. Damage caused by fat & grease fires is not covered by warranty. If a grease or fat fire should occur, immediately turn off all control knobs and the gas cylinder valve until the fire is out. Remove all food from the appliance.
- A leak test must be carried out prior to using the appliance for the first time and whenever the gas cylinder is refilled or whenever the gas hose and regulator have been disconnected from the gas cylinder or appliance.

# Locating Your Barbecue

**Most importantly, this is an outdoor appliance. Ensure your barbecue is positioned safely away from anything that can catch fire.**

**Indoor Use Only:** Under no circumstances is this barbecue to be used indoors. This includes garages or any other enclosed area.

**Clearance From Combustibles:** Ensure your barbecue remains at a distance of at least 45 cm (18") from any combustible material such as wood, gyprock, paper and plants. Do not store combustible materials, gasoline or flammable liquids or vapours within 45 cm (18") of the barbecue.

**Adequate Ventilation:** Ensure there is adequate ventilation for both the barbecue and cylinder. This is required not only for proper combustion, but also to prevent gas build up.

**Firm Level Surface:** Use your barbecue only on a firm level surface. This barbecue is not designed for recreational vehicles, and shall not be installed on a boat or any marine craft.

**Protection From Weather:** Keep the barbecue protected from adverse weather, including rain and high winds. Polyvinyl covers are available that have been specially designed for this range of barbecues.

Allow clear access to the entire gas supply hose and regulator.

**Maintenance Access:** When your barbecue is installed, you should be able to access the gas supply line including the gas piping or hose, gas regulator, gas cylinder and any shut off valves.

**Partial Enclosures:** Many backyards have areas that are partially closed off, such as balconies and pergolas. In some cases, it is hard to decide whether these partially enclosed areas should be classified as indoor areas, particularly in terms of permanent (non-closable) ventilation. The gas safety authorities have agreed on the definition of partial enclosures below.

## Partial Enclosures (Australia Only)

This appliance shall only be used in an above ground, open air situation with natural ventilation, without stagnant areas, where gas leakage and products of combustion are rapidly dispersed by wind and natural convection. Any enclosure in which the appliance is used shall comply with one of the following:

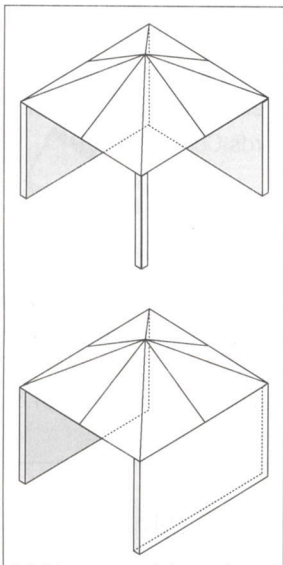

Within a partial enclosure that includes an overhead cover and no more than two walls.

A common example is an outdoor gazebo.

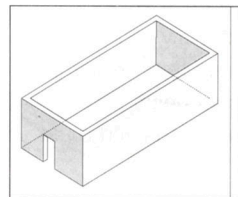

Any enclosure with walls on all sides, but at least one permanent opening at ground level, and no overhead cover.

A common example is an enclosed back yard. Typically, the walls are less than 3m high. If they are higher, there is a danger of gas build up.

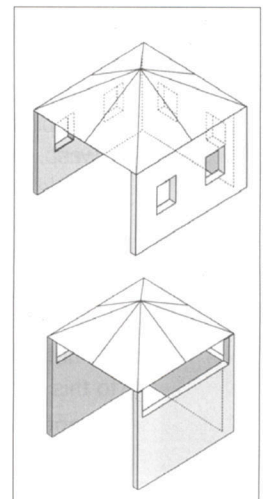

The barbecue may be within a partial enclosure that includes an overhead cover and more than two walls, the following shall apply:

- At least 25% of the total wall area is completely open; and
- at least 30% of the remaining wall area is open and unrestricted.

In the case of balconies, at least 20% of the total of the side, back and front wall areas shall be and remain open and unrestricted.

# Installation Options

**Before proceeding, you need to establish the gas type which your barbecue will run on, and the style of installation you need.**

## Natural Gas or LPG/Propane

Before beginning installation or assembly, check that the gas type which the barbecue is designed for is correct for the gas available to you. In most countries the choices are natural gas or LPG/propane. You will find the gas type label on the side of your barbecue. If your barbecue uses the incorrect gas type, or if you are unsure, consult your dealer before going any further. Using the wrong type of gas for a barbecue is extremely dangerous.

**Natural Gas Conversion:** Most newly purchased barbecues are made for LPG/propane. A natural gas conversion kit is available to allow your barbecue to run on natural gas.

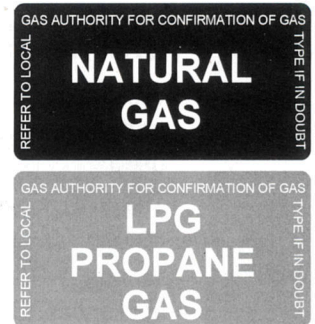

## Fixed (Piped) Installations

**Piped Natural Gas:** Although installation costs are higher, this is typically the least expensive way to run your barbecue. Natural gas is delivered via pipeline to a gas meter near the perimeter of your home. From the gas meter, gas is taken by a further series of pipes to each appliance that uses natural gas.

**Piped LPG/Propane:** Some properties do not have natural gas available to them. In these cases, the local gas supply company may be able to provide two 45 Kg (100 lb) cylinders permanently installed on the outside of your home. These are refilled for you by the gas company based on your usage patterns. Copper pipe is then run from these cylinders to each appliance that uses LPG/propane.

There are two methods of connecting the gas to your barbecue, both of which require the services of a licensed gas fitter:

- For built in (ie non-mobile) installations, the barbecue inlet can be connected directly to copper piping. From here the barbecue cannot be moved.
- The copper piping can terminate in a "bayonet point" on a wall or other structure. A special hose and terminator allows the barbecue to be connected and disconnected from the bayonet point safely and conveniently. This allows the barbecue to be moved if necessary.

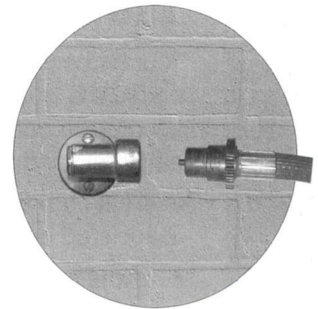

## Portable LPG/Propane Cylinder

The most flexible arrangement is a portable LPG/propane gas cylinder attached by a special hose and regulator to your barbecue. Although the cylinder needs to be refilled or exchanged when empty, this installation has the advantage of being more mobile, and not requiring the services of a licensed gas fitter.

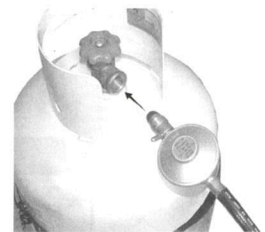

## Built in or Mobile Trolley/Cart

Whatever gas option you choose, your barbecue can be mounted on a mobile trolley/cart, or it can be permanently built-in. Details of built-in requirements are on the next two pages. Details for the assembly of your mobile trolley or cart is included with its separate packaging.

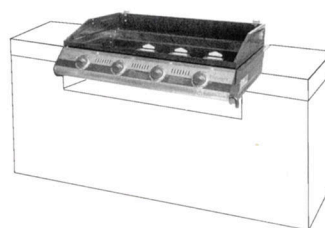

# For Built-In Units Only

The Discovery series of barbecues comes in both trolley-mounted and built-in models. These two pages contain information relating to setting up the built-in model only.

## General Requirements

We recommend that this installation be done in a masonry structure and carried out by a professional tradesperson. Other non-combustible material such as Hardiplank, Villaboard with metal studs may also be used.

This appliance must not be installed under or on any combustible material. Minimum clearance from combustible construction materials to all sides of the appliance is 450mm (18").

Warning: Contact your local municipality for any building codes regulating the installation of outdoor barbecue appliances. Outdoor installations must conform to local codes or, in the absence of local codes, with:

- USA: National Fuel Gas Code, ANSI Z223.1/NFPA 54
- CAN: B149.1 Natural Gas & Propane Installation Code.
- AUST: Australian Standards Code AS: 5601

as well as the requirements of any local council, gas, electricity authority or other statutory regulation.















## The Barbecue Cavity

Your barbecue has been designed to sit into a cavity or cutout rather than be placed directly onto a flat surface. It is important that the dimensions of the cavity conform exactly to those listed below. This will ensure the barbecue sits correctly in the cavity, and that the barbecue has sufficient ventilation to operate efficiently and safely. It also allows room for any roasting hood to open freely.

In creating the cavity, you should ensure that you have convenient access to the gas connection point and associated hardware:

- If the gas for your barbecue is supplied by a portable gas bottle, you will need access to the gas connection point, the gas hose and the gas cylinder at all times.
- If the gas for your barbecue is supplied by a fixed piped gas supply (either natural gas or 45kg LPG cylinders), you will need access to the gas connection point, the piping and the shutoff valve.

## Built-in Cavity Dimensions

	Width
x 2  	20 5/8" 523mm
x 3   	27 1/8" 690mm
x 4    	33 1/4" 846mm
x 5     	39 1/2" 1003mm

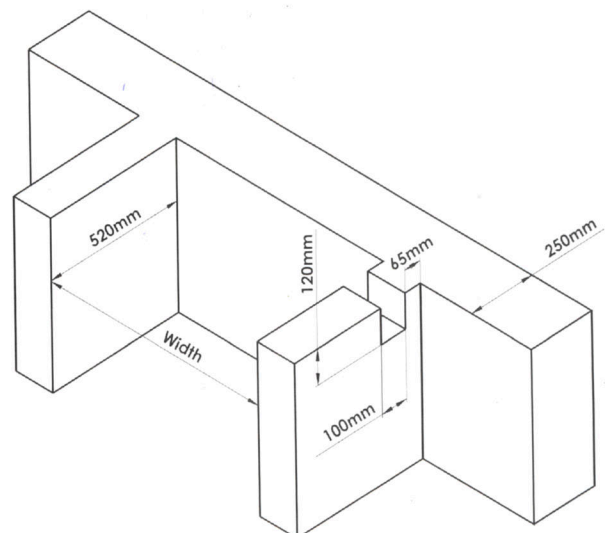

# For Built-In Units Only

## The Cylinder Compartment

If the gas for your barbecue is to be supplied by a portable LPG/propane cylinder, you will need to ensure that adequate provision is made to house the cylinder safely. The following must be adhered to:

**Keep out of heat:** The cylinder and hose must be sheltered from the sun's direct heat. The flexible PVC hose assembly supplied must not be exposed to temperatures in excess of 60°C (140°F). DO NOT allow the hose to come in contact with the hot surface of the barbecue body.

**Keep cylinder upright:** The cylinder must be housed securely. It must remain upright at all times. It can be either attached to a firm vertical wall by a cylinder bracket, or stored on a firm level base.

**Requirements for cylinder base:** If the cylinder is to be stored on a flat base, the base must be made from non-combustible material. Soil or grass is not an appropriate surface. Ensure there is adequate drainage, and that water cannot collect around the cylinder.

**Requirements for cylinder compartment:** Where the cylinder is to be kept inside an enclosure, you must ensure there is 200 square centimetres of open ventilation at each of the top and the bottom of the enclosure, for each cylinder stored in it. This prevents leaking gas from building up in a confined space. Gas vapour is highly explosive and can cause serious bodily injury or damage to property if allowed to accumulate in a confined space and ignited.

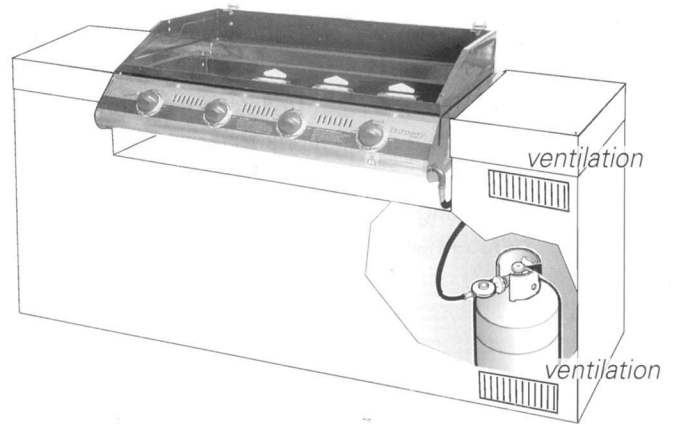

## Attach The Brackets

Screw the built-in brackets to the side of the barbecue as shown. These brackets are designed to rest on the sides of the brickwork. This performs two important functions:

- The ventilation slots in the brackets allow air to pass between the sides of the barbecue and the brickwork. This prevents the barbecue from overheating and provides air to allow the barbecue to burn gas correctly.
- The brackets allow the barbecue body to be lifted above the flat surface underneath. This allows the grease tray to slide out freely, and for combustion air to enter from underneath.

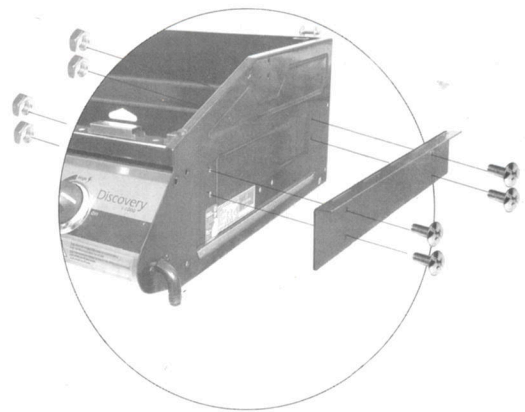

## Lower The Barbecue Into Position

When lowering the barbecue onto the brickwork, do not push the barbecue back as far as it will go. Ensure there is at least 50 mm clearance behind the rear of the barbecue to allow for proper ventilation, and to allow any roasting hood to open freely.

Note in the illustration how there is an air gap between the side of the barbecue body and the wall of the cavity. It is important for the proper operation of the gas barbecue that air can flow freely up past the side of the barbecue and through the air slots on the brackets.





# Assembly Instructions

## Before You Start

Note the tools you will need before you begin.

Remove any packaging material or protective plastic from components.

Check for damaged or missing parts, and consult your retailer if necessary.

Mobile carts and trolleys are optional. You should follow the separate instructions that came with the trolley before assembling and installing your barbecue.



*adjustable spanner/  
wrench*



*Phillips Head  
Screwdriver*

## Check The Cross Lighting Channels

The cross lighting channels should already be in place. If they are not, or if they moved during shipping, they need to be replaced as follows: place each cross-lighting channel onto the back support panel. The keyed tabs on the bottom of each cross-light channel fits into the slots on the burner support rail. The cross lighting channels are required for all models.

## Check The Burners

The burners should already be fitted to the barbecue. If they are not, or if they moved during shipping, they need to be replaced as follows:

Remove the retaining clip from the burners. Fit the burners, open end first, over the stem of the control valves at the front of the barbecue. Lower the other end of the burner so the lug locates into the corresponding hole at the rear of the barbecue.

Replace the retaining clips into the burner lugs so the burners stay in position. You need to do this from behind the barbecue, underneath the back panel.

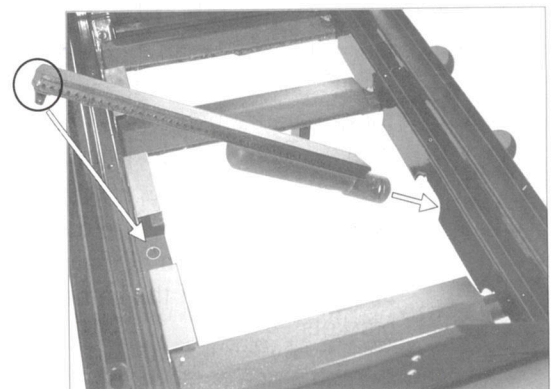
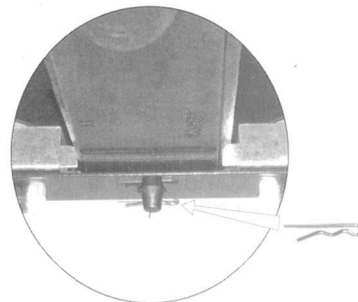

# Assembly Instructions

## Fit The Vaporizers

The Vaporizers are designed to vapourise fats and juices from your food. The Vaporizers reduce flare-ups and help to add that great barbecue flavour.

To install the Vaporizer(s), remove all plastic and/or cardboard packaging material and place the Vaporizer into position on the right hand side of the barbecue. The Vaporizers must be fitted to the same side of the barbecue as the grill. They will not work if fitted under the solid plate.

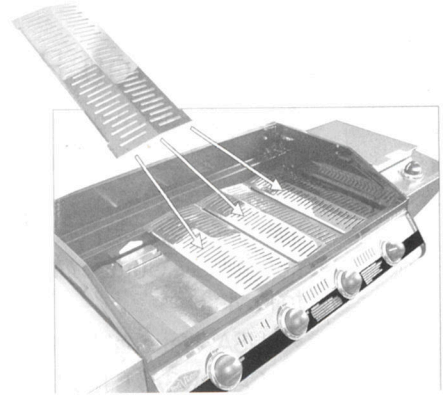

*Note: Vaporizer grid style may vary between barbecues.*

## Fit The Cooking Plates And Grills

We recommend fitting the solid plate to the left-hand side of the barbecue frame (with the drain hole to the extreme left). The grills can be fitted to any side of the barbecue frame. **IMPORTANT:** the grills must always be positioned over the Vaporizers.

This appliance is designed to ventilate air through the barbecue while it is operating. Do not fit additional cooking plates to the top of the barbecue. Doing so will prevent the unit from ventilating and will cause serious damage to the barbecue.

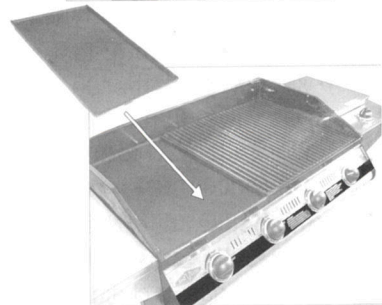
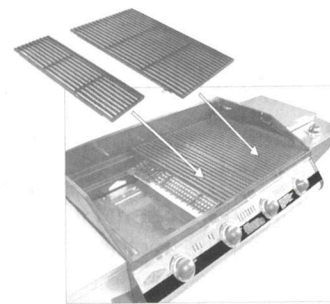

## Set Up The Grease Tray

Assemble the grease tray as shown in the diagram below. Attach the waste tray brackets to the grease tray using the screws, nuts and washers provided. Slide the smaller waste tray into place.

You may line the grease tray with a sheet of aluminium foil if you wish. Remember to place a hole in the centre so the grease can flow into the smaller waste tray.

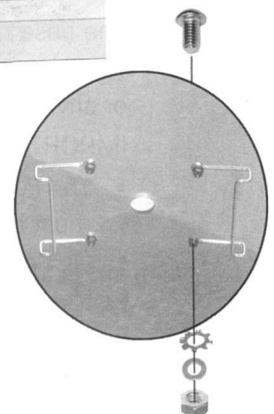
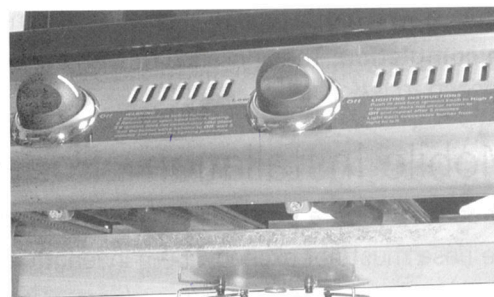

# Connection to Barbecue & Gas Supply

## Before You Begin

Check the gas type label as described in the section titled "The Gas Supply".

Ensure all considerations such as clearances from combustibles listed in the "Locating Your Barbecue" section are adhered to.

**Warning:** Contact your local municipality for any building codes regulating the installation of outdoor barbecue appliances. Outdoor installations must conform to local codes or, in the absence of local codes, with the following:

- USA: National Fuel Gas Code, ANSI Z223.1/NFPA 54
- CAN: CGA: B149.1 Natural Gas & Propane Installation Code.
- AUST/NZ: Australian Standards Code AS: 5601

as well as the requirements of any local council, gas, electricity authority or other statutory regulation.

Flexible PVC hose assemblies supplied must not be exposed to temperatures in excess of 60°C (140°F). DO NOT expose to the sun's direct heat and DO NOT allow the hose to come in contact with the hot surface of the barbecue body.

## Fixed Installation - Piped Natural Gas or LPG/Propane

**Fixed installations should be carried out by a qualified gas fitter. BeefEater barbecues are designed as low-pressure appliances.**

**Gas connection:** Fit the hose directly to the barbecue inlet located on the right side of the appliance using either hard plumbing, or a flexible hose connected to a bayonet point. Refer to AS 5601 or your local installation code for pipe sizing details. Secure all joints spanner (wrench) tight but do not over-tighten.

**Pressure testing:** Test gas pressure by removing the last burner from the left hand side of the barbecue and attaching a hose and pressure gauge to the end of the gas valve. Turn on 2 burners and check the pressure. Inlet pressure should be 1.00 kPa / 4.0" WC for natural gas, or 2.75 kPa / 11" WC for LPG/propane. The barbecue appliance must be isolated from the gas supply piping system by closing its manual shutoff valve during any pressure testing of the gas supply piping system.

**Australia only:** For mobile trolley installations that use flexible hosing to connect to natural gas, a chain or similar restraining device must be fitted to prevent strain on the gas supply line. One end of the chain should attach to the barbecue; the other end should attach to a fixed structural point close to where the hose connects to the gas piping. The chain must be at least 30% shorter than the gas supply line. In this way, if the barbecue is accidentally moved, the chain stops the barbecue from stretching the hose.

**On completion:** The appliance must be tested for safe and proper operation on completion of installation. Proceed to leak test.

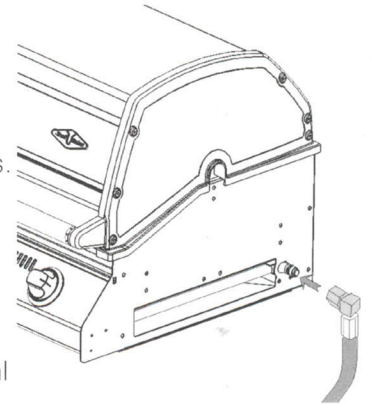

## Mobile Installation - Portable LPG

**When installing a portable LPG cylinder, the following must be observed:**

The hose must not exceed 1.50m in length.

Gas cylinders must be stored outdoors, out of reach of children, and must not be stored in a building, garage or any other enclosed area.

**IMPORTANT:**

- The cylinder supply system must be arranged for vapour withdrawal. This normally means the cylinder must be upright.
- Do not store a spare LPG/propane cylinder under or near this appliance.
- Never fill the cylinder beyond 80% full.

If these directions are not followed exactly, a fire causing death or serious injury may occur.

- Only one gas cylinder may be attached to the appliance at any one time.

# Connection to Barbecue & Gas Supply

- Minimum LPG/propane cylinder capacity for use with this appliance is 4kg / 9 lb. Maximum cylinder capacity is 9 kg / 20 lb.
- The gas cylinder used must incorporate a safety collar to protect the valve assembly. Do not use a rusty or dented gas cylinder or cylinder with a damaged gas valve.
- **North America Only:** The Gas cylinder must be constructed and marked in accordance with specifications for LP Gas Cylinders of the U.S. Dept. of Transportation (DOT) or the National Standard of Canada, CAN/CSA - B339, Cylinders, Spheres or Tubes for the transportation of dangerous goods.
- **North America Only:** The gas cylinder must be provided with a listed overfilling prevention device. The cylinder must be provided with a cylinder connection device compatible with the connection for outdoor cooking appliances. Ensure the cylinder valve and barbecue control knobs are all off. Remove the protective cap from the cylinder if present.

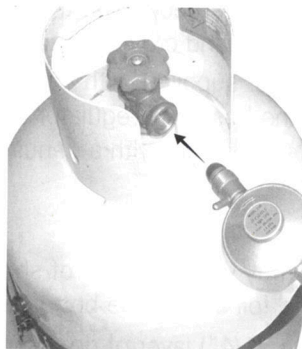

*Regulators which fit inside the mouth of the cylinder valve are tightened anti-clockwise.*



*Regulators which screw onto the outside thread of the cylinder valve are tightened by turning clockwise.*

**Gas connection:** Connect the hose to the gas inlet on the right hand side of the barbecue. Tighten with a spanner (wrench) but do not over-tighten.

Connect the regulator end of the hose to the gas cylinder as shown. Ensure the hose does not twist or kink.

**On completion:** The appliance must be tested for safe and proper operation on completion of installation. Proceed to leak test.

## Leak Test

**The gas leak testing procedure should be conducted every time a gas cylinder is refilled and reconnected to the appliance, or after any new gas connection is made. Never use a naked flame to check for gas leaks.**

In a small container, mix up a solution of water and detergent or soap. Mix the solution well.

Make sure that the gas supply valve on the gas cylinder or the shut off valve on the supply line is turned on.

Make sure that the gas control valves on the appliance are all turned off.

Using a brush or spray bottle apply the solution to the gas line and each joint in the gas line, including the hose and regulator.

Bubbling of the solution will indicate that there is a leak present.

Re-tighten or re-seal any joints that are leaking.

If a leak persists contact your distributor or the manufacturer for assistance.

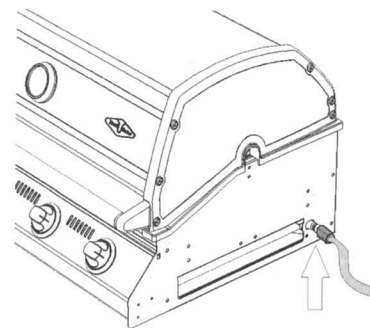

## Disconnecting The Gas Supply

If you need to disconnect the gas supply for any reason, always ensure that all gas controls on the appliance and on the cylinder are off before disconnecting or removing the gas cylinder. Do not smoke or use a naked flame near the appliance or gas cylinder while connecting or disconnecting the gas line.

If installed in an enclosure, remove the gas cylinder from the enclosure before disconnecting the gas line from the appliance. Tighten all connections before placing the gas cylinder back in its enclosure.

# Using Your Barbecue

## Before You Light The Barbecue

Perform the following checks

- Make sure all gas connections are tight and leak tested. Gas regulators that are fitted with a hand-tightening wheel should be checked to ensure that the connection is secure.
- Check the control knobs are in the off position and that the gas supply is turned on
- Ensure the hood of the barbecue and the lid of any side burner are up. If the lids are left down, gases can build up inside the hood and create a dangerous situation.
- The hose and regulator supplied with this barbecue must be used at all times whilst operating this barbecue. Inspect the hose and regulator for cracks or any sign of wear or damage. If there is excessive abrasion or wear, replace only with a genuine BeefEater hose and regulator.

## Grease Tray

Neatly line the grease tray with a couple of sheets of aluminium foil to aid in clean up. Cut the foil to shape and make sure that the foil sits on the bottom of the tray

Fill the tray with a 6mm (1/4") layer of dry sand or other non-combustible absorbent material to absorb grease. Change the foil and absorbent material regularly to reduce the likelihood of a grease tray fire

## Lighting The Barbecue

Your barbecue is equipped with a safety feature that prevents the burners from being accidentally turned on. You must push the knob inwards to disengage the lock and allow the knob to rotate.

1. Push in and hold the far right control knob down while turning slowly in a counter-clockwise direction until the starter mechanism engages at the two o'clock position. At this time the gas will start to flow.
2. Hold the control knob in while continuing to turn the knob toward the High or twelve o'clock position.
3. The starter mechanism will click and the main burner will now light. Continue turning the knob slowly until it rests in the twelve o'clock position.

If the burner is alight, release the knob.

The other burners can now be lit successively, from right to left

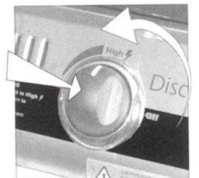

## If The Burner Does Not Light

Keep the control knob pushed in and turn the control knob in a clockwise direction to return to the Off position. Wait 5 minutes for the gas to disperse and then repeat steps 1-3. If you cannot light the burners, call your retailer before proceeding.

## Manual Lighting

Press and turn the right hand control knob anti-clockwise to the High position, then light the right hand burner immediately through the gap between the front of the drip tray and the barbecue body.

Failure to follow these lighting procedures exactly could lead to a hazardous situation.



## Check Proper Burner Operation

Following operating instructions light each burner and check for a clear blue flame with just a tip of yellow. Excess yellow tipping can be adjusted using the screw on the side of the burner. Turn the screw in an anti-clockwise rotation to remove the yellow. If you are unable to achieve correct operation, consult your dealer.



# Using Your Barbecue

## Controlling The Burners

The control knob can now be turned to the desired heat setting, Low, Medium or High. The control knob does not need to be pushed in while selecting the heat setting.

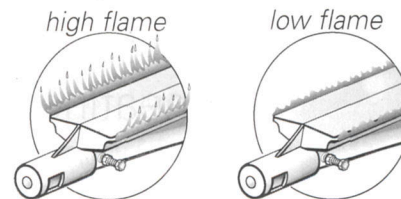

## Preparing The Plates And Grills

Your barbecue has heavy duty enamelled Cast Iron plate and grill. Enamel is a hard, non-rusting surface which will ensure the long life of your cooking surface.

The plate and grill are ready to use, but it is recommended to wash them with warm soapy water and a soft cloth, and rinse before use. To ensure the longevity of the enamel surface on the Cast Iron plate and grill it is strongly advised to avoid impact with other metal parts and sharp utensils.

## To Turn Off The Burner

Push in and hold the control knob while turning in a clockwise direction until the off position is reached. Failure to follow these shutdown/turnoff procedures exactly could lead to a hazardous situation.



## After Use

It is a good idea to leave the barbecue on for about 10 minutes after you have finished cooking. This helps to burn away any excess food residues and oil, and makes cleaning easier.

1. Be sure to turn off all control knobs and the gas supply.
2. Allow the barbecue to cool.
3. Clean the drip tray and cooking surfaces. Clean any food spills from the side burner, if one is installed.
4. Lower the hood and side burner lid.

The gas cylinder supply valve must be turned off when the appliance is not in use.

## Direct Cooking Method

Commonly used for traditional barbecuing. Place food over the lit grill section. Excess flaring may occur so care must be taken while cooking. Check inside the roasting hood regularly. The direct cooking method is recommended for steaks, chops, sausages, and hamburgers.

## Indirect Cooking

This method of cooking applies only if you have a roasting hood.

Indirect cooking involves little or no heat directly underneath the food. Instead, the food is placed on the grill, the burners below the food are turned off, and burners on either side are used. The hood is closed to trap heat and moisture. With this method, heat circulates around the food, cooking by convection. By trapping the vapour inside your "outdoor oven," the cooking vapour will fall back on the food on all sides, not just from underneath. The food cooks more evenly, and stays moist in the process.

Indirect cooking is similar to using a conventional oven and is recommended for rotisserie cooking, roasts, poultry, casseroles, vegetables and whole fish.

When cooking a roast, it is a good idea to use a roast holder and baking dish. Always use a baking dish with a depth greater than 35mm. Shallower trays may fill quickly and overflow, which may cause a fat fire.

# Getting The Most From Your Barbecue

## Preheating Your Barbecue

Like an oven, preheating your barbecue before cooking produces better results. Because your hood retains heat so efficiently, preheating your barbecue is quicker with the hood down.

Turn the outside two burners to high. Close the hood, and allow to preheat for about 8 minutes. Then reduce the burner settings to achieve and maintain the required temperature, by following these guidelines.

## Maintaining The Right Cooking Temperature

**Do not exceed the temperature warning on the temperature gauge. Operating the barbecue above this temperature may cause damage to the appliance. Your hood is designed to keep the heat in, so requires constant monitoring.**

These two charts tell you how hot and how long to cook various types of meat, and the approximate burner settings to help you achieve these results.

Two burner	Both burners slightly below medium
Three burner	Middle burner off Two outside burners to medium
Four burner	Two inside burners off Two outside burners to medium
Five burner	Three inside burners off One outside burner to high Other outside burner to medium

Type of Meat	Cooking Temperature	Approximate Cooking Times	
Beef	180°C / 355°F	45-55 min per kg	20-25 min per lb
Lamb	180°C / 355°F	45-55 min per kg	20-25 min per lb
Pork	170°C / 340°F	55-60 min per kg	25-30 min per lb
Veal	160°C / 320°F	40-50 min per kg	18-23 min per lb
Poultry	180°C / 355°F	40-50 min per kg	18-23 min per lb
Seafood	150°C / 300°F	20-30 min per kg	9-15 min per lb

You may find it useful to purchase a meat thermometer to help take the guess work out of cooking.

Meats such as beef, lamb, veal and pork should be about 70°C / 160°F when medium. Chicken and Turkey should be 85-90°C / 185-195°F.

Do not use more than 2 burners on high at any one time. As a guide, for a 4 burner barbecue in moderate weather:

- Two burners on low produces 150°C / 300°F
- Two burners on medium produces 195°C / 385°F
- Two burners on high produces 240°C / 460°F

During cold or windy conditions, more heat is required.

Finally, resist the temptation to keep opening the hood while cooking. This will help to maintain a constant temperature, and minimise cooking time.

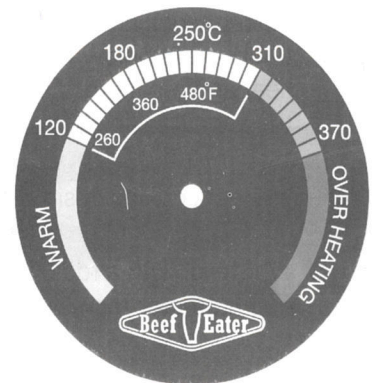

*Do not allow your barbecue to overheat, as this may damage some components.*

# Cleaning And Storing Your Barbecue

## Cleaning Vitreous Enamel Surfaces and Barbecue Control Panel

Although porcelain enamel will keep its lustrous finish even under adverse conditions, it still needs regular cleaning. After the appliance has been used, wash down the surfaces with hot soapy water. Caustic cleaners should be avoided. For barbecues near the ocean or salt-water environment, more frequent cleaning and servicing should be conducted. Wash regularly, rinse and then dry before covering. (In a salt water or marine environment, more rapid deterioration can be expected which is not covered by warranty).

## Cleaning Plates and Grills

Many food acids, marinades, juices and sauces contain highly acidic elements that will slowly attack the surface of the plates and grills if not removed after cooking.

- After use, remove all solid material from the cooking surfaces using a brass bristle brush or plastic scourer. Brushes specifically designed for this purpose can be purchased from your BeefEater retailer. Wipe off remaining residue with a paper towel.
- Gently wash the surface of the grills with a soft sponge and a solution of hot water and a mild dishwashing liquid. Do not use highly caustic, harsh or abrasive chemical cleaners to clean the cooking grills. Always check the manufacturer's recommendations for the cleaner prior to use.
- Coat the grills with a layer of cooking oil. This will help protect the surfaces between uses.
- For porcelain enamel coated cooking surfaces, do not use any metal tools to clean the surface. Use only a brass bristle wire brush to remove hard deposits.

Do not clean the cooking surfaces in a dishwashing machine. For hard deposits and heavy grease, do not use steel wool or metal scrapers. Use concentrated detergent or domestic cleaning powders.

## Cleaning The Drip Tray

Never remove the grease tray while the barbecue is hot. Always remove and clean the grease tray after the unit has cooled down.

Replace aluminium foil on main drip tray (if used) and clean both waste trays at regular intervals to prevent grease build-up, which could result in a grease fire and void the barbecue warranty.

## Cleaning The Burners

- Check main opening, throat and venturi to each burner regularly for insect nests (eg. wasp, ants or spiders). Nests are dangerous and must be cleaned out thoroughly.
- Remove burners periodically and scrub clean with soapy water and a wire brush making sure that the ports are free of obstructions.

Replace burners in the correct position and dry by lighting each one to avoid subsequent corrosion.

A clogged burner can lead to a fire beneath the grill.



## Storing Your Barbecue

When storing barbecue for extended periods, be certain all controls and cylinder valves are turned off.

If storing the barbecue indoors remove gas cylinder and store the cylinder in a ventilated area outdoors.

Gas cylinders must be stored outdoors, out of reach of children and must not be stored in a building, garage or any other enclosed area.

The barbecue should be covered when not in use. eg a polyester or vinyl barbecue cover.

Frequently check and tighten all nuts and bolts on the barbecue and trolley

The gas cylinder supply valve must be turned off when the appliance is not in use.



**Note:** For storage and cylinder exchange, disconnect hose at the cylinder only, do not disconnect hose from appliance.

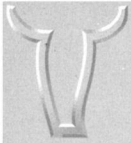

# Service And Maintenance

This appliance should be checked and serviced by an authorised service person every 2 years to ensure the appliance remains in a safe operating condition. (These services are not covered by warranty). Replacement parts are available from your authorised BeefEater Dealer

	Each use	Every 6 months	By authorised service agent every 2 years
Check all hoses for cracks and leaks	✓		
Check that all gas connections are tight	✓		
Clean entire barbecue thoroughly		✓	
Check and tighten all bolts on barbecue and trolley		✓	
Clean and inspect Vaporizers		✓	
Clean and inspect barbecue burners		✓	
Clean and inspect gas injectors and control valves			✓
Check working of ignition system			✓

## Trouble Shooting Guide

Problem	Cause	Check
Barbecue will not light	Ignition system not working	Check to see visible spark at starter probe - if no spark is present when control knob is turned then the unit may need to be serviced or replaced. Contact your BeefEater dealer. Check that there is a visible flame coming from the pilot ignition tube. Check that the pilot ignition tube is not blocked by spider webs or insect nests.
	Turning on gas control too quickly	Allow at least 5 seconds for gas to flow through burner before ignition
	No gas flow	Check that valve on gas cylinder is turned on. Check that burner ports are free of obstructions. Check that all gas injectors are clean and free of obstructions
	Burners not assembled correctly	Check that burners are correctly positioned in the barbecue frame.
	Burner ports or throat blocked	Check that the burner ports are not blocked by spider webs or insect nests. Clean out as required
Barbecue lights but goes out soon after starting	Fuel supply turned off	Turn on gas valve at cylinder
	Gas cylinder low or empty	Refill cylinder with gas
	Kink in gas hose	Check that the gas line is not kinked or twisted
	Wind or breeze affecting operation	Ensure that the appliance is located out of the way of wind
Burners will not cross light from one to the other		Check that cross light channel is in place. Check that burner ports are free of obstructions.
Low flame level or low heat output		Check you are running on correct gas. Check gas injector size is correct

## Gas Consumption

	BTU/hr	MJ/hr	kW	g/hr
2 burner	30 400	32	8.9	640
3 burner	45 600	48	13.3	960
4 burner	60 800	64	17.8	1,280
5 burner	76 000	80	22.2	1,600



# Warranty

Should any part fail due to defective workmanship or faulty materials within the specified period from the date of purchase, BeefEater or its distributor will repair or, (at distributors option), replace the defective part free of charge.

## LP / Propane Gas Cylinder

The cylinder manufacturer is responsible for the materials, workmanship and performance of the gas cylinder. Contact your dealer or the cylinder manufacturer in respect of all warranty claims or service.

## Warranty Administration

In Australia, warranty is administered by BeefEater Barbecues. In other countries, contact your authorised BeefEater retailer for details of your BeefEater distributor.

To ensure speedy processing of your warranty service claim, ensure that you record all specific details about your appliance in the space provided. Keep this information handy for future reference.

## NOT COVERED

### Storage

Exposure of the barbecue appliance to the elements should be minimised. Once the unit has cooled and is cleaned, store the barbecue under cover. Polyester/Vinyl barbecue covers are an optional accessory that will ensure years of trouble free operation.

This warranty does not cover the purchaser or any other person for damage, malfunction or loss due to the following:

- Lack of maintenance, abuse, neglect, misuse, accident or improper installation of this appliance.
- Scratches, dents, corrosion or discolouring caused by heat, abrasive or chemical cleaners or chipping on porcelain parts.
- Corrosion or damage caused by exposure to the elements, grease fires, insects, weather or hail.

Note: Barbecues must be covered when

not in use.

- Cleaning and normal wear and tear. Service calls of this nature are chargeable.
- Rusting of cast iron plates, grills and burners.

Note: Rust should be removed by a scrub pad and the surface coated with cooking oil. See owners manual – Caring for cast iron cooking surfaces. Cooktops must be covered when not in use.

- Commercial use of the barbecue.
- Unauthorised repairs during the warranty period
- Removal or re-installation costs.
- Cracks and weathering of timber parts caused by exposure to the elements or damage by weather, heat, insects, chemicals or foods acids or juices.
- Glass – All glass components are covered by a 30 day – first up failure warranty. All claims for glass breakage must be made within 30 days from the date of purchase. Claims for breakage after this period will not be recognised.

## Conditions of Warranty

1. The appliance is delivered to the BeefEater distributor's service department or authorised service agent and freight charges both ways are paid by the owner. No liability is accepted for loss or damage during transit. The appliance is installed by a qualified person and operated and maintained in accordance with the instructions supplied. Repairs or service must be carried out by an authorised person. Installation must conform to the applicable Gas, Electrical and Building standards laid down by the local codes for your country or region.
2. No alterations or repairs have been carried out without obtaining the distributors prior consent. Such repair or any replacement does not extend the warranty period.
3. Proof of purchase together with the

warranty card must be provided to verify purchase date and establish the warranty period. Only the original purchaser is covered under this warranty.

4. The warranty period is calculated from the date of purchase only.
  5. Where this warranty is inconsistent with any state laws, the statutory rights of the purchaser shall prevail.
- Parts installed from other manufacturers' products will void this warranty.

Warranty Terms	
Barbecue Frame	5 years
Cast Iron Burners	2 years
Cast Iron Cooktops	2 years
Valves	2 years
Ignition System	2 year
Vaporizer Grids & Reflectors	1 year
All other parts	1 year
Roasting Hoods	
Body	5 years
Cast Alloy Parts	5 years
Glass (all claims for breakage must be made within 30 days of purchase)	
All other parts	1 year
Side Burners	
Body	1 year
Burner	1 year
Cast Alloy Parts	1 year
All other parts	1 year
Trolleys	
Galvanised Steel Parts	1 year
Timber Parts	1 year
All other parts	1 year

## SERVICE ASSISTANCE

To assist you when contacting your after sales service contact to arrange a service call please complete the following details and have them ready when you call. You do not need to register your warranty. However, you must retain your receipt or proof of purchase. When claiming warranty for this appliance you must provide a copy of your proof of purchase receipt. No claims for warranty will be accepted without proof of purchase.

Model number

Serial number

Retailer purchased from

Date of purchase

Type of Gas

LPG

Natural Gas

Our goods come with guarantees that cannot be excluded under the Australian Consumer Law. You are entitled to a replacement or refund for a major failure and for compensation for any other reasonably foreseeable loss or damage. You are also entitled to have the goods repaired or replaced if the goods fail to be of acceptable quality and the failure does not amount to a major failure



# Spare Parts - Continued

Index	Description	3 Burners	4 Burners	5 Burners
1	Hood top	DSI2060-3*	DSI2060-4*	DSI2060-5*
2	Hood liner (in SS BBQ only)	DSI22243-3*	DSI22243-4*	DSI22243-5*
3	Hood Back top	DSI2096-3*	DSI2096-4*	DSI2096-5*
4	Hood Back lower	DSI2071-3*	DSI2071-4*	DSI2071-5*
5	Hood Side screw	DR04-0011	DR04-0012	DR04-0013
6	Hinge set	DSI2070C	DSI2070C	DSI2070C
7	RHS hood endcap	DSI2062R*	DSI2062R*	DSI2062R*
8	Warning rack	DSI2006-3	DSI2006-4	DSI2006-5
9	Thermometer	DR09-0011	DR09-0011	DR09-0011
10	Beefeater Badge	060509	060509	060509
11	Hood Top-Glass Rail	DSI2066-3	DSI2066-4	DSI2066-5
12	Glass	DR09-0012-3	DR09-0013-4	DR09-0014-5
13	LHS hood endcap	DSI2062L*	DSI2062L*	DSI2062L*
14	Hood under-Glass trim	DR01-0011-3	DR01-0011-4	DR01-0011-5
15	Hod Bottom Front	DR01-0012-3*	DR01-0012-4*	DR01-0012-5*
16	Hood handle	DSI2068-3	DSI2068-4	DSI2068-5
17	handle spacer	DSI2089	DSI2089	DSI2089
18	Vaporizer	060554	060554	060554
19	Cast iron burner	94701	94701	94701
	Sheetmetal StainlessS burner	94721	94721	94721
20	Crossfire clips	DSI2028	DSI2028	DSI2028
	Cast iron plate-160mm (6 inches)		(94106) Optional	
21	Cast iron plate-320mm (13 inches)	94113		94113
	Cast iron plate-400mm (16 inches)		94125	
	Cast iron grill-160mm (6 inches)		(94006) Optional	
22	Cast iron grill-320mm (13 inches)	94013		94013
	Cast iron grill-400mm (16 inches)		94135	
23	Knob	060542*	060542*	060542*
24	Bezel	060514*	060514*	060514*
25	Valve no ignition	040148	040148	040148
26	valve w ignition	040147	040147	040147
27	Manifold assembly	DR09-0013-3*	DR09-0013-4*	DR09-0013-4*
28	Nut-n-tail fitting (EU Only)	DSI2038	DSI2038	DSI2038
29	Warning rack bracket	DSI2016	DSI2016	DSI2016
30	Fascia	DR02-0011-3*	DR02-0011-4*	DR02-0011-5*
31	Fat tray	DR04-0012-3	DR04-0012-4	DR04-0012-5
32	Retention clips grease collector	DSI2027	DSI2027	DSI2027
33	Fat collector	DSI2024	DSI2024	DSI2024
35	Instruction Book	DISBBQINS_AU	DISBBQINS_AU	DISBBQINS_AU
36	Vinyl Cover	94402-3	94402-4	94402-5
37	Cook Book for Discovery	BBQ_BOOK	BBQ_BOOK	BBQ_BOOK

\* For Discovery 'Plus' use "P", for Discovery Stainless Steel use "S"

## Barbecue Dimensions

Dimension A		
x 2		19 3/8" 493mm
x 3		26" 660mm
x 4		32 1/8" 816mm
x 5		38 1/4" 973mm

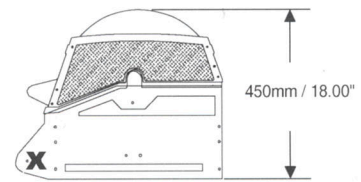
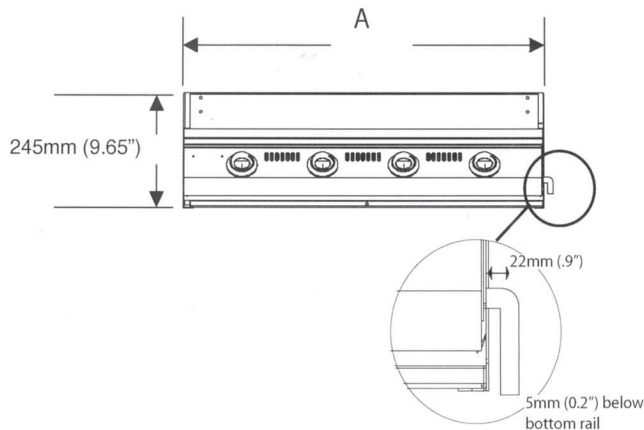

Gas connection point 45 mm from front of barbecue fascia

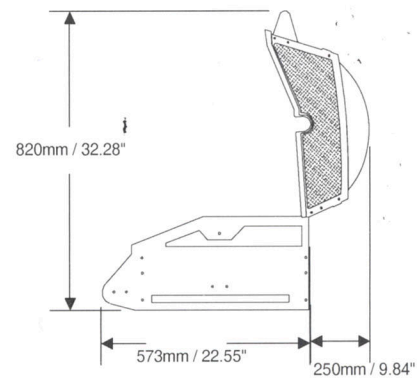



## Accessories Available

Your retailer can advise on the range of BeefEater accessories available to help you take full advantage of the barbecue cooking opportunities available with your roasting hood.



*Apron and Mitt Set - handle baking dishes and other hot items safely and with confidence*



*Poly Cover - protect your investment from the weather. Designed to fit BeefEater barbecues*

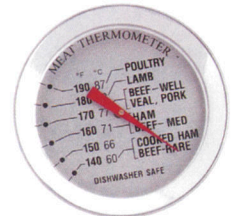

*Meat Thermometer - takes the guess work out of cooking by telling you when your food is cooked*



*Chef Set - all you need to look like a pro*



*Baking Dish - for casseroles and other foods that need to be confined or contained*



*Motorised Rotisserie - cooks evenly without being too close to direct heat*

E-mail: [mail@beefeaterbbq.com](mailto:mail@beefeaterbbq.com)  
Website: [www.beefeaterbbq.com](http://www.beefeaterbbq.com)

4.5 DISBBQINS\_AU 1.4