

This Owner's Manual is provided and hosted by [Appliance Factory Parts](#).



CUISINART COS-244 Owner's Manual

[Shop genuine replacement parts for CUISINART
COS-244](#)



[Find Your CUISINART Grill Parts - Select From 152 Models](#)

----- Manual continues below -----

Cuisinart®

Outdoor Grilling Products

VERTICAL 36" PROPANE SMOKER

MODEL: COS-244

ASSEMBLY AND OPERATING INSTRUCTIONS

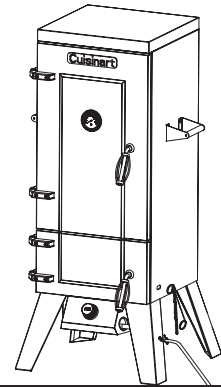

⚠ WARNING: FOR OUTDOOR USE ONLY

- ⚠ This instruction manual contains important information necessary for the proper assembly and safe use of the appliance
- ⚠ Read and follow all warnings and instructions before assembling and using the appliance
- ⚠ Follow all warnings and instructions when using the appliance
- ⚠ Keep this manual for future reference



Note to installer: Leave this Owner's Manual with the consumer after delivery and/or installation.
Note to customer: Leave this Owner's Manual in a convenient place for future reference.

⚠ DANGER

1. Do not store or use gasoline or other flammable liquids or vapors in the vicinity of this or any other appliance.
2. An LP cylinder not connected for use shall not be stored in the vicinity of this or any other appliance.

⚠ DANGER

- If you smell gas:
1. Shut off gas to the appliance.
 2. Extinguish any open flame.
 3. Open doors.
 4. If odor continues, keep away from the appliance and immediately call your fire department.

⚠ WARNING

CALIFORNIA PROPOSITION 65

1. Combustion by-products produced when using this product contain chemicals known to the State of California to cause cancer, birth defects, and other reproductive harm.
2. This product contains chemicals, including lead and lead compounds, known to the State of California to cause cancer, birth defects or other reproductive harm.

Wash your hands after handling this product.

⚠ DANGER

Failure to follow these instructions could result in fire, explosion or burn hazard, which could cause property damage, personal injury or death.

⚠ WARNING

Burning wood chips gives off carbon monoxide, which has no odor and can cause death. **DO NOT** burn wood chips inside homes, vehicles, tents, garages, or any enclosed areas. Use only outdoors where it is well ventilated.

⚠ DANGER

1. Never operate this appliance unattended.
2. Never operate this appliance within 10 feet (3.05m) of any other gas cylinder.
3. Never operate this appliance within 25 feet (7.5m) of any flammable liquid.
4. If a fire should occur, keep away from the appliance and immediately call your fire department. Do not attempt to extinguish an oil or grease fire with water.
5. Heated liquids remain at scalding temperatures long after the cooking process. Never touch cooking appliance until liquids have cooled to 115°F (45°C) or less.

⚠ DANGER

Failure to follow these instructions could result in fire, explosion or burn hazard, which could cause property damage, personal injury or death.

Table of Contents

1. Warnings and Safety Instructions	3
2. Illustrated Parts List	4
3. Exploded View	5
4. Assembly Instructions	6
5. Operating Your Smoker	
5.1 Select a proper location	11
5.2 Special Instructions for the use of regulator and cylinder	11
5.3 Checking for gas leak	12
5.4 Lighting instructions	12
5.5 Match lighting	13
5.6 Using the Smoker	13
6. Care and Maintenance	14
7. FAQ and Troubleshooting	15
8. Warranty Program and Replacement Parts	16

1. Warnings and Safety Instructions























If these instructions are ignored, there is a possibility of a hazardous fire or explosion which could result in physical injury or property damage! It is your responsibility to assemble, operate and maintain your gas smoker properly.

READ ALL WARNINGS AND INSTRUCTIONS PRIOR TO ASSEMBLING AND OPERATING YOUR SMOKER

WARNINGS:

- ⚠ This smoker is for outdoor use only. It should NOT be used in a building, garage or any other enclosed area.
- ⚠ The use of alcohol, prescription or non-prescription drugs may impair an individual's ability to properly assemble or safely operate this appliance.
- ⚠ Do not leave the smoker unattended.
- ⚠ Keep children and pets away from the smoker at all times.
- ⚠ Do not use the smoker in high wind.
- ⚠ This smoker must be used with propane gas only. Liquid propane is not natural gas. The conversion or attempted use of natural gas in a liquid propane smoker is dangerous and will void your warranty.
- ⚠ Do not attempt to attach this smoker to the self-contained propane system of a camper, trailer, motor home or house.
- ⚠ Do not use charcoal or lighter fluid.
- ⚠ Do not use gasoline, kerosene or alcohol for lighting. The LP-gas cylinder must be constructed and marked in accordance with the specifications for propane gas cylinder of the U.S. Department of Transportation (DOT).
- ⚠ Do not move appliance when in use. Allow the smoker to cool to 115° (45) before moving or storing.
- ⚠ Do not use the smoker unless it is COMPLETELY assembled and all parts are securely fastened and tightened. If there are any missing or damaged parts, contact customer service for a replacement.
- ⚠ Do not alter the smoker in any manner.
- ⚠ Do not operate the smoker if there is a gas leak present.
- ⚠ The use and installation of this product must conform to local codes. In the absence of local codes, use the National Fuel Gas Code: ANSI/NFPA 58 or Natural Gas and Propane Installation Code, CSA B149.1; Propane Storage and Handling, CSA B149.2. Natural Gas and Propane Installation Code.
- ⚠ This appliance is not intended to be installed in or on a boat or recreational vehicle.
- ⚠ Locate the smoker away from any combustible or non-combustible materials or construction by at least 24 inches (61cm) from the back and sides.
- ⚠ The appliance shall not be used under overhead unprotected combustible construction.
- ⚠ This appliance is not intended for and should never be used as a heater.
- ⚠ This appliance will be hot during and after use. Use insulated oven mitts or gloves for protection from hot surfaces or splatter from cooking liquids.
- ⚠ This appliance is not intended for commercial use.
- ⚠ The pressure regulator supplied with the Cuisinart Vertical 36" Propane Smoker must be used.
- ⚠ PROPOSITION 65 WARNING: Handling the brass material on this product exposes you to lead, a chemical known to the state of California to cause cancer, birth defects or other reproductive harm. (Wash hands after handling this product.)

2. Illustrated Parts List

A		N		A Smoker Body	1 pc
B		O		B Front Left/Back Right Legs	2 pcs
C		AA		C Front Right/Back Left Legs	2 pcs
D		BB		D Burner Box Assembly	1 pc
E		CC		E Air Vent	1 pc
F		DD		F Upper Door	1 pc
G		EE		G Lower Door	1 pc
H		FF		H Handles	2 pcs
J		GG		J Door Handles	2 pcs
K		HH		K Door Hinges	4 pcs
L				L Cooking Rack supports	8 pcs
M				M Cooking Rack	4 pcs
				N Water/Wood Chip Tray	1 pc
				O Match Holder	1 pc
				AA M6 x 12 screw	16 pcs
				BB M5 x 10 screw	9 pcs
				CC M6 nut	4 pcs
				DD M6 x 10 screw	8 pcs
				EE M6 x 40 screw	16 pcs
				FF Nut	8 pcs
				GG Washer	8 pcs
				HH M5 x 20 shoulder screw	1 pcs

3. Exploded View

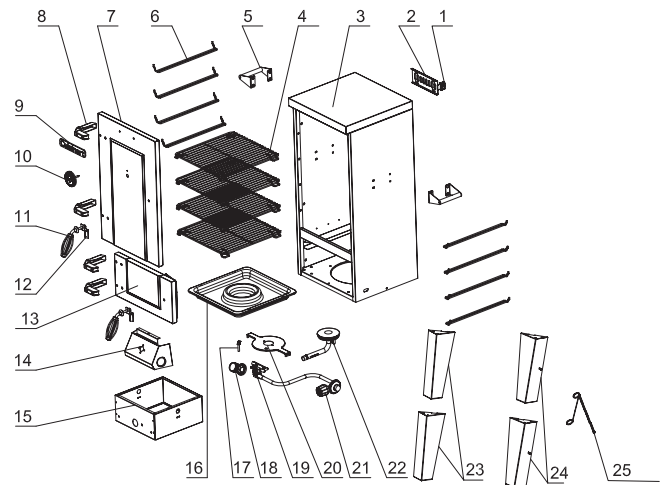

1	Air Vent Handle	10	Thermometer	19	Valve Assembly
2	Air Vent	11	Door Handles	20	Burner Support
3	Smoker Body	12	Door Handle Lock	21	Regulator
4	Cooking Racks	13	Lower Door	22	Burner
5	Handles	14	Control Panel	23	Front Left/Back Right Legs
6	Cooking Rack Supports	15	Burner Box	24	Front Right/Back Left Legs
7	Upper Door	16	Water/Wood Chip Tray	25	Match Holder
8	Door Hinges	17	Electrode		
9	Logo Plate	18	Control Knob		

4. Assembly Instructions

Remove all the contents from packaging, and ensure all parts are present before attempting to assemble. (See Parts List on page 4)

Step 1:

Turn smoker body upside down. Use screws (AA) to connect legs to the bottom of the smoker body. Match legs with stickers to the stickers on the smoker body.)

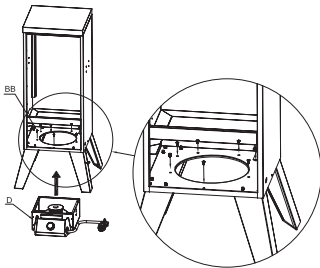
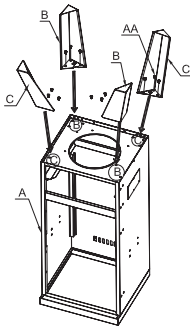

Step 2:

Flip smoker right-side up. Use screws (BB) to connect burner box to smoker.

Step 3:

Remove air vent handle from vent and use screws (AA) and nuts (CC) to connect the vent to the smoker. Then insert the air vent handle onto the air vent.

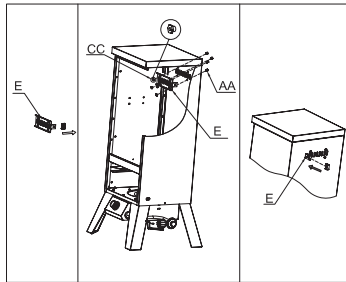

6

Step 4:

Use screws (DD), nuts (FF) and washers (GG) to connect handles to smoker.

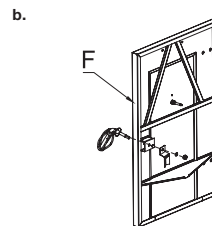
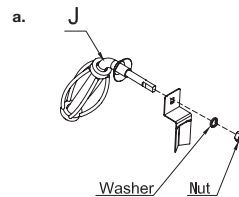
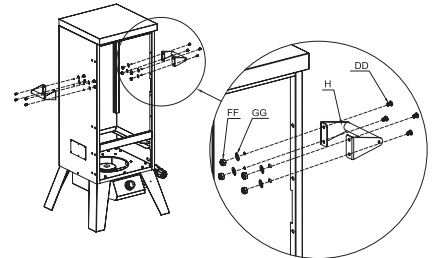

Step 5:

- Remove door handle lock (with washer and nut) from door handle.
- Insert door handle shaft through door handle hole. Reattach door handle lock (with washer and nut) to door handle shaft.

7

4. Assembly Instructions (cont.)

Step 6:

Use screws (AA) and nuts (CC) to
Repeat step 5 for bottom door.

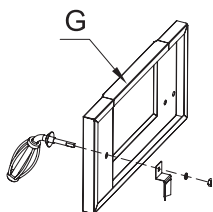

Step 7:

Use screws (EE) to connect
hinges to smoker body.

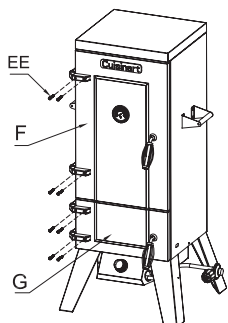
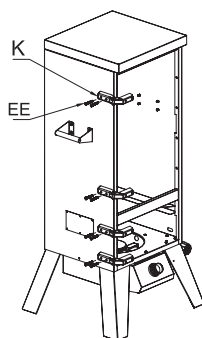

Step 8:

Use screws (EE) to connect upper
door to hinges. Use screws (EE) to
connect lower door to hinges.

Step 9:

Insert cooking rack supports into smoker box holes and angle
downward until they sit flat (see zoomed in image to the right).
Insert four cooking rack supports per side.

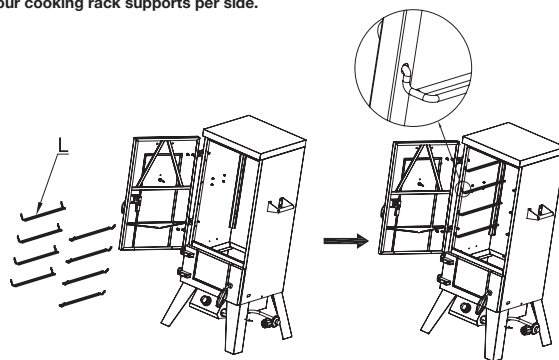

Step 10:

Slide cooking racks onto
cooking rack supports.

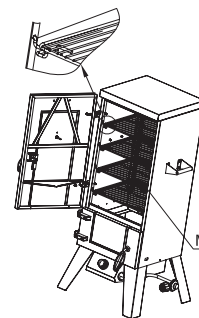

4. Assembly Instructions (cont.)

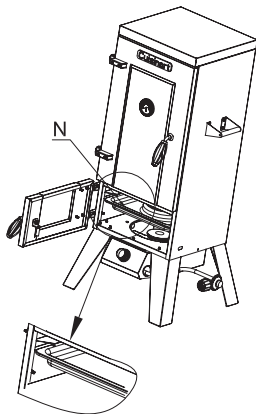

Step 11:
Open bottom door and slide
water/wood chip tray into built
in brackets.

Step 12:
Connect the match holder to the
smoker body using screw (HH).

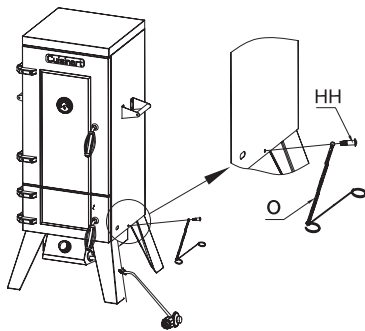

5. Operating Your Smoker

5.1 Select a Proper Location

Once you have assembled your new smoker, find a suitable location for use.

Note: The use and installation of this product must conform to local codes. In absence of local codes, use the National Fuel Gas Code: ANSI Z223.1/NFPA54, Storage and Handling of Liquefied Petroleum Gases, ANSI/NFPA 58 or Natural Gas and Propane Installation Code, CSA B149.1; Propane Storage and Handling, CSA B149.2.

⚠ DANGER

1. Never use this outdoor smoker inside any building, garage, shed or breezeway, or inside any boat, trailer or recreational vehicle and/or boat, to prevent possible fire and to prevent the possibility of carbon monoxide poisoning or asphyxiation.
2. Always place your smoker on a hard and level surface far away from combustible materials and structures.
3. Do not use this smoker under an overhead combustible surface or covered area (e.g., awnings, umbrellas, porches or gazebos). Keep all combustible surfaces at least 24" (61cm) away.
4. Locate the smoker away from any combustible and non-combustible material or construction by at least 24 inches (61cm) from back and 24 inches (61cm) from side. (See the diagram below)
5. Never store or use gasoline or other flammable or volatile substances in the vicinity of this smoker or in the vicinity of any other heat-generating appliance, because of the danger of starting a fire.
6. The cylinders can be disconnected when the appliance is not in use.

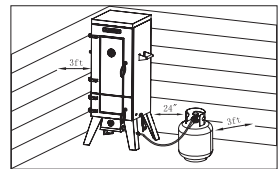

5.2 Special Instructions for the Use of Regulator and Propane Cylinder

GAS HOOK-UP Only the pressure regulator and hose assembly supplied with the smoker should be used. Any replacement pressure regulator and hose assembly must be specified by the smoker manufacturer. This smoker is configured for Liquid Propane. Do not use a Natural Gas supply.

LIQUID PROPANE CYLINDER REQUIREMENTS: (20-lb Cylinder) A dented or rusty Liquid Propane cylinder may be hazardous and should be checked by your supplier. Never use a cylinder with a damaged valve. The Liquid Propane cylinder must be constructed and marked in accordance with the specifications for Liquid Propane cylinders by the United States Department of Transportation (DOT) or the National Standard of Canada, CAN/CSA-B339, Cylinders, Spheres and Tubes for Transportation of Dangerous Goods Commission. The 20-lb cylinder must have a shut off valve terminating in a valve outlet specified, as applicable, for connection type QCC1 in the standard for compressed gas cylinder valve outlet and inlet connection ANSI/CGA-V-1. Storage of an outdoor cooking gas appliance indoors is permissible only if the cylinder is disconnected and removed from the outdoor cooking gas appliance. The cylinder system must be arranged for vapor withdrawal. The cylinder must include a collar to protect the cylinder valve. Manifold pressure: (operating) 11 inches water column (W.C.), (non-operating) 11.2 inches water column (W.C.). The Liquid Propane cylinder must be fitted with an Overfill Protection Device (OPD). Remove the plastic valve cover from the Liquid Propane cylinder. Make sure the smoker gas hoses do not contact the grease pan or smoker firebox when the Liquid Propane cylinder is placed into the cart.

CONNECTING THE LIQUID PROPANE CYLINDER: To connect the Liquid Propane gas supply cylinder: The cylinder valve should be in the "OFF" position. If not, turn the valve clockwise until it stops. Make sure the cylinder valve has the proper type-1 external male thread connections per ANSI Z21.61. Make sure the burner valves are in the "OFF" position. Inspect the valve connections, port and regulator assembly. Remove debris and inspect the hose for damage. When connecting the regulator assembly to the valve, use your hand to tighten the nut clockwise until it stops. Use of a wrench could damage the quick coupling nut and result in a hazardous situation. Open the cylinder valve fully by turning the valve counterclockwise. Before lighting the smoker, use a soap and water solution to check all the connections for leaks. If a leak is found, turn the cylinder valve "OFF" and do not use the smoker until a local Liquid Propane dealer can make repairs.

5. Operating Your Smoker (cont.)

WARNING!

Never attempt to use damaged or obstructed equipment. See your local Liquid Propane dealer for repair.

DISCONNECTING THE LIQUID PROPANE CYLINDER Turn the smoker burner valves "OFF" and make sure the smoker is cool. Turn the Liquid Propane cylinder valve "OFF" by turning clockwise until it stops. Detach the regulator assembly from the cylinder valve by turning the quick coupling nut counterclockwise. Place dust cap on cylinder valve outlet whenever the cylinder is not in use. Only install the type of dust cap on the cylinder valve outlet that is provided with the cylinder valve. Other types of caps or plugs may result in leakage of propane.

5.3 Checking for Gas Leak

LEAK TESTING GENERAL: Although gas connections on the smoker are leak tested prior to shipment, a complete leak test must be performed at the installation site. Before each use, check all gas connections for leaks using the procedures listed below. If the smell of gas is detected at any time, you should immediately check the entire system for leaks.

BEFORE TESTING: Make sure all packing materials have been removed from the smoker. Make a solution of one part liquid detergent and one part water. You will need a spray bottle, brush, or rag to apply the solution to the fittings. For the initial leak test, make sure the Liquid Propane cylinder is full.

TO TEST

1. Turn the burner valves off.
2. Turn the Liquid Propane cylinder valve counterclockwise to open the valve.
3. Apply the soap solution to all gas fittings. Soap bubbles will appear where a leak is present.
4. If a leak is present, immediately turn the gas supply "OFF" and tighten leaky fittings.
5. Turn the gas back "ON" and recheck.
6. Should the gas continue to leak from any of the fittings, turn the gas supply "OFF" and contact customer service at 866-994-6390 or email Grilling@TheFulhamGroup.com
7. If there is evidence of excessive abrasion or wear, or the hose is cut, it must be replaced prior to the outdoor cooking gas appliance being put into operation. Only those parts recommended by the manufacturer should be used on the smoker. Substitutions will void the warranty.

WARNING!

Do not store smoker indoors unless the cylinder is disconnected. Do not store cylinder in a building, garage, or any other enclosed area, and keep area, and keep out of reach of children at all times.

INSTALLER FINAL CHECK Maintain specified clearance of 36 inches from combustible materials and construction.

- All internal packaging has been removed.
- The hose and regulator are properly connected to the Liquid Propane cylinder.
- The unit has been tested and is free of leaks.
- The gas supply shutoff valve has been located.
- All burners are installed.
- Keep the instruction manual for future reference

5.4 Lighting the Smoker

1. Make sure the propane cylinder is tightly threaded into the regulator (hand tighten only).
2. Open bottom door. Always open bottom door when lighting.
3. Push and turn control knob slowly counterclockwise to IGNITE/HI. Burner should light immediately.

12

4. If ignition does not occur in 3-5 seconds, turn the control knob "OFF". Wait 5 minutes before attempting to re-light the smoker. If the smoker fails to ignite after the third attempt, call customer service at 1-866-994-6390 for assistance. With burner lit, gently close the bottom door and allow the smoker to warm up for prior to use.

Note: If the knob can't spark, insert a match into the match holder. Ignite the match and insert through the opening in the bottom door toward the burner.

TURNING THE SMOKER OFF

1. Turn knob to "OFF" position.
2. Turn the propane cylinder control knob to the "OFF" position. Caution: Do not attempt to re-light the smoker without following all the lighting instructions.
3. Allow the smoker body to cool at least 30 minutes before attempting to move or transport.

5.5 Match lighting

IMPORTANT!

1. Read all instructions before lighting.
2. Make sure the gas control knob is in "OFF" position.
3. Open doors during lighting.
4. Strike a long wooden match and position the burning match to the burner box. Place the flame near the bottom edge of the burner.
5. Push down and turn the control knob counterclockwise to the high setting.
6. The burner should light. The flame will carry around the burner.

CAUTION:

Do not touch any hot smoker parts. The outside of the smoker bottom especially becomes very hot during use. Use protective gloves to handle any parts that might become hot during use.

5.6 Using the Smoker

- Add wood chips to bowl portion (inner ring) of water/wood chip bowl. If you presoak wood chips for 30 minutes in water, drain, and then add to wood chip bowl, wood chips will last longer before burning up
- Fill the rest of the tray with water-this will add moisture to the air to keep food from drying out. Water also helps maintain a consistent air temperature. Add juice, beer, or vinegar to the water bowl to add additional flavor to whatever you're smoking as the liquid evaporates
- Follow lighting instructions to light smoker
- Close smoker doors and let smoker heat to desired temperature before adding food
- Wood chips are necessary to provide smoke
- Keep doors closed at all times except when adding wood chips or water or adding/removing/checking on food. Opening doors will lose smoke and heat and can cause the wood to flare up
- Adjust control knob and air vent to control temperature (if temperature is getting too high even after making adjustments-add more water to water tray)
- Open lower door to slide water/wood chip bowl out to refill
- Clean out wood chip bowl after each use to prevent ash buildup
- It is normal for smoke to quickly create a brown/black buildup along the inside of the smoker

13

6. Care And Maintenance

6.1 Care

Regular care of your smoker will help keep it operating properly. All maintenance should be done only when the smoker is cool and with the fuel supply turned off. Occasionally inspect and tighten hardware that may become loose.

WARNING!

Do not disassemble or alter the fuel supply system. Improper assembly can result in a hazardous condition. Seek qualified professional assistance if repairs are required.

6.2 Cleaning And Maintenance

- **WARNING: Do not clean any cooking surface while smoker is operating. Let smoker cool to a safe temperature prior to cleaning.**
- Disconnect the fuel supply and remove the fuel supply cylinder prior to cleaning.
- Cleaning should be done where detergent won't harm work surface or lawn.

Exterior Cleaning

- Clean smoker exterior surfaces with warm soapy water.
- Wash drip tray in warm soapy water – do not run through dishwasher.

Interior Cleaning

- Cooking grate can be cleaned with a smoker brush. For best results, cooking grate should be warm (warm, not hot – never brush with smoker operating, or when interior is very hot). If desired, cool cooking grate can be removed from smoker and cleaned with warm soapy water.

- **WARNING: DO NOT APPLY ANY CLEANERS OR LIQUIDS TO BURNER ELEMENT OR ATTEMPT TO CLEAN IN ANY WAY.**
- **DO NOT USE WATER OR LIQUIDS TO CLEAN SMOKER INTERIOR**

7. FAQ and Troubleshooting

Frequently Asked Questions

Should I use wood chips or wood chunks?

You can use wood chips or wood chunks. Wood chunks will take longer to produce smoke.

Should I presoak the wood chips or use them dry?

Both are acceptable options. The dry chips with burner faster with a more intense smoke. The pre-soaked chips will burn slower.

Is it O.K. to use the smoker with no water in the water bowl?

Yes. But, water will help control the temperature and the steam from the water will keep the food moist. Filling the water bowl with cold water will help lower the smoker temperature.

How much wood should I put in the wood chip bowl?

Fill the wood chip bowl about half an inch above the rim of the bowl. Refill wood chips when chips stop producing smoke.

Can I use the smoker in my garage?

No. Do not use smoker in any enclosed or covered areas. Keep smoker 10+ feet from any building.

Troubleshooting

Burner Won't Light

- Be sure LP tank still has fuel in it
- Ensure LP tank is correctly threaded into hose (not cross threaded) and fully tightened
- Check to see that burner orifice holes are clear. If obstructed, with gas tank disconnected, gently brush orifice holes with a small brush
- Check to see that igniter is producing a spark against the burner (best checked in shady spot).
- Ensure that LP tank supply valve is open (turned counterclockwise until stop)
- Ensure that the orifice at the end of the hose is not obstructed or damaged
- Straighten sharp kinks in hose

Smoker doesn't reach high enough temperature (using 20lb LP tank with conversion hose)

Your LP tank has a safety device that is intended to reduce gas flow in the event of a leak. When this device is active, it is commonly called "bypass". This device can be inactivated by not following proper lighting procedures. Should you experience low flame, you should do the following:

- 1) shut off smoker
- 2) close tank valve fully
- 3) remove hose from tank for one minute to relieve pressure, then re-attach

Then, restart the smoker (and start the smoker each time) using the proper procedure:

- 1) ensure the smoker fuel knob is turned to OFF
- 2) slowly open the gas tank valve fully
- 3) WAIT 15 SECONDS
- 4) follow the smoker lighting steps (printed on smoker, and in owner's manual)

For additional FAQs, please visit www.cuisinartgrilling.com

8. Warranty and Replacement Parts

This warranty covers defects in parts and workmanship for a period of 3 years from the original purchase date. Any damage claim regarding the enameling must be submitted within 30 days of purchase to be covered by the warranty.

The following conditions are NOT covered by this warranty:

- Unevenness and color variations in the coated surfaces.
- Damage caused by improper assembly or disregard of the manual.
- Use of spare parts not supplied by manufacturer.
- Damage resulting from modifications or inappropriate use.
- Abuse of the smoker
- Damage caused by improper maintenance or repairs by an unauthorized person.

Limitations and exclusions:

1. This warranty applies only to the original purchaser and may not be transferred.
2. If you can not verify the purchase date of the smoker the warranty period will begin on the date the smoker was manufactured.
3. Replacement or repair parts are warranted for the remaining period of the original part warranty.

Your obligations:

This smoker must be assembled, installed, operated and maintained in accordance with all applicable codes and the instruction manual furnished with this smoker. You must keep an invoice, cancelled check or payment record to verify the purchase date of the smoker.

For troubleshooting, FAQs or customer service, visit us at www.cuisinartgrilling.com or contact us by phone at 1-866-994-6390 or email at grilling@thefulhamgroup.com

To order replacement parts or additional Cuisinart Grilling products, visit us at www.cuisinart.com or call 1-800-211-9604

Model# COS-244

North American Distributor:

The Fulham Group

Newton, MA 02466