

This Owner's Manual is provided and hosted by [Appliance Factory Parts](#).



# Napoleon GDIX4N Owner's Manual

[Shop genuine replacement parts for Napoleon GDIX4N](#)



[Find Your Napoleon Fireplace Parts - Select From 171 Models](#)

----- Manual continues below -----

# OAKVILLE™ X4 GAS INSERT



## Specifications

Model	BTU	Width	Height	Depth	Viewing Area
GDIX4	40,000 (NG) 36,000 (P)	33 3/4"	24 9/16"	17 3/4"	27 3/4" x 18 11/16"

## Front Options Backer Plates

Product Code	A	B	C	D	E
MBK3B2844	44"	28 1/2"	1"	33 7/8"	23 1/2"
LBK3B3047	47"	30"	1"	33 7/8"	23 1/2"

Product Code	A	B	C	D	E
BK4B3544	44"	35"	1"	33 7/8"	23 1/2"

## Face Plates

Product Code	A	B	C	D	E
S_3F3B4	35 7/8"	24 3/8"	1 5/16"	30 7/8"	21 7/8"
L_3F3B4	40 7/8"	26 7/8"	1 5/16"	30 7/8"	21 7/8"

Product Code	A	B	C	D	E
S_4F3B4	35 7/8"	24 3/8"	1 5/16"	30 7/8"	20 3/8"
S_4F4B4	35 7/8"	25 3/8"	1 5/16"	30 7/8"	20 3/8"
L_4F4B4	40 7/8"	30 3/8"	1 5/16"	30 7/8"	20 3/8"

Product Code	A	B	C	D	E
SA_4F3B4	35 7/8"	26 1/16"	1 5/16"	30 7/8"	19 7/16"

## Dimensions

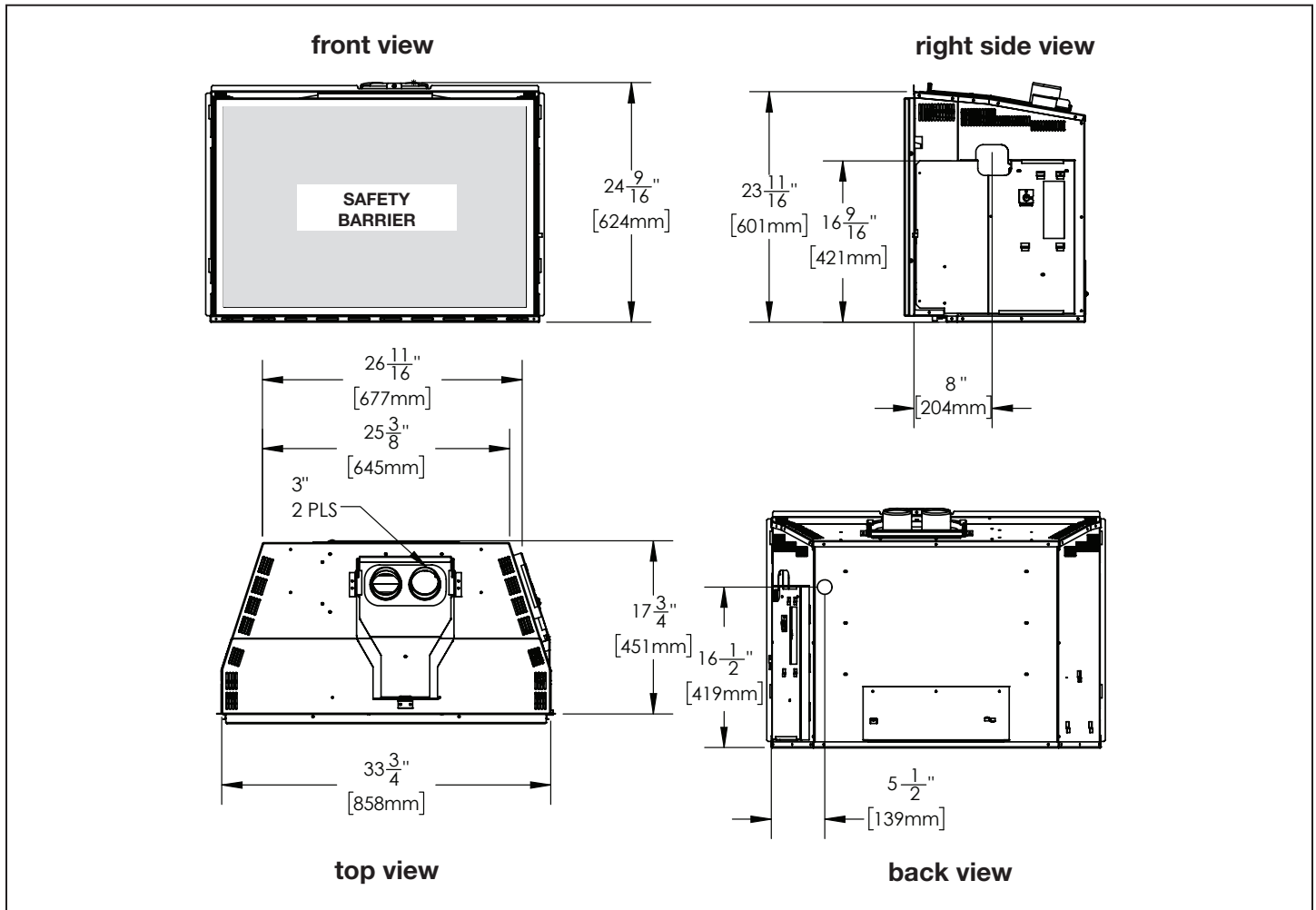

## Minimum Mantel Clearances

Combustible mantel clearance can vary according to the mantel depth. Use the graph to help evaluate the clearance needed. These same requirements apply to any combustibles protruding on either side of the appliance.

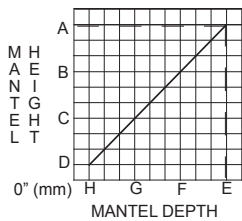

6" (152mm) MANTEL

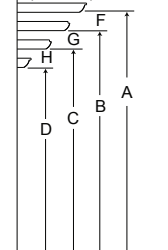

### MANTEL DIMENSIONS

<b>A</b>	15" (38.1cm)
<b>B</b>	14" (35.5cm)
<b>C</b>	13" (33cm)
<b>D</b>	12" (30.5cm)
<b>E</b>	6" (152mm)
<b>F</b>	5" (127mm)
<b>G</b>	4" (102mm)
<b>H</b>	3" (76mm)

23 <sup>11</sup>/<sub>16</sub>" (60.1cm)

## Minimum Clearance to Combustibles

This appliance must be recessed into a vented non-combustible wood-burning appliance (prefabricated or masonry) only. The minimum appliance opening size in which the appliance is to be installed is:

- **HEIGHT 24 3/4" (62.8cm)**
- **WIDTH 34 5/16" (87.1cm)**
- **DEPTH 18 1/4" (46.3cm)**

**The minimum allowable chimney flue size is 6" (152mm) round.**

The minimum distance, from the bottom of a combustible mantel projecting 3" (76mm) maximum from the wall to the top of the appliance, is 12" (30.5cm) (see "minimum mantel clearances" section).

Product information provided is not complete and is subject to change without notice. Please consult the installation manual for the most up to date installation information.

W415-1947 / E / 10.24.19

## Spécifications

Modèle	BTU	Largeur	Hauteur	Profondeur	Dimensions de Vision
GDIX4	40,000 (NG) 36 000 (P)	33 3/4"	24 9/16"	17 3/4"	27 3/4" x 18 11/16"

## Façades Décoratives

### Plaques Arrières

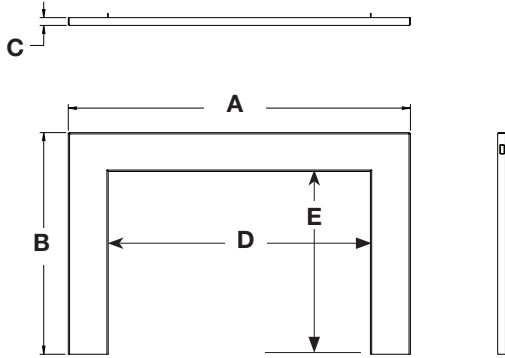

Code de Produit	A	B	C	D	E
MBK3B2844	44"	28 1/2"	1"	33 7/8"	23 1/2"
LBK3B3047	47"	30"	1"	33 7/8"	23 1/2"

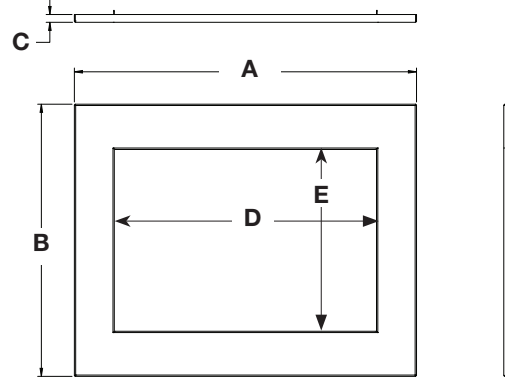

Code de Produit	A	B	C	D	E
BK4B3544	44"	35"	1"	33 7/8"	23 1/2"

### Plaques Frontale

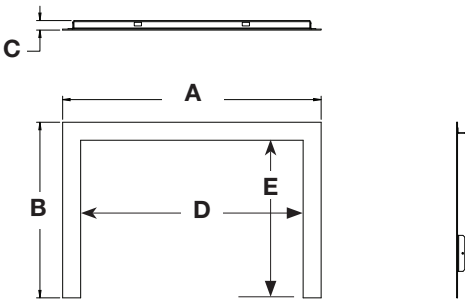

Code de Produit	A	B	C	D	E
S_3F3B4	35 7/8"	24 3/8"	1 5/16"	30 7/8"	21 7/8"
L_3F3B4	40 7/8"	26 7/8"	1 5/16"	30 7/8"	21 7/8"

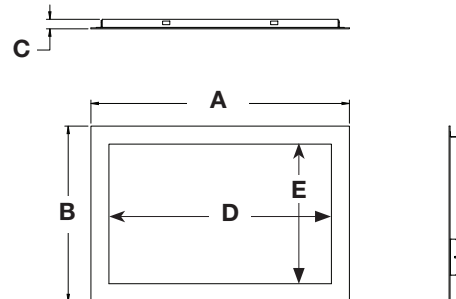

Code de Produit	A	B	C	D	E
S_4F3B4	35 7/8"	24 3/8"	1 5/16"	30 7/8"	20 3/8"
S_4F4B4	35 7/8"	25 3/8"	1 5/16"	30 7/8"	20 3/8"
L_4F4B4	40 7/8"	30 3/8"	1 5/16"	30 7/8"	20 3/8"

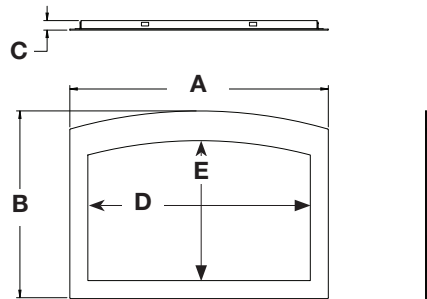

Code de Produit	A	B	C	D	E
SA_4F3B4	35 7/8"	26 1/16"	1 5/16"	30 7/8"	19 7/16"

## Dimensions

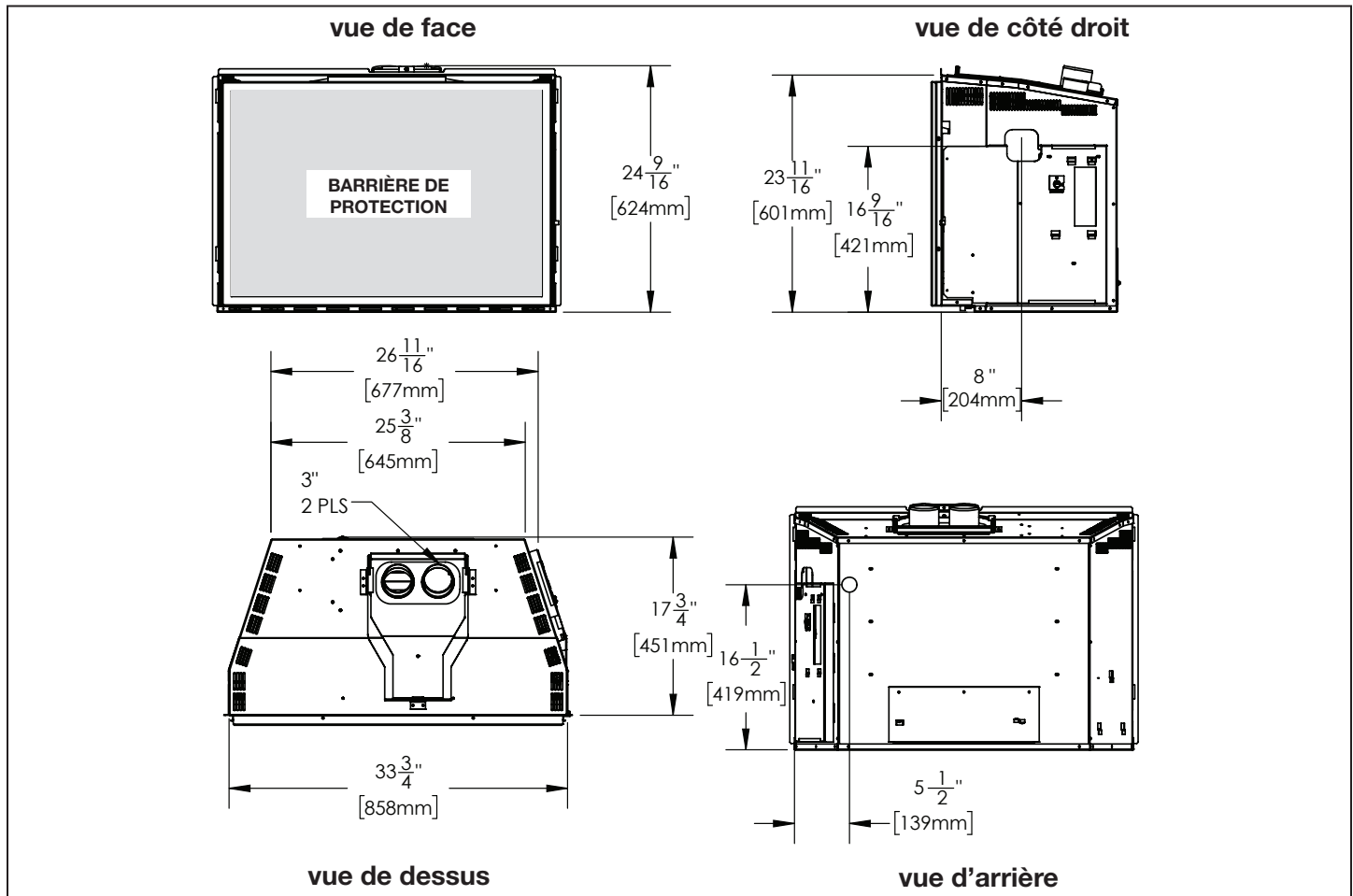

## Dégagements Minimaux de Tablette

Le dégagement d'une tablette combustible à l'appareil peut varier selon la profondeur de la tablette. Utilisez le graphique pour vous aider à déterminer le dégagement nécessaire. Les mêmes dégagements aux matériaux combustibles s'appliquent pour toutes les surfaces en projection sur les côtés de l'appareil.

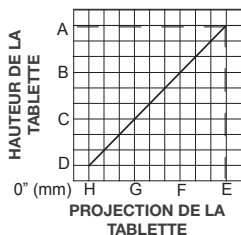

6" (152mm) TABLETTE

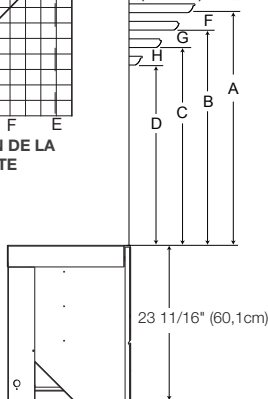

DIMENSIONS	
A	15" (38,1cm)
B	14" (35,5cm)
C	13" (33cm)
D	12" (30,5cm)
E	6" (152mm)
F	5" (127mm)
G	4" (102mm)
H	3" (76mm)

## Dégagement Minimaux aux Matériaux Combustibles

Cet appareil ne doit être encastré que dans un foyer à bois ventilé incombustible (préfabriqué ou en maçonnerie). L'appareil dans lequel l'encasté est installé doit avoir les dimensions minimales suivantes:

- HAUTEUR 24 3/4" (62,8cm)
- LARGEUR 34 5/16" (87,1cm)
- PROFONDEUR 18 1/4" (46,3cm)

**Le diamètre minimal du conduit de la cheminée doit être de 6" (152mm) rond.**

La distance minimale entre le dessous d'une tablette décorative combustible qui ressort un maximum de 3" (76mm) et le haut de l'ouverture des persiennes est de 12" (30,5cm) (voir la section « dégagements minimaux de la tablette »).

**Information du produit fourni n'est pas complet et est sujet de changer sans préavis. Consultez le manuel d'installation pour information d'installation actuel.**