

This Owner's Manual is provided and hosted by [Appliance Factory Parts](http://www.appliancefactoryparts.com).

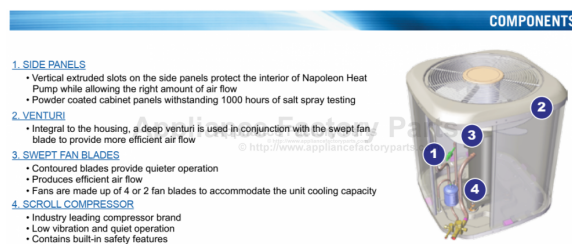

Napoleon NT14H048A Owner's Manual

**[Shop genuine replacement parts for Napoleon
NT14H048A](#)**



[Find Your Napoleon HVAC Parts - Select From 105 Models](#)

----- Manual continues below -----

Technical Specifications



SPLIT SYSTEM HEAT PUMPS

Conforms to UL Standard 1995. Certified to CAN/CSA Standard C22.2 No.236.



Environmentally Responsible

Napoleon Heat Pumps are made with the environmentally conscious, chlorine-free refrigerant R-410A. By using a refrigerant that is chlorine-free, Napoleon Heat Pumps do not contribute to ozone depletion.

FEATURES AND BENEFITS

- 14.5 SEER / 8.5 HSPF
- Capacities ranging from 1.5 tons to 4.0 tons
- Environmentally friendly R-410A refrigerant
- High Efficiency Copeland Scroll Compressors
- Fin and Tube Condenser
- Swept Fan Blades
- Permanently lubricated PSC motor
- Motor assembly is removable from top of unit
- Service valves and refrigerant connections are located outside the cabinet for easy accessibility and servicing
- Electrical connections are accessible through a removable service panel

NOMENCLATURE

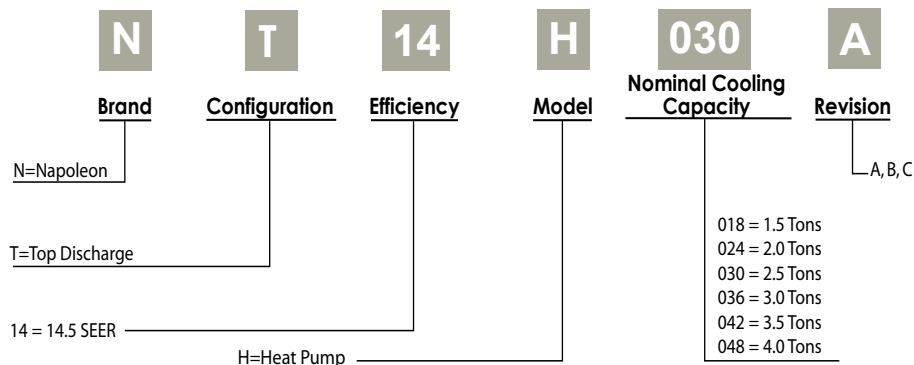

COMPONENTS

1. SIDE PANELS

- Vertical extruded slots on the side panels protect the interior of Napoleon Heat Pump while allowing the right amount of air flow
- Powder coated cabinet panels withstanding 1000 hours of salt spray testing

2. VENTURI

- Integral to the housing, a deep venturi is used in conjunction with the swept fan blade to provide more efficient air flow

3. SWEPT FAN BLADES

- Contoured blades provide quieter operation
- Produces efficient air flow
- Fans are made up of 4 or 2 fan blades to accommodate the unit cooling capacity

4. SCROLL COMPRESSOR

- Industry leading compressor brand
- Low vibration and quiet operation
- Contains built-in safety features



NT14H SPECIFICATIONS

DIMENSIONS

NOM SIZE	MODEL	W (inch)	D (inch)	H (inch)	Weight (lb)
1.5 Tons	NT14H018A	24	24	27	180
2.0 Tons	NT14H024A	24	24	27	180
2.5 Tons	NT14H030A	29 1/2	29 1/2	27	210
3.0 Tons	NT14H036A	29 1/2	29 1/2	27	210
3.5 Tons	NT14H042A	29 1/2	29 1/2	47 7/8	260
4.0 Tons	NT14H048A	29 1/2	29 1/2	47 7/8	260

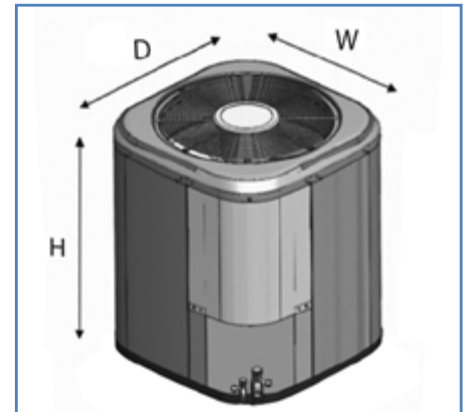

ELECTRICAL

DESCRIPTION	1.5 Tons	2.0 Tons	2.5 Tons	3.0 Tons	3.5 Tons	4.0 Tons
Compressor Type	Scroll	Scroll	Scroll	Scroll	Scroll	Scroll
Ref Charge (oz) 410A	125	120	149	145	268	266
Volt -Hz -Phase	208/230-60-1	208/230-60-1	208/230-60-1	208/230-60-1	208/230-60-1	208/230-60-1
Compressor LRA (A)	56.3	62.9	67.8	72.2	109.0	123.9
Compressor RLA (A)	9.0	10.9	12.8	14.1	16.7	17.0
Fan Blade Dia. / qty blades	18"/4	18"/4	24"/2	24"/2	24"/2	24"/2
Condenser Fan FLA / HP / RPM rated	0.7/ 1/8 /1075	0.7/ 1/8 / 1075	0.8/ 1/6 /850	0.8/ 1/6 /850	0.8/ 1/6 /850	0.8/ 1/6 /850
MCA	12.0	14.3	16.8	18.4	21.7	22.4
Max. Fuse/Breaker (A)	20	25	25	30	35	35

LINE SET

LINE SIZES	1.5 Tons	2.0 Tons	2.5 Tons	3.0 Tons	3.5 Tons	4.0 Tons
Liquid Line	3/8"	3/8"	3/8"	3/8"	3/8"	3/8"
Suction Line	3/4"	3/4"	3/4"	3/4"	7/8"	7/8"

PERFORMANCE

NOM SIZE	MODEL	Cooling Capacity Btu/h	SEER	Heating Capacity Btu/h	HSPF	SCFM Indoor Air Coil	Ref.
1.5 Tons	NT14H018A	18800	14.5	18000	8.5	660	410A
2.0 Tons	NT14H024A	23800	14.5	23000	8.5	840	410A
2.5 Tons	NT14H030A	28600	14.5	28000	8.5	1000	410A
3.0 Tons	NT14H036A	34000	14.5	33000	8.5	1200	410A
3.5 Tons	NT14H042A	40000	14.5	39600	8.5	1340	410A
4.0 Tons	NT14H048A	44000	14.5	43200	8.5	1580	410A



24 Napoleon Road, Barrie, Ontario, Canada L4M 0G8

PHONE: 866-820-8686 • FAX: 705-725-1150

Website: www.napoleonheatingandcooling.com

General: hvac@napoleonproducts.com

Technical inquiries: hvacsupport@napoleonproducts.com



NOTE:

ALL NAPOLEON HEAT PUMPS SHALL BE INSTALLED WITH PROPERLY MATCHED SYSTEM COMPONENTS LISTED ON AHRI DIRECTORY.