

This Owner's Manual is provided and hosted by [Appliance Factory Parts](#).



Napoleon CACM012A Owner's Manual

[Shop genuine replacement parts for Napoleon
CACM012A](#)



[Find Your Napoleon HVAC Parts - Select From 105 Models](#)

----- Manual continues below -----

NAPOLEON

CONDO
PACK

HIGH EFFICIENCY THRU WALL SELF CONTAINED
HEATING and COOLING UNITS
napoleonheatingandcooling.com

ARCHITECTURALLY INSPIRED.

We've reinvented high efficiency. Designed for conventional thru wall installation applications, Condo Pack is the most effective choice for a clean exterior look. Perfect for residential low and high rise applications as well as institutional and industrial installations.

Napoleon's streamlined design is an aesthetically pleasing solution for your unique architectural needs. By removing exterior equipment and from your application, your next installation will benefit with the added protection from extreme climate conditions and unforeseen pre-charged, our dual unit slide out chassis allows for easy installation and maintenance of both heating and cooling units.

Our industry leading quality control program ensures years of trouble free use for your peace of mind.

That's Napoleon.

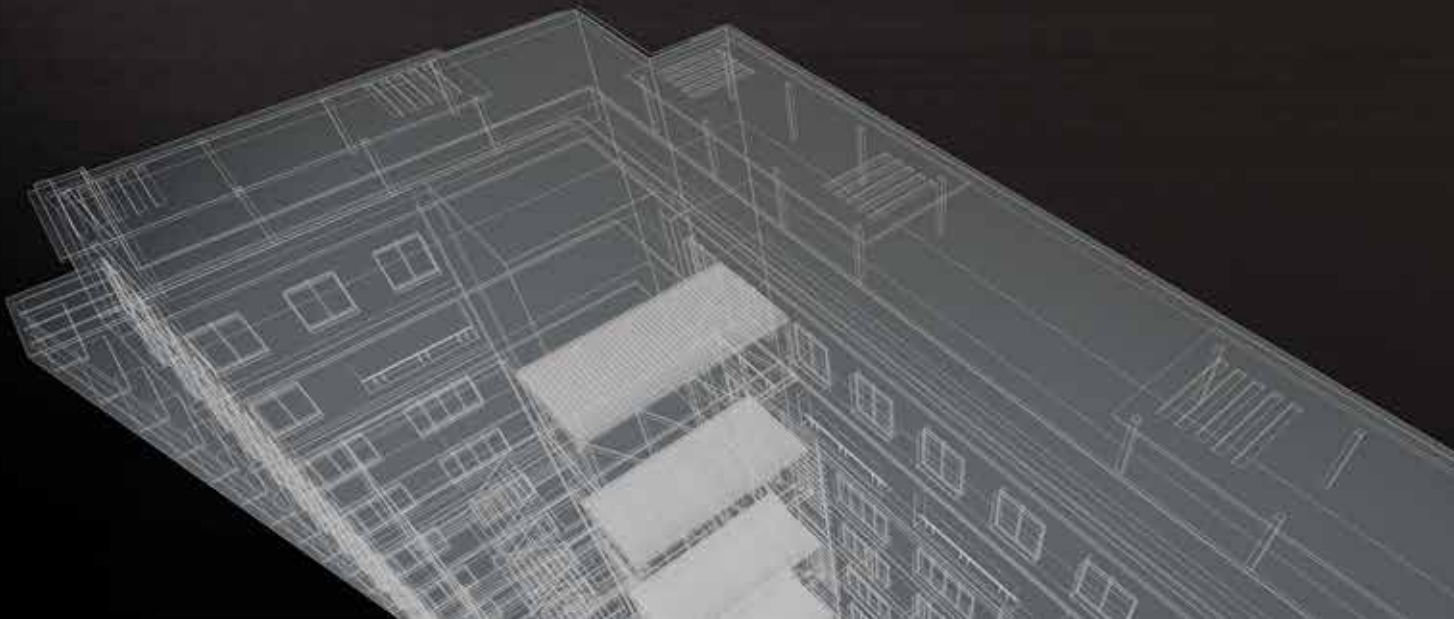

SERVICE ADVANTAGES

- Three piece design allows individual component handling for easy installation and serviceability
- All indoor access to parts and maintenance activities
- Innovative, dual slide out chassis for either heating or cooling components for service
- Both sections can be independently fully or partially removed for servicing
- With spare modules, building management can do quick swap outs to maintain climate in the apartment/condo while troubleshooting non functioning units off line
- Designed for direct replacement of the individual modules at the end of their service life instead of the complete appliance
- All control harnesses are separated with modular quick disconnects, so module swap outs do not require time consuming rewiring

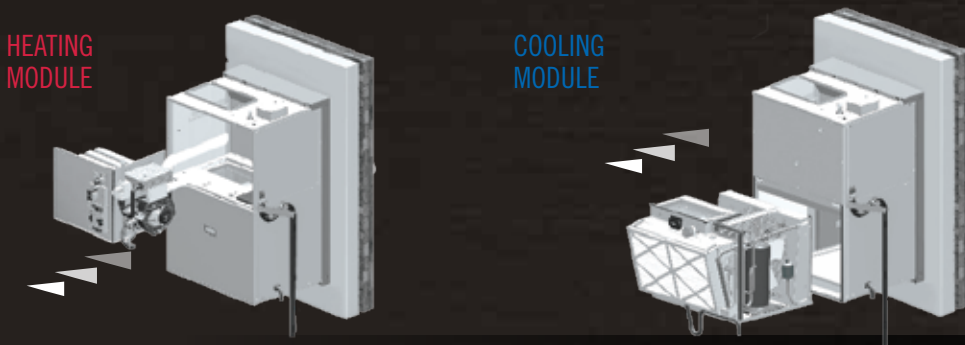

COLOUR MATCH

Napoleon offers a full color wheel of custom options to accent or enhance your condo development, any pantone color can be matched. Two louvre options are also offered to compliment your design.

Condopack can be matched to your exact color of brick, stone or stucco.



HEATING PRODUCT MODULE LINE-UP



● High-Efficiency

- 90% Thermal Rating, up to 96.8% AFUE
- Tubular stainless steel primary and secondary heat exchanger
- Natural gas or propane, direct vent
- Blower dynamically balanced with resilient motor mounts for noise reduction and smooth operation
- Independent metering and temperature control
- Direct vent design eliminates the need for a chimney
- Exterior condensate drain for ease of service

5 YEAR PARTS LIMITED WARRANTY

10 YEAR FURNACE MODULE REPLACEMENT LIMITED WARRANTY

20 YEAR HEAT EXCHANGER LIMITED WARRANTY

COOLING PRODUCT MODULE LINE-UP



● Air conditioner

- High efficiency *Copeland* scroll compressor
- Up to 10.8 SEER
- R-410A Refrigerant System
- Micro-Channel Condenser and Evaporator Coils
- High Efficiency Copeland Scroll Compressors
- Dual Inlet Blower for higher flow rates / reduced air noise
- Endura Pro Multi-Speed Electronically Commutated Motor for increased electrical efficiency

5 YEAR PARTS LIMITED WARRANTY

HEATING PRODUCT MODULE LINE-UP

Electric

- Up to 15kW Electric Resistance Heating
- Pre-wired
- Plug-and-play installation and service
- Individual metering and control for each unit

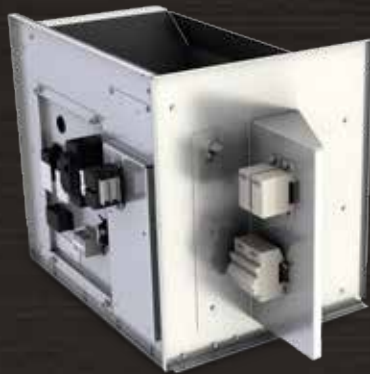

5 YEAR PARTS LIMITED WARRANTY

10 YEAR FURNACE MODULE REPLACEMENT LIMITED WARRANTY

Mid-Efficiency

- Up to 80 % AFUE/Thermal Efficiency Single Stage Gas Module
- Stainless steel heat exchanger
- Tubular stainless steel primary and secondary heat exchanger
- Blower dynamically balanced with resilient motor mounts for noise reduction and smooth operation
- Independent metering and temperature control
- Direct vent design eliminates the need for a chimney

5 YEAR PARTS LIMITED WARRANTY

10 YEAR FURNACE MODULE REPLACEMENT LIMITED WARRANTY

20 YEAR HEAT EXCHANGER REPLACEMENT LIMITED WARRANTY

Heat Pump

COMING SOON



5 YEAR PARTS LIMITED WARRANTY

Hydronic

- Easily removable hydronic heating modules containing 3 row or 4 row hot water coil
- Hot water coils equipped with manual drain and vent valves for flushing water and releasing of trapped air
- Extended water inlet and outlet copper tube connections (3/4" water pipe) for easy installation
- 24VAC color coded din rail mounted terminals for easy thermostat wire connections
- 24VAC output signal for activating field installed water circulating pump or isolation valve
- Factory installed freeze protection to prevent water coil from freezing during non use. Activates water circulation at 40F and deactivates at 60F

10 YEAR FURNACE MODULE REPLACEMENT LIMITED WARRANTY

INSTALLATION DIMENSIONS

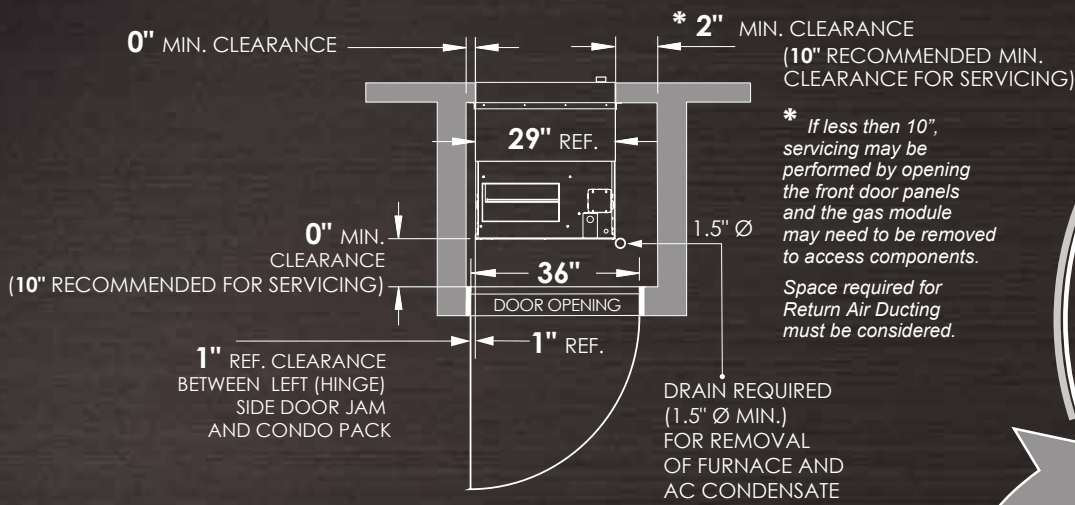

NOTE

** Engineer/Architect - to consult with Napoleon Engineering to determine bracket location for setting the desired depth of Wall Sleeve into wall.

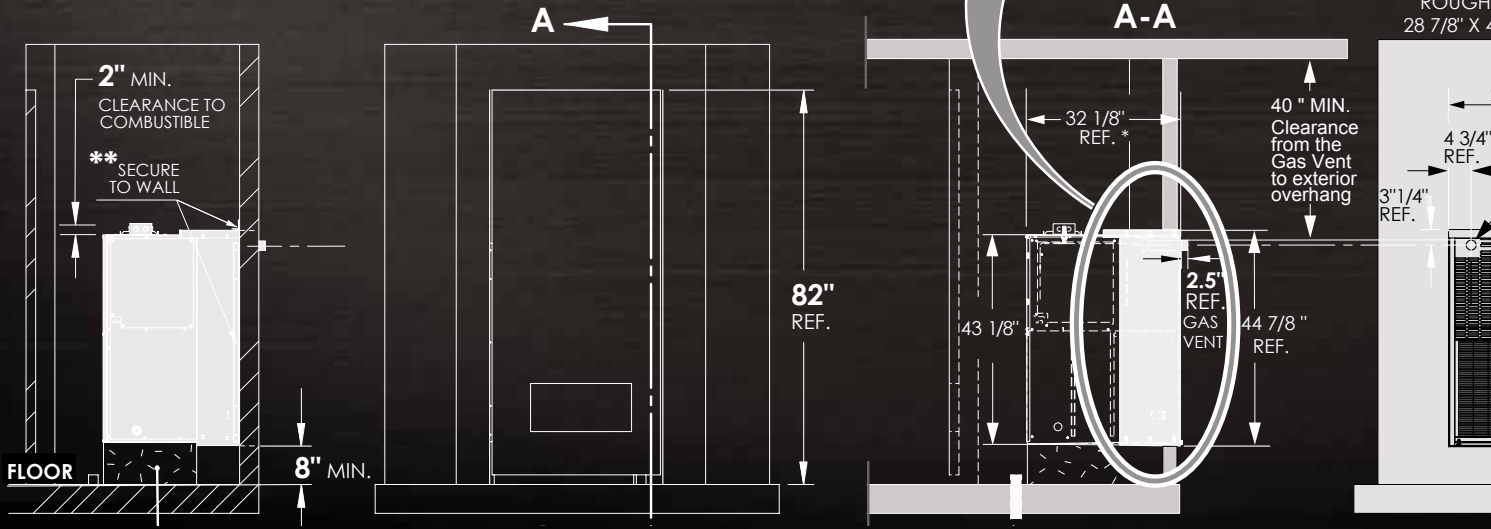

WALL SLEEVE DIMENSIONS

UNIT DIMENSIONS

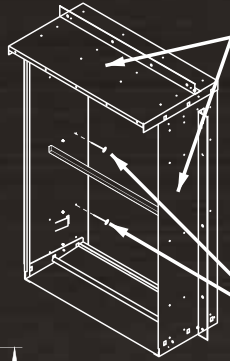

TO IMPROVE RIGIDITY AND REDUCTION IN VIBRATION WALL MOUNTING, BRACKETS CAN BE USED TO AFFIX WALL SLEEVE TO BUILDING SUBSTRUCTURE FROM INSIDE OR OUTSIDE BUILDING. ENGINEER/ARCHITECT TO CONSULT WITH NAPOLEON ENGINEERING TO DETERMINE BRACKET LOCATION FOR SETTING THE DESIRED DEPTH OF WALL SLEEVE INTO WALL.

WALL SLEEVE IS DIRECTLY LAGGED TO WALL SUBSTRUCTURE.

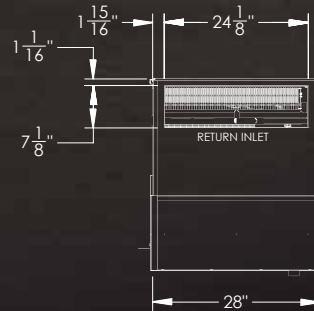
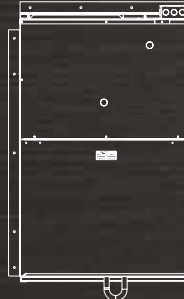
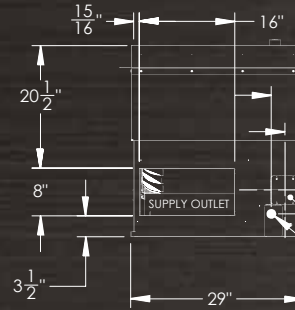
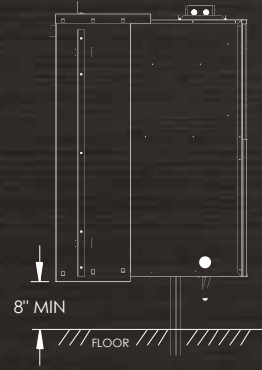
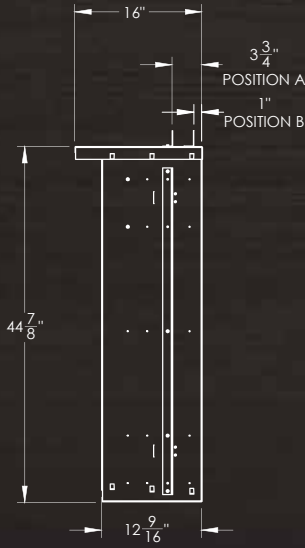
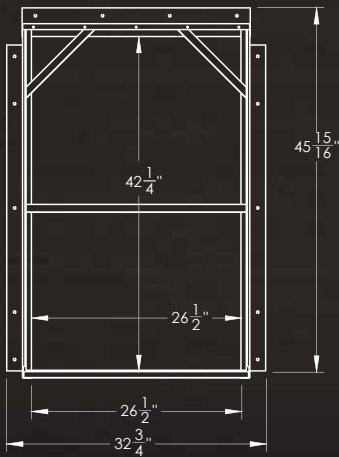
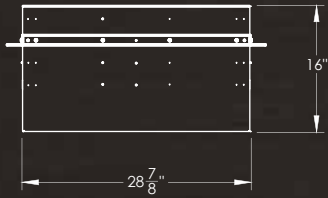



NAPOLEON - CELEBRATING OVER 40 YEARS OF HOME COMFORT PRODUCTS



24 Napoleon Road, Barrie, Ontario, Canada L4M 0G8
103 Miller Drive, Crittenden, Kentucky, USA 41030
7200 Trans Canada Highway, Montreal, Quebec, Canada H4T 1A3

Tel: 866-820-8686 Fax: 705-725-1150
napoleonheatingandcooling.com

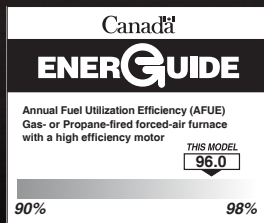

Authorized Dealer

All specifications and designs can change without notice to allow for on-going product improvement. Images may not be exactly as shown. Consult your owners manual for current information. Check all local and national building codes and gas regulations. Napoleon® is a registered trademark of Wolf Steel Ltd. © Wolf Steel Ltd.