

This Owner's Manual is provided and hosted by [Appliance Factory Parts](#).



# FRIGIDAIRE FEC300WH00 Owner's Manual

[Shop genuine replacement parts for FRIGIDAIRE  
FEC300WH00](#)



[Find Your FRIGIDAIRE Evaporative Cooler Parts - Select From 4 Models](#)

----- Manual continues below -----

FRIGIDAIRE

# EVAPORATIVE AIR COOLER

FEC300WH00  
Owner's Manual



**UL** **US**  
**LISTED**  
E219869  
Manual v1.0

# READ AND SAVE THESE INSTRUCTIONS.

## TABLE OF CONTENTS

Register Your Product Online.....	3
Safety Information & Warnings .....	4
Parts List.....	6
Operating Instructions .....	7
Control Panel.....	10
Use Of Remote Control.....	12
Cleaning And Maintenance.....	14
Limited Manufacturer's Warranty.....	15

## SPECIFICATIONS

<b>MODEL NO</b>	FEC300WH00
<b>RATED VOLTAGE</b>	120V
<b>RATED FREQUENCY</b>	60 Hz
<b>RATED POWER</b>	85W
<b>NOISE</b>	40dB - 64dB
<b>MAXIMUM TANK CAPACITY</b>	1.84 Gallons
<b>AIR FLOW</b>	300 CFM
<b>DIMENSIONS (depth× width × height)</b>	10.6"D × 13.6"W × 41.3"H

Frigidaire is a registered trademark of Electrolux Home Products, Inc.  
All rights reserved.

Manufactured under license by:  
NewAir, LLC  
6600 Katella Ave, Cypress, CA 90630  
Comments/questions:  
support@newair.com | 855-963-9247

## REGISTER YOUR PRODUCT ONLINE

### Register Your Frigidaire Product Online Today!

Take advantage of all the benefits product registration has to offer:



**Service and Support**

Diagnose troubleshooting and service issues faster and more accurately



**Recall Notifications**

Stay up to date on safety notices, system updates, and recall notifications



**Special Promotions**

Opt-in for NewAir promotions and offers.

Registering your product information online is safe & secure and takes less than 2 minutes to complete:

[newair.com/register](http://newair.com/register)

Alternatively, we recommend you attach a copy of your sales receipt below and record the following information, which can be found on the manufacturer's nameplate on the back of the unit. You will need this information if it becomes necessary to contact the manufacturer for service inquiries.

**Date of Purchase:**

---

**Serial Number:**

---

**Model Number:**

---

## SAFETY INFORMATION & WARNINGS



Read Rules for Safe Operation and Instructions Carefully.

- Read all instructions before using the fan.
- This appliance has a polarized plug (one blade is wider than the other). To reduce the risk of electric shock, this plug is intended to fit in a polarized outlet only one way. If the plug does not fit fully in the outlet, reverse the plug. If it still does not fit, contact a qualified electrician. Do not attempt to defeat this safety feature.
- **WARNING:** To reduce the risk of fire or electric shock, do not use this fan with any solid-state speed control device.
- Do not leave the fan running unattended.
- Extreme caution is necessary when any heater is used by or near children or those with reduced mental capacity, and whenever the heater is left operating and/or unattended.
- Do not operate any heater with a damaged cord or plug or after the heater malfunctions or been damaged in any manner. Contact a professional operator or contact customer service if any issues arise.
- This appliance is not intended for use by persons (including children) with reduced physical, sensory or mental capabilities, or lack of experience and knowledge, unless they have been given supervision or instruction concerning use of the appliance by a person responsible for their safety. Young children should be supervised to ensure that they do not play with the appliance.
- When the fan was assembled, the rotor blade guard shall not be taken off anymore:
  - Prior to cleaning, unplug the fan.
  - The rotor guard shall not be disassembled/opened to clean the rotor blades.
  - Wipe the fan enclosure and rotor blade guard with a slightly damp cloth.

**RULES FOR SAFE OPERATION**

1. Never insert fingers, pencils, or any other object through the grille when fan is running.
2. Disconnect the fan from the power outlet when moving from it one location to another.
3. Be sure the fan is on a stable surface when operating to avoid overturning.
4. DO NOT use fan near a window, rain may create electrical hazard.
5. Do not use the fan outdoors. Household use only.

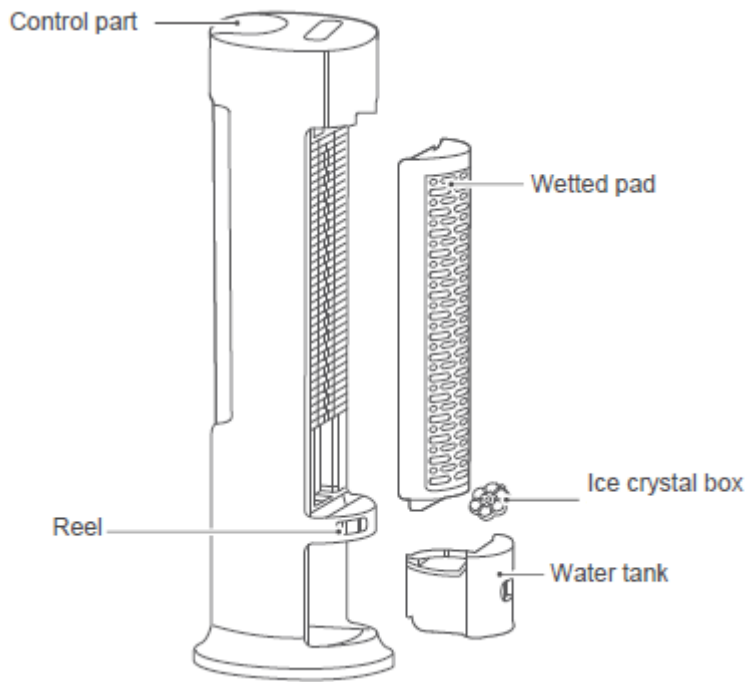
**PARTS LIST**

## OPERATING INTRUCTIONS

Instructions for adding water to the water tank.

### NOTE

- Please clear any remaining water collected at the bottom of the water tank when the machine is not in use.
- When adding water to the tank or cleaning it, the power plug should be removed from the outlet.
- Before you turn on the fan, make sure the pump module is fixed into place.
- There are two ways to add water to the water tank:
  1. Add water directly into the water tank. Make sure that the water pump is properly placed inside.
  2. Add water to the small chamber located above the cooling pad. The water will filter down into the water tank.

Instructions for cleaning the water tank once disassembled.

1. The water tank buckle should be unlocked to the horizontal state.
2. Pumped out any remaining water until the tank is empty. Proceed by pulling out the water tank from the fan.

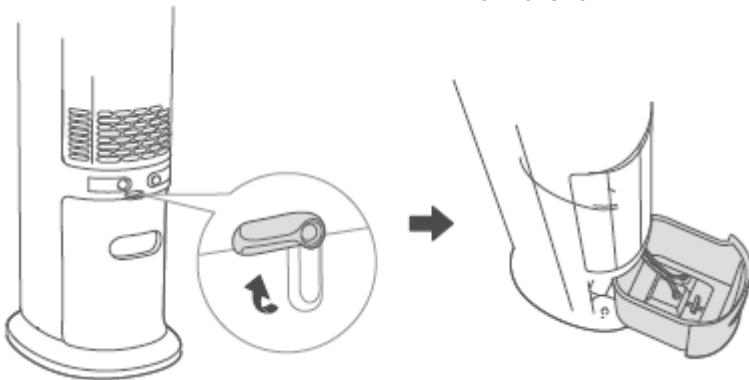

3. Separate the water tank from the pump module (including water tube) by turning the knob 90 degrees counterclockwise.
4. Clean the water tank and replace the water tank to its location at the bottom of the fan.

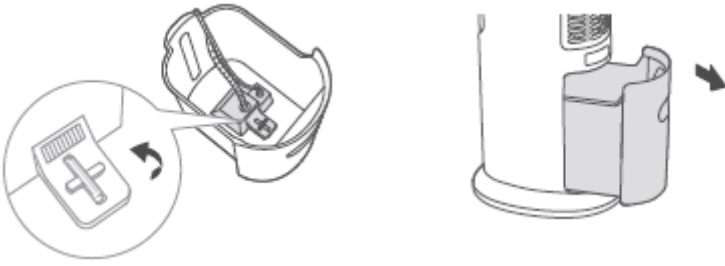

5. Once the water tank is returned to its location, the water pump module should be reattached, and then the water tank buckle should be relocked.

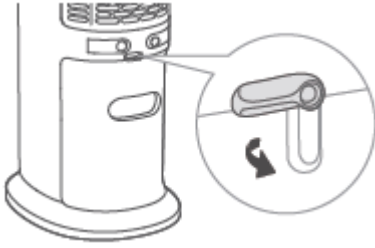

## USE OF ICE CRYSTAL BOX

### NOTE

1. The ice crystal box can be repeatedly frozen and recycled; It also not have to be used if you are satisfied with the fan temperature.
  2. The ice crystal box cover must not be opened to prevent damage.
  3. The ice crystal box material is environmentally friendly, non-toxic and harmless; it can be safely placed in the refrigerator for freezing.
  4. The frozen ice crystal box should be placed in the water tank during use, and after the humidification is turned on, the air outlet temperature will be lowered.
  5. The ice crystal box can be replaced by ice, which also has a cooling effect.
  6. When adding water, the water level of the water tank should not exceed the "MAX" (maximum) indicating scale. If the water level is lower than the "MIN" (minimum) indicating scale, please add water.
- 
1. Pull out the water tank from the bottom of the fan to check the water level.
  2. Remove the ice crystal box from the package and put it in the refrigerator for 3 hours or more. Place the frozen ice crystal box in the water tank and add water. Do not exceeding the "MAX" indicating scale.

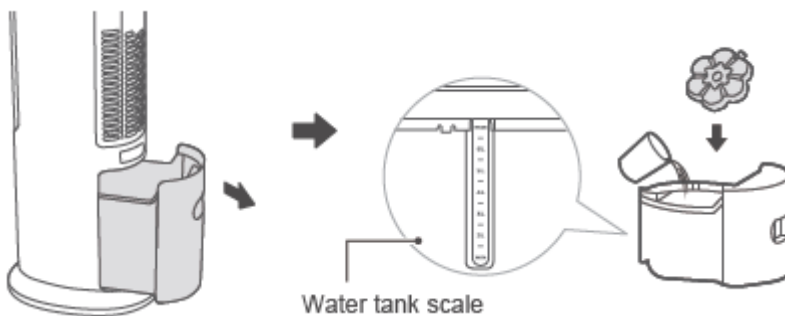





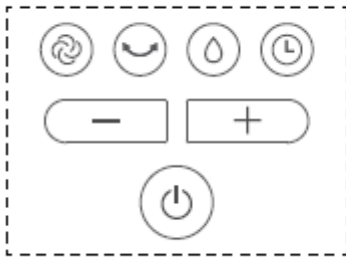

## CONTROL PANEL

Machine body key



Display panel



Key	Function description
	On and Off button.
	Touch the oscillation key to start or stop air rotation.
	Press the humidification button once the fan is on. In the dry or hot weather, start the humidification function to have a better cooling experience.
	There are two fan speeds: Normal (level 3, normal indicator light is lit up), natural (level 2, natural indicator light is lit up).
	When adjusting the fan speed, press the minus or plus buttons to either decrease or increase the fan speed. Use these buttons to also adjust the fan timer. Increase or decrease the timer by .5-hour increments when you set the fan to run between 0-3 hours. If you set the fan to run longer, between 4-10 hours, then you will only be able to increase or decrease the timer by 1-hour increments.
	To set the timer, press the timer button once the device has been turned on. Once the timer icon begins to flash on the display you can use the increase and decrease buttons to set the length of the timer. The icon will flash a total of 6 times to indicate the timer has been set. To cancel timer mode:

	<p>Press the timer button (the icon will start to flash). Press the button one more time to cancel the timer.</p>
--	---

## USE OF REMOTE CONTROL

1. The remote controller can be used normally within the scope of 15 feet and 30 degrees of the deviation angle in front of the product.
2. The battery contains many heavy metals, acid-base and other materials, making it threat to human health if consumed or in contact with skin; Old batteries and battery waste should be disposed of safely.

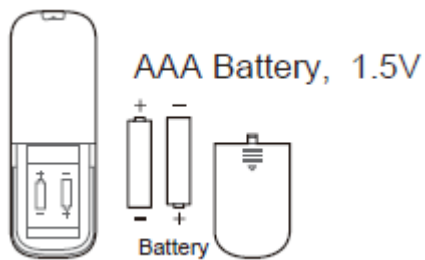
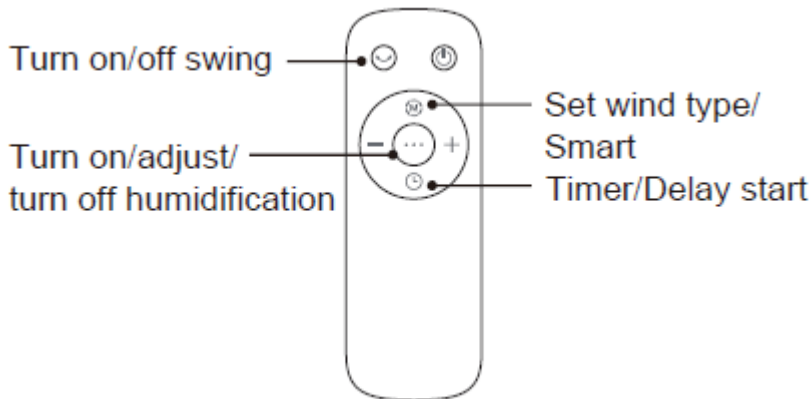

Use manganese or alkaline batteries of type "AAA".DO not use rechargeable batteries.

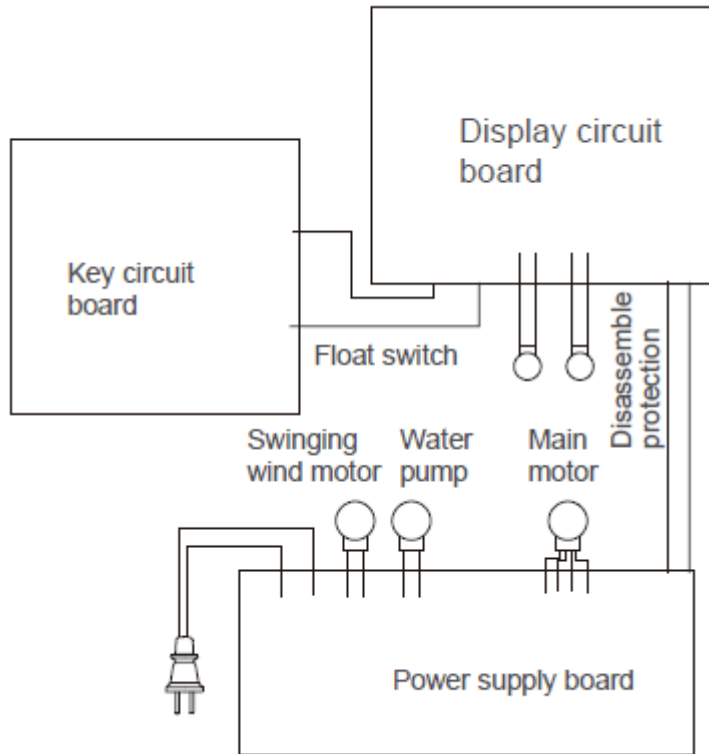
**CIRCUIT DIAGRAM**

## CLEANING AND MAINTENANCE

1. Be sure to unplug the fan from the electrical supply source before cleaning.
2. Plastic parts should be cleaned with mild soap and a damp cloth or sponge. Make sure any remaining soap residue is washed away with clean water before plastic parts are replaced back into the fan.
3. Make sure the plastic parts are completely dry and no water enters the internal structure of the fan.

## LIMITED MANUFACTURER'S WARRANTY

This appliance is covered by a limited manufacturer's warranty. For one year from the original date of purchase, the manufacturer will repair or replace any parts of this appliance that prove to be defective in materials and workmanship, provided the appliance has been used under normal operating conditions as intended by the manufacturer.

### **Warranty Terms:**

During the first year, any components of this appliance found to be defective due to materials or workmanship will be repaired or replaced, at the manufacturer's discretion, at no charge to the original purchaser. The purchaser will be responsible for any removal or transportation costs.

### **Warranty Exclusions:**

The warranty will not apply if damage is caused by any of the following:

- Power failure
- Damage in transit or when moving the appliance
- Improper power supply such as low voltage, defective household wiring or inadequate fuses
- Accident, alteration, misuse or abuse of the appliance such as using non-approved accessories, inadequate air circulation in the room or abnormal operating conditions (extreme temperatures)
- Use in commercial or industrial applications
- Fire, water damage, theft, war, riot, hostility or acts of God such as hurricanes, floods, etc.
- Use of force or damage caused by external influences
- Adjustments to temperature by removal of stickers and/or screws
- Partially or completely dismantled appliances

### **Obtaining Service:**

When making a warranty claim, please have the original bill of purchase with purchase date available. The purchaser will be responsible for any removal or transportation costs. Replacement parts and/or units will be new, remanufactured or refurbished and are subject to the manufacturer's discretion.

For technical support and warranty service, please email [support@newair.com](mailto:support@newair.com)