

This Owner's Manual is provided and hosted by [Appliance Factory Parts](#).



CUISINART CCG-290 Owner's Manual

[Shop genuine replacement parts for CUISINART
CCG-290](#)



[Find Your CUISINART Grill Parts - Select From 152 Models](#)

----- Manual continues below -----

Cuisinart®

Outdoor Grilling Products

18" Kettle Charcoal Grill

Models CCG-290

ASSEMBLY AND OPERATING INSTRUCTIONS

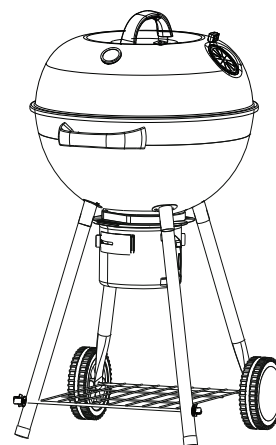

⚠ WARNING: FOR OUTDOOR USE ONLY

⚠ This instruction manual contains important information necessary for the proper assembly and safe use of this grill

⚠ Read and follow all warnings and instructions before assembling and using the grill

⚠ Follow all warnings and instructions when using the grill

⚠ Keep this manual for future reference

Note to installer: Leave this Owner's Manual with the consumer after delivery and/or installation.

Note to customer: Leave this Owner's Manual in a convenient place for future reference.

⚠ DANGER – CARBON MONOXIDE HAZARD

Do Not Use Indoors! Do Not Use Indoors! Burning charcoal releases carbon monoxide gas. If used indoors or in a poorly ventilated area, the gas can accumulate and cause serious injury or death.

⚠ DANGER

Do not use gasoline, alcohol or other flammable liquids to light charcoal. Use only charcoal lighter fluid following the manufacturer's instructions.

⚠ DANGER

Failure to follow these instructions could result in fire, explosion or burn hazard, which could cause property damage, personal injury or death.

⚠ DANGER

1. Never operate this grill unattended.
2. Never operate this grill within 10 feet (3.05m) of any flammable material
3. Never operate this grill with 25 feet (7.5m) of any flammable liquid.
4. If a fire should occur, keep away from the grill and immediately call your fire department . Do not attempt to extinguish an oil or grease fire with water.

⚠ DANGER

Failure to follow these instructions could result in fire, explosion or burn hazard, which could cause property damage, personal injury or death.

Table of Contents

1. Warnings and Safety Instructions	2 – 3
2. Illustrated Parts List and Exploded View Diagram	4
3. Assembly Instructions	6
4. Operating Your Grill	
4.1 Select a Proper Location	9
4.2 Choosing Your Charcoal	9
4.3 Air Vent Operation	9
4.4 Lighting Instructions	9
4.5 When Finished Grilling	11
5. Warranty	11

1. Warnings and Safety Instructions









If these instructions are ignored, there is a possibility of a hazardous fire or explosion which could result in physical injury or property damage! It is your responsibility to assemble, operate and maintain your grill properly.

READ ALL WARNINGS AND INSTRUCTIONS PRIOR TO ASSEMBLING AND OPERATING YOUR GRILL

⚠ WARNINGS

- ⚠ This grill is for outdoor use only. It should NOT be used in a building, garage or any other enclosed area.
- ⚠ The use of alcohol, prescription or non-prescription drugs may impair an individual's ability to properly assemble or safely operate this grill.
- ⚠ Do not leave the grill unattended.
- ⚠ Keep children and pets away from the grill all the times.
- ⚠ Do not use the grill in high wind.
- ⚠ Do not use gasoline, kerosene or alcohol for lighting. Use only charcoal lighter fluid. Follow manufacturer's instructions.
- ⚠ Do not add charcoal lighter fluid or charcoal impregnated with charcoal lighter fluid to hot or warm charcoal.
- ⚠ Do not remove ashes until all charcoal is completely burned out or completely extinguished.
- ⚠ Open the lid while lighting and getting charcoal started.
- ⚠ Always put charcoal on top of the charcoal grate and not directly into the bottom bowl.
- ⚠ Use grill mitts or hot pads to protect hands while adjusting grill vents.
- ⚠ To extinguish coals do not use water. Close vents and lid and wait until grill cools below 115° F (45°C).
- ⚠ Handle and store hot electric starters carefully. Never use charcoal lighter fluid or charcoal impregnated with charcoal lighter fluid with an electric starter. Follow electric starter manufacturer's instructions carefully.
- ⚠ When using lighter fluid always check ash collector before lighting. Fluid can accumulate in the ash collector, resulting in a fire below the bottom bowl. Remove any fluid from ash collector prior to lighting.
- ⚠ Do not attempt to move the grill when in use. Allow the grill to cool to 115 F°(45 C°) before moving or storing.
- ⚠ Do not use the grill unless it is COMPLETELY assembled and all parts are securely fastened and tightened. If there are any missing or damaged parts, contact customer service for a replacement.
- ⚠ Do not alter the grill in any manner.
- ⚠ This grill is not intended to be installed in or on a boat or recreational vehicle.
- ⚠ Locate the grill away from any combustible materials or construction by at least 10 feet in all directions. Never use grill under any overhang or enclosure.
- ⚠ This grill is not intended for and should never be used as a heater.
- ⚠ This grill will be hot during and after use. Use insulated oven mitts or gloves for protection from hot surfaces or splatter from cooking liquids.
- ⚠ This grill is not intended for commercial use.
- ⚠ Combustion by-products produced when using this product contain chemicals known to the state of California to cause cancer, birth defects, or other reproductive harm.

2. Illustrated Parts List and Exploded View

A	23 x 23		4 pcs
B	M6 x 12		8 pcs
C	M5 x 10		4 pcs
D	M6		14 pcs
E	6 x 12		2 pcs
F	6 x 16		12 pcs
G	M10		2 pcs
H	M5		4 pcs
I	M6 x 16		4 pcs

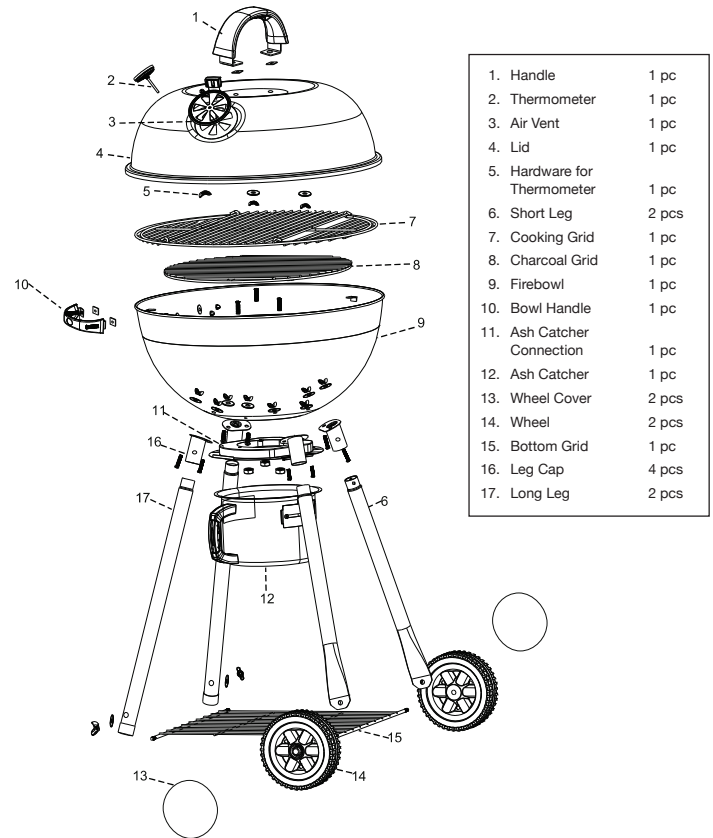

North American Distributor: The Fulham Group, Newton, MA 02466

3. Assembly Instructions

Remove all the contents from packaging, and make sure all parts are present before attempting to assemble!

Step 1:

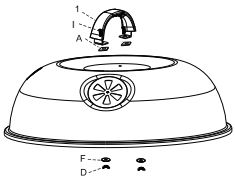

Step 2:

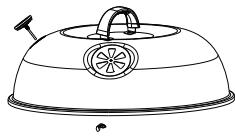

Step 3:

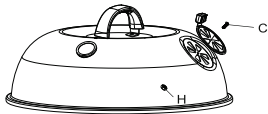

Step 4:

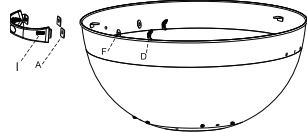

Step 5:

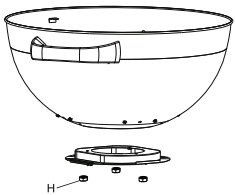

Step 6:

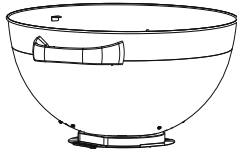

Step 7:

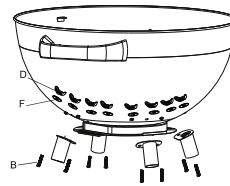

Step 8:

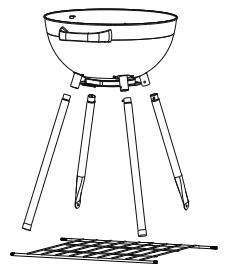

Step 9:

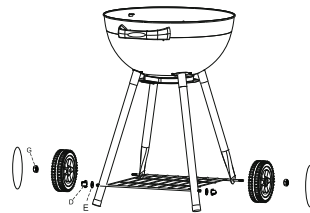

Step 10:

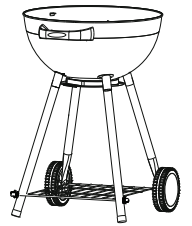

Step 11:

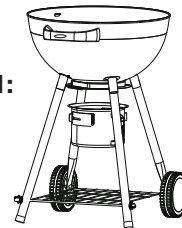

3. Assembly Instructions(cont.)

Step 12:

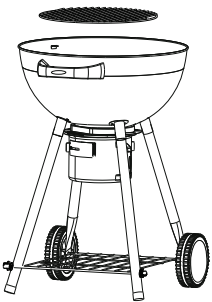

Step 13:

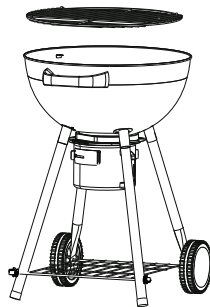

Step 14:

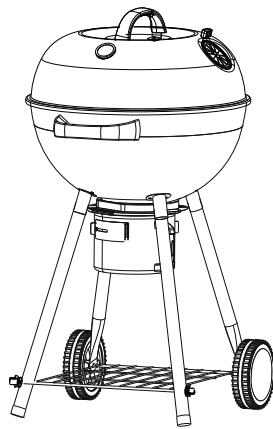
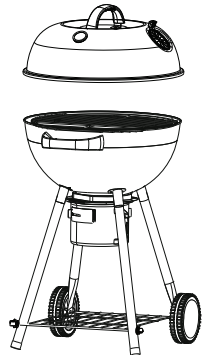

4. Operating Your Grill

4.1 Select a Proper Location

Once you have assembled your new grill, find a suitable location for use.

⚠ DANGER

- Never use this grill inside any building, garage, shed or breezeway, under an overhang or inside any boat, trailer or recreational vehicle, to prevent possible fire and to prevent the possibility of carbon monoxide poisoning or asphyxiation.
- Always place your grill on a hard and level surface far away from combustible materials and structures.
- Do not use this grill under overhead combustible surface or covered area (e.g., awnings, umbrellas, porches or gazeboes). Keep all combustible surfaces at least 10 feet (3 meters) away.
- Locate the grill away from any combustible and non-combustible material or construction by at least 10 feet (3m)
- Never store or use gasoline or other flammable or volatile substances in the vicinity of this grill or in the vicinity of any other heat-generating appliance, because of the danger of starting a fire.
- Do not obstruct the flow of combustion and ventilation air.

4.2 Choosing your charcoal

- We recommend using charcoal briquettes or lump charcoal.
- Adding 3 or 4 lumps of dry hard wood on top of hot coals can provide added smoke flavor.

4.3 Air Vent Operation

Your grill has two airflow control vents; a bottom vent on the ash catcher and an air exhaust vent at the top of the lid. By adjusting the amount of vent opening, you can adjust the temperature of your grill.

⚠ DANGER

- The vents and vent controls and the metal surfaces around them will become very hot during use. Use grill mitts or hot pads to adjust vents when grill is in use.

4.4 Lighting instructions

⚠ DANGER

- Do not use gasoline, kerosene or alcohol for lighting. Use only charcoal lighter fluid. Follow manufacturer's instructions.
- Do not add charcoal lighter fluid or charcoal impregnated with charcoal lighter fluid to hot or warm charcoal.
- Do not overfill charcoal grate. Excess charcoal may cause a fire, or may cause damage to your grill.

1. Read all instructions before lighting.
2. Carefully follow all instructions accompanying charcoal lighter fluid, electric charcoal starters, and or charcoal.

4. Operating Your Grill

3. Fully open air vents on lid and bottom vent.
 4. Ensure that the charcoal grate is in the grill, and positioned properly
 5. Open both vents as described in section 4.3
- Follow electric starter manufacturer's instructions
 - Use caution when removing hot starter

CHIMNEY STARTER

- 1 For best results with a chimney starter, remove cooking grate and set aside.
- 2 Put desired amount of charcoal in chimney starter
- 3 Place crumpled newspaper under the starter and light, being sure to follow the starter manufacturer's instructions
- 4 Carefully pour ignited coals onto charcoal tray, using mitts, gloves, eye protection, and any other protective equipment recommended by the starter manufacturer.
- 5 Replace cooking grate using a grilling mitt or grate lifting tool.

SELF STARTING CHARCOAL

DANGER

- Do not add charcoal lighter fluid or charcoal impregnated with charcoal lighter fluid to hot or warm charcoal.
- Arrange desired amount of charcoal and ignite following manufacturer's instructions

LIGHTER FLUID

DANGER

- Follow all instructions on lighter fluid container.
- When using lighter fluid always check ash collector before lighting. Fluid can accumulate in the ash collector, resulting in a fire below the bottom bowl. Remove any fluid from ash collector prior to lighting.
- Do not add charcoal lighter fluid or charcoal impregnated with charcoal lighter fluid to hot or warm charcoal.

- 1 Place desired coals onto charcoal grate. Arrange as indicated by lighter fluid manufacturer
 - 2 Following lighter fluid manufacturer instructions, apply lighter fluid to charcoal
 - 3 Be sure to allow all lighter fluid to burn off prior to cooking, or noticeable flavors can be added to food
- *Clean your grill after each use. DO NOT use abrasive or flammable cleaners, as it will damage the parts of this product and may start a fire. Clean with warm soapy water.

4. Operating Your Grill

4.5 When Finished Cooking

DANGER

- Never use water to extinguish charcoal.
 - Do not remove ashes until all charcoal is completely burned out or completely extinguished.
1. Close lid, and close both vents.
 2. The charcoal will slowly cool.
 3. Once charcoal is cool, slide out ash collector and dispose into a metal container.

5. Warranty

This warranty covers defects in parts and workmanship for a period of 3 years from the original purchase date. Any damage claim regarding the enameled must be submitted within 30 days of purchase to be covered by the warranty.

The following conditions are NOT covered by this warranty:

- Unevenness and color variations in the enamel coating.
- Damage caused by improper assembly or disregard of the manual.
- Use of spare parts not supplied by manufacturer.
- Damage resulting from modifications or inappropriate use.
- Abuse of the grill
- Damage caused by improper maintenance or repairs by an unauthorized person.

Limitations and exclusions:

1. This warranty applies only to the original purchaser and may not be transferred.
2. If you cannot verify the purchase date of the grill the warranty period will begin on the date the grill was manufactured.
3. Replacement or repair parts are warranted for the remaining period of the original part warranty.

Your obligations:

This grill must be assembled, installed, operated and maintained in accordance with all applicable codes and the instruction manual furnished with this grill. You must keep an invoice, cancelled check or payment record to verify the purchase date of the grill.

 WARNING 	 AVERTISSEMENT 	 ADVERTENCIA 
CALIFORNIA PROPOSITION 65 1. Combustion by-products produced when using this product contain chemicals known to the State of California to cause cancer, birth defects, and other reproductive harm. 2. This product contains chemicals, including lead and lead compounds, known to the State of California to cause cancer, birth defects or other reproductive harm. <i>Wash your hands after handling this product.</i>	PROPOSITION 65 CALIFORNIE 1. Les sous-produits de combustion libérés au cours de l'utilisation de cet appareil contiennent des produits chimiques réputés dans l'Etat de la Californie comme pouvant causer le cancer, des anomalies congénitales et présenter d'autres dangers pour la reproduction. 2. Cet appareil renferme des produits chimiques, y compris du plomb et des composés de plomb, reconnus dans l'Etat de Californie comme étant susceptibles de causer le cancer, des anomalies congénitales, ou autres dangers pour la reproduction. <i>Lavez-vous les mains après avoir manipulé cet appareil.</i>	PROPOSICIÓN 65 DEL ESTADO DE CALIFORNIA 1. En el estado de California se sabe que los subproductos de la combustión, que se producen al usar este producto, contienen sustancias químicas que causan cáncer, defectos congénitos u otras lesiones al aparato reproductor. 2. Este producto contiene sustancias químicas, incluyendo el plomo y compuestos de plomo, que en el estado de California se sabe que las causan cáncer, defectos congénitos u otras lesiones al aparato reproductor. <i>Líquese las manos después de manipular este aparato.</i>

**For customer service please call, email, or write:
1-866-994-6390**

North American Distributor:
The Fulham Group
130 Rumford Ave.
Newton, MA 02466

www.cuisinart.com | grilling@thefulhamgroup.com

Model # CCG-290