

⚠ WARNING

1. High voltage may cause serious injury from electrical shock. Disconnect power to the furnace/air handler before starting installation.
2. Sharp edges may cause injury from cuts. Use care when cutting and handling sheet metal.

⚠ CAUTION

1. To prevent component failure, do not install the air cleaner on the warm air supply or in an area where the temperature may exceed 140°F. This may include areas above heat exchangers in downflow furnaces or above exhaust flues in lowboy furnace cold air returns.
2. Installation must be done by a qualified heating and air conditioning professional. Read instructions thoroughly before beginning installation.
3. Do not install air cleaner downstream of a UV light. UV lamps will cause degradation of the filtering media.

SPECIFICATIONS

MERV (Minimum Efficiency Reporting Value) @ 347 fpm: 13
Airflow Capacity: up to 2000 CFM maximum

Replacement Media: 4200: Model 213 with SelfSeal™
 4400: Model 413 with SelfSeal™

TABLE 1 – Initial Airflow Resistance (inches w.c.)

Model	Airflow (CFM)						
	800	1000	1200	1400	1600	1800	2000
4200	.09	.12	.16	.20	.25	.30	.35
4400	.09	.13	.17	.22	.26	.31	.37

Electrical:

Voltage: 18-30 VAC
 Max Current: 2A (maximum low-voltage current for fan control)

Max. Equipment Weight:

Cabinet will support 400 lb. static load

Air Cleaner and LED Base Operating Environment:

Temperature: 0°F – 140°F
 Humidity: 0-90% non-condensing

Air Cleaner Control Operating Environment:

Temperature: 20°F – 120°F
 Humidity: 0-90% non-condensing

⚠ CAUTION

Do not wire to EAC terminals of HVAC system. These terminals are 120 Volts and will damage the Air Cleaner Control.

DIMENSIONS

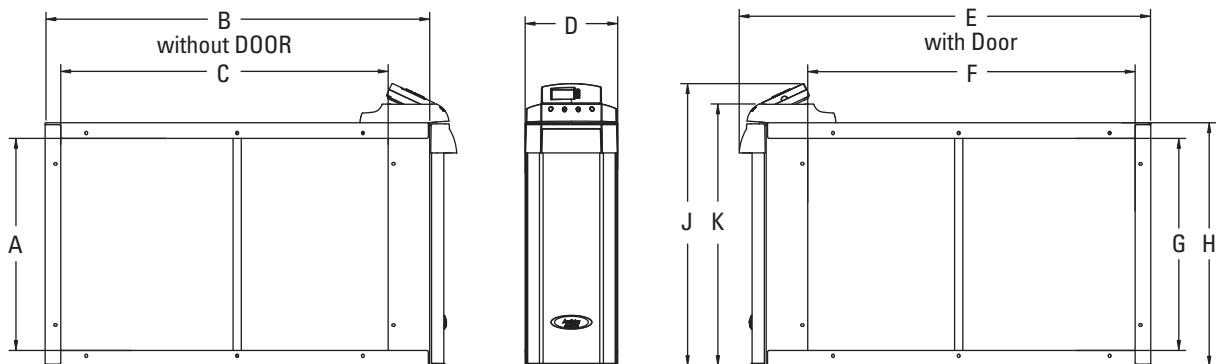

TABLE 2 – Dimensions (inches)

Model	A	B	C	D	E	F	G	H	J	K
4200	19-3/4	25-3/8	21-3/16	6-3/4	27-3/8	21-3/16	19-3/4	22-1/16	27-11/16	23-5/8
4400	15-7/16	28-1/16	23-7/8	6-3/4	30-1/16	23-7/8	15-7/16	17-3/4	23-3/8	19-5/16

90-1333

INSTALL THE AIR CLEANER CABINET

LOCATING THE AIR CLEANER

1. Leave sufficient space in front of the air cleaner for the removal of the filtering media (see **Figure 1**).
2. **DO NOT INSTALL DOWNSTREAM OF A UV LIGHT.** UV lamps will cause degradation of the filtering media.
3. **Figures 2-4** show typical applications. Note position of LED Base.

FIGURE 2 – Horizontal Installation

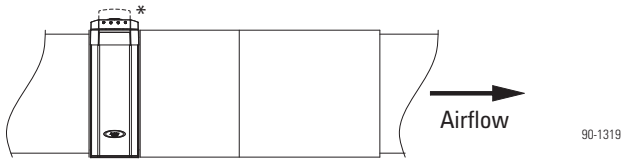

*Leave 4-1/2" above LED Base to allow for installation of the Air Cleaner Control.

FIGURE 3 – Highboy Installation

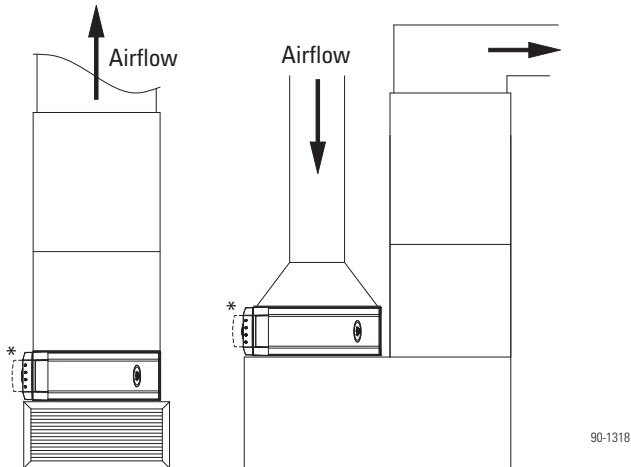

*Leave 4-1/2" above LED Base to allow for installation of the Air Cleaner Control.

FIGURE 4 – Highboy Upflow Installation

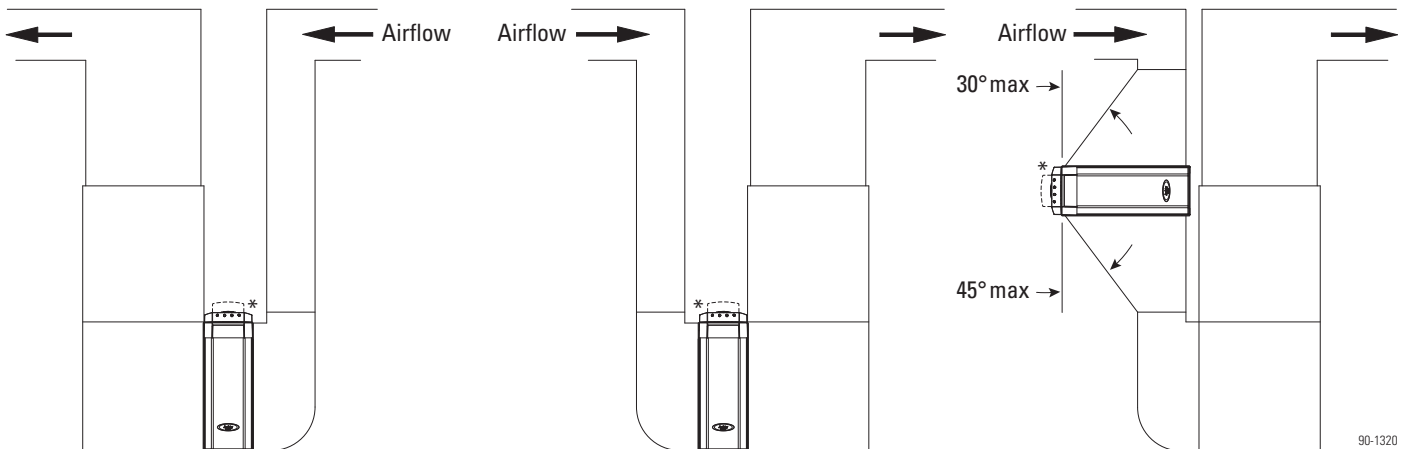

*Leave 4-1/2" above LED Base to allow for installation of the Air Cleaner Control.

FIGURE 1 – Filtering Media Clearance

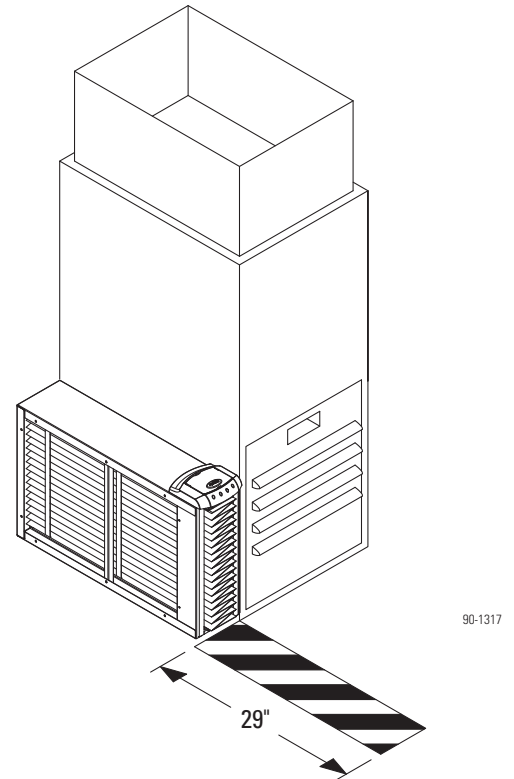

INSTALLATION

1. Disconnect power to the furnace or air handler at the electrical service panel.

WARNING

120 Volts may cause serious injury from electrical shock. Disconnect power to the furnace/air handler before starting installation. Leave power disconnected until installation is completed.

2. Remove the air cleaner door from the outer housing and pull out the filtering media and Air Cleaner Control.
3. If replacing an existing filter, remove the filter and thoroughly clean the blower compartment.
4. Use screws (field supplied) to mount the outer housing to the furnace/air handler.
There is no inlet or outlet side on the outer housing (the outer housing can be mounted on the left or right side of the furnace/air handler), but the **LED Base is to be located at an accessible location.**

NOTE FOR UPFLOW INSTALLATIONS: Provide support under the outer housing to ensure the quality of the seals (see **Figure 5**).

5. Mount the return ductwork to the outer housing.
6. Seal all connections using mastic, foil tape or silicone based caulk.
7. Install the filtering media – use the instructions provided on the cartridge to ensure that it is installed in the proper orientation; the outlet side of the filtering media is the expanded metal.
8. Install the door.

FIGURE 5

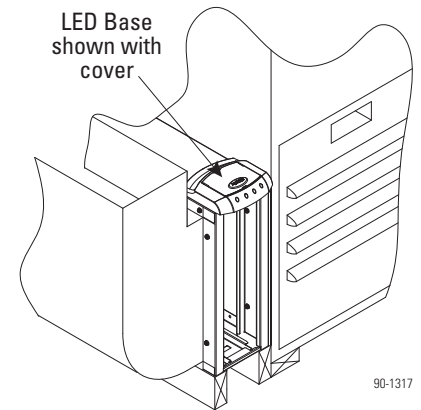

INSTALL THE AIR CLEANER CONTROL

The electronic controls that are included with the air cleaner are used to circulate air through the air cleaner, monitor filter life and inform the user that the air is being cleaned. Users can turn on the blower for a set period of time or adjust it so that the blower is on, either as part of a heating/cooling call or blower only, for a set number of minutes per hour. This requires the Air Cleaner Control to be mounted in an accessible location, and requires 18-22 gauge (standard thermostat cable) wires to be run between the air cleaner components and the HVAC components.

The Air Cleaner Control can be mounted:

- **Option 1:** near the thermostat – see pages 4-5.
- **Option 2:** on the air cleaner in the LED Base, as shown in **Figure 6** – see page 6.
- **Option 3:** near the HVAC equipment – see page 7.

FIGURE 6 – Air Cleaner Control Mounted on the Air Cleaner

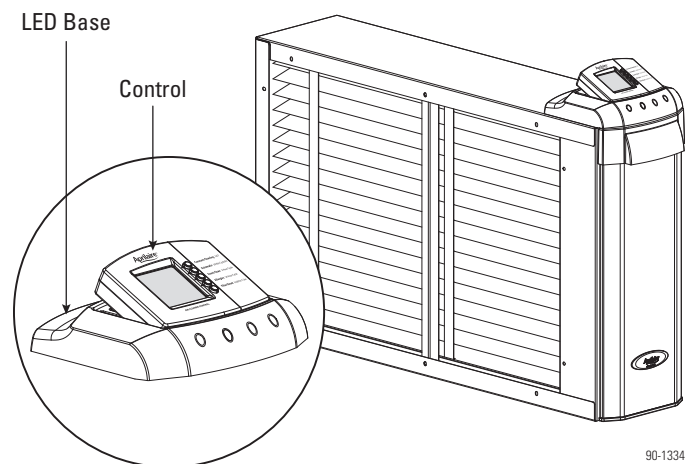

OPTION 1 – INSTALL THE AIR CLEANER CONTROL NEAR THE THERMOSTAT

- 1 Run a 3-conductor cable between the LED Base and the low voltage controls of the HVAC equipment.
- 2 Remove the cover from the LED Base and wire the LED Base to the low voltage controls of the HVAC equipment as shown in **Diagram 1**. Replace the cover on the LED Base.
- 3 Remove the backplate from the Air Cleaner Control and install the backplate near the thermostat. Use the wire opening in the wall behind the thermostat to make sure there is not a wall stud between the thermostat and desired mounting location.
- 4 Run a 5-conductor cable between the thermostat and Air Cleaner Control.
- 5 Wire the thermostat to the Air Cleaner Control as shown in **Diagram 2** or **Diagram 3**. **Diagram 2** is for standard, single thermostat systems; **Diagram 3** is for two-transformer systems such as radiant heat with forced air cooling. Replace the Air Cleaner Control on the backplate.

FIGURE 7

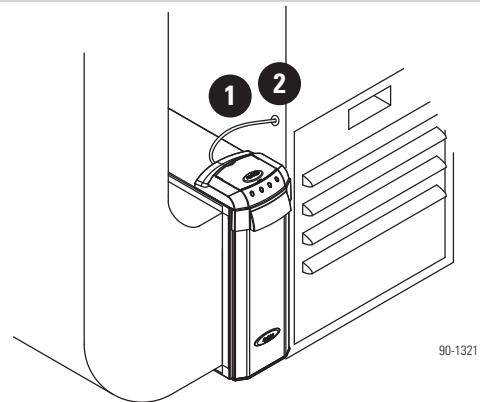

90-1321

FIGURE 8

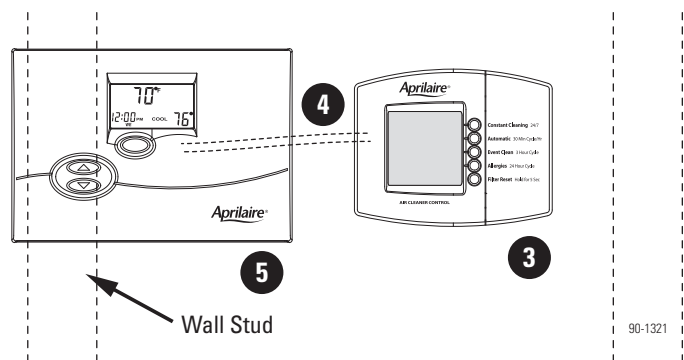

90-1321

DIAGRAM 1 – Wiring the LED Base to the HVAC Equipment

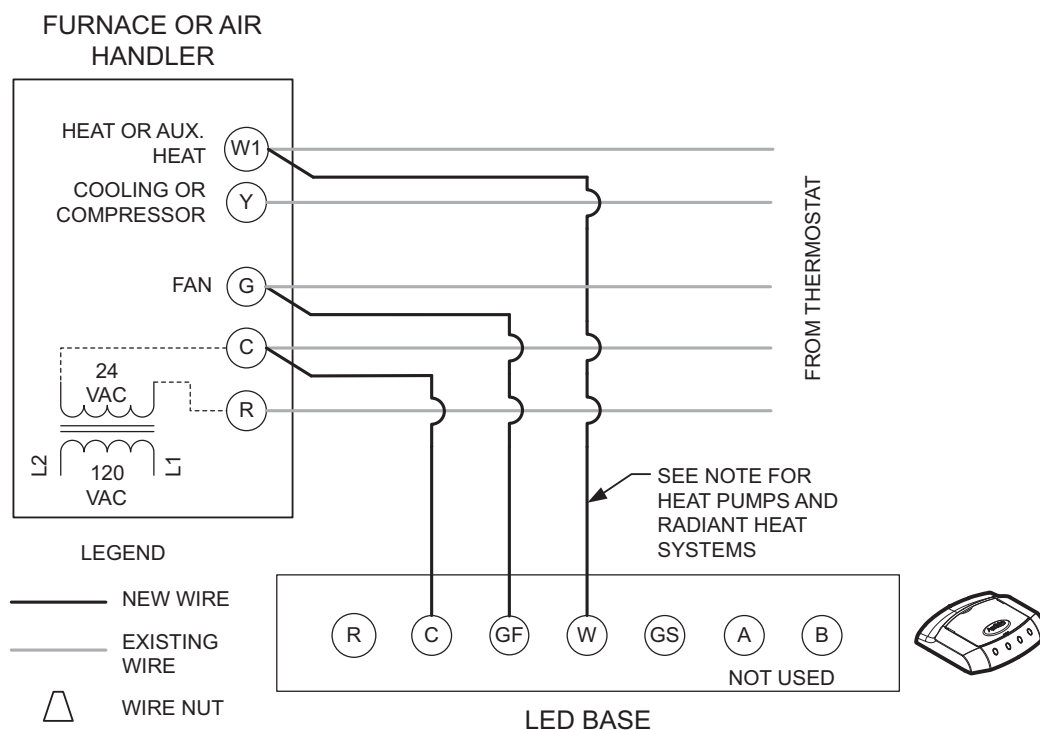

NOTE: IF THERE IS NO AUXILIARY HEAT OR IF THERE IS ONLY RADIANT HEAT, DO NOT WIRE THE EQUIPMENT TO THE W TERMINAL OF THE LED BASE.

90-1328

OPTION 1 – INSTALL THE AIR CLEANER CONTROL NEAR THE THERMOSTAT (CONTINUED)

DIAGRAM 2 – Single Transformer Systems

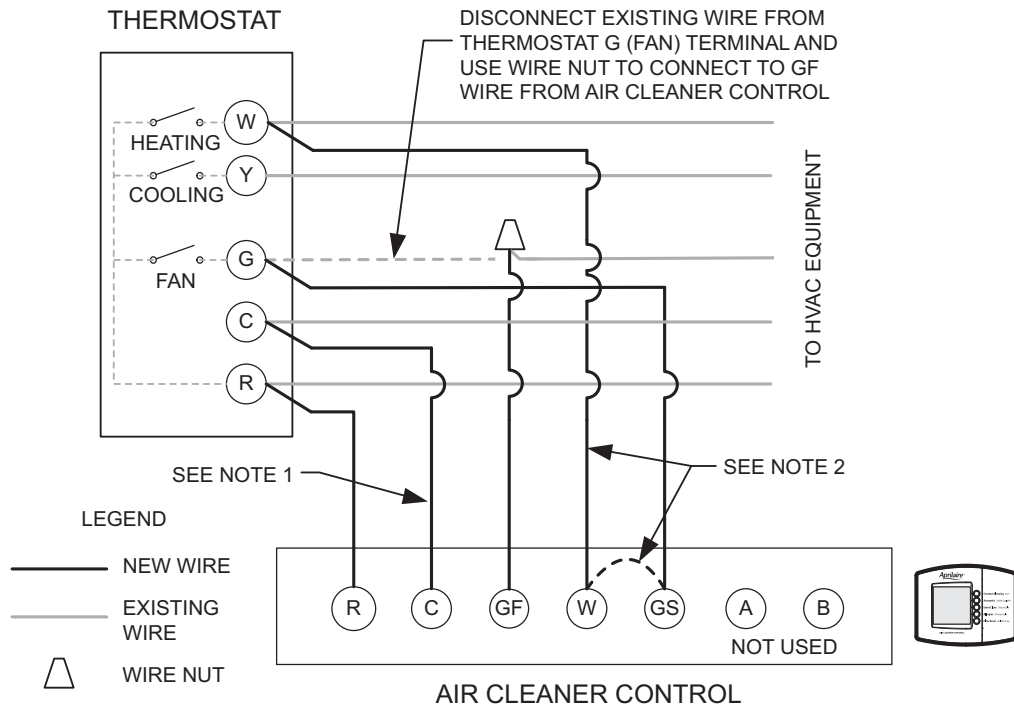

NOTE 1: IF THE TRANSFORMER COMMON IS NOT AVAILABLE, USE THE SUPPLIED BATTERIES TO POWER THE AIR CLEANER CONTROL.

NOTE 2: IF THERE IS NO HEAT OR AUXILIARY HEAT OUTPUT WIRED ON THE THERMOSTAT, JUMPER THE GS AND W TERMINALS ON THE AIR CLEANER CONTROL.

90-1332

DIAGRAM 3 – Two Transformer Systems

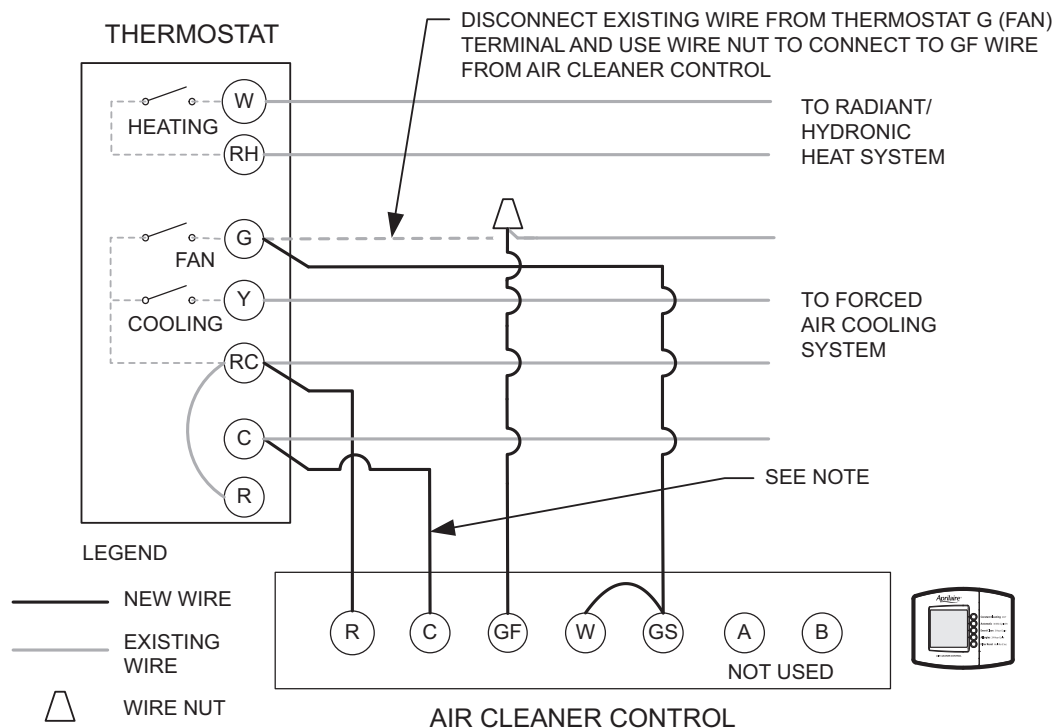

NOTE: IF THE TRANSFORMER COMMON IS NOT AVAILABLE, USE THE SUPPLIED BATTERIES TO POWER THE AIR CLEANER CONTROL. **USE ONLY THE FORCED AIR COOLING SYSTEM TRANSFORMER TO POWER THE AIR CLEANER CONTROL IN TWO TRANSFORMER SYSTEMS.**

90-1331

OPTION 2 – AIR CLEANER CONTROL MOUNTED ON THE AIR CLEANER

- 1 Run a 5-conductor cable between the LED Base and the low voltage controls of the HVAC equipment.
- 2 Remove the cover from the LED Base and wire to the low voltage controls of the HVAC equipment as shown in **Diagram 4**.
- 3 Connect the supplied cable to the Air Cleaner Control and LED Base then slide the Air Cleaner Control into place.

FIGURE 9

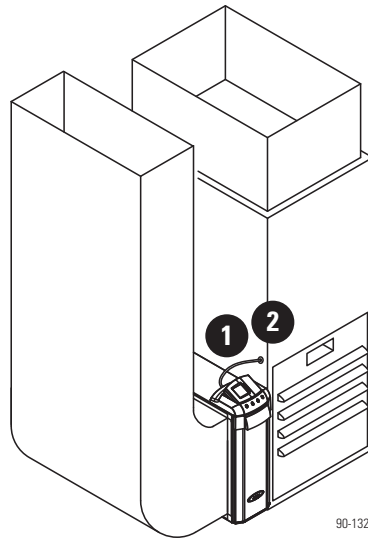

FIGURE 10

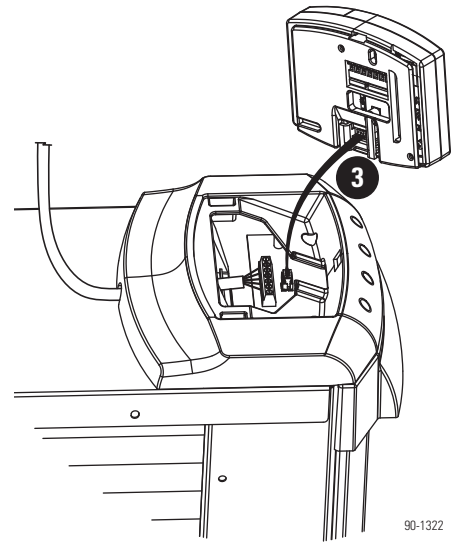
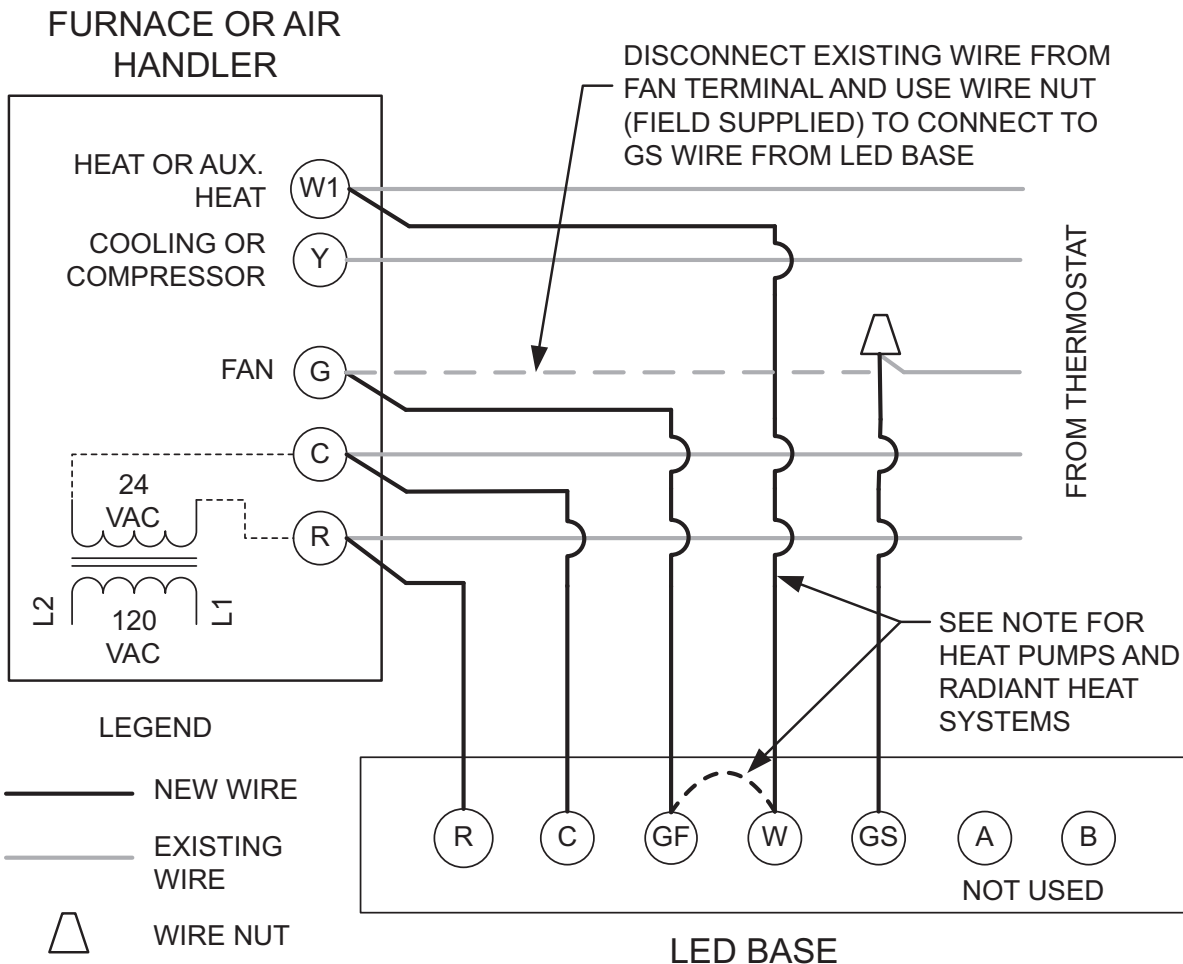

DIAGRAM 4 – Wiring the LED Base to the HVAC Equipment



NOTE: IF THERE IS NO AUXILIARY HEAT OR IF THERE IS ONLY RADIANT HEAT, DO NOT WIRE THE EQUIPMENT TO THE W TERMINAL OF THE LED BASE, AND JUMPER THE GF AND W TERMINALS ON THE LED BASE.

90-1329

OPTION 3 – INSTALL THE AIR CLEANER CONTROL NEAR THE HVAC SYSTEM

- 1 Remove the backplate from the Air Cleaner Control, and install the backplate at the desired location for the Air Cleaner Control. **Do not install the Air Cleaner Control on supply ductwork.**
- 2 Run a 5-conductor cable between the Air Cleaner Control and the LED Base.
- 3 Run a 5-conductor cable between the LED Base and the low voltage controls of the HVAC equipment.
- 4 Remove the cover from the LED Base and wire the Air Cleaner Control to the LED Base as shown in **Diagram 5**. Replace the Air Cleaner Control on the backplate.
- 5 Wire the LED Base to the HVAC equipment as shown in **Diagram 6**. Replace the cover on the LED Base.

FIGURE 11

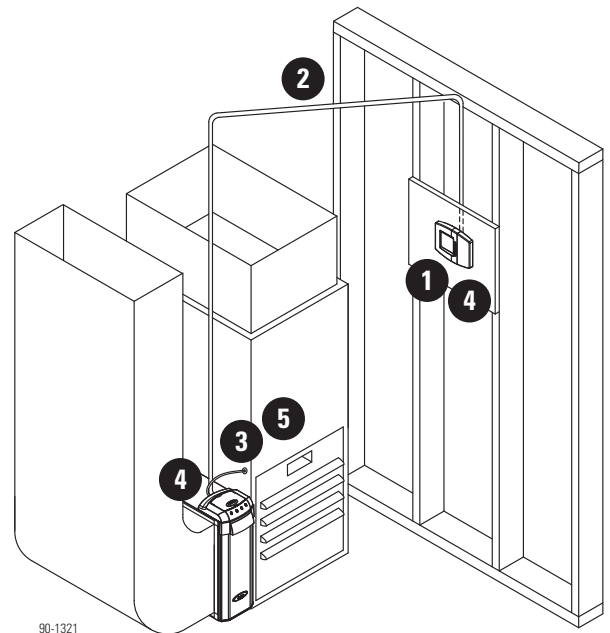

DIAGRAM 5 – Wiring the Air Cleaner Control to the LED Base

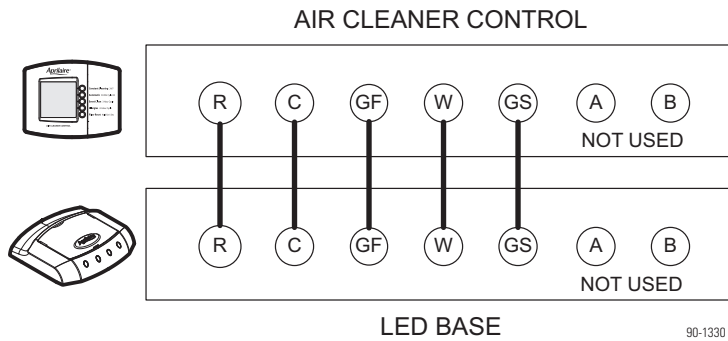
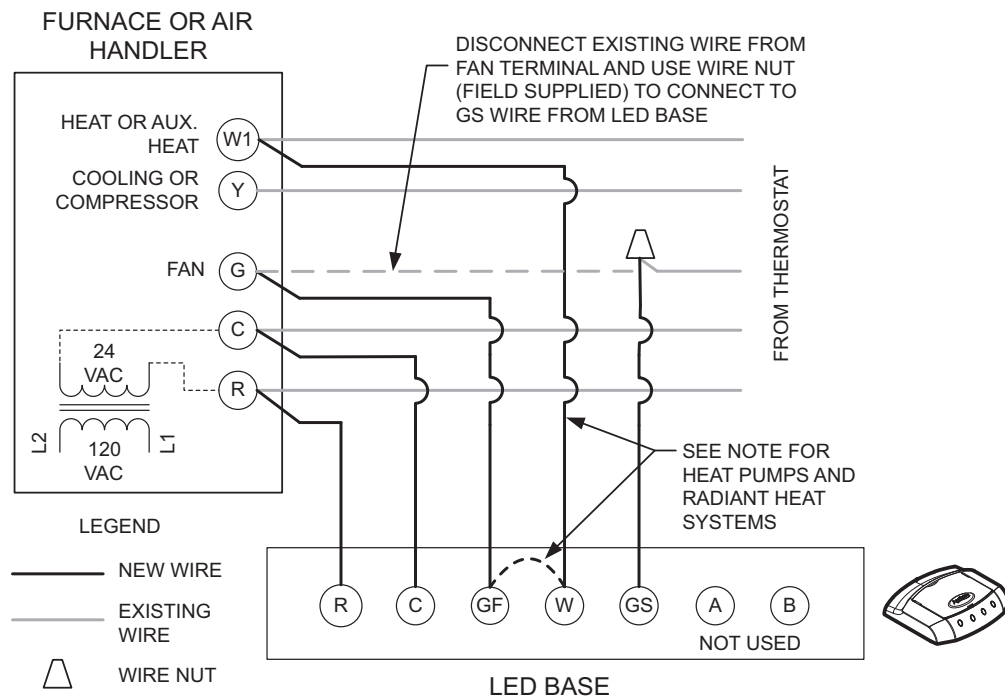

DIAGRAM 6 – Wiring the LED Base to the HVAC Equipment



NOTE: IF THERE IS NO AUXILIARY HEAT OR IF THERE IS ONLY RADIANT HEAT, DO NOT WIRE THE EQUIPMENT TO THE W TERMINAL OF THE LED BASE, AND JUMPER THE GF AND W TERMINALS ON THE LED BASE.

90-1329

INSTALL THE AIR CLEANER CONTROL

SET UP

FILTER LIFE INDICATOR – SETTING THE REPLACEMENT FREQUENCY

Set the jumper on the back of the Air Cleaner Control circuit board, as shown in **Figure 12**, to the desired frequency for filter changes.

TABLE 3 – Filter Change Frequency

Jumper Position	Filter Change Setting
OFF	One calendar year (365 days)
A	6570 hours of use (9 months of continuous blower run time)
B	4380 hours of use (6 months of continuous blower run time)
C	2190 hours of use (3 months of continuous blower run time)

The factory default setting is OFF.

FIGURE 12

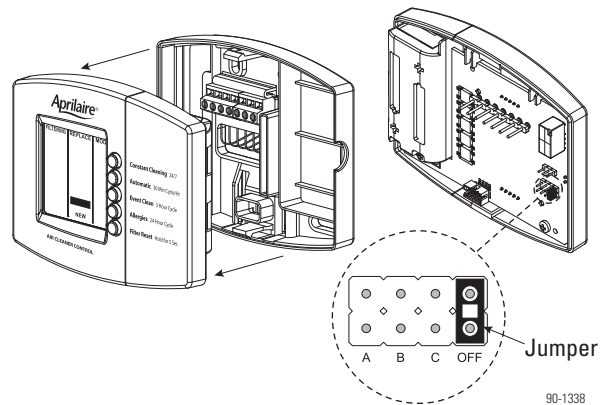

90-1338

START UP

1. Restore power to the HVAC equipment.
2. Set the thermostat mode to OFF and fan to AUTO.
3. The display on the Air Cleaner Control should look like **Figure 13**.
 - Verify that there is no activity in the “FILTERING” portion of the display.
4. Press the “Event Clean” button on the Air Cleaner Control.
 - Verify that the blower starts.
 - Verify that the “FILTERING” portion of the display sequences (**Figure 14**).
 - Verify that the LEDs on the LED base are sequencing on and off (**Figure 15**).
5. Press the “Event Clean” button again to cancel the operation.
6. Return the thermostat Mode and Fan to the desired setting.

Refer to the Owner’s Manual for details on the operation of the Air Cleaner Control.

FIGURE 13

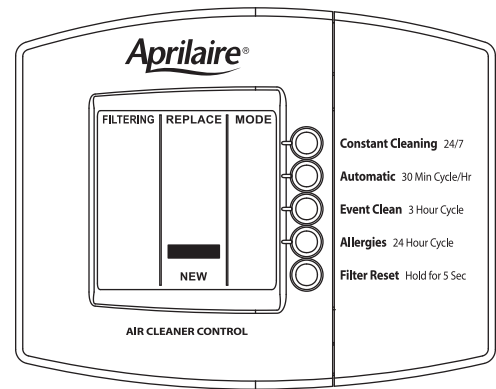

90-1322

FIGURE 14

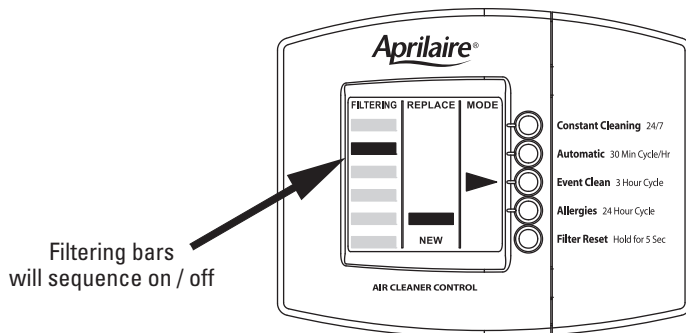

90-1322

FIGURE 15

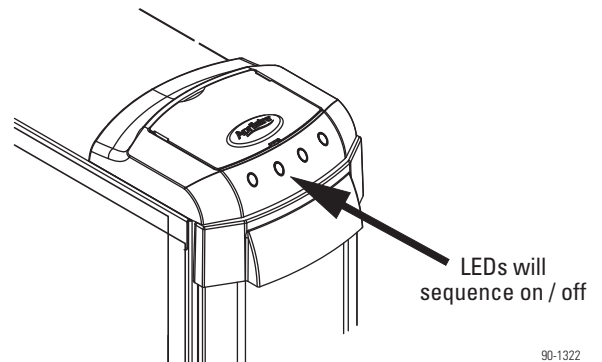

90-1322

RESEARCH PRODUCTS CORPORATION

P.O. Box 1467 • Madison, WI 53701-1467 • Phone: 608/257-8801 • Fax: 608/257-4357 • www.aprilairepartners.com