

This Owner's Manual is provided and hosted by [Appliance Factory Parts](#).



# Monessen Hearth BUF42-T Owner's Manual

[Shop genuine replacement parts for Monessen Hearth  
BUF42-T](#)



[Find Your Monessen Hearth Fireplace Parts - Select From 701 Models](#)

----- Manual continues below -----

WOOD | STONE

**mantels & surrounds**  
BY FIRESIDE FURNISHINGS

Mantels & surrounds **for every décor**  
*Design Series | Signature Series | Select Series*



Mantels & surrounds to fit any style



Battlefield mantel in distressed knotty alder with custom ginger stain and absolute black granite

## Design Series

*As a distinctive selection of mantels, the Design Series is for those with an appreciation for design and craftsmanship who want to stay ahead of today's current trends.*



Kenwood mantel and base with custom paint and new venetian granite

## Signature Series

*Timeless and superior in quality, the broad range of mantels in the Signature Series offer designs with something for every décor.*



## It's in the details

Fireside Furnishings is the premier provider of hearth design solutions for finishing around wood, gas and electric fireplaces. With a broad range of wood mantels and stone selections, the thoughtful details come together to transform a simple fireplace into a beautiful showpiece, and your room into a natural reflection of your dreams, the way you live – your style.

Inspirational ideas for finishing your fireplace can come from all over. Mantels and surrounds by Fireside Furnishings incorporate the best details of traditional, transitional and rustic home furnishing styles.

**TRADITIONAL STYLE** — Inspired by 18th-century, French, English and Italian designs, the traditional finishing options capture the spirit of history in the details.

**TRANSITIONAL STYLE** — Inspired by Arts and Crafts, Mission, cottage, lodge, and Shaker styles, transitional mantel options effortlessly blend designs from the traditional to more contemporary.

**RUSTIC STYLE** — Refreshing simplicity highlighted by natural beauty and rugged charm.

Fireside Furnishings flush wood mantels and shelves are a great value that create a focal point for all rooms. Each is delivered ready to be finished with your choice of paint or stain to perfectly match the personal style and décor of your home.

*Offering an easy way to create a dramatic impact without dramatic cost, the Select Series is the perfect blend of quality, design and value.*

## Select Series



Wescott mantel with custom paint and absolute black granite

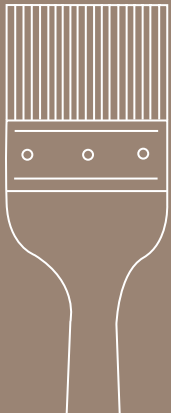

# Why unfinished is **the best solution**

**YOU'RE IN CONTROL** of your color choices from the start.

**TAKES AWAY THE GUESSWORK** of matching décor or current woodwork in your home.

**CUSTOM FINISH IS AVAILABLE** Ask your hearth provider for a quote on the different custom stain options.

## Four steps to customizing your hearth

# 1

### Choose your style

The Design, Signature and Select Series wood mantels are available in traditional, transitional and rustic styles. Easily find the mantel that is perfect for you by browsing through the pages.

# 2

### Pick your mantel ]

Choose from an impressive selection of wood mantel designs available in either primed MDF, unfinished maple or unfinished distressed knotty alder.

# 3

### Match your surround ]

Marble, granite or slate natural stone selections frame your fireplace to ensure safety clearances are met, and to further enhance the beautiful fire.

# 4

### Finish your hearth

Ready to finish. With the limitless stain and paint colors available, you can customize your mantel to perfectly match your décor and current woodwork.



# Wood Species

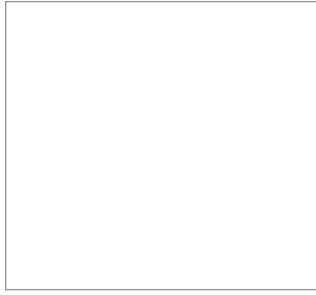

MDF  
PRIMED



MAPLE  
UNFINISHED



DISTRESSED KNOTTY ALDER  
UNFINISHED

# Stone Surrounds

## Design Series



BEIGE



MARRON BROWN MARBLE

## Signature Series



ABSOLUTE BLACK  
GRANITE



GREEN GRANITE



CALEDONIA GRANITE



NEW VENETIAN GRANITE



TAN BROWN GRANITE

## Select Series



SLATE



WHEATFIELD GRANITE

# Stone Sets

The timeless elegance of stone, from the world's finest quarries, is a striking accent to wood mantels. Quality stone facings and hearths are the perfect complement to your fireplace.

SET 1

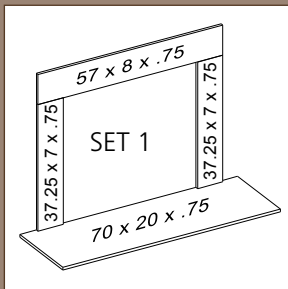

For use with most wood-burning and gas fireplaces

SET 2

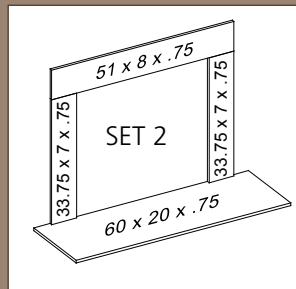

For use with most wood-burning and gas fireplaces

SET 6

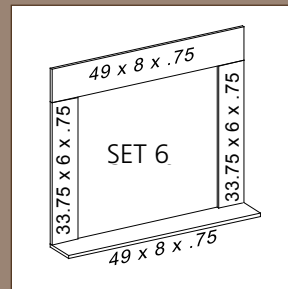

For use with most gas fireplaces

SET 12

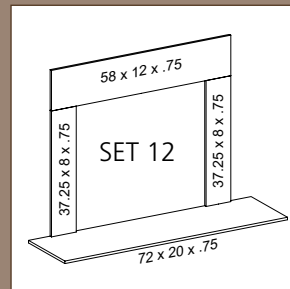

For use when a larger header is required

Stone sets can be cut to fit additional fireplace sizes. Dimensions on all drawings are in inches and for reference only. Please refer to installation manual for detailed specifications on installing this product. Mantel finishes and facing colors are only a representation of the finished look and may not be an exact color match.



# Flush Wood Mantels

Capture your unique style by framing your fireplace with a well-crafted **FLUSH WOOD MANTEL** coordinated with beautiful stone. Create a warm, welcoming space in your home that showcases your style.

Kenwood mantel with custom paint and beige surround

**BELLEVUE** *Design Series*



Available in:

- MDF**  
PRIMED
- MAPLE**  
UNFINISHED

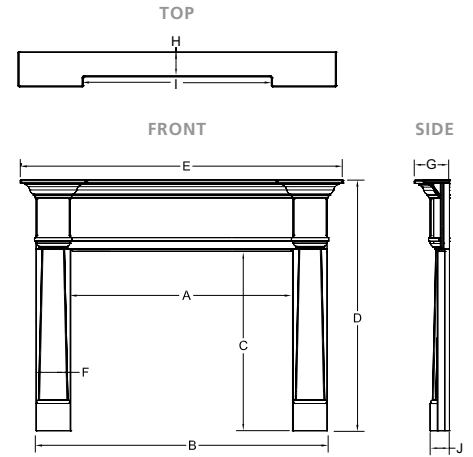

- TRANSITIONAL STYLE
- SHOWN WITH CUSTOM EBONY STAIN AND CALEDONIA GRANITE

Bellevue	A OPENING WIDTH	B OUTSIDE WIDTH	C OPENING HEIGHT	D OUTSIDE HEIGHT	E TOP WIDTH	F LEG WIDTH	G OUTSIDE SHELF DEPTH	H SHELF INSET DEPTH	I SHELF INSET WIDTH	J LEG DEPTH	K RECOMMEN SET SIZE
B SIZE	48"	64"	39-1/2"	55-1/4"	71"	6-1/2"	7-3/4"	5-1/2"	42"	3-3/4"	1
C SIZE	53"	69"	42"	57-3/4"	76"	6-1/2"	7-3/4"	5-1/2"	47"	3-3/4"	1

**BATTLEFIELD** *Design Series*



Available in:

- MDF**  
PRIMED
- MAPLE**  
UNFINISHED
- DISTRESSED  
KNOTTY ALDER**  
UNFINISHED

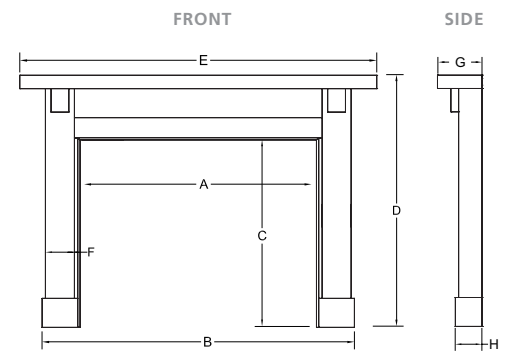

- RUSTIC STYLE
- SHOWN WITH CUSTOM GINGER STAIN AND NEW VENETIAN GRANITE

Battlefield	A OPENING WIDTH	B OUTSIDE WIDTH	C OPENING HEIGHT	D OUTSIDE HEIGHT	E TOP WIDTH	F LEG WIDTH	G SHELF DEPTH	H LEG DEPTH	I RECOMMEN SET SIZE
B SIZE	48"	65"	39-1/2"	54"	75"	6-1/2"	9"	5-1/4"	1
C SIZE	53"	70"	42"	56-1/2"	80"	6-1/2"	9"	5-1/4"	1

**PORTICO** *Design Series*



*Available in:*

**MDF**  
PRIMED

**MAPLE**  
UNFINISHED

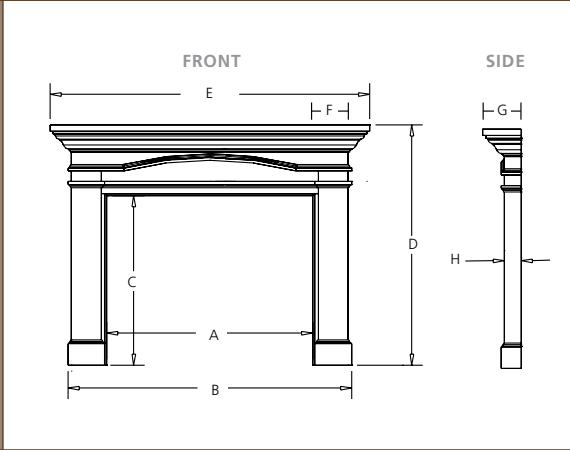

- TRANSITIONAL STYLE
- PORTICO MANTEL SHOWN WITH CUSTOM NATURAL STAIN AND MARRON BROWN MARBLE

Portico	A OPENING WIDTH	B OUTSIDE WIDTH	C OPENING HEIGHT	D OUTSIDE HEIGHT	E TOP WIDTH	F LEG WIDTH	G SHELF DEPTH	H LEG DEPTH	I RECOMMEND SET SIZE
B SIZE	48"	66"	39-1/2"	56"	74-1/2"	8-1/2"	9"	4"	1
C SIZE	53"	70"	42"	59"	78-1/2"	8"	9"	4"	1

**ACADIA** *Signature Series*



*Available in:*

**MDF**  
PRIMED

**MAPLE**  
UNFINISHED

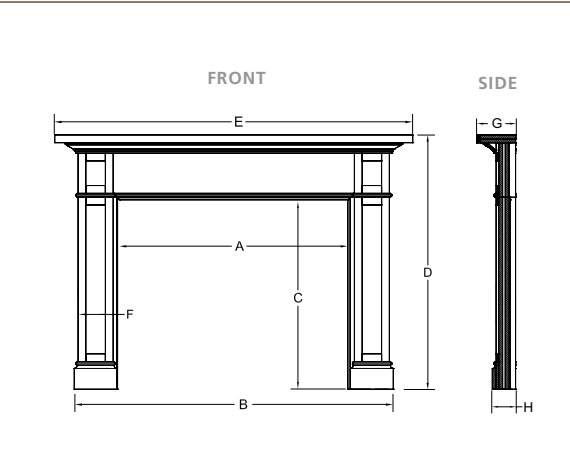

- TRADITIONAL STYLE
- SHOWN WITH CUSTOM PAINT AND SLATE

Acadia	A OPENING WIDTH	B OUTSIDE WIDTH	C OPENING HEIGHT	D OUTSIDE HEIGHT	E TOP WIDTH	F LEG WIDTH	G SHELF DEPTH	H LEG DEPTH	I RECOMMEND SET SIZE
A SIZE	44"	61-1/2"	36-1/2"	49"	69"	6-3/4"	7-1/2"	3-3/4"	1
B SIZE	48"	65-1/2"	39-1/2"	52"	73"	6-3/4"	7-1/2"	3-3/4"	1
C SIZE	53"	70"	42"	54-1/2"	78"	6-3/4"	7-1/2"	3-3/4"	12

## KENWOOD Signature Series



- TRANSITIONAL STYLE
- SHOWN WITH IN CUSTOM PAINT AND ABSOLUTE BLACK GRANITE

Available in:

**MDF**  
PRIMED

**MAPLE**  
UNFINISHED

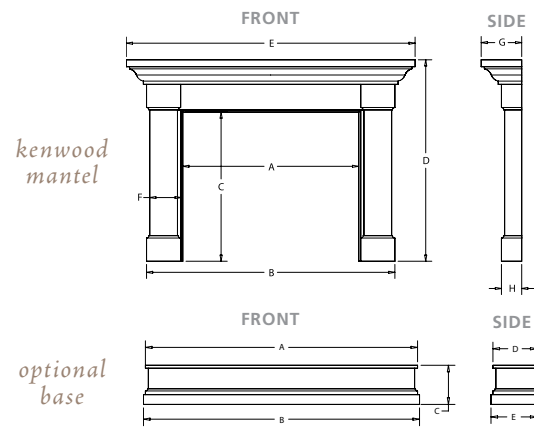

Optional Base	A TOP WIDTH	B BOTTOM WIDTH	C HEIGHT	D TOP DEPTH	E BOTTO DEPTH
A SIZE	62-3/4"	63-3/4"	10"	11-1/4"	11-3/4"
B SIZE	69-1/2"	70-1/2"	10"	11-1/4"	11-3/4"
C SIZE	74"	75"	10"	11-1/4"	11-3/4"

Kenwood (Without Base)	A OPENING WIDTH	B OUTSIDE WIDTH	C OPENING HEIGHT	D OUTSIDE HEIGHT	E TOP WIDTH	F LEG WIDTH	G SHELF DEPTH	H LEG DEPTH	I RECOMMEN SET SIZE
A SIZE	44"	60"	36-1/2"	48-3/4"	69-1/2"	8"	9-3/4"	5"	6
B SIZE	48"	65"	39-1/2"	51-3/4"	74-1/2"	8"	9-3/4"	5"	1
C SIZE	53"	70"	42"	54-1/4"	79-1/2"	8"	9-3/4"	5"	1
B60 SIZE	46"	60"	39-1/2"	51-5/8"	67-1/2"	5"	8-1/2"	4"	2

## ROXBOROUGH Signature Series



- TRADITIONAL STYLE
- SHOWN WITH CUSTOM PAINT AND CALEDONIA GRANITE

Available in:

**MDF**  
PRIMED

**MAPLE**  
UNFINISHED

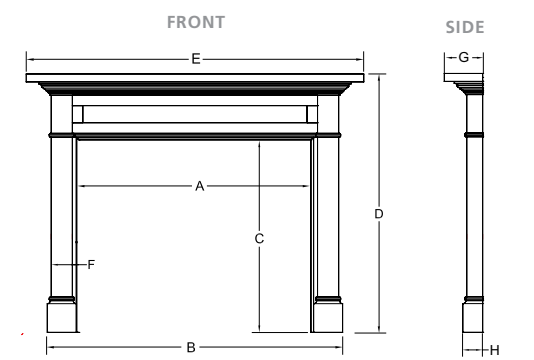

Roxborough	A OPENING WIDTH	B OUTSIDE WIDTH	C OPENING HEIGHT	D OUTSIDE HEIGHT	E TOP WIDTH	F LEG WIDTH	G SHELF DEPTH	H LEG DEPTH	I RECOMMEN SET SIZE
A SIZE	44"	56"	36-1/2"	49"	64"	4"	7-1/4"	3"	2
B SIZE	48"	60"	39-1/2"	52"	68"	4"	7-1/4"	3"	2
C SIZE	53"	65"	42"	54-1/2"	73"	4"	7-1/4"	3"	1

## WESCOTT *Select Series*



- TRANSITIONAL STYLE
- SHOWN WITH CUSTOM PAINT AND GREEN GRANITE

Available in:

**MDF**  
PRIMED

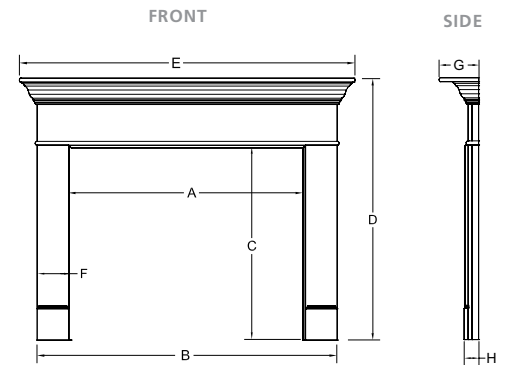

Wescott	A OPENING WIDTH	B OUTSIDE WIDTH	C OPENING HEIGHT	D OUTSIDE HEIGHT	E TOP WIDTH	F LEG WIDTH	G SHELF DEPTH	H LEG DEPTH	I RECOMMEN SET SIZE
A SIZE	44"	57"	36-1/2"	49-3/4"	63-3/4"	6"	7-1/2"	2-3/4"	2
B SIZE	48"	60"	39-1/2"	52-3/4"	66-3/4"	5-1/2"	7-1/2"	2-3/4"	2
C SIZE	53"	66"	42"	55-1/4"	72-1/2"	6"	7-1/2"	2-3/4"	1

## RICHLAND *Select Series*



- TRANSITIONAL STYLE
- SHOWN WITH CUSTOM PAINT AND TAN BROWN GRANITE

Available in:

**MDF**  
PRIMED

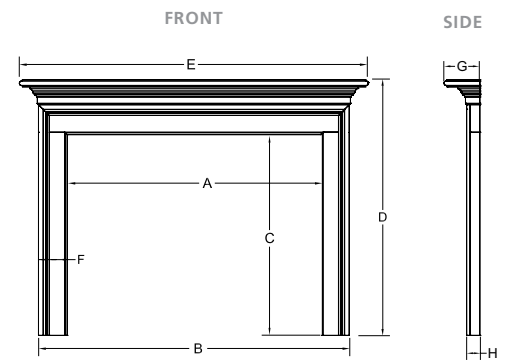

Richland	A OPENING WIDTH	B OUTSIDE WIDTH	C OPENING HEIGHT	D OUTSIDE HEIGHT	E TOP WIDTH	F LEG WIDTH	G SHELF DEPTH	H LEG DEPTH	I RECOMMEN SET SIZE
RS SIZE	44"	55"	36-1/2"	48"	60"	5"	7-1/2"	2-3/4"	6
A SIZE	44"	56"	36-1/2"	48"	64"	5-1/2"	7-1/2"	2-3/4"	6
B SIZE	48"	60"	39-1/2"	49-1/4"	68"	5-1/2"	7-1/2"	2-3/4"	6
C SIZE	53"	65"	42"	53-1/2"	73"	5-1/2"	7-1/2"	2-3/4"	2



# Wood Shelf Mantels

The **SHELF MANTEL** is the perfect accent to a brick fireplace and a place to showcase some of your most cherished mementos. Available either in 48, 59 or 72-inch lengths.\*

Ozark shelf with custom ebony stain

*\*most shelf mantels are in 48", 59" or 72"*

## OZARK *Design Series*



- RUSTIC STYLE
- SHOWN WITH CUSTOM EBONY STAIN
- AVAILABLE IN 48", 59" AND 72" WIDTHS

Available in:

MDF  
PRIMED

MAPLE  
UNFINISHED

DISTRESSED  
KNOTTY ALDER  
UNFINISHED

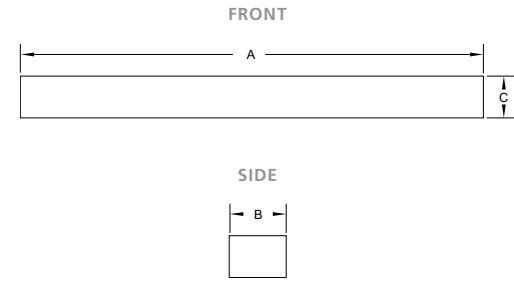

Ozark	A WIDTH	B SHELF DEPTH	C SHELF HEIGHT
SIZE	48"	8"	5"
SIZE	59"	8"	5"
SIZE	72"	8"	5"

## GIFFORD *Signature Series*



- TRANSITIONAL STYLE
- SHOWN WITH CUSTOM PAINT
- AVAILABLE IN 48", 59" AND 72" WIDTHS

Available in:

MDF  
PRIMED

MAPLE  
UNFINISHED

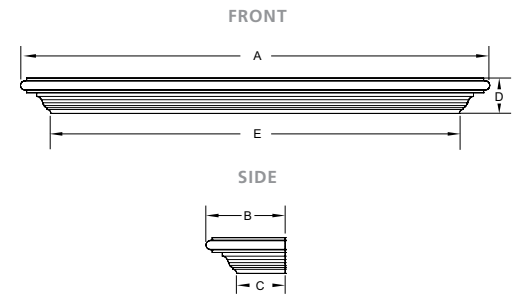

Gifford	A WIDTH	B SHELF DEPTH	C DEPTH	D HEIGHT	E BOTTOM WIDTH
SIZE	48"	8"	4-3/4"	3-5/8"	41-1/2"
SIZE	59"	8"	4-3/4"	3-5/8"	52-1/2"
SIZE	72"	8"	4-3/4"	3-5/8"	65-1/2"

## FILLMORE *Select Series*



- TRADITIONAL STYLE
- SHOWN WITH CUSTOM EBONY STAIN
- AVAILABLE IN 48", 59" AND 72" WIDTHS

Available in:

MDF  
PRIMED

MAPLE  
UNFINISHED

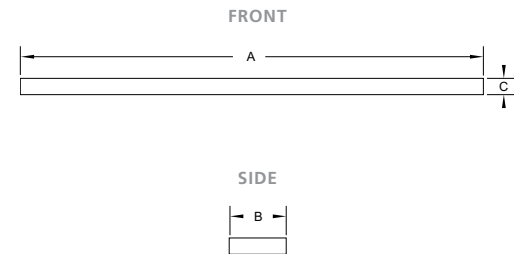

Fillmore	A WIDTH	B SHELF DEPTH	C HEIGHT
SIZE	48"	8"	2-1/2"
SIZE	59"	8"	2-1/2"
SIZE	72"	8"	2-1/2"

## CORBELS



- ADDED SUPPORT AND STYLE FOR ANY FIRESIDE FURNISHINGS SHELF
- SHOWN WITH CUSTOM NATURAL STAIN

Available in:

MDF  
PRIMED

MAPLE  
UNFINISHED

DISTRESSED  
KNOTTY ALDER  
UNFINISHED

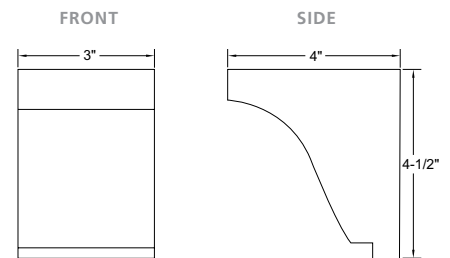



# Wood Cabinets

Don't be afraid to think beyond the traditional flush fireplace installation. A **CORNER OR FLAT WALL CABINET** is a great way to mix it up. Frame your fireplace perfectly and add a more dramatic look to your room.

Kenwood corner cabinet with optional base, custom paint and absolute black granite

## KENWOOD CORNER CABINET *Signature Series*



Available in:

**MDF**  
PRIMED

**MAPLE**  
UNFINISHED

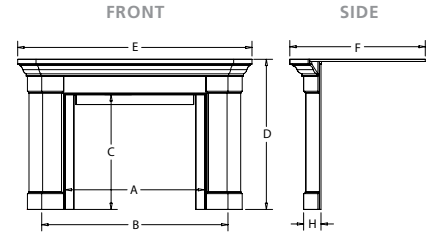
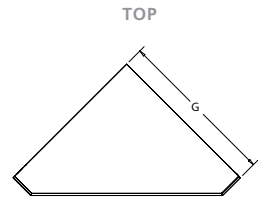

- TRANSITIONAL STYLE
- SHOWN WITH CUSTOM PAINT AND CALEDONIA GRANITE

Kenwood Corner (Without Base)	A OPENING WIDTH	B OUTSIDE WIDTH	C OPENING HEIGHT	D OUTSIDE HEIGHT	E TOP WIDTH	F TOP DEPTH	G SHELF DEPTH (ALONG WALL)	H LEG DEPTH	I RECOMMEN SET SIZE
43HB	43"	58-1/2"	38-1/4"	50-1/2"	71-11/16"	40-5/32"	50-11/16"	6-1/8"	6
44SB	42"	59-1/8"	36-1/2"	48-11/16"	74-21/32"	43-5/8"	52-25/32"	8-29/32"	6
48DB	48"	60"	39-1/2"	51-11/16"	80-21/32"	46-5/8"	57-1/32"	8-29/32"	6

## KENWOOD CORNER CABINET OPTIONAL BASE *Signature Series*



Available in:

**MDF**  
PRIMED

**MAPLE**  
UNFINISHED

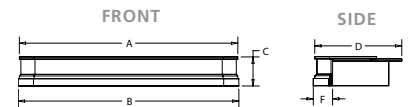
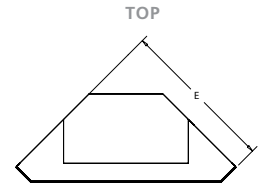

- TRANSITIONAL STYLE
- SHOWN WITH CUSTOM PAINT AND ABSOLUTE BLACK GRANITE

Kenwood Corner Optional Base	A TOP WIDTH	B BOTTOM WIDTH	C HEIGHT	D TOP DEPTH	E SHELF DEPTH (ALONG WALL)	F BASE RETURN
43HB	67-3/32"	67-13/16"	10"	26"	47-7/16"	4-31/32"
44SB	69-13/16"	70-1/2"	10"	30"	49-3/8"	7-3/4"
48DB	75-13/16"	76-1/2"	10"	30"	53-19/32"	7-3/4"

## KENWOOD WALL CABINET *Signature Series*



Available in:

**MDF**  
PRIMED

**MAPLE**  
UNFINISHED

FRONT

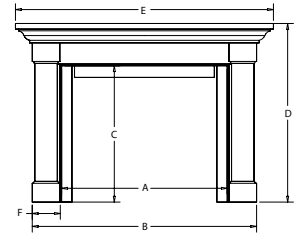

SIDE



- TRANSITIONAL STYLE
- SHOWN WITH CUSTOM PAINT AND MARRON BROWN MARBLE

Kenwood Wall Cabinet	A OPENING WIDTH	B OUTSIDE WIDTH	C OPENING HEIGHT	D OUTSIDE HEIGHT	E TOP WIDTH	F LEG WIDTH	G SHELF DEPTH	H LEG DEPTH	I RECOMMEN SET SIZE
43HB	43"	60"	38-1/4"	50-1/2"	69-3/4"	8"	29-5/8"	24-3/4"	6
44SB	42"	59"	36-1/2"	48-3/4"	68-3/4"	8"	26-7/8"	22"	6
48SB	48"	65"	39-1/2"	51-3/4"	74-3/4"	8"	26-7/8"	22"	6
48DB	48"	65"	39-1/2"	51-3/4"	74-3/4"	8"	31-5/8"	26-3/4"	6

## KENWOOD WALL CABINET OPTIONAL BASE *Signature Series*



Available in:

**MDF**  
PRIMED

**MAPLE**  
UNFINISHED

FRONT

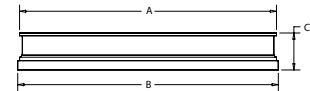

SIDE

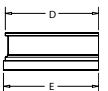

- TRANSITIONAL STYLE
- OPTIONAL BASE SHOWN WITH KENWOOD WALL CABINET IN CUSTOM PAINT AND WHEATFIELD GRANITE

Kenwood Wall Optional Base	A TOP WIDTH	B BOTTOM WIDTH	C HEIGHT	D TOP DEPTH	E BOTTOM DEPTH
43HB	64-1/2"	65-1/2"	10"	28"	28-1/2"
44SB	63-1/2"	64-1/2"	10"	25-1/4"	25-3/4"
48SB	69-1/2"	70-1/2"	10"	25-1/4"	25-3/4"
48DB	69-1/2"	70-1/2"	10"	30"	30-1/2"

# Stain Options

All flush wood mantels and surrounds by Fireside Furnishings are available in paint-grade primed MDF or unfinished maple. Select models are available in unfinished distressed knotty alder. Unfinished mantels are delivered ready to be finished with your choice of paint or stain, or can be stained before shipping. Your mantel provider can supply you with details on price and lead times of the available stain options.

	<i>Natural</i>	<i>Ginger</i>	<i>Ebony</i>	<i>Chocolate</i>
<i>Maple</i>				
<i>Distressed Knotty Alder</i>				



[www.fireplaces.com](http://www.fireplaces.com)

FOR COMPLETE INFORMATION AND VALUABLE ASSISTANCE  
ON THESE MANTELS & SURROUNDS, CONTACT US AT:

The information provided in this literature is for planning purposes only and subject to change. Please consult the installation manual for actual installation.  
Actual product appearance may differ from product images. ©Hearth & Home Technologies® 2016