

This Owner's Manual is provided and hosted by [Appliance Factory Parts](http://www.appliancefactoryparts.com).



Americana 9320U8.181 Owner's Manual

[Shop genuine replacement parts for Americana
9320U8.181](#)



[Find Your Americana Grill Parts - Select From 27 Models](#)

----- Manual continues below -----



9300 SERIES Table Top and Cart Electric Barbecue Grills



9300



9309



9320



9325



9329

Please record your grill's 10 digit serial number here: _____
The serial number is located on the black and silver label on the back side of the element control housing.
Please also save your proof of purchase for warranty purposes.

Electric Grill User's Manual

For Outdoor Household Use Only. Not for Commercial Use.

Need Help? Need to Register Your Grill? Looking for Parts & Accessories?

Visit us online at www.mecocorp.com Or call Customer Service at 1-800-251-7558



! WARNING

- This instruction manual contains important information necessary for the proper assembly and safe use of this appliance. Failure to follow these instructions could result in death or serious injury from explosion or fire.
- Read and follow all warnings and instructions carefully before assembling or using this appliance.
- Keep this manual for future reference. **SAVE THESE INSTRUCTIONS.**

IMPORTANT SAFEGUARDS

W A R N I N G

Read all instructions and warning labels prior to use. Failure to follow these safeguards may result in serious personal injury or property loss. This appliance is intended for outdoor household, non-commercial use only.

- Never touch hot surfaces. Use cooking tongs, gloves, or cooking mitts since the grill will become very hot. USE HANDLES OR KNOBS. Open hood carefully when cooking to avoid burns from the hot air and steam trapped inside.
- Close supervision is necessary when any appliance is used by or near children.
- Do not use appliance for other than intended use.
- Wear clothing that does not have hanging shirt tails, frills, or apron strings.
- Use long-handle barbecue utensils to avoid personal injury caused by burns and splatters.
- To protect against electric shock, never immerse cord, plugs, or electric heating element in water or any other liquid. Do not clean this product with water spray or the like.
- Never leave heating element on when you are not cooking. Unplug grill from outlet when not in use or before cleaning. Allow grill to cool before cleaning or adding and removing parts.
- Never operate any appliance with damaged electrical components or after the appliance has malfunctioned. Inspect regularly supply cord and connections. If Cord, Element or Control is damaged or worn, it must be replaced with an OEM Meco part. Contact Meco Customer Service Department with your grills Serial Number and your Proof of Purchase.
- The use of accessory attachments, not recommended by Meco, may cause injuries.
- Never move a hot grill or leave grill unattended during operation. Unplug grill, close hood, and let cool before moving.
- Never use an electric grill in the rain, sleet, or snow.
- Never use electric grill near combustible or flammable materials; or place on or near a hot gas or electric burner, or in a heated oven. Never let cord touch hot surfaces.
- Electrical cords should be secured while using appliance to protect against personal injury or product damage.
- Always have an ABC fire extinguisher, baking soda or a bucket of sand available in case of an uncontrolled fire.
- Use only a properly grounded 110-120 VAC outlet. Always attach plug to appliance first unless permanently attached. Then plug cord into the wall outlet. Turn Control knob(s) to OFF POSITION before unplugging electric grill.
- Electrical supply cords should always be secured during appliance operation to protect against product damage or personal injury. Never let cord hang over edge of table or counter or touch hot surfaces.
- The use of longer detachable power supply cords or extension cords is not recommended. However, if such cords are used, they must be the same 3-wire grounded type and the electrical rating at least as great as the appliance cord. Outdoor extension cords should be used with outdoor use products and are surface marked with suffix letters "WA" and with a tag stating "Suitable for Use With Outdoor Appliances". Extension cord connections must be kept dry and off the ground and arranged so it will not drape over a countertop or tabletop where it can be pulled or tripped over. The length of the cord should be kept as short as possible.
- Store grill out of the reach of children. Use weatherproof cover for outdoor storage.
- Never allow other persons to be near the grill while in use. Keep bystanders out of the grilling area.

W A R N I N G

- **WARNING!** Fuel, such as charcoal briquettes, is not to be used in this appliance.
- Never use a barbecue grill in your trailer, tent, house, garage, or any enclosed area. Carbon monoxide may accumulate and cause death. Always use your grill in a well ventilated area.



WARNING: Cancer and Reproductive Harm

www.P65Warnings.ca.gov

- Contact Meco if you do not understand any of the instructions in this manual.
- Do not lend your grill without the Owner's Manual. Be sure that anyone using your grill reads and understands the information contained in this manual.

SAVE THESE INSTRUCTIONS

Meco Corporation strives to be a quality supplier of consumer products. If we omitted any parts needed for assembly, or you need troubleshooting information, please contact us using our toll free number or visit our website. It is important to register your grill and retain your receipt.

1-800-251-7558
8 am - 4 pm E.S.T. Monday - Friday
1-423-639-1171 (Telephone)
1-423-639-2570 (Fax)

www.mecocorp.com

Consumer Service Department
MECO CORPORATION
1500 Industrial Road
Greenville, TN 37745 USA

Features That Make Your Meco Grill Outstanding

A Safe, Simple, Clean and Versatile Alternative Grill for Outdoor Cooking

The Americana 9300 Series grills are Safe and Simple to use. There are no ashes to dispose of, no LP tanks to lug to be filled, no bags of charcoal to keep dry or LP tanks to store. It not only gives you steaks seared to perfection, but also cooks chicken to tender, succulent doneness without burning. Go from grilling to rotisserie cooking with the twist of a wrist!

No Fuss – No Mess

You will be ready to cook in less than ten minutes without having to handle fuels, lighter fluids, or fuel cylinders.

Stores Easily

Dramatic new shape is just the right size for today's families. It fits anywhere from the smallest balcony to the largest patio; yet, you can still cook enough filet mignon to serve 16 people.

Easy to Clean

Porcelain coated cooking grid and energy efficient reflector fit most dishwashers.

Real Outdoor Taste

It is the instantaneous searing and burning of the dripping fats that gives food that characteristic outdoor taste. The heat reflector is positioned to drain away enough drippings to prevent flare-ups but leave enough drippings to burst into magic small flames that just kiss the meat and sear it to perfection.

Large Cooking Space

Large cuts of meat, such as roasts, thick chops, whole chickens, and thick burgers with all the trimmings can be prepared faster by cooking with the grill hood closed. The optional rotisserie allows even larger cuts of meat to be cooked and will accommodate cuts up to nine inches in diameter (approximately a twelve pound turkey). With Americana's vertical element, you can cook on the rotisserie without worrying about flare-ups.

Cook Rare and Well Done at the Same Time

The heating element on your new Americana grill adjusts easily to the DUAL LEVEL position so you can cook your companion's steak well-done while you keep yours rare. Also, you can warm bread and grill steaks or cook shrimp and steak simultaneously. Now you can do all of that at the same time with just one easy turn of the control handle.

Saves Energy, Saves Money

You can cook for an hour at the high temperature setting (SETTING 3) for just pennies, even in the highest electrical cost areas of the country.

Pre-assembled

All critical electrical and mechanical components, including the hinges and handles are pre-assembled at the factory for your convenience. The sturdy construction of Americana Electric Grills comes from the high quality steel forms and tubing used throughout. All components are coated with our quality Dura Fuse powder finish for beauty and durability.

Instant Heat Control

Your cooking temperature can be adjusted instantly from a steak searing high to a bread warming low with the variable heat control. Bright graphics on the control knob shows at a glance whether the grill is on or off, and a highly visible pilot light shows when the element is energized.

Optional Rotisserie Kit

The high volume hood shape also allows you to cook chickens, roasts, hams, and turkeys with the optional rotisserie kit.

If you purchased a grill that did not include a Rotisserie Kit, contact Customer Service at: 1-800-251-7558 or go to www.mecocorp.com.

BREAK-IN:

Place your grill in a well ventilated area. Make sure overhead combustible surfaces are at least four feet above grill. If you have a table model grill, put it on a sturdy surface, away from the edge, and out of the reach of children. Keep the electrical cord out of walkways so it will not be tripped over.

Plug the power cord into a 110-120V~ outlet of at least 15A capacity.

MAKE SURE NO OTHER HIGH WATTAGE APPLIANCES ARE PLUGGED INTO THE SAME CIRCUIT.

Shut the hood of the grill. Turn the Handle Control so the element is in the horizontal position and set the Control Knob to SETTING 3. Allow the grill to operate for at least fifteen minutes to burn away any lubricants that may have been left on during the manufacturing process. As soon as the “new” smell goes away, you will be ready to cook!

TEMPERATURE CONTROL:

There are three ways to control the cooking temperature of your Americana Electric Grill with Rotisserie Cooking:

(1) The CONTROL KNOB is for turning the grill on and off and to vary the cooking temperature from a “searing steak” (SETTING 3) down to a “keep warm” (SETTING 1)



(2) The DUAL LEVEL element position allows you to get lower temperatures at the front of the cooking grid and higher temperatures at the back. This means you can cook foods that require different temperatures at the same time.

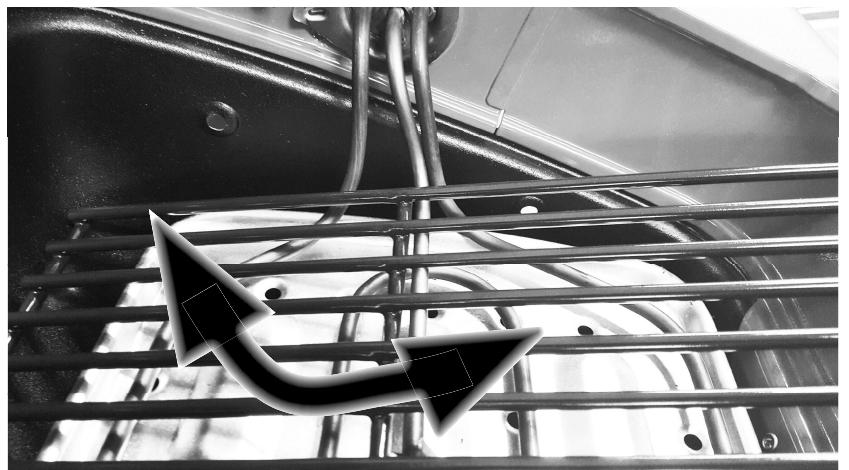

(3) The HINGED HOOD can be closed or left open to vary the cooking temperature. With the hood closed, you will get higher temperatures and more smoky flavor when using hickory or mesquite chips. With the hood open, the heat and smoke are allowed to escape.

THERE ARE THREE WAYS TO COOK ON YOUR ELECTRIC GRILL:

(1) The Direct method is for steaks, chops, chicken pieces, and other foods that require SETTING 3 (High) heat and short cooking time. Just put the meat directly on the grid for cooking this way.

(2) The Indirect method is for cooking large roasts and poultry that requires SETTING 1 (Low) heat and long cooking times. When using this method, make a drip pan from aluminum foil to fit between the element and the piece of meat. You can put the pan directly on the grid or between the element and the grid. The pan reflects part of the heat away from the meat to prevent it from burning on the bottom and it catches the juices which you can use for gravy when you serve the meat.

Note: Disposable aluminum drip pans are available at your local grocery store. If you do not have access to an aluminum drip pan, a homemade drip pan can be made. The drip pan can be made by cutting a piece of aluminum foil about twenty-four inches long, folding it in half and then folding each end and side up about one inch. Pinch the ends so they will not leak. Always use a meat thermometer for checking the doneness of meats cooked this way. Be sure to take the meat off a little before the thermometer indicates the doneness you want because the meat will continue to cook while it sets. Let stand about twenty minutes before carving.

(3) Rotisserie. Your Americana Electric Grill is designed to accommodate even larger pieces of meat and poultry when using the optional Rotisserie. This method allows you to cook turkeys as large as twelve pounds or other pieces of meat as large as 9 inches in diameter, with very little of your attention.

*NOTE: Use an aluminum drip pan when cooking turkeys or roasts. With the meat constantly rotating, it will cook more evenly. Also, the vertical element design eliminates the possibility of flare-ups. To obtain a Rotisserie Kit, see your dealer or visit www.mecocorp.com.

Refer to the handy Quick Glance Cooking Guide page for information about recommended cooking times and temperatures for various types of foods.

The juices and fats that drip down from the meat and fall onto the hot element and reflector vaporize to create the smoke and small amount of flame that gives your meat that "outdoor barbecue" flavor. Sometimes, meat with a lot of fat may cause excess flare-up. When this occurs, turn the control knob to SETTING 1 and shut the hood. The flames will extinguish quickly. **DO NOT USE WATER TO PUT OUT THE FLAMES.**

PREPARATION FOR COOKING:

For easy clean-up, spray the cooking grid with a non-stick vegetable spray before you turn on the grill. Do not spray the reflector. Make sure the GREASE CUP or pan is in its holder underneath the grease drain hole at the back of the grill.

NOTE: Use an aluminum drip pan when cooking turkeys or roasts.

Preheat the grill for at least five minutes when cooking steaks and hamburgers, longer when the outside temperature is below 68° F. Other foods can be cooked without preheating the grill, but you should add at least five minutes to the total cooking time.

Marinades can be used to enhance the flavor of meat and to tenderize the cheaper cuts of meat. Look for them in your favorite barbecue cookbooks or grocery store.

Barbecue Sauces applied during the last ten to fifteen minutes give that old time outdoor barbecue flavor to grilled chops, burgers, chicken, and ribs. Most barbecue sauces have a tomato and/or sugar base which burns easily, so be sure to brush on the sauce only during the last few minutes of cooking.

Combination Butters also lend a nice delicate touch to chicken, fish, and steaks. For chicken and fish, try brushing on a combination of butter and grated lemon peel or parsley. For steaks, mound on a dollop of garlic butter just before serving. Use your imagination to come up with other delicious combination butters for your own personal touch.

Smoke flavor can easily be added to any of the foods you cook on your Americana Electric Grill. You can get chips of hickory, mesquite, apple, cherry, and other aromatic woods at most supermarkets. Soak the chips in water for at least thirty minutes or overnight before cooking, shake the excess water, and scatter them around the reflector. Cook with the hood closed for the most smoke flavor.

Care and Maintenance - End of Cooking Session

! WARNING

To reduce risk of serious injury or death from fire or burn hazard:

- Allow grill and grease in the Drip Cup to completely cool before emptying, cleaning, moving, or storing grill.
- Empty the Drip Cup after each cooking session so grease does not accumulate.

To keep your grill operating at its peak performance, move the Handle Control to the element vertical/Rotisserie position after each use. Turn the Control Knob to SETTING 3 for about ten minutes to allow excess drippings to drain into the bottom of the Bowl.

As you use the grill, some of the drippings may accumulate as hard deposits and the reflector pan will become stained. A small putty knife or wire brush works very well for scraping out the deposits. Please note that it does not always have to be shiny clean nor is it necessary to clean the Reflector Pan after each use. When you do have to remove and clean reflector, remove Cooking Grid and follow these steps:

Step 1. Rotate Handle Control counterclockwise to Remove Reflector position and Lock the Rotisserie Lock.

Step 2. Using both hands, pinch bottom Element Coil and Reflector Pan with thumbs and first two fingers.

Step 3. Push Reflector Pan up off the support brackets.

Step 4. Slide Reflector Pan up from rear of Bowl.

Clean the Reflector Pan with water and dish detergent or in a dishwasher. Clean the inside of the grill with a soft cloth and hot soapy water or a good strong cleaner.

DO NOT USE OVEN CLEANER OR ABRASIVE SCOURING POWDERS. THIS MAY REMOVE THE PAINT.

Rinse out any excess detergent and then dry the inside of the grill with a soft cloth.

Empty the Drip Cup and replace it for the next time you cook. Wipe off the outside surfaces of the grill with a soft cloth and a mild detergent and water solution. Rinse and wipe dry. Replace the Reflector Pan while the Handle Control is still in the extreme vertical clockwise position.

Step 5. Slide Reflector Pan down, between element and back of bowl. Push it down over Support Brackets, squeezing against Reflector Pan and top Element Coil.

Return the Handle Control to the horizontal element position, replace Cooking Grid and you are ready to cook again.

Keep the permanent beauty of your Americana Electric Grill by always storing it in a dry, sheltered place. Use a cover if you store the grill outside. To obtain a grill cover, see your dealer or visit www.mecocorp.com.

Step 1



Step 2



Step 3

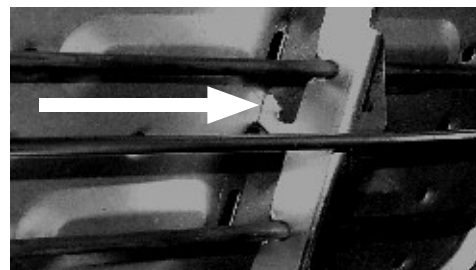

Step 4

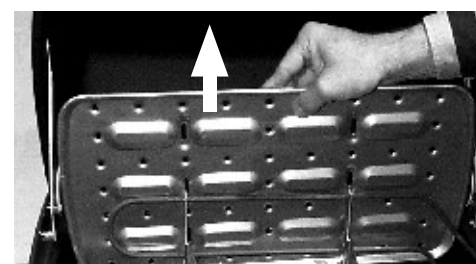

Step 5



Meco 9300 Series Electric Grill Models



9300

9300
Basic Table Top Model



9309

9309
Basic Table Top Model
PLUS
- Window
- Rotisserie Kit
(Spit, Forks, Bracket & Motor)



9320

9320
Basic Cart Model



9325

9325
Basic **CART** Model
PLUS
- Two Folding Side Tables













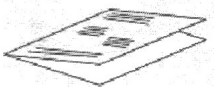
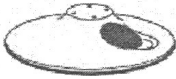



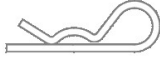

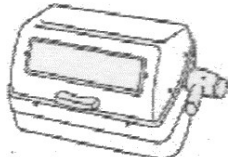



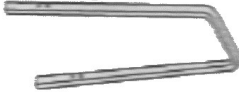





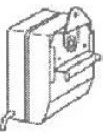

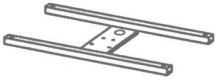

9329

9329
Basic **CART** Model
PLUS
- Two Folding Side Tables
- Leg Shelf
- Window
- Rotisserie Kit
(Spit, Forks, Bracket & Motor)

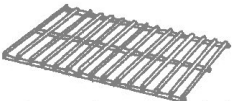
Meco 9300 Series Parts List and Illustrations

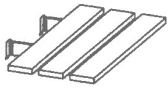
Item	Part / Desc.	Part #	QTY	Model
1	Owner's Manual	03.5875.02	1	All 9300 series
2	Hood / Bowl Assembly	—	1	9300, 9320, 9325
3	Hood / Bowl Assembly	—	1	9309, 9329
4	Bolt #10-24 x 1/2"	03.0201.02	5	All 9300 series
5	Rotisserie Lock	17.1698.00	1	All 9300 series
6	Acorn Nut #10-24	03.5000.55	1	All 9300 series
7	Lock Nut #10-24	03.0390.00	20	All 9300 series
8	Cooking Grid	03.0710.00	1	All 9300 series
9	Reflector Pan	17.5421.00	1	All 9300 series
10	Base, Table Top	17.5438.18	1	9300, 9309
11	Foil Drip Cup	03.5145.00	1	All 9300 series
12	Roller Leg	17.1681.18	1	9320, 9325, 9329
13	Fixed Leg	17.1682.18	1	9320, 9325, 9329
14	Bolt #10-24 x 1 1/4"	03.5007.00	12	9320, 9325, 9329
15	Leg Cap	03.0735.00	2	9320, 9325, 9329
16	Top Frame	18.1637.18	1	9320, 9325, 9329
17	Bolt, #10-24 x 2"	03.5007.01	4	9320, 9325, 9329
18	Rivet Axle	03.0104.06	2	9320, 9325, 9329
19	Wheel	03.5001.04	2	9320, 9325, 9329
20	Cotter Pin	03.4146.00	2	9320, 9325, 9329
21	Wire Hanger, Drip Cup	03.6324.01	1	9320, 9325, 9329
22	Flexible Base Extrusion	02.0336.00	1	9300, 9309
23	Insert Plug	03.0734.01	4	9320 model
24	Crossbrace	17.1679.18	2	9320, 9325
25	Wire Leg Shelf	17.1699.18	1	9320, 9325
26	Side Table	18.5724.00	2	9325, 9329
27	WPC Leg Shelf	18.1636.00	1	9329
28	Window Glass	03.5107.00	1	9309, 9329
29	Bolt Carriage #10-24x1/2"	03.5108.01	2	9309, 9329
30	Window Retainer Clip	17.5443.00	2	9309, 9329
31	Wing Nut #10-24	03.5750.00	2	9309, 9329
32	Rotisserie Motor	03.5002.00	1	9309, 9329
33	Split Shaft	17.1529.00	1	9309, 9329
34	Split Fork	03.5750.00	2	9309, 9329
35	Bracket, Motor Mounting	17.5419.11	1	9309, 9329

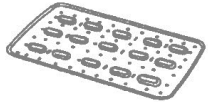
Meco 9300 Series Parts List and Illustrations

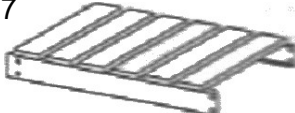
- | | | | | | | | |
|---|---|----|---|----|--|----|---|
| 1 |  | 10 |  | 19 |  | 28 |  |
| 2 |  | 11 |  | 20 |  | 29 |  |
| 3 |  | 12 |  | 21 |  | 30 |  |
| 4 |  | 13 |  | 22 |  | 31 |  |
| 5 |  | 14 |  | 23 |  | 32 |  |
| 6 |  | 15 |  | 24 |  | 33 |  |
| 7 |  | 16 |  | 25 |  | 34 |  |
| 8 |  | 17 |  | 26 |  | 35 |  |
| 9 |  | 18 |  | 27 |  | | |

Preparation for Assembly

READ ALL INSTRUCTIONS in the Owner's Manual before you start.

VERIFY PARTS. Remove all parts from the box and arrange on a smooth clean surface. Verify that you have all the parts listed in the below "Parts List".

If you have any questions or need help, contact Customer Service at 1-800-251-7558 or go to www.mecocorp.com. Be sure to have the grill model number listed on the front cover of this Manual. If you need replacement parts, look in the Parts List to find the exact parts you need. If you need a replacement part under warranty, a proof of purchase will be necessary. You will be asked to forward your proof of purchase via e-mail, or to fax your proof of purchase to 423-639-2570 and reference your model number. It is important to register your grill and retain your receipt.

Tools Required for Assembly:



Phillips and/or
Straight Screwdriver



Pliers

or

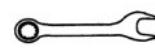

3/8" Wrench

or



Adjustable Wrench

Assembly Instructions

ROTISSERIE LOCK TO HOOD/BOWL ASSEMBLY (All Grills)

Insert a 10-24 x 1/2 inch Bolt (4) through the hole between the hood hinges and the electric heating element. Attach Rotisserie Lock (5) to the Bowl (FIG A). Thread Acorn Nut (6) onto Bolt until the flat side of the lock contacts the inside surface of the Grill. You may need pliers to hold the Acorn Nut. The Rotisserie Lock must remain in contact with the inside surface of the Grill as it is rotated upward, but should fall freely when released.

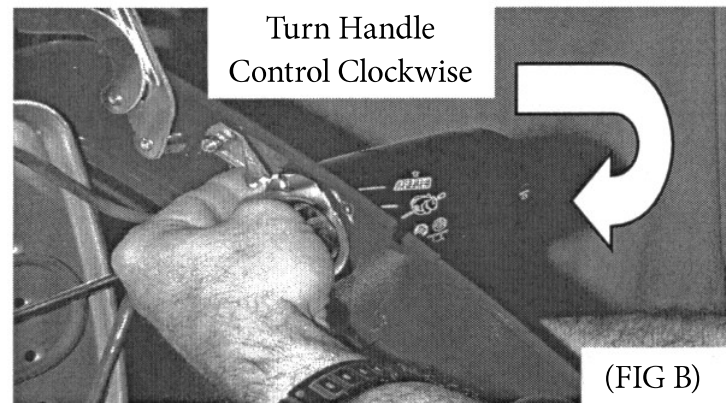
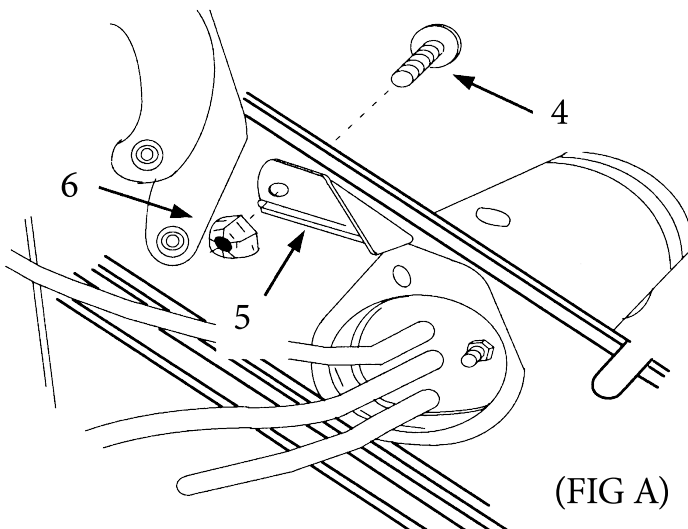

To release Reflector Pan and Heating Element from the vertical Rotisserie position, rotate the Handle Control clockwise slightly to release the pressure from the Rotisserie Lock. Lift Rotisserie Lock up with left forefinger and rotate Handle Control back to horizontal element position. (FIG B)

SHELF & LEG ASSEMBLY (9320 - 9325)

WIRE LEG SHELF: (FIG C) Make certain "INDENTS" are to the outside on both Roller (12) and Fixed Legs (13). Attach a Crossbrace (24) to each side of the Legs with #10-24 x 1 1/4" Bolts (14) and #10-24 Lock Nuts (7). Make sure the Star Washer on the Lock Nut is against the Crossbrace. Use eight Bolts and Nuts for assembly; tighten only snug. Fit the ends of the Wire Leg Shelf (25) into the holes on top of each Crossbrace.

(9329)

WPC LEG SHELF (27): (FIG D) Same as Wire Leg Shelf except the except Crossbraces are already attached to the shelf slats. Attach the crossbraces to the Legs with #10-24 x 1 1/4" Bolts and #10-24 Lock Nuts, tighten only snug.

Push two Leg Caps onto the bottom of the Fixed Leg.

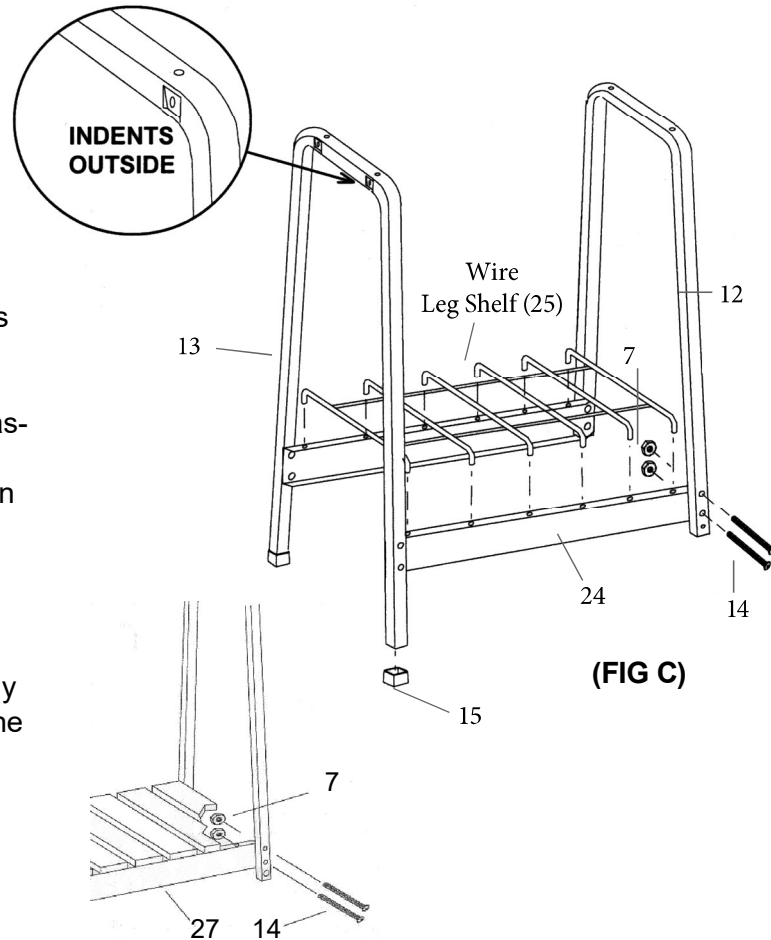

(FIG D)

TOP FRAME ASSEMBLY (9320 - 9325 - 9329)

(FIG E) With the Roller Leg to the Left, attach the Top Frame (16) to the Legs. Place the Top Frame ends underneath the top of the Fixed and Roller Leg Frames.

NOTE: Make sure the large hole in the Top Frame is to the rear and the Top Frame's edges are down. Insert a #10-24 x 2" Bolt (17) through the Leg Frames and ends of the Top Frame. Attach 10-24 Lock Nuts and tighten snug.

(FIG F) If your Grill did not come with accessory Side Tables (9320 Model), close up the four square ends of the Top Frame with Insert Plugs (23).

At this time go back and tighten all Bolts and Nuts securely before proceeding.

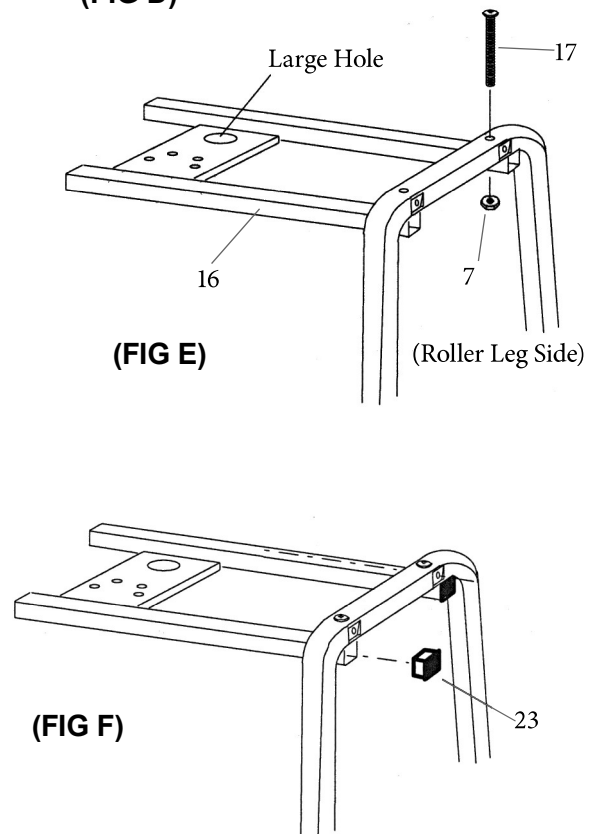

(FIG F)

WHEEL ASSEMBLY (9320 - 9325 - 9329)

(FIG G) Insert an Rivet Axle (18) through the center hole on the recessed side of the Wheel. (The opposite side that is placed against the Leg Tube has a raised cone shaped center.)

Insert the end of the Axle, that extends through the Wheel, through the hole in the end of the Roller Leg Tube (12) and fasten in place by inserting the Cotter Pin (20) through the hole in the end of the Axle. (FIG H)

NOTE: Wheel assembly will not fit tightly, but will be secure.

Set assembled Frame up on the Wheels and Legs (FIG I).

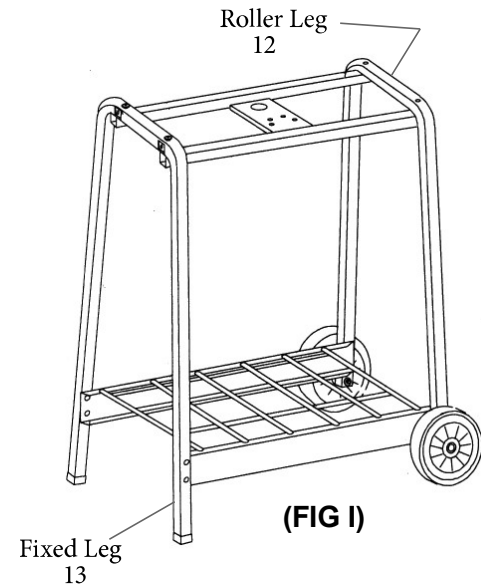
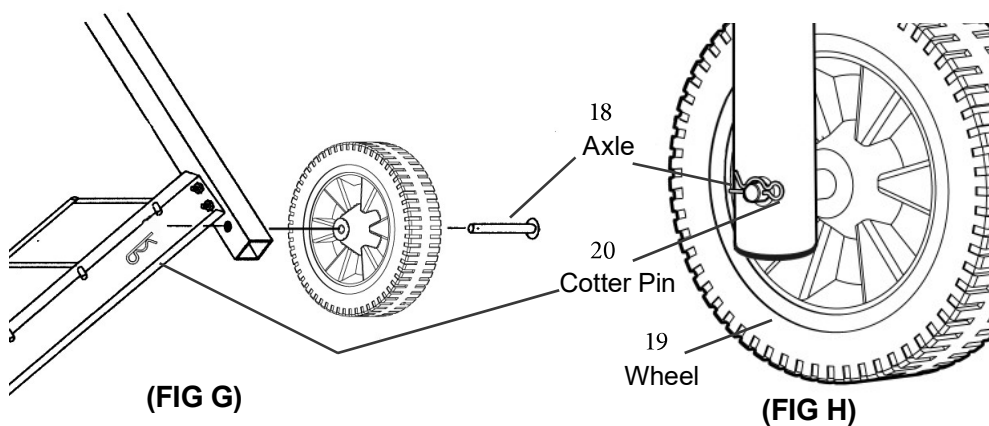

SIDE TABLE ASSEMBLY (9325 - 9329)

(FIG J) Attach a Side Table (26) to either end of the Cart by inserting 10-24 x 1 1/4" Bolt (14) through the top hole in the Pivot Bracket of the Side Table and then through the hole of the Fixed or Roller Leg. Attach and tighten with 10-24 Lock Nuts (7). You can leave the Side Tables up or fold them down for storage. To fold them down, slide the Arm Brackets up within the Pivot Bracket and rotate the Table downward. (FIG K)

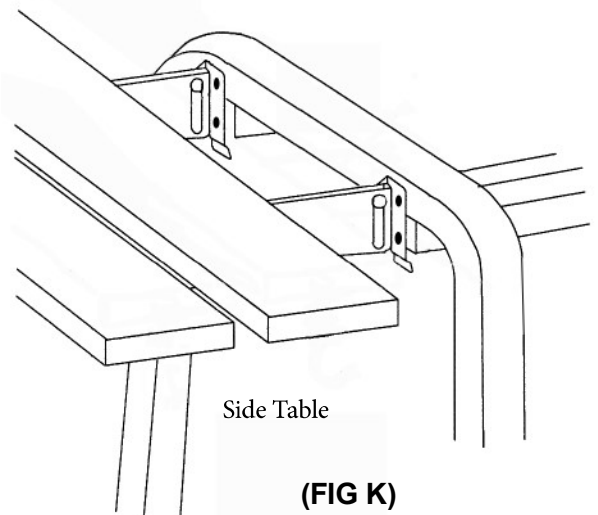
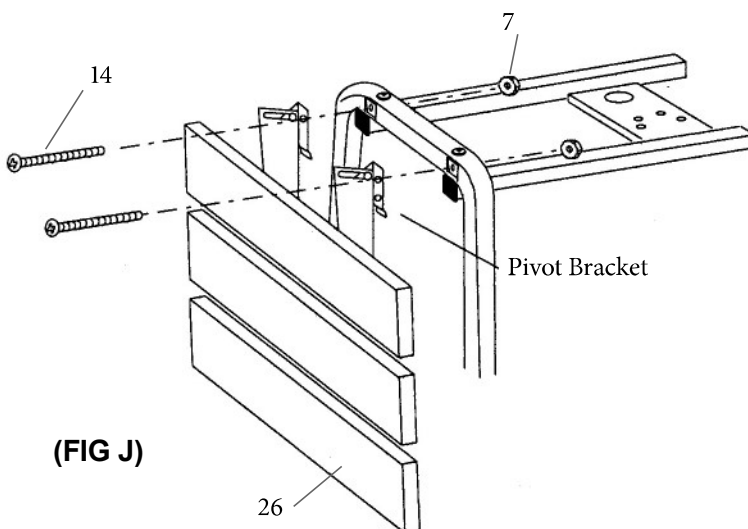

HOOD/BOWL ASSEMBLY TO CART (9320 - 9325 - 9329)

Rotate the element, using the Control, to the Vertical/Rotisserie position. Set Hood/Bowl assembly over the holes in the Top Frame. (FIG L) 10-24 x 1/2" Bolts through the Grill Bowl and through the Top Frame. Attach four 10-24 Lock Nuts and tighten securely.

(FIG L)

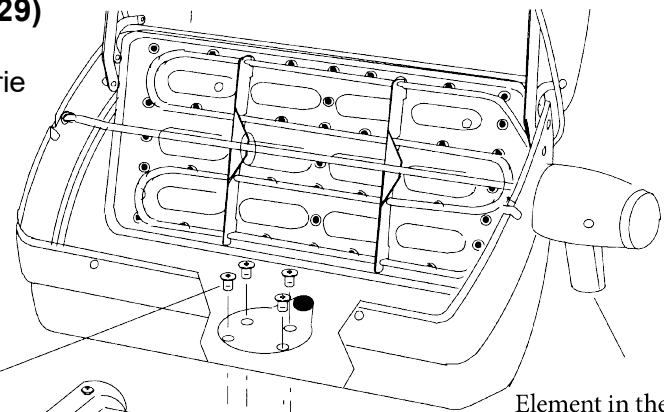

DRIP CUP ASSEMBLY (9320 - 9325 - 9329)

Install the Wire Drip Cup Holder (21) by holding the small loop at the top of the wire then threading the other end down through the indicated hole in the center of the bottom of the grill bowl until the wire is hanging by the small loop. Snap the foil Drip Cup (11) into the opening in the wire under the grill. (FIG M)

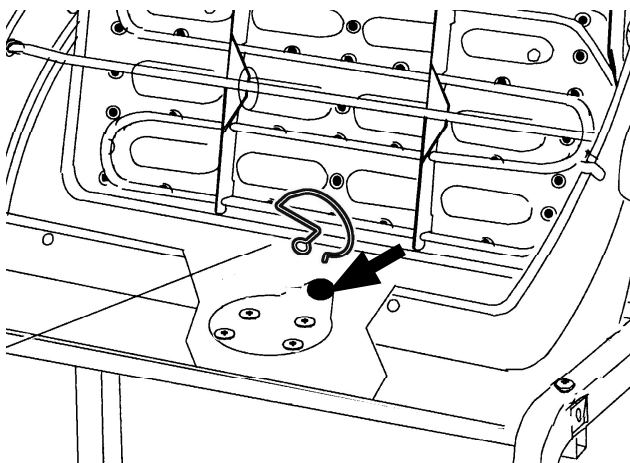
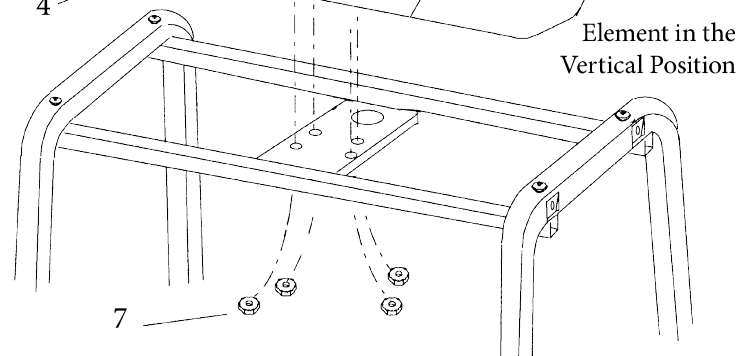

(FIG M)

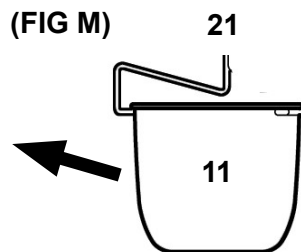

BASE ASSEMBLY: (9300 - 9309)

Place Main Grill Assembly (2 or 3) on its back. Turn the Control Housing to the Rotisserie position.

Set Main Grill Assembly over the holes in the Table Top Base (10). (FIG N) Make sure the hole patterns are aligned between each part and the large round depression in the Base is toward the rear. Insert four 10-24 x 1/2" Bolts (4) through the Grill Bowl and the Base. Attach four 10-24 Lock Nuts (7) and tighten securely.

Starting at the back, align the gap in the Flexible Base Extrusion (22) with the lip on the bottom of the Table Top Base and press firmly in place around the entire perimeter.

Set the Grill Assembly up on the Base. Place the Drip Cup (11) into the large depression in the back of the Base.

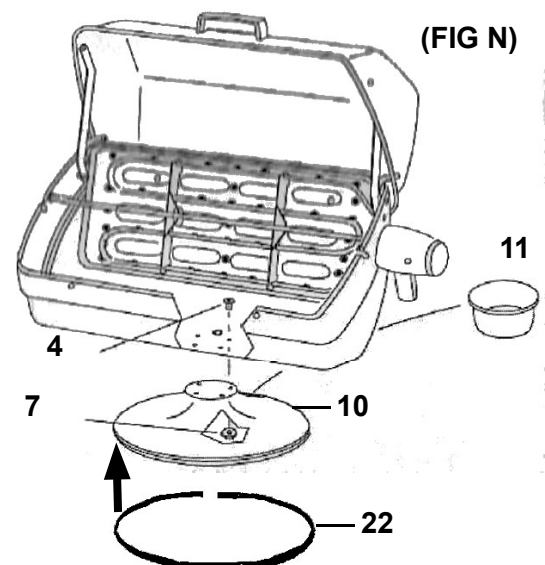

WINDOW ASSEMBLY (9309 - 9329)

Open Hood and lay Window Glass (28) into window recess. (FIG O)

Insert Carriage Bolt (29) from outside of Hood through hole and install Window Retainer Clip (30) on Bolt. The Long Flange of the Retainer Clip should be against the Window. Put Wing Nut (31) on Bolt, Tighten with fingers until snug.

NOTE: DO NOT OVER TIGHTEN

Repeat for the other side. Window assembly should look like (FIG P) when complete.

CAUTION: This is a heat resistant tempered glass. Take care not to drop water on hot glass.

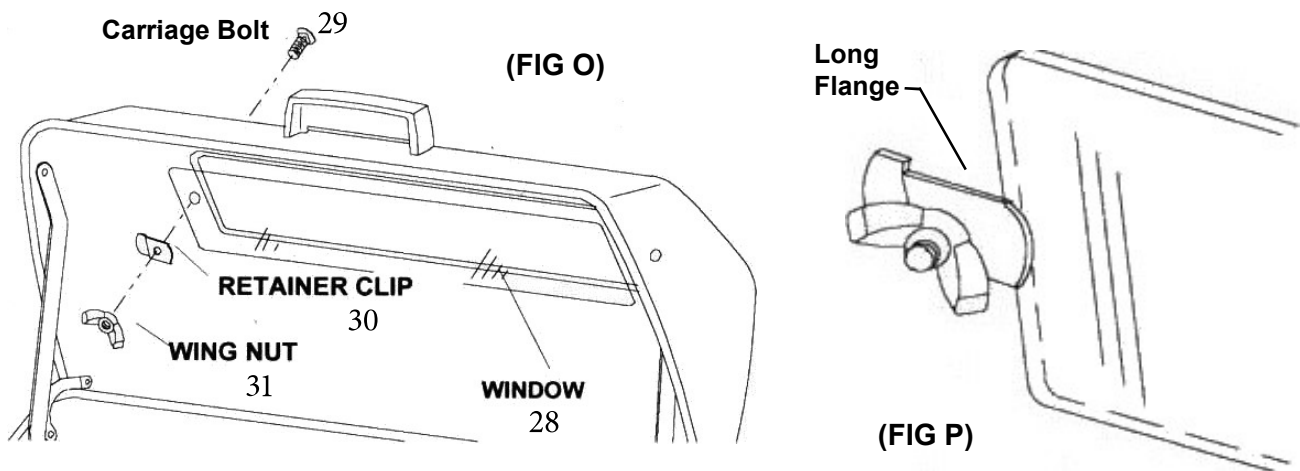

FINAL ASSEMBLY (ALL GRILLS)

Lift Rotisserie Lock and move Control Housing to horizontal element position. Set the Cooking Grid (8) on the two Rear Bumps in the back of the Grill Bowl and the two support studs in the front of the Bowl. (FIG Q)

(FIG Q)

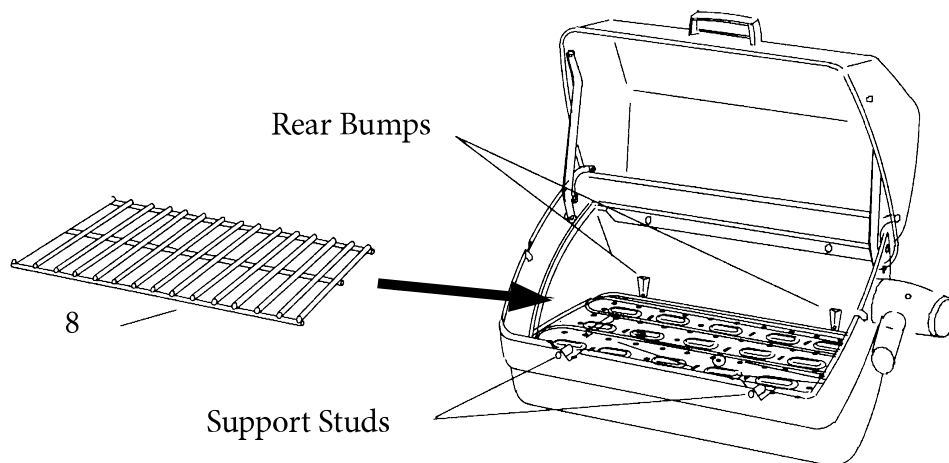

Your grill is now ready for use, but FIRST READ SAFETY PRECAUTIONS AND ALL OPERATING INSTRUCTIONS IN THIS OWNER'S MANUAL BEFORE USING YOUR GRILL.

QUICK GLANCE COOK GUIDE				
TYPE OF FOOD	Cooking Temperature	COOKING TIME	COOKING METHOD**	Temperature When Done*
BEEF: Steaks, Kabobs	POSITION 3	1" thick, rare 3-4 min/side med 5-6 min/side well 6-7 min/side	1	N/A
HAMBURGERS	POSITION 3	3/4" thick, rare 4-5 min/side med 5-6 min/side well 6-8 min/side	1	N/A
ROASTS	POSITION 2	Rump Rolled, 4-6 lb. rare 20 min/lb. Rib 6-8 lb. rare 16-18 min/lb. med 18-20 min/lb.	2	140 ° F 160 ° F 170 ° F
LAMB ROASTS	POSITION 2	Rib, 2-3 lb. rare 25-30 min/lb. med 30-35 min/lb. well 35-40 min/lb. Leg, 4-7 lb. rare 18-22 min/lb. med 22-28 min/lb. well 28-33 min/lb. Shoulder, 4-6 lb. med 22-28 min/lb. well 28-33 min/lb.	2	140 ° F 160 ° F 170 ° F 140 ° F 160 ° F 170 ° F 160 ° F 170 ° F
SEAFOOD FISH	POSITION 2	10 min. per inch of thickness	1	flakes with fork when done
SHRIMP, SCALLOPS	POSITION 2 +	5-10 min. total		
OYSTERS, MUSSELS		5-10 min. total		
LOBSTER		10-20 min. total		
PORK CHOPS	POSITION 2	1" thick, 12-15 min. 2" thick, 20-25 min.		
Spare Ribs	POSITION 2	45-60 min. total	1	170 ° F
Roasts, 5-7 lb.		Loin, 3-5 lb. 25-30 min/lb. Boston Butt, 4-6 lb. 20-26 min/lb. Leg, (fresh ham) 5-8 lb. 18-24 min/lb.		
HAM	POSITION 2	Fully Cooked, 8-10 min/lb. Uncooked, 12-18 min/lb.	2	140 ° F 160 ° F
POULTRY	POSITION 2	Whole, 2 1/2-3 1/2 lb. 35-45 min/lb.	2,3	175 ° F
Chicken		Pieces, Quarters, 50-70 min. total	2	
Cornish Hens	POSITION 2	Whole, 45-60 min. total	2,3	175 ° F
		Butterflied, 30-40 min. total turn frequently	2	
TURKEY	POSITION 2	Whole, 8-12 lb. 15-20 min/lb.	2,3	175 ° F
DUCK		Whole, 4-12 lb. 25-35 min/lb.		
GOOSE		Whole, 8-12 lb. 20-30 min/lb.		
VEGETABLES	POSITION 2		1	
POTATOES		60-75 min. total		
MUSHROOMS		8-12 min. total		
CORN-ON-THE COB		(in moistened husks) 15-20 min.		
ZUCCHINI, ONIONS		20 min. total		
PEPPERS, SQUASH		turn frequently		
EGGPLANT				
* Times are approximate and will vary with outside temperature, wind conditions and number of times you open the hood. NOTE: Large Roasts and Poultry should be allowed to set for about twenty minutes before carving. The internal temperature will rise about 10 degrees, and the meat will firm up for easier carving.				
** 1 - Direct (See p. 4) 2 - Indirect (Use a drip pan under the meat, see p. 4) 3 - Rotisserie - (See p. 4)				

RECIPES YOU CAN USE AGAIN AND AGAIN

Juicy Burgers...

1 beef bouillon cube	1/2 teaspoon salt
1/2 cup boiling water	1/2 teaspoon pepper
1 pound ground beef	1/2 teaspoon ground sage
1/3 cup dry bread crumbs	1/2 teaspoon ginger
1 teaspoon grated lemon peel	4-5 hamburger buns toasted

Dissolve bouillon cube in boiling water. Mix thoroughly with beef, crumbs, lemon peel and seasoning. Shape into four or five patties and chill thoroughly. Grill on High Setting until desired temperature is reached. Serve on toasted buns. Makes 4 or 5 servings.

Barbecued Pork Chops...

1 1/2 cups water	2 teaspoons salt
3/4 cup catsup	1/2 teaspoon pepper
3/4 cup white vinegar	1/4 teaspoon hot sauce
1 medium onion, chopped	8 (1 1/4 inch thick)
1 clove garlic, minced	pork loin chops
3 tablespoons brown sugar	
1 tablespoon Worcestershire sauce	

Combine first 10 ingredients in a medium saucepan, stirring well; bring to a boil. Reduce heat, and simmer, uncovered, 30 minutes, stirring occasionally. Remove sauce from heat; set aside.

Trim excess fat from chops. Grill over medium heat using Direct method until desired temperature has been reached. Baste frequently with sauce. Bring remaining sauce to a boil in a saucepan. Remove from heat. Serve pork chops with remaining sauce. Makes 8 servings.

Lemon & Dill Grilled Salmon

1 large salmon fillet (either with or without skin)
 1/4 cup of lemon juice (approx. 1/2 lemon)
 1/4 - 1/2 cup of mayo
 fresh or dried dill to taste
 coarsely ground black pepper to taste
 1/4 cup of olive oil (only for skin on fillet)

Wash and dry the fillet. If cooking a skin-on fillet, apply olive oil to the skin only to keep the fillet from sticking to the cooking grid. Flipping is not necessary. Apply lemon juice and let sit for 5 minutes. Generously spread mayo on top of the fillet. NOTE: This step is to help keep the meat moist and not for flavor purposes. Season with dill and pepper to taste. Cook until the meat starts to flake and is barely opaque in the center. This takes roughly 10-15 minutes on the High Setting. The salmon will continue to cook after removing from the grill. Do not overcook.

Island Steak...

6 rib-eye steaks (approx. 1 inch)
 1 cup soy sauce
 1 clove garlic (crushed) 1/4 cup salad oil
 1/4 cup dry red wine
 juice from small piece of celery
 (approx. 1/4 medium size stalk)

Combine all ingredients except the steak (use garlic press to get celery juice). Marinate the steaks with this mixture for 30 minutes only. Drain the steaks and sear each side one minute on High Setting. Lower temperature to Medium and cook until desired temperature has been reached. Turn steaks twice. Makes 6 servings.

Marinated Beef Roast on the Rotisserie...

1 (5 to 6 pound) beef tenderloin, trimmed
 3 1/2 cups Magnificent Marinade

Place tenderloin in the large shallow dish or a heavy-duty, zip-top plastic bag. Pour Magnificent Marinade over tenderloin. Cover and marinate in refrigerator 6 to 8 hours, turning occasionally.

Remove tenderloin from marinade. Tie tenderloin securely with heavy string at 2-inch intervals. Thread tenderloin on spit; secure with prongs at each end of spit. Balance tenderloin properly to avoid strain on motor. Place spit on rotisserie. Grill tenderloin, hood closed, on Medium-Hot setting of grill until meat thermometer registers 140 degrees Fahrenheit (rare) or 160 degrees Fahrenheit (medium). Remove tenderloin from spit. Let stand 10 minutes before slicing. Makes 10 to 12 servings.

Magnificent Marinade...

1 1/2 cups vegetable oil	3/4	1 tablespoon coarsely ground pepper
cup soy sauce		2 1/2 teaspoons salt
1/2 cup red wine vinegar	1/3	2 teaspoons chopped fresh parsley
cup lemon juice		
1/4 cup Worcestershire sauce		
2 cloves garlic, crushed		
2 tablespoons dry mustard		

Combine all ingredients in a medium bowl, stirring well. Store in an airtight container in the refrigerator. Makes 3 1/2 cups.