



LOVE AT FIRST LIGHT

Please consult the manufacturer's installation manual for all details and requirements before making a final design layout decision.

Lo-Rider 42

Vent Free Gas Firebox

MODEL	FRONT WIDTH		BACK WIDTH		HEIGHT		DEPTH		VIEWING AREA
	Actual	Framing	Actual	Framing	Actual	Framing	Actual	Framing	
LCUF42	48"	48-1/2"	35-1/2"	48-1/2"	34"	34-1/4"	23"	22-3/4"	42" x 30"

FRONT VIEW

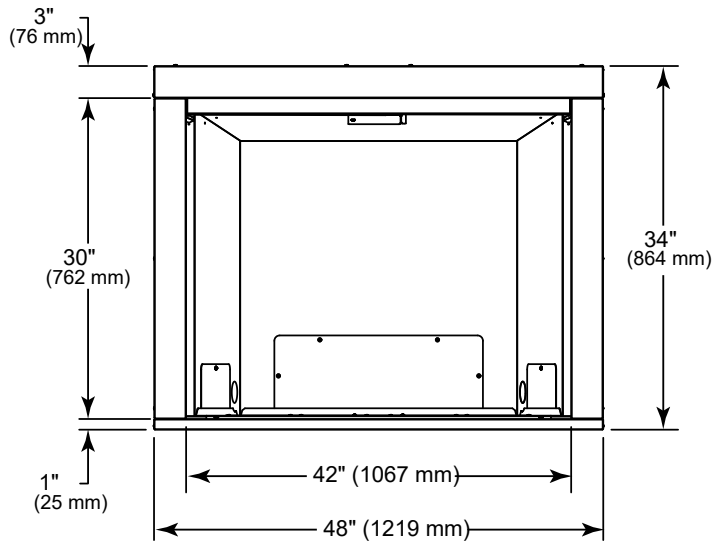

TOP VIEW

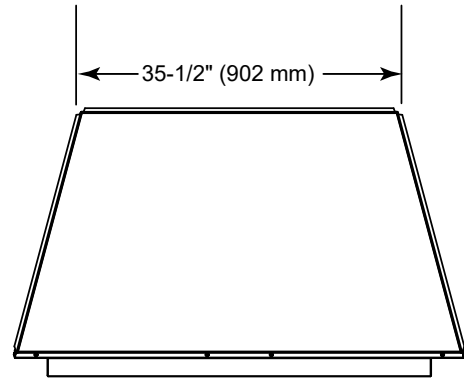

LEFT SIDE VIEW

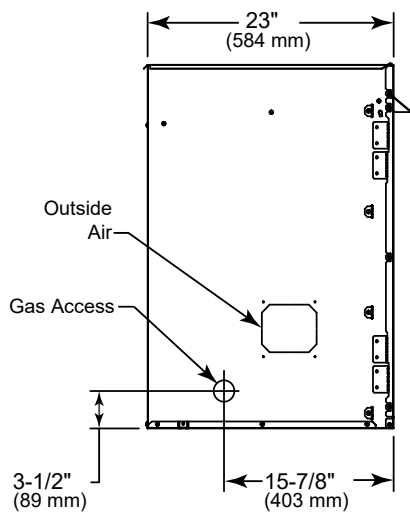

RIGHT SIDE VIEW

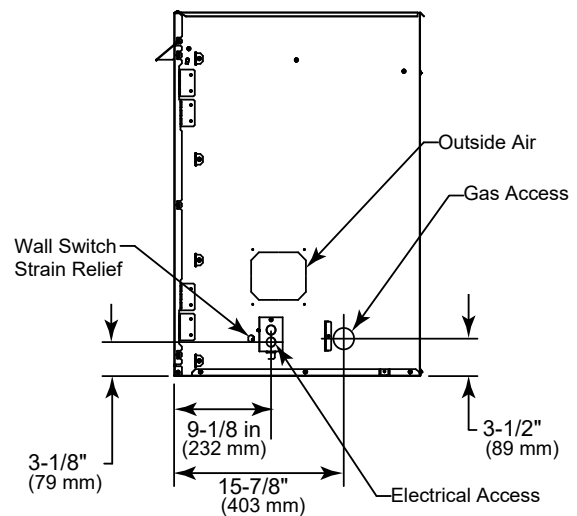

FRAMING DIMENSIONS

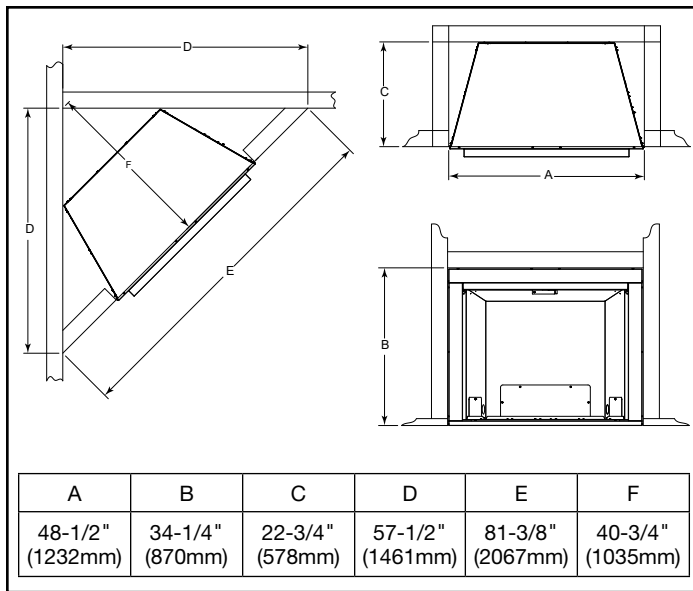

CLEARANCES TO COMBUSTIBLES

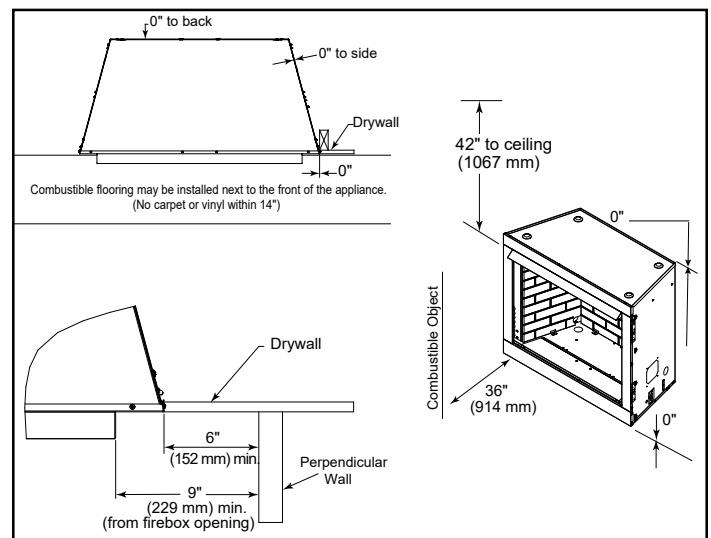

MINIMUM HEARTH DIMENSIONS

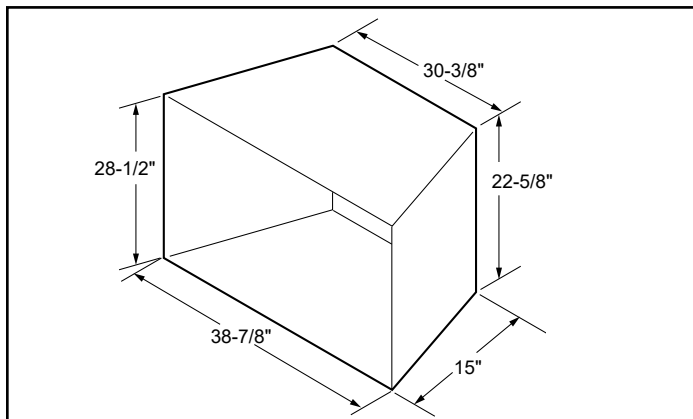

MANTEL CLEARANCES

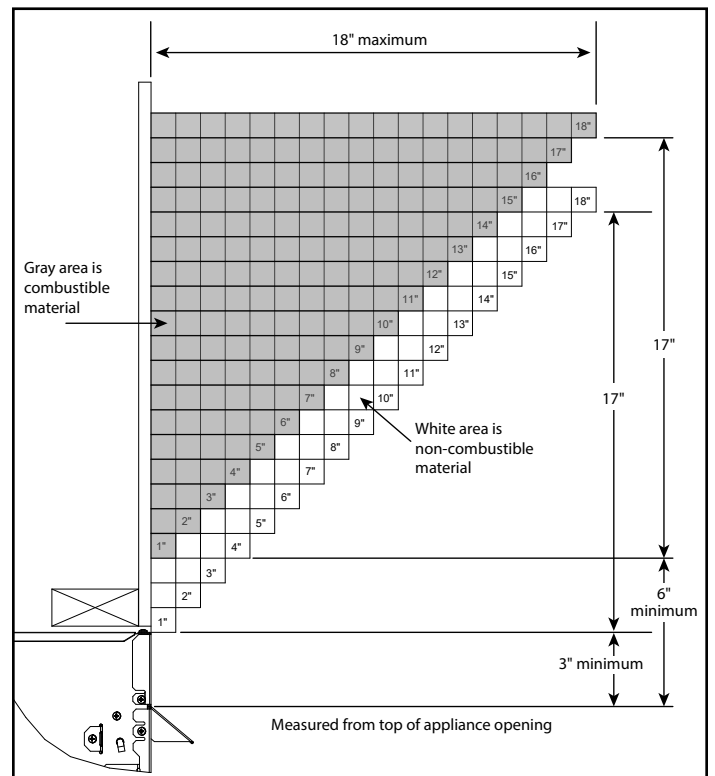

MANTEL LEG CLEARANCES

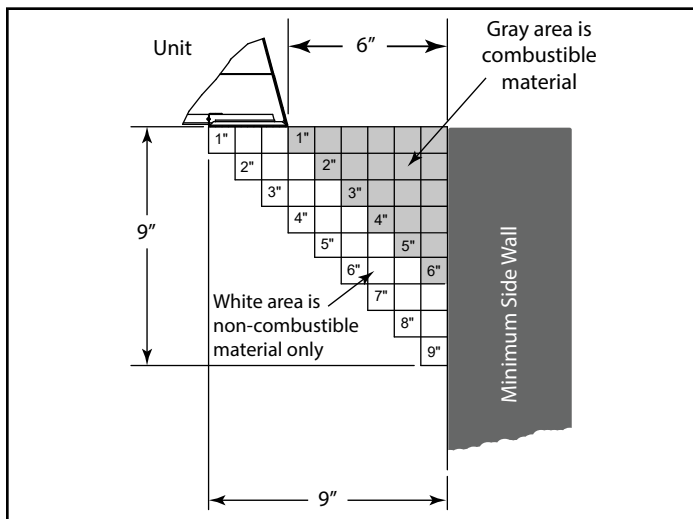

PRODUCT LISTING CODES	
US	ANSI Z223.1 / NFPA54 ANSI Z21.11
	CSA Design Certified

Product information provided is not complete and is subject to change without notice. Product installation must adhere strictly to instructions accompanying product to avoid risk of fire and potential injury.

Additional information can be found online at www.monessenhearth.com



LOVE AT FIRST LIGHT

(877) 863-4350 | monessenhearth.com