

This Owner's Manual is provided and hosted by [Appliance Factory Parts](#).



Monessen Hearth ODCOUG-36 Owner's Manual

[Shop genuine replacement parts for Monessen Hearth
ODCOUG-36](#)



[Find Your Monessen Hearth Fireplace Parts - Select From 701 Models](#)

----- Manual continues below part list -----

Available Replacement Parts for Monessen Hearth ODCOUG-36

[593-592](#)

CONTROL MODULE

ODCOUG-36T

ODCOUG-36PT

ODCOUG-36PH

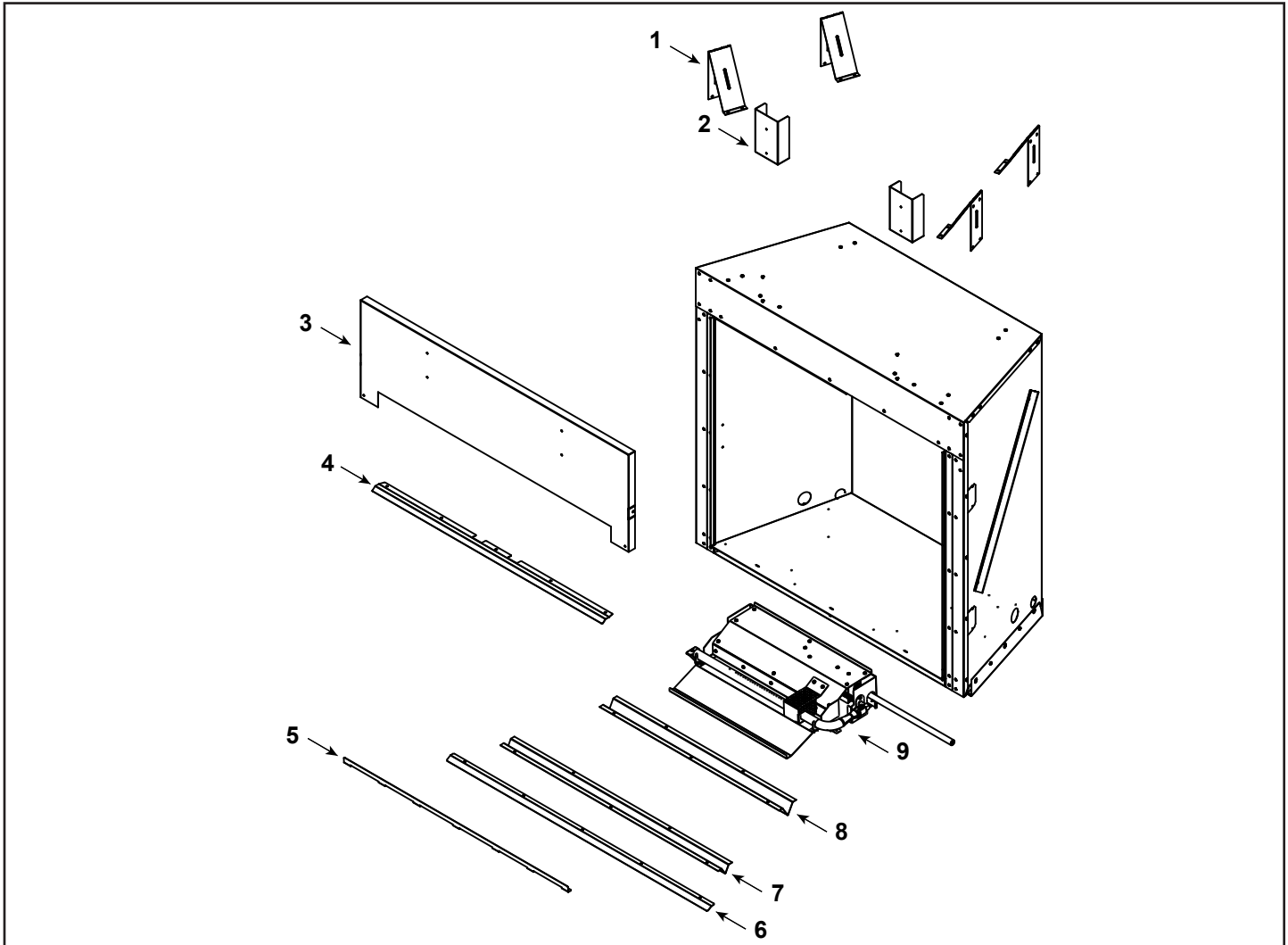

IMPORTANT: THIS IS DATED INFORMATION. Parts must be ordered from a dealer or distributor. **Hearth and Home Technologies does not sell directly to consumers.** Provide model number and serial number when requesting service parts from your dealer or distributor.



Stocked at Depot

ITEM	DESCRIPTION	COMMENTS	PART NUMBER	
1	Standoff, Tall	Qty 4 req	SRV4090-511	
2	Mounting Bracket	Qty 2 req	SRV4608-149	
3	Rain Shield		SRV4608-129	
4	Eyebrow		SRV4608-110	
5	Drain Lip		SRV4608-120	
6	Media Lip		SRV4608-122	
7	Standoff, Bottom Front		SRV4608-121	
8	Standoff, Bottom Rear		SRV4608-111	
	Screen Assembly	Qty 2 req	SRV4608-300	Y
	Screen Rod	Qty 2 req	4039-120	

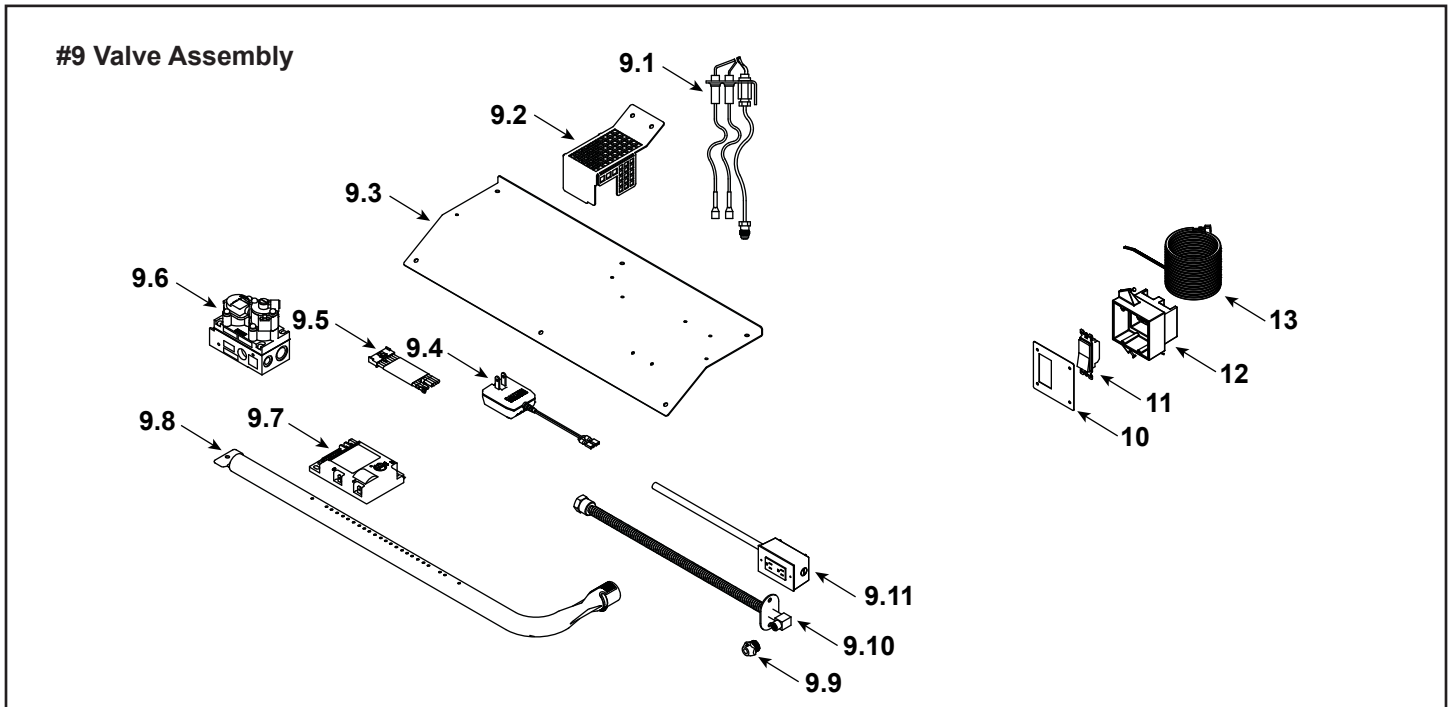

IMPORTANT: THIS IS DATED INFORMATION. Parts must be ordered from a dealer or distributor. **Hearth and Home Technologies does not sell directly to consumers.** Provide model number and serial number when requesting service parts from your dealer or distributor.



Stocked at Depot

ITEM	DESCRIPTION	COMMENTS	PART NUMBER	
9	Enginge Assembly		SRV4608-007	
9.1	Pilot		SRV593-512	Y
9.2	Pilot Shield		SRV4608-125	
9.3	Control Cover Plate		SRV4608-118	
9.4	Transformer, 3V		SRV593-593	Y
9.5	Wire Assembly		SRV593-590	Y
9.6	Valve Assembly		593-500	Y
9.7	Control Module		593-592	Y
9.8	Burner Tube		SRV4608-302	Y
9.9	Orifice, Burner		SRV4608-305	Y
9.10	Bulkhead w/Flextube		2166-119	Y
9.11	OD Outlet w/Harness		SRV4608-304	Y
	Flexline 18" w/Shutoff		SRV69D0030	Y
10	Mounting Plate		SRV4608-127	
11	Rocker Switch		20304686K	Y
12	Outdoor Outlet Box		SRV4021-117	
13	SCS Wall Switch Wire		20308590K	Y
	Log Pin (Ships with Grate Kit)	Qty 2 req	20306673K	

Additional service part numbers appear on following page.

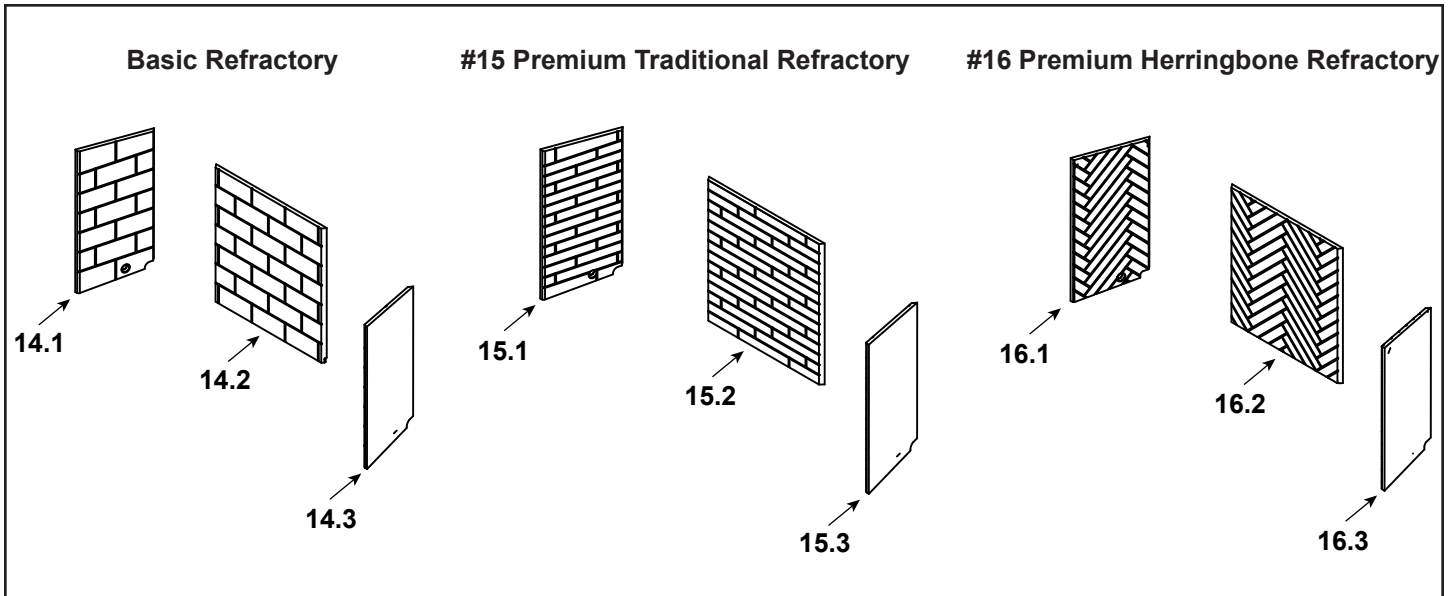

IMPORTANT: THIS IS DATED INFORMATION. Parts must be ordered from a dealer or distributor. **Hearth and Home Technologies does not sell directly to consumers.** Provide model number and serial number when requesting service parts from your dealer or distributor.



Stocked at Depot

ITEM	DESCRIPTION	COMMENTS	PART NUMBER	
14.1	Refractory Left, Basic		SRV4608-701	
14.2	Refractory Back, Basic		SRV4608-700	
14.3	Refractory Right, Basic		SRV4608-702	
15	Refractory Assembly, Premium Traditional		FBPREMT36	
15.1	Refractory Left, Premium Traditional		SRV4608-311	
15.2	Refractory Back, Premium Traditional		SRV4608-310	
15.3	Refractory Right, Premium Traditional		SRV4608-312	
16	Refractory Assembly, Premium Herringbone		FBPREMH36	
16.1	Refractory Left, Premium Herringbone		SRV4608-316	
16.2	Refractory Back, Premium Herringbone		SRV4608-315	
16.3	Refractory Right, Premium Herringbone		SRV4608-317	
	Overlay Kit		4608-010	
Conversion Kit				
	LP Conversion Kit		LPK-ODCOUG	Y
	Orific, #45C		582-845	Y
	Pilot Orifice, LP		SRV593-527	Y
	Regulator, LP		SRVLPK-DXF	Y
	Regulator, NG		SRVNGK-DXF	Y