

This Owner's Manual is provided and hosted by [Appliance Factory Parts](#).



# ProFire PFDLX36RIH Owner's Manual

[Shop genuine replacement parts for ProFire  
PFDLX36RIH](#)



[Find Your ProFire Grill Parts - Select From 68 Models](#)

----- Manual continues below -----

# ProFire® Grills

## *Perfection by Design*

### Owner's Manual & Installation Instructions

For questions about features, operation/performance, parts or service, call 888.781.4657 or  
Visit our website at [www.profiregrills.com](http://www.profiregrills.com)

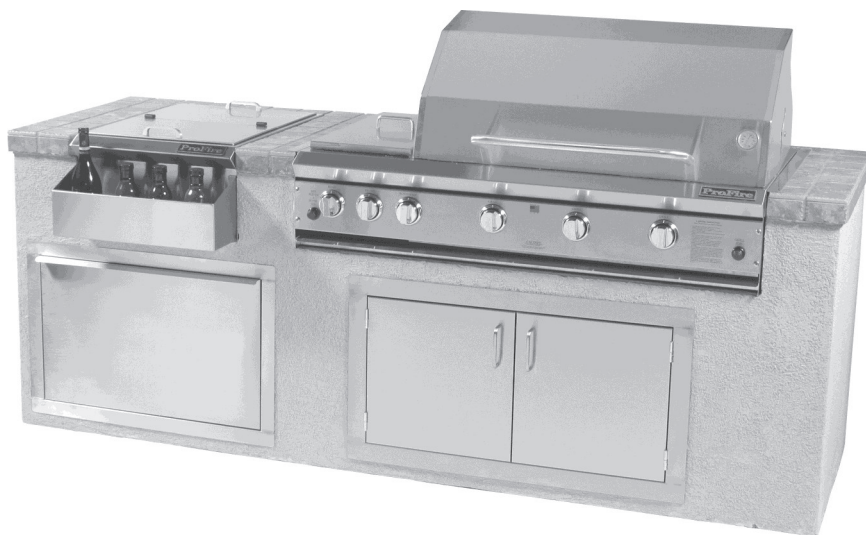

**GAS-FIRED**



**MH49347**

**LISTED**

**WARNING:** You must read this manual carefully and completely before using your grill to ensure proper operation, proper installation, proper servicing and to reduce the risk of fire, burn hazard and/ or other injury.

**⚠ DANGER**

If you smell gas:

1. Shut off gas to the appliance.
2. Extinguish any open flames.
3. Open lid.
4. If odor continues, keep away from the appliance and immediately call your gas supplier or your fire department.

Leaking gas may cause a fire or explosion which can cause serious bodily injury, death, or damage to property.

**⚠ WARNING**

1. Do not store or use gasoline or other flammable liquids or vapors in the vicinity of this or any other appliances.
2. An LP cylinder not connected for use shall not be stored in the vicinity of this or any other appliances.

**⚠ WARNING**

Follow all leak-check procedures carefully in this manual prior to barbecue operation. Do this even if the barbecue was dealer-assembled.

**⚠ WARNING**

**BEFORE LIGHTING:**

Do not ignite this appliance without first reading the Burner Ignition section of the manual.

**THIS GRILL IS FOR OUTDOOR USE ONLY.**

If your appliance is a LP unit and stored indoors, detach and leave LP cylinder outdoors.

**NOTICE TO INSTALLER:** These instructions must be left with the owner and the owner should keep them for future use.

***Congratulations!***

You have purchased the finest Gas grill ever built. Every effort has been made to use only the finest materials available and to design the grill to give many years of trouble free service. If you have any questions or comments please feel free to contact us at ProFire.

We thank you for buying the “Made In USA” professional ProFire Gas Grill.

**MODEL IDENTIFICATION**

Your ProFire Gas Grill is identified by a model number and a serial number. Always use both the model and serial numbers when contacting ProFire about your grill. For future reference, take the time now to record the model and serial numbers below:

**MODEL NUMBER** \_\_\_\_\_ **SERIAL NUMBER** \_\_\_\_\_













**DATE PURCHASED** \_\_\_\_\_

How to contact us phone: 888-781-4657, Fax: 888-781-3965, E-mail: [info@profiregrills.com](mailto:info@profiregrills.com) or write: Customer Service, ProFire Grills, 5565 North 124th Street, Butler, WI 53007.

## IMPORTANT SAFETY INFORMATION

### DANGER

**Failure to follow the Dangers, Warnings and Cautions contained in this Owner's Manual may result in serious bodily injury or death, or in a fire or an explosion causing damage to property.**

-  The installation of this appliance must conform with local codes or, in the absence of local codes, either the *National Fuel Gas Code, ANSIZ223.1/NFPA54* or *CAN/CGA-B149.1, Natural Gas Installation Code* or *CAN/CGA-B149.2, Propane Installation Code*.
-  The outdoor cooking gas appliance is not intended to be installed in or on recreational vehicles and/or boats. This outdoor cooking gas appliance is intended for use outdoors and shall not be used in a building, garage or any other enclosed area.
-  **Minimum clearance of 12 inches from the back and sides of the grill to adjacent combustible construction must be maintained. This outdoor cooking gas appliance shall not be located under overhead unprotected combustible construction.**
-  The utilization of an external electrical source requires that when installed, this outdoor cooking gas appliance must be electrically grounded in accordance with the local codes or, in the absence of local codes, with the National Electrical Code, ANSI/NFPA 70, or the Canadian Electrical Code, CSA C22.1. Keep any electrical supply cord, or the rotisserie motor cord and the fuel supply hose away from any heated surfaces.
-  Keep your grill in an area clear and free from combustible materials, gasoline and other flammable vapors and liquids.
-  DO NOT obstruct the flow of combustion and ventilation air to this appliance. Keep the ventilation openings of the enclosure free and clear from debris.
-  Check all gas connections for leaks with soapy water solution and brush. Never use an open flame. (Reference page 10 for leak test procedure).
-  Check flexible hoses for cuts and wear that may affect the safety before each use.
-  Never use charcoal in ProFire Gas Grill.
-  Never use the grill in a windy area.
-  Never use the grill without the drip pan installed and pushed all the way to the back of the grill. Without the drip pan, hot grease and debris could leak downward and produce a fire hazard.
-  The pressure regulator and hose assembly supplied with the ProFire Gas Grill must be used. Replacement pressure regulators and hose assemblies must be those specified by ProFire.
-  CALIFORNIA PROPOSITION 65-WARNING: The burning of gas cooking fuel generates some by-products which are on the list of substances known by the State of California to cause cancer or reproductive harm. California law requires businesses to warn customers of potential exposure to such substances. To minimize exposure to these substances always operate this unit according to the use and care manual, ensuring you provide good ventilation when cooking with gas.

**In Massachusetts: All gas products must be installed using a "Massachusetts" licensed plumber or gasfitter. A "T" handle type manual gas valve must be installed in the gas supply line to this appliance. This applies to permanently installed natural gas and propane installations. This does not apply to propane portable installations using a 20 pound tank.**

## **IMPORTANT GAS SAFETY INFORMATION**

Each appliance is set and tested at the factory for the type of gas supply to be used. Identify the type of gas, either Natural Gas or LP Gas and make sure that the marking on the data plate (rating plate) matches the gas being supplied to the grill.

All gas connections should be made by a qualified technician and in accordance with local codes and ordinances. The installation must conform with local codes or, in the absence of local codes, with either the National Fuel Gas Code, ANSIZ223.1NFPA 54, or CAN/CGA-B149.1, Natural Gas Installation Code or CAN/CGA-B149.2, Propane Installation Code.

**⚠ WARNING:**  
**CHECK TO ENSURE THAT THE GAS SUPPLY HOSE DOES NOT COME IN CONTACT WITH ANY HOT SURFACE OF THE GRILL**

**NEVER CONNECT THE GRILL TO AN UNREGULATED GAS SUPPLY.**

### **LP GAS (LIQUIFIED PETROLEUM/PROPANE)**

- ⚠** If your grill is factory built for LP gas, the regulator supplied is set for 11" water column and is for use with LP gas only. The factory-supplied regulator and hose must be used with a 20 lb. LP Cylinder.
- ⚠** Do not attempt to disconnect the gas regulator and hose assembly or any gas fitting while your grill is in operation.
- ⚠** A dented or rusty liquid propane cylinder may be hazardous and should be checked by your liquid propane supplier. Do not use a liquid propane cylinder with a damaged valve.
- ⚠** Although your liquid propane cylinder may appear to be empty, gas may still be present, and the cylinder should be transported and stored accordingly.
- ⚠** If you see, smell or hear the hiss of escaping gas from the liquid propane cylinder
  1. Move away from liquid propane cylinder.
  2. Do not attempt to correct the problem yourself.
  3. Call your fire department.

### **LP GAS SAFETY REQUIREMENT**

The LP Gas Supply Cylinder must be constructed and marked in accordance with the *Specifications for LP Gas Cylinders of the US Department of Transportation (D.O.T.) or the National Standards of Canada CAN/CSA-B339, Cylinders, Spheres and Tubes for the Transportations of Dangerous Goods, and Commission, as applicable and*

1. Provided with a listed overfilling prevention device.
2. Provided with a cylinder connection device compatible with the connection for outdoor cooking appliances.

It must be provided with a shut-off valve terminating in gas tank, valve outlet. It must include collar to protect the cylinder valve. The cylinder supply system must be arranged for vapor withdrawal.

**Do not operate the gas grill indoors or in any enclosed area. If the gas grill is not in use, the gas must be turned off at the supply cylinder. If the grill is to be stored indoors, disconnect the gas supply cylinder and leave the cylinder outdoors.**

**Only original factory parts should be used when repairing your grill. The use of unapproved or untested parts will void your warranty and may cause serious personal harm.**

## TABLE OF CONTENTS

INTRODUCTION.....	2
TABLE OF CONTENTS.....	5
SAFETY REQUIREMENTS.....	3,4
GAS REQUIREMENTS.....	6
NATURAL GAS HOOK-UP.....	7
L.P. HOOK UP AND TANK REQUIREMENTS.....	8
LOCATION REQUIREMENTS.....	9
CUT OUT DIMENSIONS.....	10
LEAK TESTING.....	11
ADJUSTING FOR PROPER FLAME.....	12
INSTALLATION CHECK-LIST.....	13
GRILL LIGHTING INSTRUCTIONS.....	14,15
USING YOUR ProFire GAS GRILL.....	16,17
Side burners.....	16,17
Rear broiler & rotisserie.....	17,18
CARE & MAINTENANCE.....	19,20
TROUBLESHOOTING.....	20
PARTS LIST & DIAGRAM.....	21
WARRANTY.....	22
INDEX.....	23

## GAS REQUIREMENTS

Verify the type of gas supply to be used, either Natural or L.P., and make sure the marking on the appliance rating plate agrees with that of the supply. The rating plate is located on the rear of the grill behind the side burners or on the right side behind the faceplate. An "X" will be marked next to the type of gas that the unit is orifice for.

L.P. gas installation requires the use of a regulator set for 11"W.C. pressure. Natural gas installation requires a pressure of 7"W.C.

An installer supplied gas shut-off valve must be installed in an easily accessible location. All installer supplied parts must conform to local codes, or in the absence of local codes, with the latest edition of the National Fuel Gas Code, ANSI Z223.1

All pipe sealants must be an approved type and resistant to the actions of L.P. and Natural gases. Never use pipe sealant on flare fittings. All gas connections should be made by a competent technician and in accordance with local codes and ordinances. In the absence of local codes, the installation must comply with the latest edition of the National Fuel Gas Code, ANSI Z223.1

Gas conversion kits are available from your dealer or ProFire. When ordering have available the model number, and type of gas (L.P. or Natural) which you need the ProFire grill orificed for. To convert to LP gas the model # will be GCKLP followed by the model # of your grill. To convert to Natural gas the model # will be GCKNAT followed by the model number of your grill.

TOTAL GAS CONSUMPTION of the ProFire gas grill with all burners on "HIGH":			
MODEL	BTU	MODEL	BTU
48G	88,000	36G	66,000
48S	96,000	36R	79,500
48R	101,500	40S	74,000
48RS	109,500	40R	87,500
27G	44,000	SINGLE SIDE BURNER	15,000
27R	57,500	DOUBLE SIDE BURNER	30,000

The appliance and its individual shut-off valve must be disconnected from the gas supply piping system during any pressure testing of that system at test pressures in excess of 1/2 PSIG (3.5kPa.). This appliance must be isolated from the gas supply piping system by closing its individual manual shut-off valve during any pressure testing of the gas supply piping system at test pressures equal to or less than 1/2 PSIG (3.5kPa.).

The installation of this appliance must conform with local codes or, in the absence of local codes, to the latest edition of the National Fuel Gas Code, ANSI Z223.1. Installation in Canada must be in accordance with the Standard Can1-b149.1 or .2 (installation code for gas burning appliances and equipment) and local codes.

## **GAS REQUIREMENTS**

### **NATURAL GAS HOOK-UP**

Connection: 3/8-flare male fitting in left rear corner of unit  
Operating pressure :7.0" W.C.

Check with your local gas utility company or with local codes for instructions on installing gas supply lines. Be sure to check on type and size of run, and how deep to bury the line. If the line is too small the ProFire gas grill will not function properly. Any joint sealant used must be an approved type and be resistant to actions of L.P. and Natural gases. Do not forget to place the installer supplied gas valve in an accessible location. Check local codes. Consult your local gas dealer. In the absence of local codes, installation must conform to the latest edition of the NATIONAL FUEL GAS CODE, ANSI Z233.1

The grill is designed to operate on Natural Gas at a pressure of 7" water column (W.C.) (1.75kPa) unregulated. Check with your gas utility for local gas pressure. Use of your grill at pressures other than approximate 7" water column could affect the performance of your grill and requires installation of a natural gas regulator set at 7" W.C.

The grill and its individual shut-off valve must be disconnected from the gas supply piping system during any pressure testing of that system at test pressures in excess of 1/2 psig (3.5kPa). The grill must be isolated from the gas by closing its valves during any pressure testing of the gas supply system at test pressures equal to or less than 1/2 psig (3.5kPa).

**Never use LP gas in a unit designed for natural gas. If you wish to convert your grill from one type of gas to the other you may order a gas conversion kit from ProFire or your dealer.**

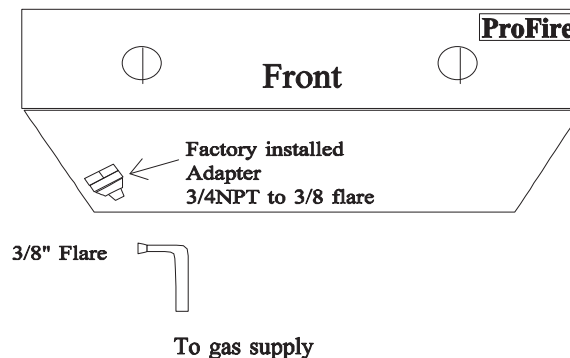

## LP GAS CONNECTION AND TANK REQUIREMENTS

A dented or rusty L.P. tank may be hazardous and should be checked by your L.P. supplier. Never use a cylinder with a damaged valve. Cylinder dimensions should be approximately 12 inches in diameter & 18" inches high. The L.P. cylinder must be constructed and marked in accordance with the specifications for L.P. gas cylinders of the U.S. Department of Transportation (DOT) or the National Standard of Canada, CAN/CSA-B339, Cylinders, Spheres and Tubes for Transportation of Dangerous Goods.

The propane gas cylinder valve must be equipped with a cylinder connection coupling device, described as Type 1 in the Harmonized ANSI standard ANSI Z 21.58 & CGA 1.6-M95-1995 with addenda Z 21.58. This device is commonly described as an *Acme Thread Quick Coupler* (see figure 1 below). The gas must be turned off at the supply cylinder when the unit is not in use. If the appliance is stored indoors the cylinder must be disconnected and removed from the appliance. Cylinders must be stored outdoors in a well-ventilated area out of the reach of children.

The cylinder supply system must be arranged for vapor withdrawal and must include a collar to protect the cylinder valve. Disconnected cylinders must not be stored in a building, garage, or any other enclosed area. The grill is designed to operate on Propane gas regulated at a gas pressure of 11" water column (W.C.) (2.7kPa). A regulator adjusted to this pressure must be installed in the gas supply line before the grill is connected to the propane source. Use only the type regulator and hose specified by ProFire.

Only 20 lb. cylinders equipped with an OPD (Overfill Protection Device) should be used with your ProFire grill. Only one propane cylinder may be located in an enclosure or cart. Extra spare cylinders must be stored outdoors out of the reach of children and outside of any building, garage or other enclosed area. **READ AND FOLLOW ALL WARNINGS PROVIDED WITH PROPANE CYLINDERS.** Never locate a cylinder under or near the barbecue unless sufficient ventilation & shielding is provided to prevent any heating of the cylinder, regulator and hoses.

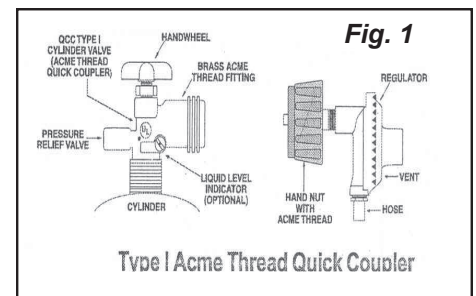
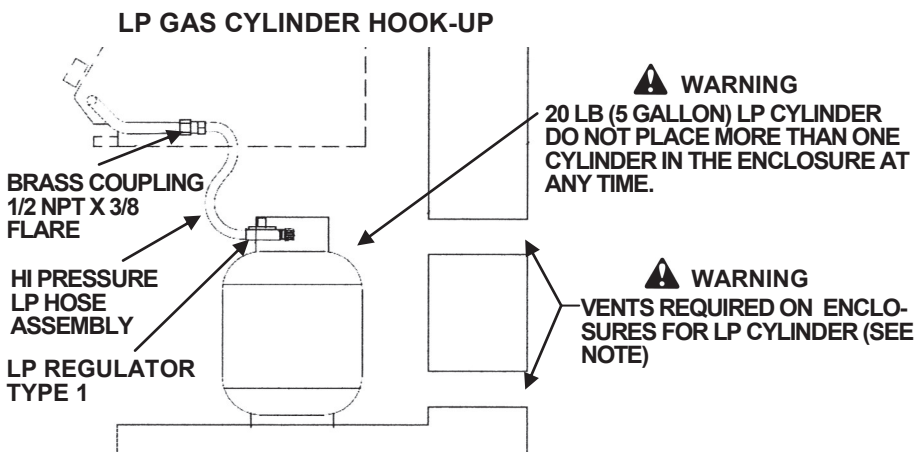

**CAUTION:** PROVIDE ADEQUATE VENTILATION HOLES (OPENINGS) IN THE ENCLOSURE FOR SAFETY PURPOSES IN THE EVENT OF A GAS LEAK.

**NOTE:** An enclosure for LP gas cylinder must be vented on the level of the cylinder valve and at floor level. The effectiveness of the opening(s) for purposes of ventilation shall be determined with the LP gas supply cylinder in place. This shall be accomplished by one of the following:

- A. One side of the enclosure shall be fully open; or
- B. For a cylinder enclosure having four sides, a top and a bottom, and intended for installation in a built-in enclosure.
  1. At least one ventilation opening shall be provided on the exposed exterior side of the enclosure located within 5 inches (1.27mm) of the top of the enclosure and unobstructed. The opening(s) shall have a total free area of not less than 1 in<sup>2</sup>/lb (14.2 cm<sup>2</sup>/kg) of stored fuel capacity.
  2. At least one ventilation opening shall be provided on the exposed, exterior side of enclosure 1 in. (25.4mm) or less from the floor level and shall have a total free area of not less than 1/2 in<sup>2</sup>/lb (7.1 cm<sup>2</sup>/kg) of stored fuel capacity. The edge shall be no more than 5 in (127mm) above the floor level.
  3. Every opening shall have a minimum dimension so as to permit the entrance of 1" x 1/8 in (3.2mm) rod.

## **LOCATION REQUIREMENTS**

### **Propane Cylinder Ventilation Requirements (See Page 8)**

#### **Household Propane Service**

It is recommended that the same ventilation requirements be used for household propane service as propane cylinders.

#### **Clearance to combustible construction**

Minimum clearance from sides and back of unit to adjacent combustible construction below top of unit, 12" from sides and back. Minimum horizontal clearance from sides and back of unit to adjacent vertical combustible construction extending above top of unit 12" from sides and back.

#### **Clearance to non-combustible construction**

It is desirable to allow at least 6" side clearance to non-combustible construction above the cooking surface for counter space. When using the rotisserie the space is essential for the motor and skewer clearance. The ProFire gas grill can be placed directly adjacent to non-combustible construction below the cooking surface.

#### **Insulated Sleeve**

If the ProFire gas grill is to be placed into a combustible enclosure an approved insulated sleeve is necessary and is available from your dealer. Use only the ProFire insulated sleeve which has been designed and tested for this purpose.

#### **Location**

When determining a suitable location take into account concerns such as exposure to wind, proximity to traffic paths and keeping any gas supply lines as short as possible. Locate the grill only in a well-ventilated area. Never locate the grill in a building, garage, breezeway, shed or other such enclosed areas without an approved ventilation system. During heavy use the grill will produce a lot of smoke. Ensure that there is adequate area for smoke to dissipate.

#### **Ventilation Hood**

When installing your grill under overhead unprotected areas the use of a ventilation hood with a minimum of 600CFM (1200 CFM for 48" ProFire units) is necessary. A proper ventilation hood is available from your dealer or from ProFire.

## GRILL AND ACCESSORY CUT-OUT DIMENSIONS FOR BUILT-INS

### ProFire Cutout Dimensions

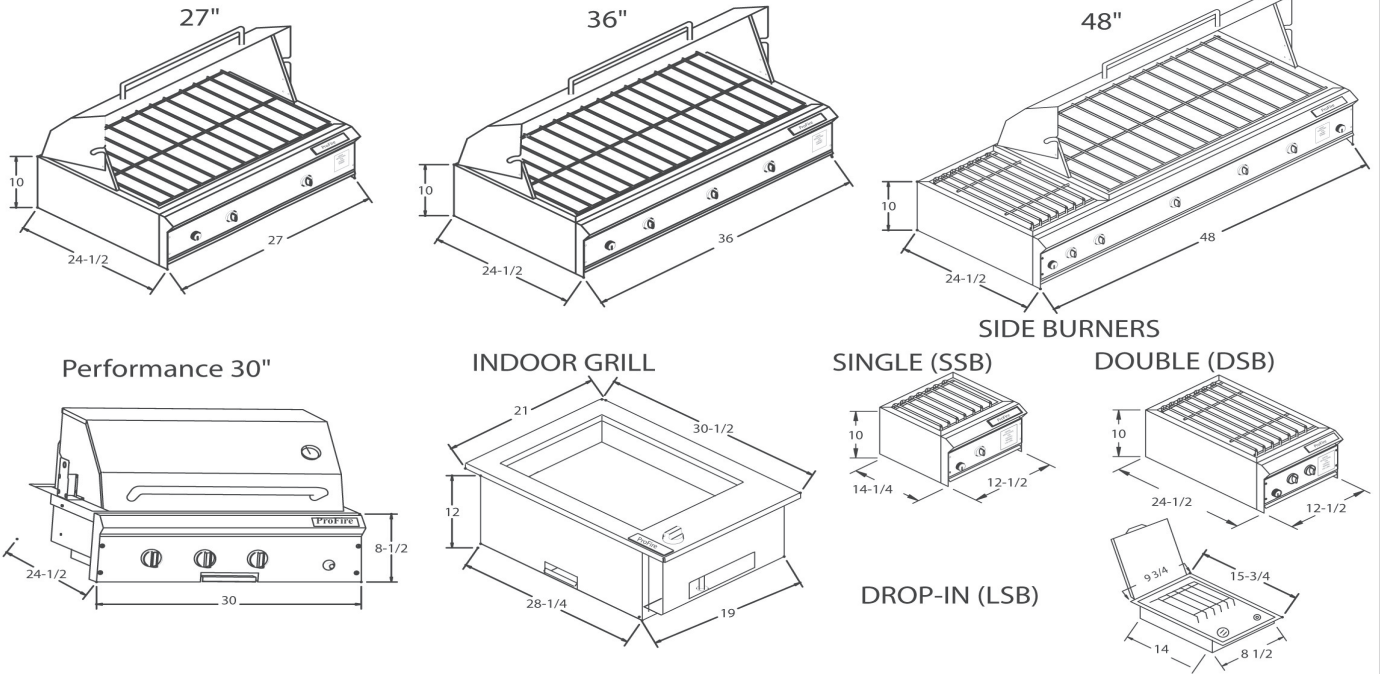

NON COMBUSTIBLE CUTOUT DIMENSIONS				INSULATED SLEEVE CUTOUT DIMENSIONS				
MODEL	A	B *	C	MODEL	A	B	C	D *
27"GRILL	27-1/4"	23 <sup>*</sup> / 24-1/2"	10"	27"GRILL	30"	24-1/2"	11-1/8"	31-1/2"
30"GRILL	26-3/4"	** 19-3/4"	8-5/8"	30"GRILL	29-1/4"	21"	9-3/4"	31"
36"GRILL	36-1/4"	23 <sup>*</sup> / 24-1/2"	10"	36"GRILL	39"	24-1/2"	11-1/8"	40-1/2"
48"GRILL	48-1/4"	23 <sup>*</sup> / 24-1/2"	10"	48"GRILL	51"	24-1/2"	11-1/8"	52-1/2"
DOUBLE SIDE BURNER	12-3/4"	23 <sup>*</sup> / 24-1/2"	10"	DOUBLE SIDE BURNER	15-3/4"	24-1/2"	11-1/8"	17-1/4"
SINGLE SIDE BURNER	12-3/4"	12-3/4 <sup>*</sup> / 14-1/4"	10"	SINGLE SIDE BURNER	15-3/4"	14"	11-1/8"	17-1/4"
DROP-IN SINGLE SIDE BURNER	14-1/4"	8-3/4"	D* Overhanging countertop cutout dimension is for use with the INSULATED SLEEVE ONLY					
INDOOR GRILL	28-3/8"	19-3/8"						

B\* 23" Depth for projected facing  
 24-1/2" Depth for flush facing  
 (12-3/4" Depth for single side burner projected facing)  
 \*\* 30" Grill requires 30-1/4" cutout in overhanging countertop(D)

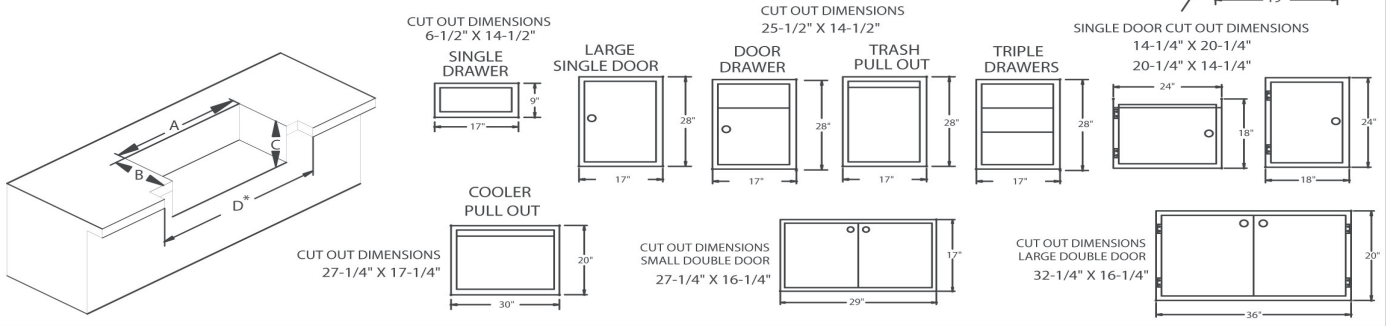

## **LEAK TESTING**

### **CHECK ALL GAS SUPPLY FITTINGS FOR LEAKS BEFORE EACH USE.**

Keep a spray bottle of soapy water near the shut-off valve of the gas supply valve. Spray all the fittings. Bubbles indicate leaks. Although all gas connections on the ProFire grill are leak tested at the factory prior to shipment a complete gas tightness check must be performed at the installation site due to possible mishandling in shipment, or excessive pressure unknowingly being applied to the unit. Periodically check the whole system for leaks, or immediately check if the smell of gas is detected.

### **DO NOT SMOKE WHILE LEAK TESTING. EXTINGUISH ALL OPEN FLAMES.**

### **NEVER LEAK TEST WITH AN OPEN FLAME.**

Make a soap solution of one part liquid detergent and one part water. You will need a spray bottle, brush, or rag to apply the solution to the fittings. For L.P. units, check with a full cylinder. The valve panel must be removed to check the valves and fittings. Remove the knobs. Then remove the screws which fasten the valve panel to the unit. Pull the valve panel outward and unplug the wires from the back of the rotary igniter. If your grill has the optional rear broiler, remove the screws which hold the inspection cover in place.

### **TO TEST**

Make sure all control valves are in the "OFF" position. Turn the gas supply "ON". Check all connections from the supply line, or L.P. cylinder up to and including the manifold pipe assembly. Apply the soap solution around all connections, valves, and tubing. Soap bubbles will appear where there is a leak present. If a leak is present, immediately turn off gas supply, tighten any leaking fittings, turn gas on, and recheck.

### **WARNING**

**IF YOU CANNOT STOP A GAS LEAK TURN OFF THE GAS SUPPLY AND CALL YOUR LOCAL GAS UTILITY, OR THE DEALER YOU PURCHASED THE APPLIANCE FROM.**

**Only those parts recommended by the manufacturer should be used on the ProFire gas grill. Substitutions will void the warranty.**

**Do not use the ProFire gas grill until all connections have been checked and do not leak.**

## ADJUSTING FOR PROPER FLAME AND EFFICIENCY

Each burner is tested and adjusted at the factory prior to shipment. However, variations in the local gas supply or conversion from one gas to another may make it necessary to adjust the burners. The flames of the grill burners should be visually checked. The rear broiler (when equipped) should have a very low flame (no more than 1/4") and glow with a light red color. There is no air shutter adjustment for the rear broiler. On the main burners and side burners the flames should be blue and stable with small yellow tips and no excessive noise or lifting. If the burners do not operate correctly, check if the air shutter or burner ports are blocked by dirt, debris, spider webs, etc. and proceed with air shutter adjustment. The amount of air which is drawn into a burner is governed by a metal cup at the inlet of the burner called an air shutter. It is locked in place by a screw, which must be loosened prior to lighting the burner for adjustment. To access the grill burner air shutters, first, remove the valve panel by removing the screws on the corners of the valve panel. Remove the control knobs. Pull the valve panel outwards while unplugging the rotary ignitors. With a screwdriver, loosen the screw on the side of the air shutter. Light the burner and adjust according to the directions below. Access and adjustment of the side burner air shutters is done in the same manner as the main burners.

### BURNER AIR ADJUSTMENT

#### BE CAREFUL AS THE BURNER MAY BE VERY HOT!

A *yellow flame* indicates insufficient air: Open the air shutter to allow more air to the burner.  
*Flame is noisy, blows out, or lifts away from burner or will not light*, this indicates too much air: Close the air shutter. *Once the air shutter is adjusted* turn the burner off and reverse steps to reassemble.

Figure 11-1

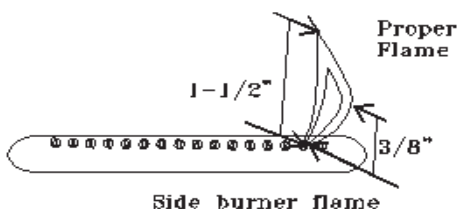
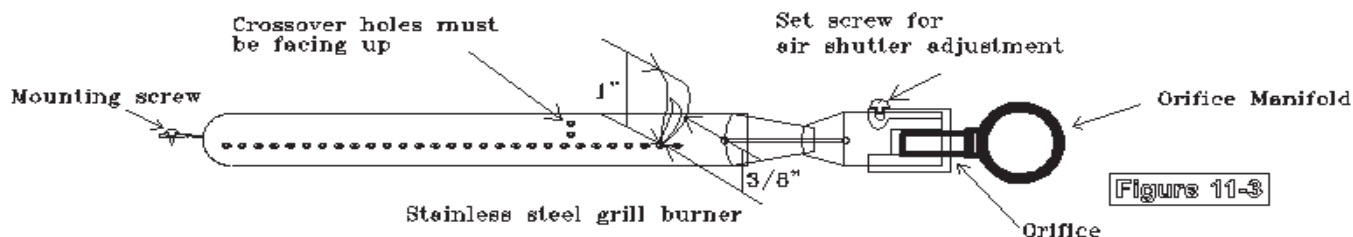
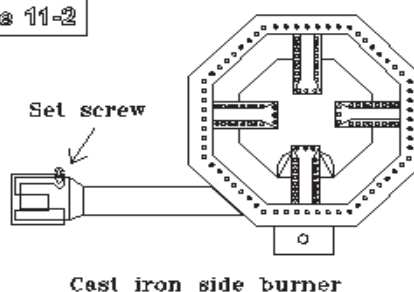

Figure 11-2



## INSTALLATION CHECK LIST

**NOTE TO THE INSTALLER: BE SURE ALL ITEMS ON THIS LIST HAVE BEEN THOROUGHLY COMPLETED AND CHECKED BEFORE OPERATING THE GRILL.**

- \_\_\_\_\_ Specified clearances maintained to combustibles.
- \_\_\_\_\_ If grill is installed in an island, ventilation openings are provided in island.
- \_\_\_\_\_ All internal packaging removed.
- \_\_\_\_\_ Knobs turn freely and bezels centered.
- \_\_\_\_\_ Each burner lights satisfactorily, individually or with adjacent burner lit.
- \_\_\_\_\_ Air shutters adjusted.
- \_\_\_\_\_ Adjustable low setting satisfactory.
- \_\_\_\_\_ Drip pan in place properly and sliding freely.
- \_\_\_\_\_ Pressure regulator connected and set for 11.0"W.C. for L.P. gas.
- \_\_\_\_\_ Pressure checked and set at 7.0"W.C. for natural gas.
- \_\_\_\_\_ Manual shut off valve installed and accessible.
- \_\_\_\_\_ Unit tested and free of gas leaks.
- \_\_\_\_\_ User informed of gas supply shut off valve location.

**INSTALLER: PLEASE LEAVE THESE INSTRUCTIONS WITH THE USER.  
USER: PLEASE RETAIN THESE INSTRUCTIONS IN A SAFE PLACE FOR  
FUTURE USE.**

**Installer Signature** \_\_\_\_\_ **Date of completion** \_\_\_\_\_

## HOW TO LIGHT YOUR GAS GRILL

### **WARNING**

**Before lighting your grill be sure to read this section carefully.**

#### **Turn all knobs to the off position then:**

Inspect the gas supply piping or hose prior to turning the gas on. If there is evidence of cuts, wear, or abrasion, it must be replaced prior to use. The replacement pressure regulators and hose assembly must be the type specified by the manufacturer. Do not use the ProFire gas grill if the odor of gas is present.

For L.P. gas, the pressure regulator and hose assembly supplied with the unit must be used. Install the regulator into the tank and check the hose and regulator connections for leakage with a soap and water solution before operating your ProFire gas grill. Be sure there is gas in the tank.

** DANGER: Failure to open the lid while igniting the grill, or not waiting 5 minutes to allow the gas to clear if the grill does not light, may result in an explosive flare-up which can cause serious bodily injury or death.**

** WARNING: WHEN LIGHTING YOUR GRILL ALWAYS KEEP YOUR FACE AND BODY AS FAR AWAY FROM THE GRILL AS POSSIBLE.**

#### **LIGHTING THE GRILL BURNERS**

1. Make sure all knobs are in the "OFF" position.
2. OPEN THE LID and/or remove the side burner cover.
3. Open the gas supply shut-off valve.
4. Push in and turn the burner knob to "LIGHT".
5. Push the ignitor button for 4 seconds button. You will hear a snapping sound, indicating that a spark is being delivered to the burner.
6. If the burner does not light in 4 seconds, turn the knob to "OFF" and wait 5 minutes before repeating steps 4 and 5.

#### **MATCH LIGHTING INSTRUCTIONS:**

If the ignitor will not light the burners, the burners can be lit manually using a lighted long match, or BBQ lighter.

- A. Push in and turn the knob to light.
  - B. Insert a lit match or BBQ lighter thru the cooking grid to the burners below the flavor grid and push-in and turn knob to "LIGHT".
7. If grill does not light, turn all knobs to "OFF" and have a qualified service technician check the grill.
  8. Turn all knobs to "OFF" and shut off gas supply when not in use.

** WARNING: If you smell gas, shutoff the gas supply and immediately check for leaks using the soapy water technique.**

**NOTICE:** On the initial use light the grill and let it run on "HIGH" for 15-20 minutes to burn off residues from the factory.

**TO PREHEAT GRILL BEFORE COOKING:** Open the lid. Light the grill, close the lid and heat on "HIGH" for 10 minutes.

## HOW TO LIGHT YOUR GAS GRILL

### LIGHTING THE SIDE BURNERS

**⚠ DANGER:** Failure to open the lid while igniting the grill, or not waiting 5 minutes to allow the gas to clear if the grill does not light, may result in an explosive flare-up which can cause serious bodily injury or death.

**⚠ WARNING:** WHEN LIGHTING YOUR GRILL ALWAYS KEEP YOUR FACE AND BODY AS FAR AWAY FROM THE GRILL AS POSSIBLE.

1. Remove the burner cover and any cooking utensils from the burner grate.
2. Push and turn the burner control knob to the "LIGHT" position and immediately push the ignitor button (marked side burner) for 4 seconds or until the burner is lit. If the burner does not light in 4 seconds turn the burner control knob to "OFF" and wait at least 5 minutes for the gas to dissipate before trying to light again.
3. The side burner can also be lit with a long match or match holder if the ignitor fails to light the burner.
4. To light with a match or match holder, hold the lighted match next to the burner ports and turn the burner control knob to "LIGHT". Remove and extinguish the match quickly when the burner lights.

**Lighting the side burner**

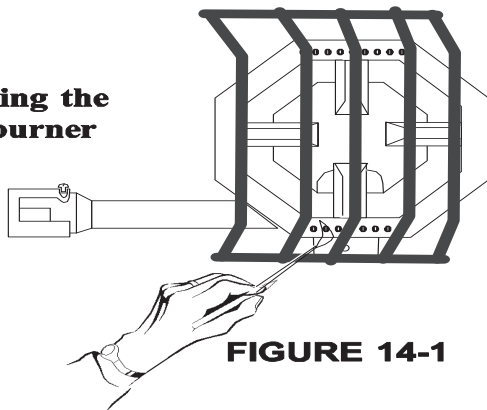

**FIGURE 14-1**

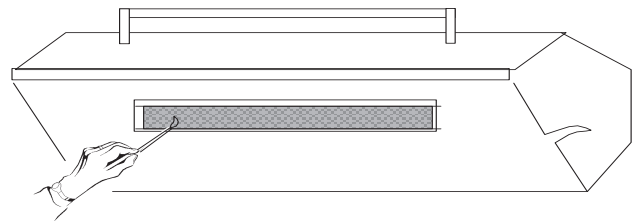

**Lighting the rear broiler burner**

**FIGURE 14-2**

### LIGHTING THE REAR BROILER DO NOT USE DURING WINDY CONDITIONS

Because of the location of the rear broiler it is easily susceptible to windy conditions.

1. **OPEN THE LID.** Push and turn the rotisserie burner control knob to "LIGHT".
2. Push the igniter button (marked rotisserie) You will hear a snapping sound indicating that a spark is being delivered to the burner.
3. If the burner does not light in 4 seconds, turn the knob to "OFF" and wait 5 minutes before trying to light again.
4. If the ignitor does not light the burner it may be lit with a long stemmed match or match holder. Hold the match next to the burner then turn burner control knob to "LIGHT". relighting a hot burner, wait 5 minutes.

## USING YOUR PROFIRE GAS GRILL

### TO BEGIN:

1. Be sure the drip pan is in place and pushed all the way to the back of the grill.
2. Light the burners using the instructions given.
3. PREHEAT the grill after lighting with burner control knob turned to "HIGH" for 5 minutes.  
Keep the lid closed while preheating.
4. Place the food on the grill and cook to the desired doneness. Adjust the heat setting if necessary.  
The burner control knob may be set to any position between "HIGH" and "LOW".
5. Turn all knobs of "OFF" and shut off gas supply when you are finished grilling.
6. Clean the cooking grids and drip pan after each use.

Grilling requires high heat for searing and proper browning. Most foods are cooked at the highest heat setting for the entire cooking time. However, when grilling large pieces of meat or poultry, it may be necessary to turn the heat to a lower setting after the initial browning, this will cook the food completely through without burning the outside. Foods cooked for a long time or basted with a sugary marinade may need a lower heat setting near the end of the cooking time. The doneness of the meat, whether rare, medium, or well done, is affected to a large degree by the thickness of the cut. Trim any excess fat from the meat before cooking. To prevent steaks or chops from curling during cooking, slit the fat around the edges at 2-inch intervals. When defrosting meats, it is recommended that it be done overnight in a refrigerator as opposed to a microwave as the microwave can dry out or even partially cook the meat.

### TO AVOID FLARE-UPS CHICKEN SHOULD BE COOKED ON THE MEDIUM OR LOW SETTING

#### DUAL PURPOSE THERMOMETER

All ProFire grills come equipped with a dual purpose thermometer which may be left in place to read the air temperature inside of the closed lid or it can be removed and inserted into the meat that you are grilling.

**NEVER ALLOW THE AIR TEMPERATURE INSIDE THE GRILL TO GO ABOVE 500°F.**

#### CHART FOR DESIRED DONENESS

Insert thermometer directly into center of meat to check for doneness.

#### Safe Minimum Cooking Temperatures

Category	Food	Temperature (°F)	Rest Time*
Ground Meats	Beef, Pork, Veal, Lamb,	160	None
Meat Mixtures	Turkey, Chicken	165	None
Fresh Beef, Veal	Steaks, Roast	145	3 Minutes
Lamb	Chops	145	3 Minutes
Poultry	Chicken & Turkey, Whole	165	None
	Poultry Breast, Roasts	165	None
	Poultry Thighs, Legs, Wings	165	None
	Duck & Goose	165	None
Pork & Ham	Stuffing (cooked alone or in bird)	165	None
	Fresh Pork	145	3 Minutes
	Fresh Ham (raw)	145	3 Minutes
Sausage	Precooked Ham (to reheat)	140	None
	Fresh Bratwurst, Italian & Polish	170	None
Eggs & Egg Dishes	Eggs- Cook Until Yolk and Whites Are Firm		None
	Egg Dishes	160	None
Seafood	Fin Fish	145 (Cook Until Flesh is Opaque and Separates Easily With a Fork)	
	Shrimp, Lobster, and Crabs	Cook Until Flesh is Pearly and Opaque	
	Clams, Oysters, and Mussels	Cook Until Shells Open During Cooking	
	Scallops	Cook Until Scallops Turn Milky White or Opaque and Firm	

\*After you remove meat from the grill, allow it to rest for the specified amount of time.

## USING YOUR PROFIRE GAS GRILL

### FLAVOR GRID

An exclusive feature of the ProFire gas grill is its stainless steel flavor grid designed to deflect the grease from falling into the burners thereby preventing flare-ups and extending the life of the burners. The perforations in the stainless steel evens out the heat and creates a hot surface for the meat drippings to fall on to. This action turns the drippings into smoke, which passes over the meat resulting in a delicious "**charcoal flavor**".

### THE SMOKER BOX

Most ProFire gas grills include a built-in smoker box installed directly onto the flavor grid because we believe that wood chips enhance the flavor of everything that is grilled. To use the smoker box place a handful of water soaked wood chips in the box then ignite the burner directly under the box to "HIGH" for 10 minutes. Then reduce the flame to medium or low to keep the chips from burning up too fast.

**CAUTION:** When adding more chips to the box when the grill is hot, care must be taken to avoid burns as the cooking grid must be lifted.

### COMMERCIAL RANGE TOP BURNERS

Your ProFire gas grill maybe equipped with commercial style burners. Each is rated at 15,000 BTU and has a spark ignitor for easy lighting. Provided for use with your side burners is a stainless steel cover which doubles as work surface when the burners are not in use. When using the Grill with the side burners covered, be careful as heat can conduct from the grill and cause the cover to heat up. Always remove the cover before lighting the side burners.

**⚠ WARNING: NEVER LIGHT OR USE THE SIDE BURNERS WITH THE COVER IN PLACE.**

### FLAME HEIGHT

The correct height of the flame depends on the size and material of the utensil being used, the food being cooked, and how much liquid is in the utensil.

*The flame should never extend beyond the bottom of the pan.*

### REMOVING AND REPLACING THE BATTERY IN THE IGNITORS

1. Unscrew the plastic nut on the front of the ignitor.
2. Insert a AAA battery making sure the + side faces in.
3. Screw the black plastic nut back on.

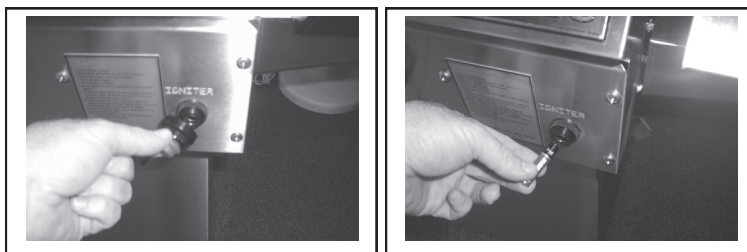

## USING YOUR PROFIRE GAS GRILL

### ROTISSERIE & REAR BROILER

The rear broiler is an infrared type, which provides intense searing radiant heat. Preferred by professional chefs over other methods, this intense heat is perfect for searing in the natural juices and nutrients found in quality cuts of meats. When lit, the rear broiler will reach cooking temperatures in about 3 minutes. The orange/red glow will even out in about 5 minutes.

The rotisserie motor is equipped with gears capable of turning up to a 12-lb. cut of meat or poultry. The motor is mounted to a stainless steel bracket, which attaches to the right side of the grill. The rotisserie motor must be electrically grounded in accordance with local codes or, in the absence of local codes, with the National Electrical Code, ANSI/NFPA 70-1990. Warning: This appliance is equipped with a three-prong (grounding) plug for your protection against shock hazard and should be plugged directly into a properly grounded three-prong receptacle. Do not cut or remove the grounding prong from this plug.

The skewer for the rotisserie fits into the motor assembly by placing the pointed end into the motor and the other end on the support at the left side of the grill. With the skewer pushed in as far as possible into the motor, the grooved skewer bushing should rest on the left side bracket. The removable handle should only be in place when handling the skewer.

**WHEN USING THE SIDE BURNERS  
REMOVE THE SKEWER HANDLE TO PREVENT IT FROM GETTING HOT!**

To load the skewer begin with the handle in place, and slide one of the meat holders with prongs facing away from the handle onto the skewer. Push the skewer through the center of the food, then slide the second meat holder with prongs towards the food onto the skewer. Center the food on the skewer then push the meat holders firmly into the food. Tighten the wing nuts. It may be necessary to wrap the food with butchers string (never use nylon or plastic string) to secure any loose portions.

Once the food is secure insert the skewer into the motor. If needed, remove the grill racks. Place a basting pan under the food. It is normal for the skewer to flex when large cuts of meats are being cooked. However, the ProFire system will accommodate most cuts of meat without needing to remove the cooking grids.

NOTE: After the first use of your rear broiler it is likely that the stainless steel above the burner will darken to a dark blue color. The electric motor should be removed and stored in a dry place when not in use.

 **WARNING**

**DO NOT USE THE REAR BROILER AND THE BOTTOM BURNERS AT THE SAME TIME!**

## **CARE AND MAINTENANCE**

### **STAINLESS STEEL**

The ProFire gas grill is made from non-rusting, non-magnetic, type 304 stainless steel. There are many different stainless steel cleaners available. Always use the mildest cleaning methods first, scrubbing in the direction of the grain. To touch up noticeable scratches in the stainless steel, sand lightly with dry 100 grit emery paper or scotch bright pad in the direction of the grain. Specks of grease can gather on the surfaces of the stainless steel and bake on to the surface giving the appearance of rust. To remove this grease buildup scrub with a strong degreaser in the direction of the grain. **IMPORTANT:** Coat the outer surface of your grill with lemon oil or a Stainless Shine product such as Sheila Shine. WD 40 also works well to coat the outer finish of your grill. Never clean your grill with soap and water or degreaser without coating the outer surface of your grill when you're finished.

### **COOKING GRIDS**

The easiest way to clean the grill is immediately after cooking is completed. Be sure the burners are turned off and there are no flames before beginning. Wear a barbecue mitt to protect your hand from the heat. Using a brass bristle barbecue brush, scrub the hot grids. If the grill is allowed to cool before cleaning, the cleaning process will be more difficult.

### **SIDE BURNER GRATES**

The side burner grates are stainless steel. Do not attempt to clean a hot grate. When the grate cools it may be wiped with hot, soapy water, then rinsed and wiped dry. Never immerse a hot grate in water as the hot steam produced could cause burns.

### **DRIP TRAY**

The drip tray will collect grease from the grill area and spills from the side burners. Do not attempt to remove or clean until thoroughly cooled. To avoid grease fires or flare-ups, be sure to clean out the grease often.

### **GRILL BURNERS**

The burners are constructed of stainless steel and should only require minimal maintenance. However, they should be checked every 6 months and cleaned if needed.

1. Shut off gas supply and make sure the grill is cool before attempting to check the burners.
2. Remove the cooking grids, then lift out the flavor grid.
3. Remove the mounting screw holding the burner in place then lift the burner up and forward so that the burner is pulled away from the valve. (See Page 12)

## **CARE AND MAINTENANCE**

### **SIDE BURNERS**

The side burners are constructed of cast iron with a high heat black coating. Occasional cleaning of the burner ports will be necessary. (See page 11, 16) The burners can be repainted using high heat paint. This will seal the cast iron and help prevent rust.

### **CLEANING THE BURNERS**

#### **After removing:**

1. Clean the exterior of the burner with a wire brush.
2. Clear any clogged ports with a straightened paper clip.
3. Never use a wooden toothpick as it may break off and clog the port.
4. Shake out any debris through the air shutter.
5. Use a flashlight to inspect the burner inlet to ensure it is not blocked.
6. If an obstruction can be seen, use a straightened metal wire coat-hanger to clean it out.

### **CLEANING THE ORIFICES**

No regular maintenance should be needed for the orifices. They should only be removed if it is determined that there is a blockage.

### **FLAVOR GRID**

The flavor grid should be cleaned regularly as it has grease and other debris falling directly on to it. Keeping it clean will greatly reduce flare-ups and grease fires.

### **TO CLEAN**

1. Wait until the entire grill is cool then remove the cooking grids.
2. Lift out the flavor grid and brush it with a steel wire brush until all the carbon build up and other debris are removed.  
It is not necessary to clean the flavor grid with soap and water.

### **TO REPLACE THE BURNERS**

Replace a burner by sliding the end with air shutter over the brass orifice. Then place the burner onto the mounting bracket and replace the screw. The burners have an offset hole for mounting to the rear bracket, which will allow the burner to be installed with the crossover holes facing up. Once reinstalled, light all of the burners and check for proper flame. (See page 12 Figure 3) Warning: Serious injury may occur if the orifice is not located properly in the burner.

## TROUBLESHOOTING

**If your ProFire gas grill does not function properly, use the following checklist before contacting your dealer for service. You may save the cost of a service call.**

PROBLEM	WHAT TO CHECK FOR AND DO
<p>Grill won't light when the rotary igniter is turned</p>	<p>With the gas turned off remove the grills and flavor grid, turn the igniter knob clockwise and look at an angle into the collector box. You can use a small mirror for this if needed. You should see a spark jump from tip of the igniter. If there is a spark, check the gas supply. Is the tank full? Is the line purged of air? Can you light the burner with a match? Check air shutter adjustment, close as needed. (See page 12.) Do other burners on the unit light? Check the orifice for blockage. (See page 12.) Is the igniter tip clean and free from debris? Sand area lightly</p>
<p>Burner flame is yellow or orange and there is a smell of gas.</p>	<p>Check the burner inlet for obstructions. (See pages 12,20.) Check the air shutter for proper adjustment. (See page 12.)</p>
<p>Low heat with control knob set on "HIGH".</p>	<p>Is the fuel hose bent or kinked? Is there an adequate gas supply? If there is only one burner that appears low, does the orifice or burner need cleaning? (See pages 20.) Are any other gas appliances at the location below normal rate? Is the air shutter too far open or closed? Is the gas supply or gas pressure low? Has the grill been preheated for at least 5 minutes?</p>
<p>The smell of gas with burner flames appearing yellow.</p> <p>The gas grill does not reach temperature.</p> <p>The gas grill heats unevenly.</p> <p>The burners make popping noises.</p>	<p>Check for spiders or insects. Spiders and insects can nest in the burner of this or any grill, and cause a disruption in the flow of gas from the burner. This is dangerous and can cause a fire behind the valve panel, damaging the grill and making it unsafe to operate. You should inspect the burners at least once a year or immediately if any of these conditions occur or persist.</p> <p>Check air shutter adjustment. (See page 12.) Check burners for clogged ports. (See page 20.)</p>

## Professional and Deluxe Series Warranty

ProFire, LLC hereby warrants to the Original Purchaser of the ProFire Gas Grill that it will be free of defects in material and workmanship from the date of purchase as follows:

***Grill must be registered within 60 days of the date of purchase with ProFire for warranty to be valid.***

### **LIMITED LIFETIMED**

**Stainless Steel Body • Stainless Steel Hoods & Liners • Stainless Steel Lids • Stainless Steel Carts & Shelves • Stainless Steel Heat Plates • Stainless Steel Briquette Grate • Porcelain Briquettes • Stainless Steel Drip Pans • Stainless Steel Burners • Cooking Grids • Warming Racks • Gas Manifold • Gas Valves**  
(against rust through)

### **5-YEAR WARRANTY**

Infrared Burners

### **2-YEAR**

Cast Iron Side Burners • Lights & Electronics • All Remaining Parts  
(against rust through)

When assembled and operated in accordance with the printed instructions accompanying it. ProFire requires reasonable proof of your date of purchase. *Therefore, you must retain your sales slip or invoice and register your grill with ProFire. This warranty is in effect for all grills purchased after April 1st, 2018.*

***Grills in a commercial, community or multi-tenant application will have a 1-year warranty on all parts.***

This Limited Warranty shall be limited to the repair or replacement of parts, which prove defective under normal use and service and which on examination, shall indicate, to ProFire's satisfaction, they are defective. Warranty is for parts only. There is no warranty for labor. Before returning any parts, contact the ProFire Customer Service Department. If ProFire confirms the defect and approves the claim, ProFire will elect to replace such parts without charge. If you are required to return defective parts, transportation charges must be prepaid. ProFire will return parts to the purchaser, freight or postage prepaid.

This Limited Warranty does not cover failures or operating difficulties due to accident, abuse, misuse, alteration, misapplication, vandalism, improper installation or improper maintenance or service, or failure to perform normal and routine maintenance, including but not limited to damage caused by insects within the burner tubes, as set out in the owner's manual.

Discoloration due to exposure of chemicals either directly or in the atmosphere such as chlorine, fertilizers, lawn pesticides, and salt can affect the Stainless Steel components and for this reason does not fall under the warranty terms. Deterioration or damage due to severe weather conditions such as hail, excessive humidity, hurricanes, earthquakes, tornadoes, or other acts of God are not covered by this Limited Warranty. ***Discoloration of Stainless Steel including but not exclusive to surface rust is normal and is not covered by this Warranty. Therefore the discoloration, surface rust or rust are not covered unless there is a loss of structural integrity or rust through.***

There are no other express warrants except as set forth herein and any applicable implied warranties of merchantability and fitness are limited in duration to the period of coverage of this express written Limited Warranty. ProFire is not liable for any special, indirect or consequential damages.

ProFire does not authorize any person or company to assume for it any other obligation or liability in connection with the sale, installation, use, removal, return, or replacement of its equipment; and no such representations are binding on ProFire. Implied warranty shall not extend beyond the duration of this written warranty. This warranty is in lieu of all other warranties expressed or implied and all other obligations or liability in connection with the sale of this appliance.

**INDEX**

<b>CATEGORY</b>	<b>PAGE</b>	<b>CATEGORY</b>	<b>PAGE</b>
Air shutters	11	Grill burners	18,19
Aluminum foil	3	Location requirements	8
Battery ignitors	16	LP cylinders	3-4,5-7
BTU's	5	LP gas & regulator	5-7
Burner air adjustment	11	Minimum clearances	8
Care & maintenance	18-19	Natural gas	6
Cart (storing)	4	Non-combustible construction	8
Charcoal	4	Opening the lid	2,13
Children	4	Pool chemicals	3
Cigarette smoking	10	Pot holders	4
Cleaning the burners	19	Pots and pans	4
Cleaning the flavor grid	19	Preheating	15
Cleaning the orifices	19	Preheating the grill	13
Code compliance	3,5,17	Rear broiler	14,17
Combustible construction	8	Recreational vehicles	4
Combustible surfaces	3-4	Replacing the burners	19
Commercial range top burners	16	Rotisserie	17
Cooking grids	18	Safety practices	3,4
Cutout Dimensions	9	Searing	15
Doneness chart	15	Shut off valve	5,7
Drip pan (tray)	4,18	Side burner grates	18
Drip tray	18	Side burners	14,16,19
Dual purpose thermometer	15	Smoker box	16
Flame height	11,16	Soap solution	10
Flare ups	15	Stainless steel	18
Flavor grid	3,19	Temperature	15
Gas requirements	5-7	Total gas consumption	5
Gas supply	5,6,7	Troubleshooting	20
Gasoline	4	Using the ProFire	15
Grease	4	Utensils	3
Grill & side burners maintenance	18	Ventilation	4
Installation check list	12	Ventilation hoods	8
Insulated sleeve	8,9	Windy conditions	4,14
Joint sealant	6	Wood chips	16
Leak testing	10		
Lighting the burners	4,13-14		

# Modern Home Products Corporation

One Quality MHP Product Leads To Another



Stainless Steel Gas Grills and Accessories for Built-in Outdoor Kitchens



Cast Aluminum Infrared Gas Grills



Portable Gas Grills



Infrared Indoor Gas Grill



Gas and Electric Outdoor Lighting Post and Pedestal Mountings



Stainless Steel Portable Gas Grills



Gas Slow Cookers

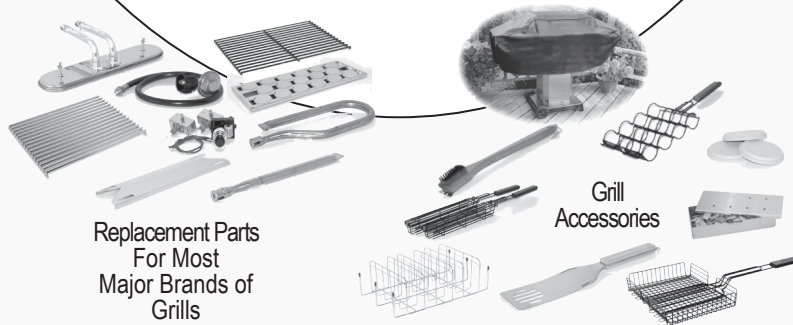

Replacement Parts For Most Major Brands of Grills

Grill Accessories



Gas Fired Luau Torches

MHP is a family owned and operated company based in Antioch, Illinois. Known for the invention of the "World's First Outdoor Gas Grill" in 1960. Our cast aluminum and stainless steel grills are made right here in the USA. Being the first in gas grills carries a certain responsibility. We are committed to upholding our reputation in the marketplace for the best quality products and service to our customers. Since 1958 we've combined the best materials for outdoor use along with manufacturing process, and product performance that is unmatched by anyone.

**ProFire® Grills**  
Perfection by Design  
A Division of Modern Home Products Corp.

5565 North 124th Street • Butler, Wisconsin 53007  
Phone: 262.781.4657 • 888.761.4657  
Fax: 262.781.3965 • 888.781.3965  
Email: [info@profiregrills.com](mailto:info@profiregrills.com)  
Web Site: [www.profiregrills.com](http://www.profiregrills.com)

**Modern Home Products Corporation**

**MHP**  
OUTDOOR GRILLS

**ProFire® Grills**  
Perfection by Design

**PHOENIX**  
GRILLS

**BRAVO**

**MHP**  
GRILL PARTS

*Everglow*  
GAS LAMP & TORCHES

Celebrating 60 Years in Business