

This Owner's Manual is provided and hosted by [Appliance Factory Parts](#).



Monessen Hearth VWF24NM Owner's Manual

[Shop genuine replacement parts for Monessen Hearth
VWF24NM](#)



[Find Your Monessen Hearth Fireplace Parts - Select From 701 Models](#)

----- Manual continues below part list -----

Available Replacement Parts for Monessen Hearth VWF24NM

[24D0305](#)

REGULATOR-NG 4.0+

MHS, Inc.

VENTED GAS LOG SET INSTALLATION AND OPERATING INSTRUCTIONS

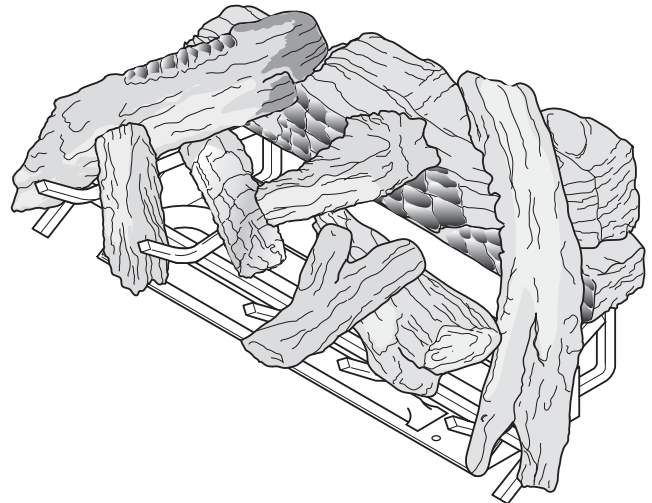

MODELS: VWF18 VWF24 VWF30 VWF36
Natural Gas or Propane/LPG Control Type:
Manual and Milli-Volt



Approved to ANSI Z21.60

This gas log set is to be installed only in a solid-fuel burning fireplace with a working flue constructed of noncombustible material.

WARNINGS

IF THE INFORMATION IN THIS MANUAL IS NOT FOLLOWED EXACTLY, A FIRE OR EXPLOSION MAY RESULT CAUSING PROPERTY DAMAGE, PERSONAL INJURY OR LOSS OF LIFE.

- Do not store or use gasoline or other flammable vapors and liquids in the vicinity of this or any other appliance.
- **WHAT TO DO IF YOU SMELL GAS**
 - Do not try to light any appliance.
 - Do not touch any electrical switch; do not use any phone in your building.
 - Immediately call your gas supplier from a neighbor's phone. Follow the gas supplier's instructions.
 - If you cannot reach your gas supplier, call the fire department.
- Installation and service must be performed by a qualified installer, service agency or the gas supplier.

READ AND SAVE THESE INSTRUCTIONS

CONTENTS

Important Safety Information	3	Operating Instructions	42
Product Specifications	4	Manual Control Lighting Instructions	42
Getting Started	5	Milli-Volt Control Lighting Instructions	43
Placement in a Fireplace with a Restrictive Barrier	6	Flame Appearance	44
Installation	7	Fireplace Draft Test	45
Damper Stop Installation.....	7	Remote Control Receiver Replacement	46
Before Installing the Appliance.....	7	Cleaning and Servicing	46
Installing Valve Cover.....	8	Replacement Parts Lists	47
Wiring (Milli-volt)	9	Assembly.....	47
Connecting the Gas	10	Massive Oak Logs.....	48
Manual Control.....	11	American Oak Logs.....	49
Milli-Volt Control	11	Birch Logs	49
Log Placement	12	Split River Oak Logs	50
VWF18 Massive Oak Log Placement	12	Split Pine Logs	51
VWF24 Massive Oak Log Placement	14	Weathered Pine Logs.....	52
VWF30 Massive Oak Log Placement	15	Massachussetts Residents Only	53
VWF36 Massive Oak Log Placement	17	Warranty	Back Cover
VWF18 American Oak Log Placement.....	19		
VWF24 American Oak Log Placement.....	20		
VWF30 American Oak Log Placement.....	21		
VWF24B Log Placement.....	23		
VWF24/18 Split River Oak Log Placement ..	24		
VWF30/24 Split River Oak Log Placement ..	26		
VWF36/30 Split River Oak Log Placement ..	28		
VWF18 Split Pine Placement.....	30		
VWF24 Split Pine Placement	32		
VWF30 Split Pine Placement	32		
VWF24/18WP Weathered Pine Log Placement	36		
VWF30/24WP Weathered Pine Log Placement	38		
WF36/30WP Weathered PINE LOG	40		

IMPORTANT SAFETY INFORMATION

INSTALLER

Please leave these instructions with the appliance.

OWNER

Please retain these instructions for future reference.

IMPORTANT

Read these instructions carefully before installing or trying to operate this gas log set.

WARNING

- Any change to this appliance or its controls can be dangerous.
- Improper installation or use of the heater can cause serious injury or death from fire, burns, explosion or carbon monoxide poisoning.
- Do not allow fans to blow directly into the fireplace. Avoid any drafts that alter burner flame patterns.
- Do not use a blower insert, heat exchanger insert or other accessory, not approved for use with this appliance where applicable.

1. The installation, combustion and ventilation air must conform with local codes or, in the absence of local codes, with the National Fuel Gas Code, ANSI Z223.1, or the CAN/CGA-B149 Installation code (series). This unit complies with ANSI Z21.60 decorative gas appliance for installation in solid-fuel burning fireplace.
2. Installation and repair should be done by a qualified service person. MHS Vented Gas Logs must be installed only in a masonry or a UL 127 solid-fuel fireplace with minimum venting requirements, see installation section.
3. To prevent malfunction, gas log set and flue should be cleaned at least annually by a professional service person. More frequent cleaning may be required due to excessive lint from carpeting, etc. It is imperative that control compartments, burners and circulating air passageways be kept clean.
4. **A damper clamp must be installed to provide the minimum permanent vent opening to vent flue products, Refer to installation instructions.**
5. Never burn solid fuels in a fireplace where a gas log set is installed.
6. ***This appliance must NOT be used with glass doors in the closed position.*** A fireplace screen must be in place when the log set is burning. Provisions for adequate combustion air must be provided. Adequate combustion air usually results in all flames curling into the fireplace away from the screen and up the flue.
8. Keep room area clear and free from combustible materials, gasoline and other flammable vapors and liquids.
9. Children and adults should be alerted to the hazard of high surface temperature and should stay away to avoid burns or clothing ignition.
10. Young children should be carefully supervised when they are in the same room with the gas log set in operation.
11. Do not place clothing or other flammable material near the fireplace when the gas logs are in use.
12. Do not use this gas log set if any part has been underwater. Immediately call a qualified service technician to inspect the gas logs and replace any part of the control system and any gas control which has been under water.
13. The gas log set must be isolated from the gas supply piping system by closing its individual manual shutoff valve during any pressure testing of the gas supply piping system at test pressures equal to or less than 1/2 psig (3.5kPa).
14. Secure gas log set to fireplace.
15. This log set will burn off the paint on the front grate bar.
Note: See cleaning section for refurbishing.
16. **FOR MASSACHUSETTS RESIDENTS ONLY:**

WARNING

This product must be installed by a licensed plumber or gas fitter when installed within the Commonwealth of Massachusetts.

Installation of this vented gas log in the Commonwealth of Massachusetts requires the damper be permanently removed or welded in the full open position. In addition, a naturally vented gas log may not be installed in a bedroom or bathroom in the Commonwealth of Massachusetts. Flex line installation must not exceed 36".

WARNING

This appliance is for installation only in a solid fuel burning fireplace (masonry fireplace or manufactured fireplace).

SAFETY INFORMATION



www.nficertified.org

We suggest that our gas hearth products be installed and serviced by professionals who are certified in the U.S. by the National Fireplace Institute® (NFI) as Gas Specialists.

WARNING

Never connect unit to private (non-utility) gas wells. This gas is commonly known as wellhead gas.

PRODUCT SPECIFICATIONS

MINIMUM HEARTH DIMENSIONS

MANUAL CONTROL

Model	A	B	C
VWF18	21"	13 ¹ / ₂ "	24"
VWF24	27"	13 ¹ / ₂ "	30"
VWF30	33"	13 ¹ / ₂ "	36"
VWF36	39"	13 ¹ / ₂ "	42"

MILLI-VOLT CONTROL*

Model	A	B	C
VWF18	25"	13 ¹ / ₂ "	28"
VWF24	31"	13 ¹ / ₂ "	34"
VWF30	37"	13 ¹ / ₂ "	40"
VWF36	43"	13 ¹ / ₂ "	46"

***NOTE: Use the above chart for SRO and WP Manual Control Logs.**

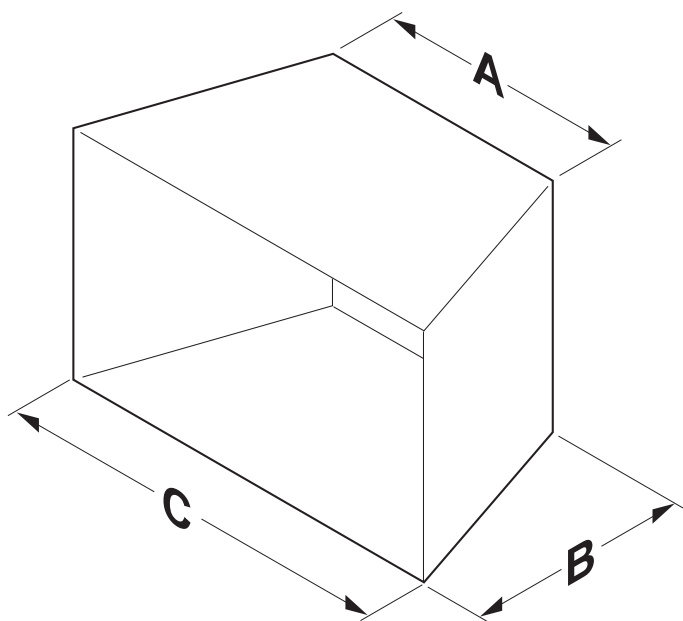

Figure 1 - Minimum Hearth Dimensions

The manifold pressure for propane is 10" WC.

The manifold pressure for natural is 4"WC.

The minimum inlet gas supply pressure is 4" WC for natural and 10" WC for LP.

The maximum inlet gas supply pressure for this log set is 10" WC for natural and 13" WC for LP.

Nominal Rates (BTU/Hr)

VWF18N/P	60,000	VWF24N	70,000	VWF30N	80,000	VWF36N	80,000
		VWF24P	60,000	VWF30P	60,000	VWF36P	60,000

Note: Actual performance, flame height, BTU/Hr will vary with specific installation, gas pressure, shutoff valve position (fully open), valve type, and firebox draft conditions.

MAKE SURE YOU HAVE RECEIVED ALL PARTS:

Check your packing list to verify that all listed parts have been received. You should have the following:

BURNER - GRATE ASSEMBLY 18, 24, 30, 36"

- Burner and Grate Weldment Assembly
- Lava Rocks (x2)
- Extenders with Knob (Manual Control Only)
- Glowing Embers (Rock Wool)
- Damper Clamp
- Vermiculite
- Installation /Operating Instructions
- 3/8" Aluminum tube with 3/8" 90° elbow, 1/2" to 3/8" tube fitting
- Control Cover
- Shield Plate

18", 24", 30" OR 36" CERAMIC FIBER OR REFRACTORY LOGS

- Individual Logs
- Installation Instructions

CAUTION

- Handle the gas log burner assembly by the grate only. Do not pick the unit up by the burner. Burner pan is a separate assembly.
- Gloves are recommended when handling ceramic fiber logs to prevent skin irritation from loose fibers. Logs are fragile — handle with care.

Carefully inspect the contents for shipping damage. If any parts are missing or damaged, immediately inform the dealer from whom you purchased the appliance. **Do not attempt to install any part of the appliance unless you have all parts in good condition.**

ITEMS REQUIRED FOR INSTALLATION

Ensure that the following items are available before proceeding with installation:

- External regulator (for propane/L.P.G. only)
- Shutoff valve
- Piping which complies with local codes
- Pipe wrench
- Pipe sealant approved for use with propane/L.P.G. (Resistant to sulfur compounds)
- Drill with masonry bit (for mounting to the floor)

MINIMUM OPENING AREA OF CHIMNEY DAMPER FOR VENTING

WARNING

The fireplace and gas logs function as a system. If the fireplace is not drafting properly and spilling into the room (check with a match or a smoke stick), reposition the damper clamp until a positive draft is obtained by opening the damper. If negative pressure in home prevents having a positive draft, contact your dealer for assistance.

MINIMUM CHIMNEY HEIGHT AND FLUE OPENING

CHIMNEY HEIGHT	FLUE OPENING
6'	64 sq in
8'	64 sq in
10'	64 sq in
15'	51 sq in
20'	51 sq in
30'	51sq in

PLACEMENT IN A FIREPLACE WITH A RESTRICTIVE BARRIER

IMPORTANT INFORMATION FOR THE INSTALLATION OF THIS GAS LOG SET

The following are guidelines for placing a VWF log set in a fireplace that has a restrictive barrier along the bottom front opening of the fireplace. Some examples of barriers are glass/screen door frames and sunken/recessed fireplaces.

Height of Restriction (X)	Minimum Depth of Fireplace/Firebox
No restriction	13" Manual Control 13 1/2" Milli-Volt Control
0 to 1.5"	15"
Greater than 1 1/2" to 3"	15"
Greater than 3"	ANY BARRIER GREATER THAN THREE INCHES (3") PLACED IN FRONT OF THE GAS LOG SET IS NOT RECOMMENDED BY THE MANUFACTURER.

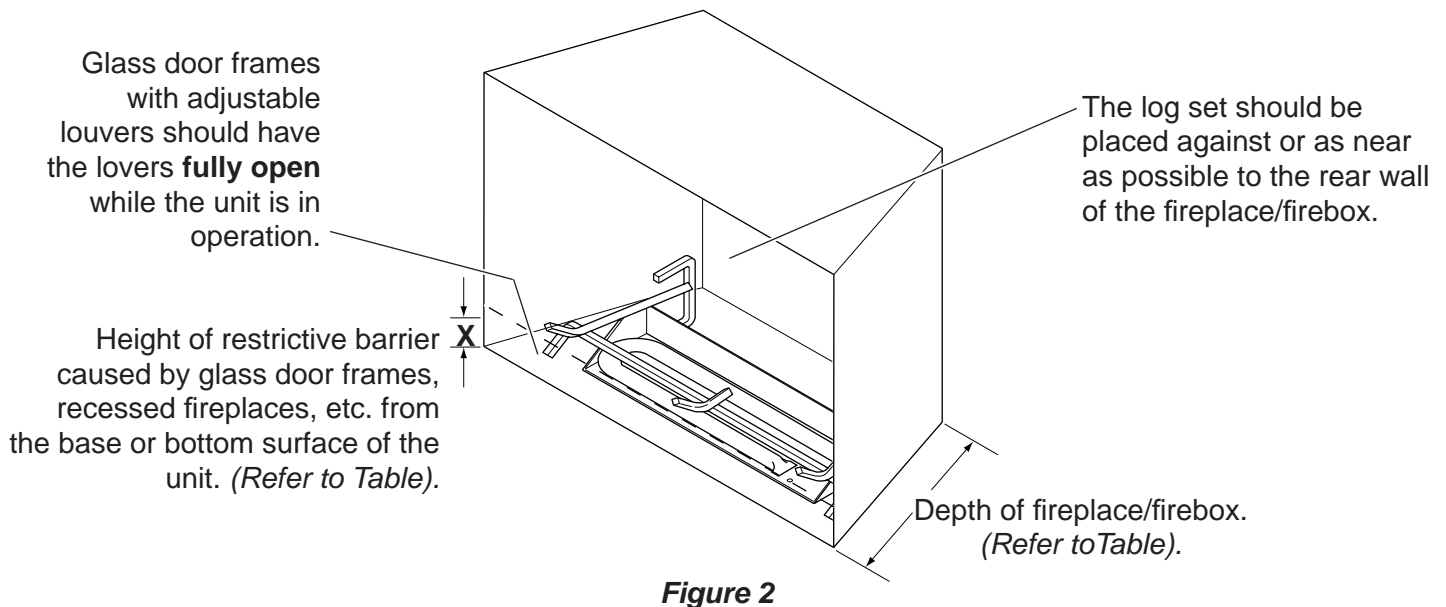

WARNING

Barriers such as the bottom of a glass door frame placed in front of a gas log set can change the air flow characteristics of the fireplace which in turn can cause the unit to overheat and malfunction. Any deviation from the installation guidelines on this sheet will potentially void the warranty.

NOTE: Non combustible material such as refractory brick may be used to line the floor of the fireplace in order to raise the height of the gas log set in relation to a restrictive barrier.

CAUTION

If the fireplace has a restrictive barrier and is equipped with a remote receiver, it must be placed outside or the combustion chamber. See "Installing Receiver" on page 9.

INSTALL AND OPERATE THE APPLIANCE AS DIRECTED IN THIS MANUAL.

DAMPER STOP INSTALLATION

A damper stop must be provided with the unit. The damper stop must be installed as shown in (Figure 3) to prevent full closure of the fireplace damper blade and provide a minimum flue opening, per table on page 5.

Should the clamp not fit, or provide the required permanent opening from the table, have the damper cut to provide a minimum permanent opening or install a permanent stop.

FOR MASSACHUSETTS RESIDENTS ONLY

Installation of this vented gas log set in the Commonwealth of Massachusetts requires the damper be permanently removed or welded in the fully open position. In addition, a naturally vented gas log may not be installed in a bedroom or bathroom in the Commonwealth of Massachusetts.

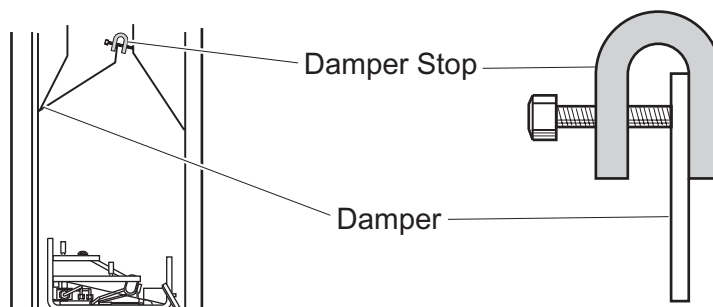

Figure 3 - Damper Stop Installation

In compliance with ANSI Z21.60•CGA2.26 and National Fuel Gas Code, Section 6.

BEFORE INSTALLING THE APPLIANCE:

- Turn off gas supply to fireplace or firebox.
- Clean the fireplace floor and chimney before installing the log set. Seal any ash clean-out doors to protect the unit from down drafts.

ASSEMBLY PROCEDURE

1. Place grate/burner assembly into firebox with the front pan facing forward.
2. Drill two (2) $\frac{5}{32}$ " diameter holes approximately $1\frac{1}{2}$ " deep.
3. Anchor the front pan to the floor using the screws provided.

Proper installation of the grate is essential to prevent any movement of the gas logs and controls during operation.

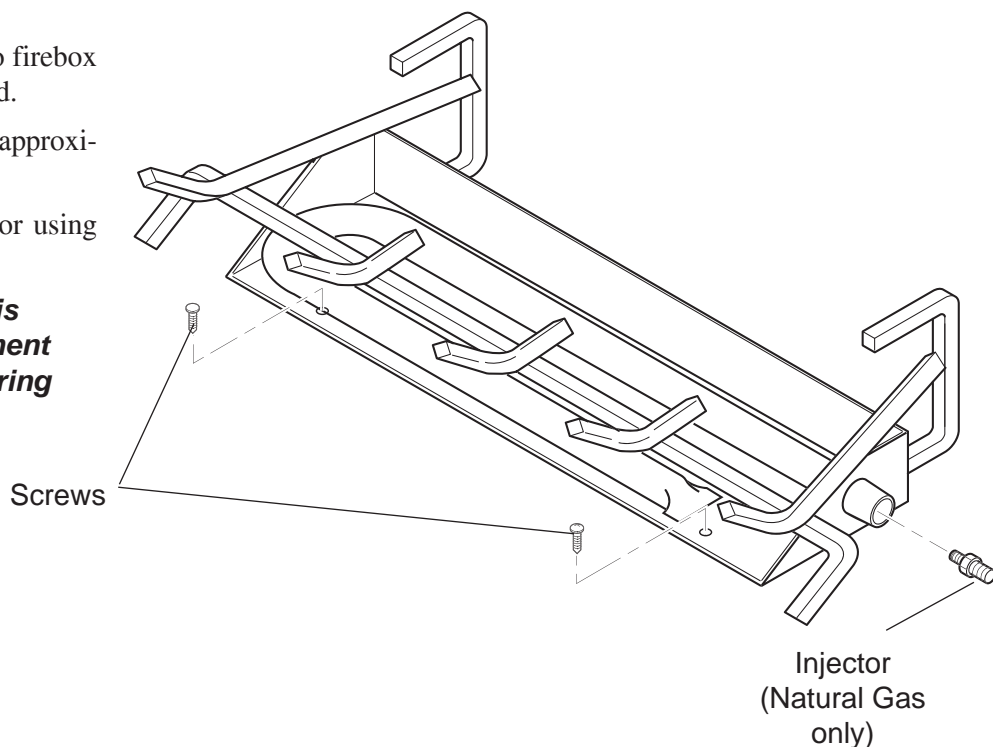

Figure 4 - Securing Grate/Burner Assembly into Firebox

INSTALLATION

INSTALLING VALVE COVER

WARNING

Covers must be installed prior to operation to prevent overheating.

NOTICE

Grate bar must not touch the valve.

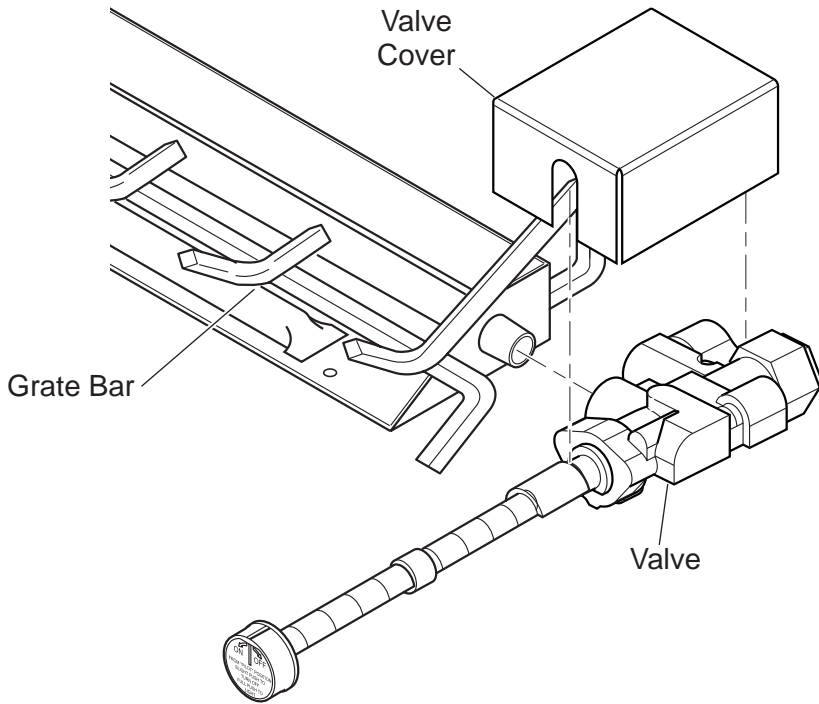

Figure 5 - Placing Cover on Manual Control

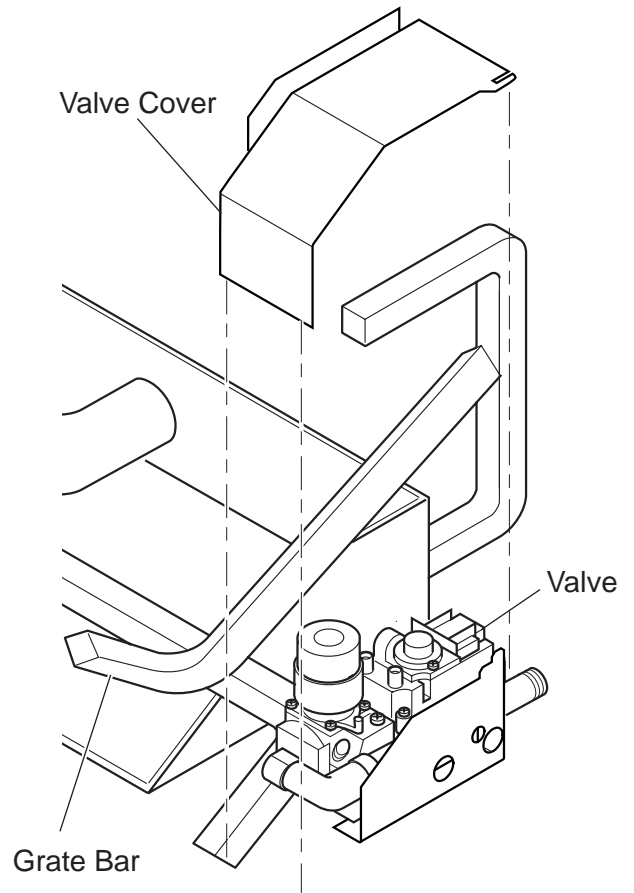

Figure 6 - Placing Cover on Milli-volt Control

WARNING Label all wires prior to disconnection when servicing controls. Wiring errors can cause improper and dangerous operation. Verify proper operation after servicing.

WARNING Do not connect to 110 volt supply.

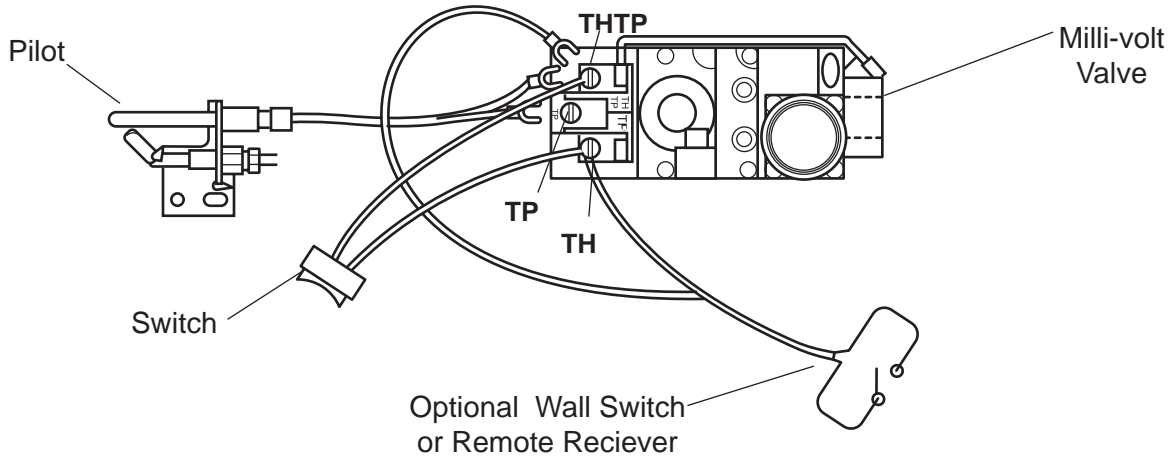

Figure 7 - Wiring Diagram

The Milli-Volt (thermopile) is a self powered combination gas control that does not require 110VAC to operate. Refer to *Figure 8* and installation instructions provided with optional wall switch or remote control for wiring instructions. A maximum length of 15 feet of 18awg two conductor wire is to be used for wall switch. Note switches must be suitable for millivolt operation. The optional wall switch must be mounted outside the firebox. The remote receiver location must not exceed a temperature of 120° F.

WARNING Keep wiring away from heat source and hot surfaces.

CHECKING SYSTEM OPERATION

The milli-volt system and individual components may be checked with a millivolt meter having a 0-1000MV range. Conduct each check shown in chart below by connection meter test leads to terminals as indicated.

CHECK TEST	TO TEST	CONNECT METER LEADS TO TERMINALS	METER READING SHOULD BE
A	COMPLETE SYSTEM	TH & THTP	Min. 100 mV
B	THERMOPILE OUTPUT	TP & THTP	Min. 325 mV

A. COMPLETE MILLI-VOLT SYSTEM CHECK

("A" READING - CONTACTS CLOSED - CONTROL KNOB "ON" - MAIN BURNER SHOULD BE COME ON)

- a. If the reading is more than 100 millivolts and the automatic valve still does not come on - replace the control.
- b. If the closed circuit reading ("A" reading) is less than 100 millivolts, determine cause for low reading — proceed as follows:

B. THERMOPILE OUTPUT READING CHECK

("B" READING - CONTACTS OPEN - MAIN BURNER OFF)

- a. 325 millivolts minimum. If the minimum millivolt reading is not obtainable, readjust pilot for maximum millivolt output. If millivolt reading is still below minimum specified, replace thermopile.

CONNECTING THE GAS

NOTICE

NOTICE: A qualified gas appliance installer must connect the appliance to the gas supply. Consult all local codes before installation.

CAUTION

Use new black iron pipe, steel pipe, copper tubing, or internally tinned copper tubing. Copper or internally tinned copper tubing can only be used according to the National Fuel Gas Code, section 2.6.3, providing gas meets sulfide limits, and where permitted by local codes. Gas piping system must be sized to provide minimum inlet pressure at the maximum flow rate (BTU/Hr). Undue pressure loss will occur if the pipe is too small.

A manual shutoff valve must be installed upstream of the appliance. Union tee and plugged 1/8" NPT pressure tapping point should be installed upstream of the appliance. See *Figure 9*.

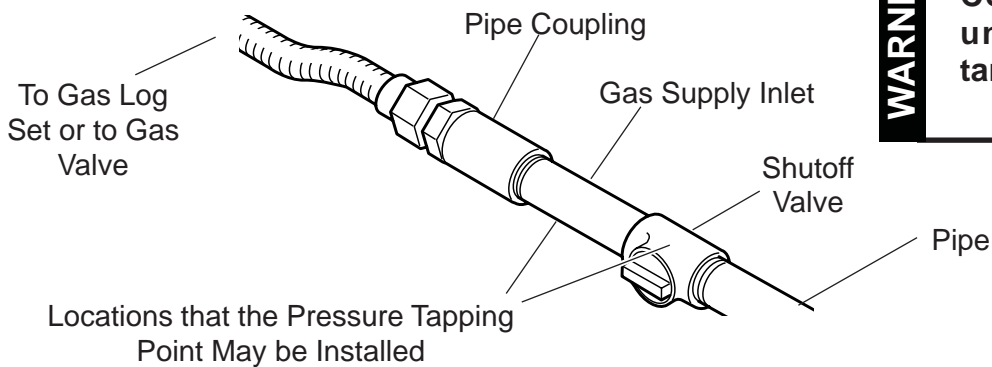

Figure 8 - Gas Connection

WARNING

Connecting directly to an unregulated propane/LPG tank can cause an explosion.

IMPORTANT: Hold appliance firmly with a wrench to prevent movement when connecting to inlet piping.

Always use an external regulator for all propane/LPG gas logs only, to reduce the supply tank pressure to a maximum of 13" w.c. High pressure natural gas systems require a regulator to reduce supply pressure to 10" W.C.

The gas log set gas inlet connection is 3/8" NPT at the regulator, inlet on the right side facing the gas log. If a left side connection is required, the connecting pipe may be led under the rear of the gas logs or behind the grate for connection to the inlet.

Test all gas joints from the gas meter to the appliance regulator for leaks using a gas analyzer or soap and water solution after completing connection. **DO NOT USE AN OPEN FLAME.**

Check the gas pressure with the appliance burning.

MANUAL CONTROL *(Figure 9)*

The pressure regulator is preset and locked to discourage tampering. If the pressure is not as specified, replace with the correct part from the parts list in this manual.

Remove 1/8" NPT plug, located on side of regulator body. Install fitting and tubing to pressure gauge. After taking pressure reading, re-install test plug, which should be checked at the pressure test point. Check for gas leaks.

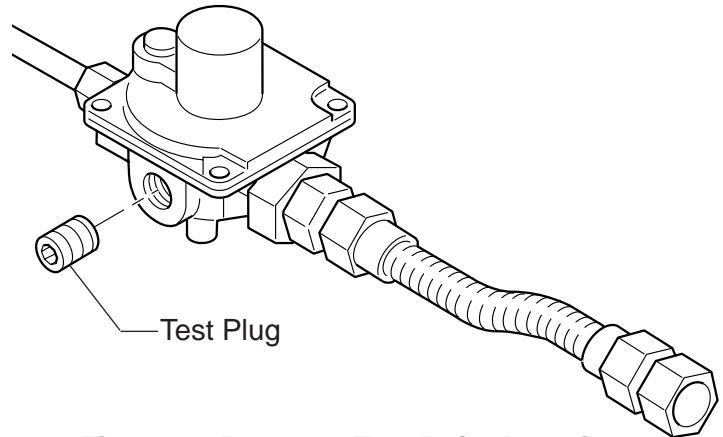

Figure 9 - Pressure Test Point Location

MILLI-VOLT CONTROL *(Figure 10)*

The valve regulator controls the burner pressure which should be checked at the pressure test point. Turn captured screw counter clockwise 2 or 3 turns and then place tubing to pressure gauge over test point (Use test port labeled "OUT"). After taking pressure reading, be sure and turn captured screw clockwise firmly to re-seal. Do not over torque. Check for gas leaks.

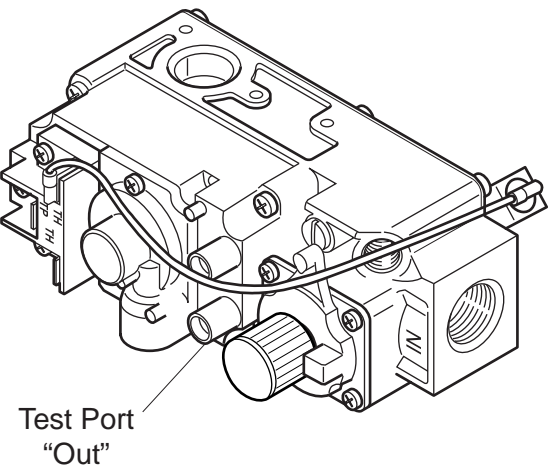

Figure 10 - Pressure Test Point Location

LOG PLACEMENT

FILLING THE BURNER PAN

Fill the burner pan with vermiculite to the bottom of the rear log and sloped to the front edge of the burner pan. Excess vermiculite can spill forward or to the side of the burner pan. Do not overfill the propane model. Do not cover the pilot (if SPK or MVVK is installed) with vermiculite or rock wool (embers).

PLACEMENT OF GLOWING EMBERS (ROCK WOOL)

The Wildfire flame appearance can vary due to differences in draft and fireplace configurations and ember placement. After installing rear (#1) and front logs (#2 and #3), cover the entire top surface of the vermiculite in the burner pan with the rock wool supplied with unit. Tear the rock wool into pieces approximately 1/2" in size (roughly the size of a nickel) and cover the burner evenly. Do not use more rock wool than the amount supplied with the unit. To enhance the appearance of the Wildfire flame, it is recommended to form a mound of rock wool in the center of the burner, 2" to 3" high, visible through the two front logs.

PLACEMENT OF DECORATIVE VOLCANIC ROCK

Sprinkle volcanic rock in front of front glowing embers and to both sides.

DO NOT SPRINKLE ON BURNERS, EMBER BED, PILOT OR LOGS.

IMPORTANT: Do not handle logs with your bare hands! Always wear gloves to prevent skin irritation from ceramic fibers. After handling logs, wash your hands gently with soap and water to remove any traces of fibers.

VWF18 MASSIVE OAK LOGS

1. Slide shield plate down back of burner pan. *See Figure 11.*
2. Center rear log #1 on grate bars and flush with rear of the grate. *See Figure 12.*

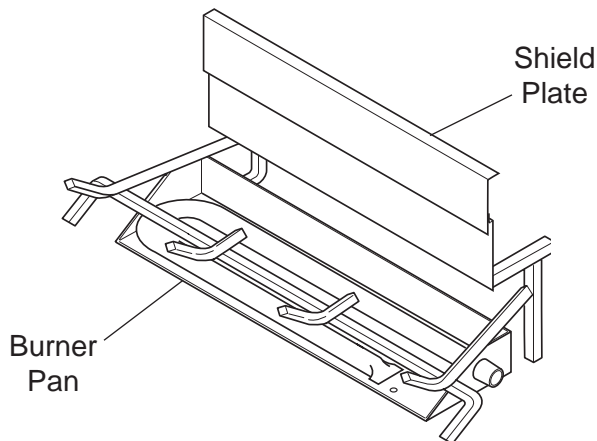

Figure 11 - Sliding Shield Plate Down Back of Burner Pan

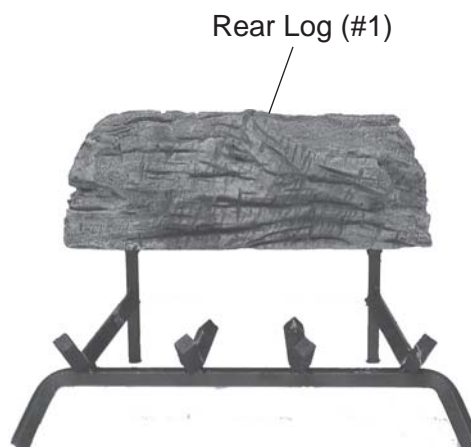

Figure 12 - Centering Rear Log (#1) on Grate Bars

Continued

LOG PLACEMENT

3. Place front left log #2 on the front of the grate and to the left. *See Figure 13.*
4. Place front right log #3 on the front of the grate and to the right. *See Figure 14.*

NOTE: Allow 2" between the back log and the two front logs.

5. Install left side middle log #4 as shown. *See Figure 15.*
6. Install right side middle log (#5). *See Figure 16.*
7. Install right top log #5 as shown. *See Figure 17.*

Front Left Log (#2)

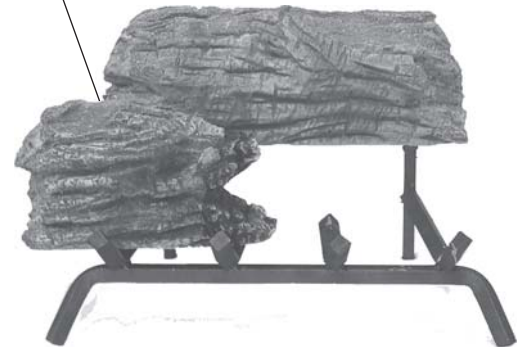

Figure 13 - Placing Front Left Log (#2) on Grate

Front Right Log (#3)



Figure 14 - Placing Front Right Log (#3)

Left Side Middle Log (#4)

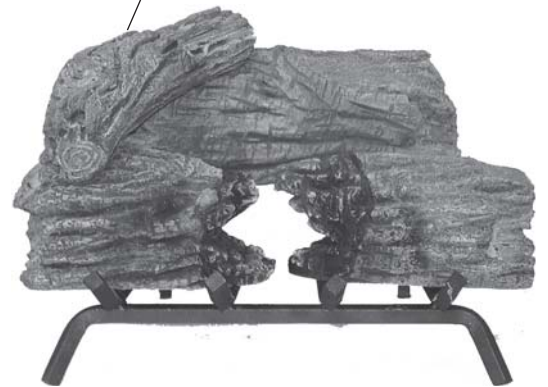

Figure 15 - Placing Left Middle Log (#4)

Right Side Middle Log (#5)

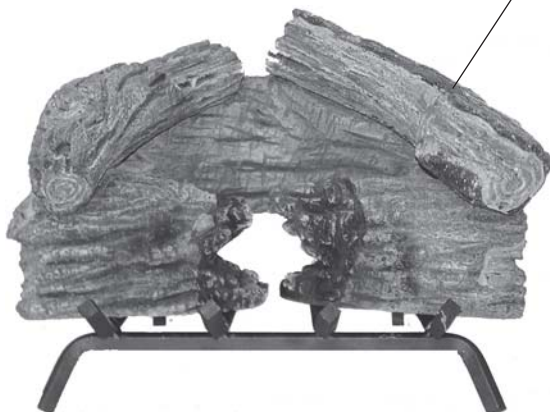

Figure 16 - Installing Right Side Middle Log (#5) and Left Top Log (#7)

Right Top Log (#6)

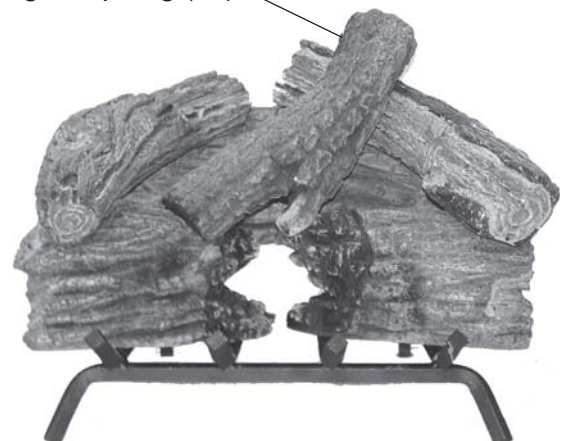

Figure 17 - Installing Right Top Log (#6)

LOG PLACEMENT

VWF24 MASSIVE OAK LOGS

1. Slide shield plate down back of burner pan. See Figure 18.
2. Center rear log #1 on grate bars and flush with rear of the grate. See Figure 19.
3. Place front left log #2 on the front of the grate and to the left. See Figure 20.
4. Place front right log #3 on the front of the grate and to the right. See Figure 21.

NOTE: Allow 2" between the back log and the two front logs.

5. Install left side middle log #4 as shown. See Figure 22.
6. Install right side middle log #5 as shown. See Figure 23.

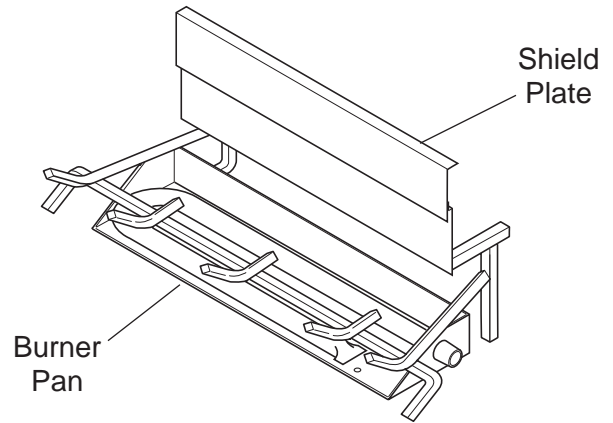

Figure 18 - Sliding Shield Plate Down Back of Burner Pan

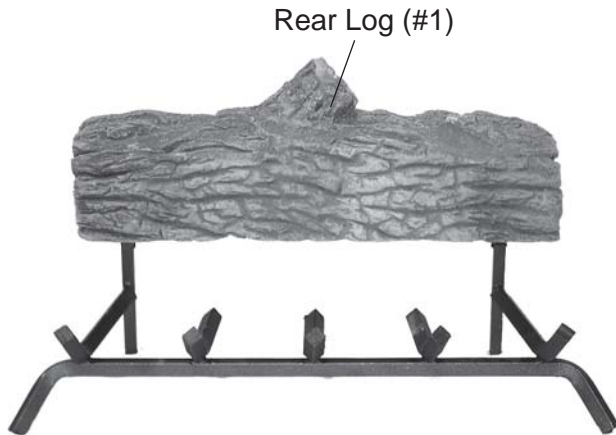

Figure 19 - Centering Rear Log (#1) on Grate Bars

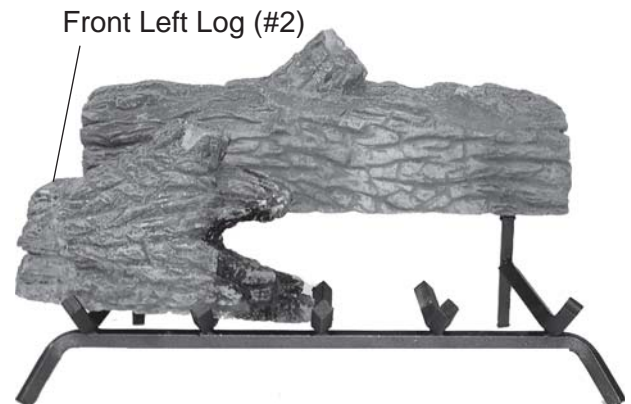

Figure 20 - Placing Front Left Log (#2) on Grate

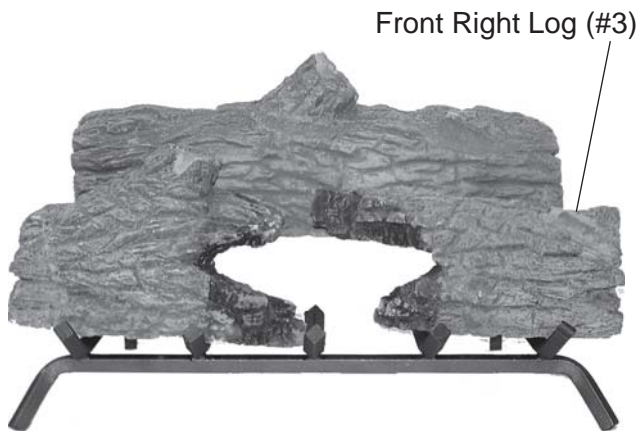

Figure 21 - Placing Front Right Log (#3)

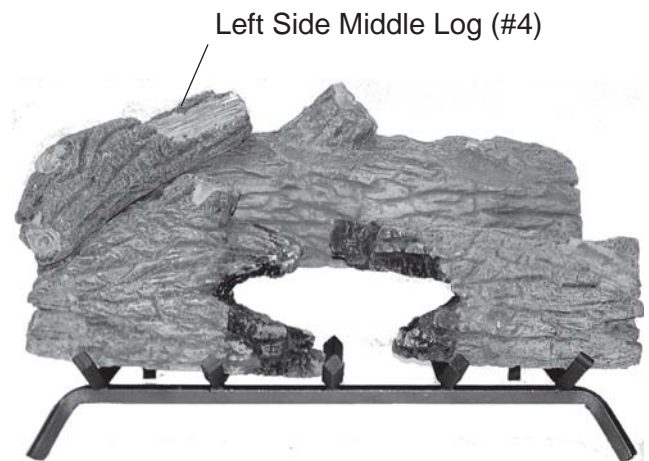

Figure 22 - Placing Left Middle Log (#4)

Continued

7. Install left top log #7 as shown. *See Figure 23.*
8. Install right top log #6 as shown. *See Figure 24.*

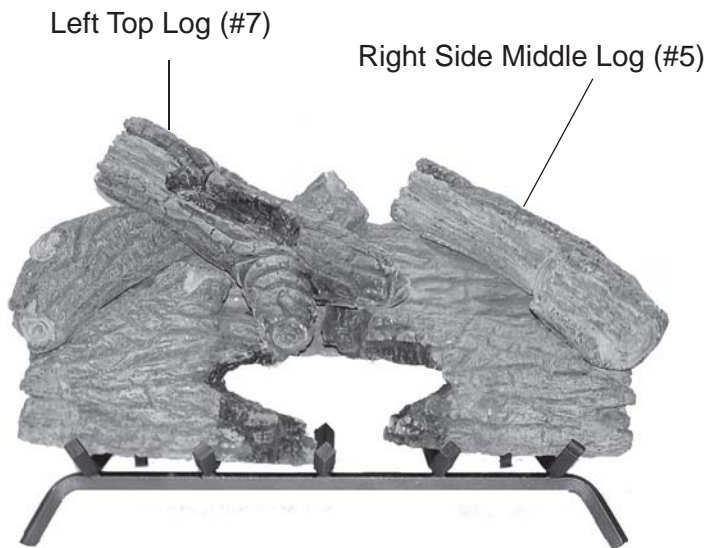

Figure 23 - Installing Right Side Middle Log (#5) and Left Top Log (#7)

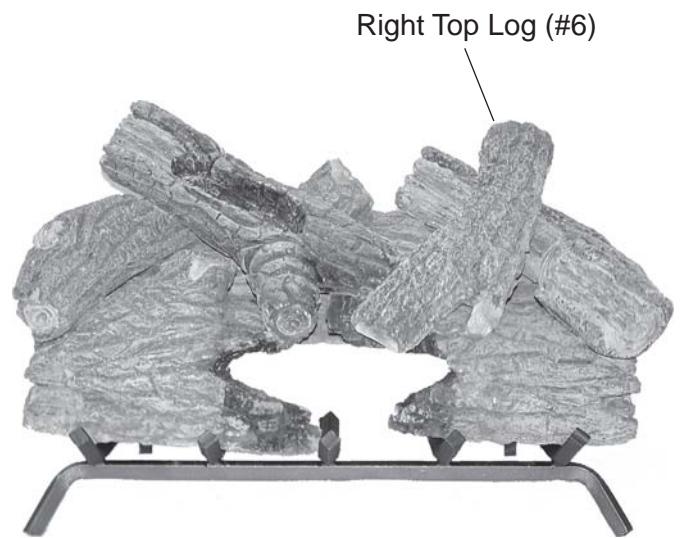

Figure 24 - Installing Right Top Log (#6)

VWF30 MASSIVE OAK LOGS

1. Slide shield plate down back of burner pan. *See Figure 25.*
2. Center rear log #1 on grate bars and flush with rear of the grate. *See Figure 26.*

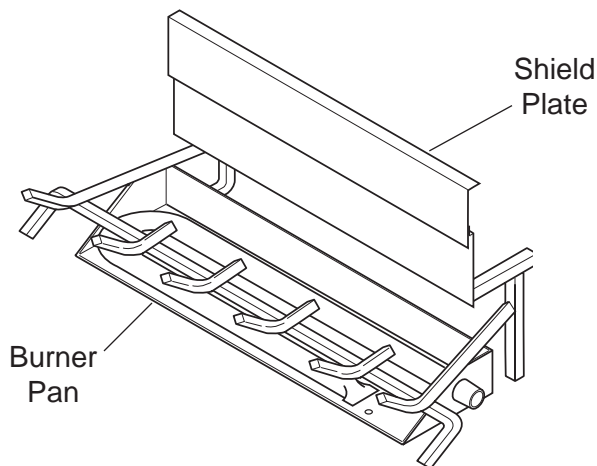

Figure 25 - Sliding Shield Plate Down Back of Burner Pan

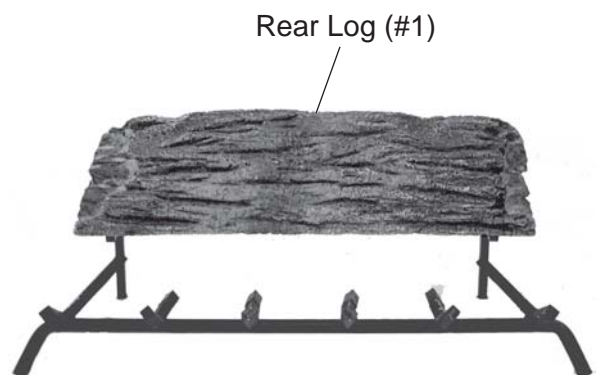

Figure 26 - Centering Rear Log (#1) on Grate Bars

Continued

LOG PLACEMENT

VWF30 MASSIVE OAK LOGS *(continued)*

3. Place front left log #2 on the front of the grate and to the left.
See Figure 27.

4. Place front right log #3 on the front of the grate and to the right.
See Figure 28.

NOTE: Allow 2" between the back log and the two front logs.

5. Install left middle log #4 as shown. *See Figure 29.*

6. Install right middle log #5 as shown. *See Figure 30.*

7. Install right top log #6 as shown. *See Figure 31.*

8. Install left top log #7 as shown. *See Figure 32.*

9. Install top crossover log #8 as shown. *See Figure 33.*

Front Left Log (#2)

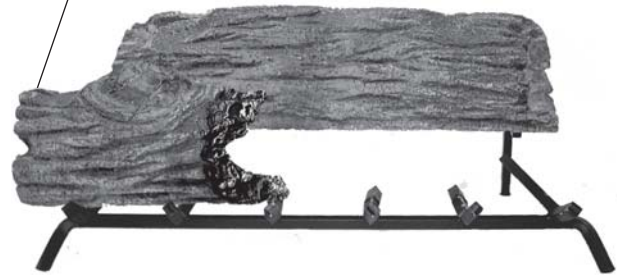

Figure 27 - Placing Front Left Log (#2) on Grate

Front Right Log (#3)

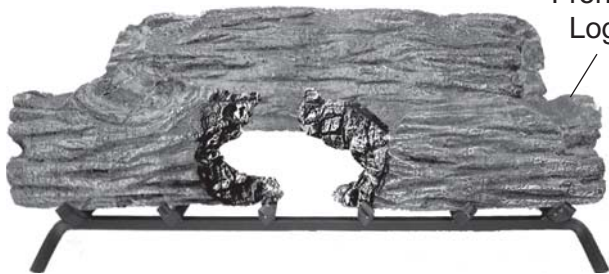

Figure 28 - Placing Front Right Log (#3)

Left Middle Log (#4)

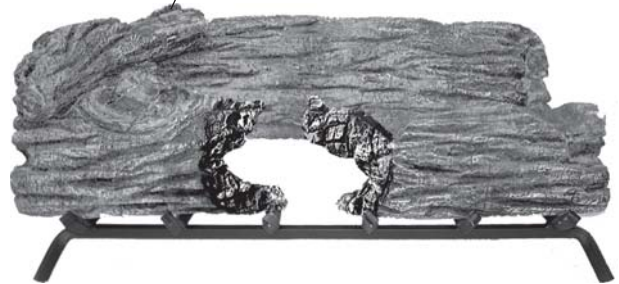

Figure 29 - Placing Left Middle Log (#4)

Right Middle Log (#5)

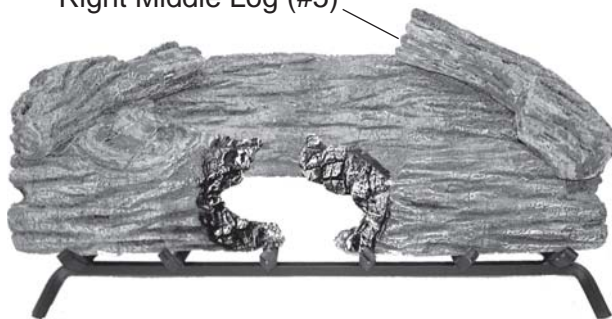

Figure 30 - Installing Right Middle Log (#5)

Right Top Log (#6)

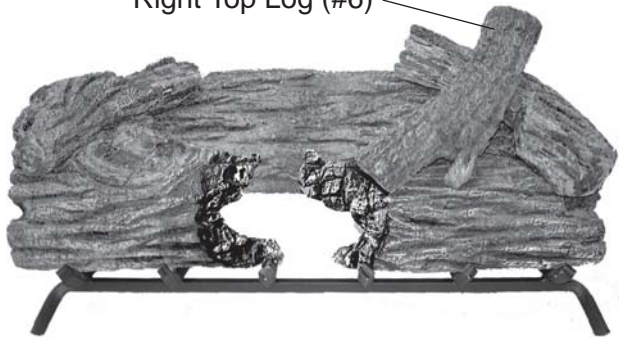

Figure 31 - Installing Right Top Log (#6)

Left Top Log (#7)

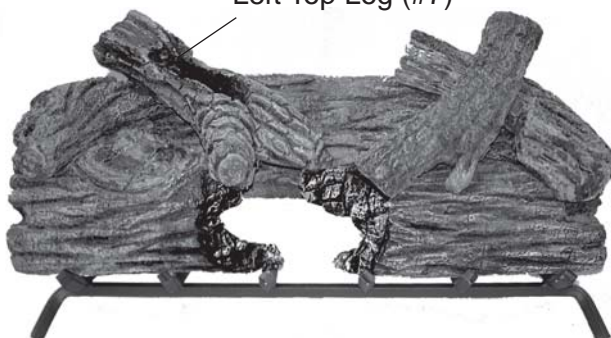

Figure 32 - Installing Left Top Log (#7)

Top Crossover Log (#8)

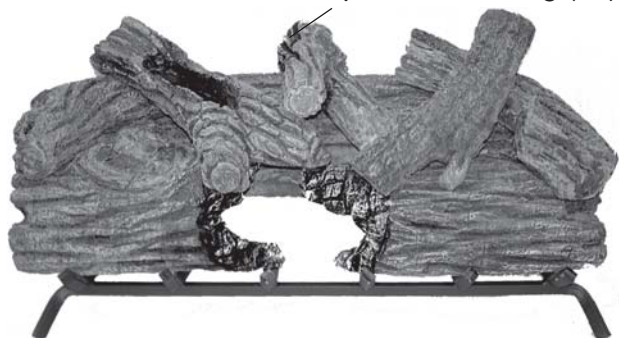

Figure 33 - Installing Top Crossover Log (#8)

VWF36 MASSIVE OAK LOGS

1. Slide shield plate down back of burner pan. *See Figure 34.*
2. Center rear log #1 on grate bars and flush with rear of the grate. *See Figure 35.*
3. Place front left log #2 in front of the plate and to the left. *See Figure 36.*
NOTE: Allow 2" between the back log and the front left log.
4. Place center front log #3 on middle grate prong. *See Figure 37.*
5. Place front right log #4 in front of the plate and to the right. *See Figure 38.*
NOTE: Allow 2" between the back log and the right front log.

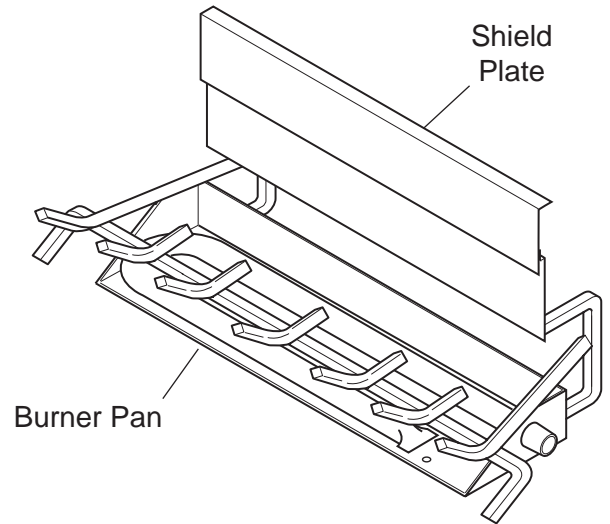

Figure 34 - Sliding Shield Plate Down Back of Burner Pan

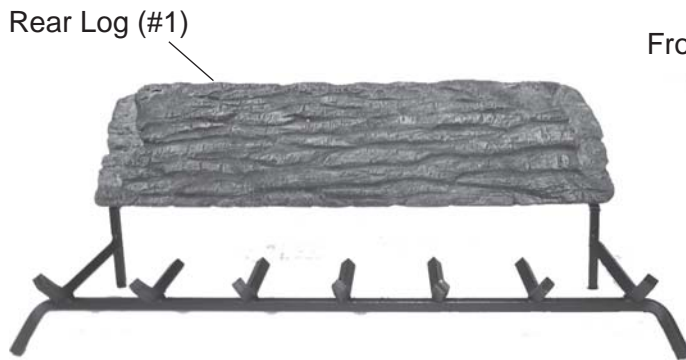

Figure 35 - Centering Rear Log (#1)

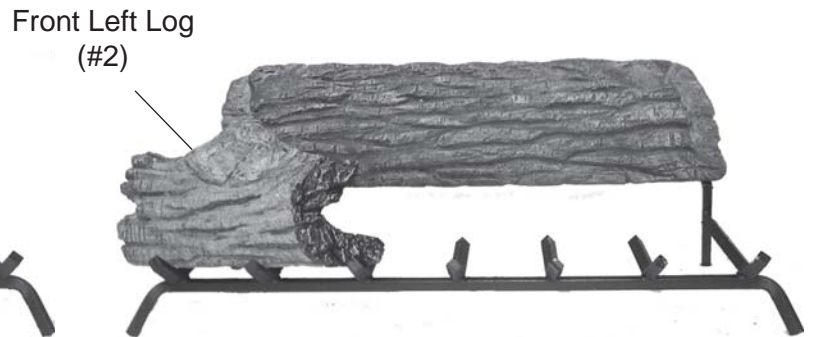

Figure 36 - Placing Front Left Log (#2)

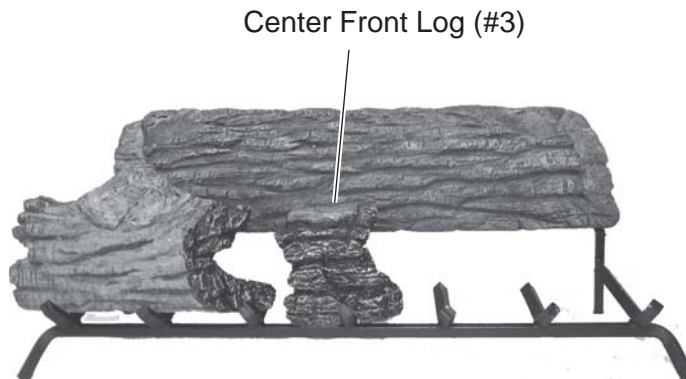

Figure 37 - Placing Center Front Log (#3)

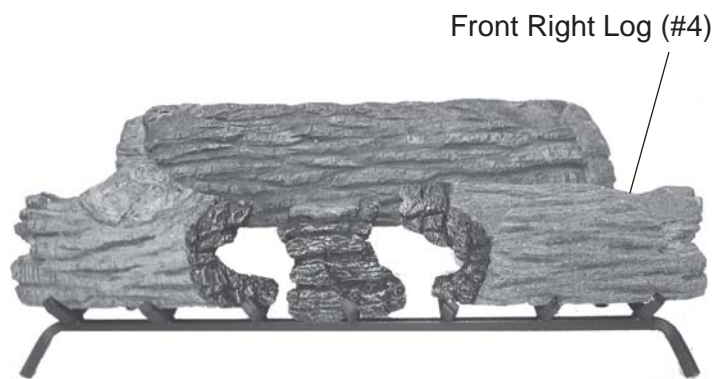

Figure 38 - Placing Right Front Log (#4)

Continued

LOG PLACEMENT

VWF36 MASSIVE OAK LOGS (continued)

6. Install left side log #6. See Figure 39.
7. Install right side middle log #7. See Figure 40.
8. Install right side log #8. See Figure 41.
9. Install top left middle log #10. See Figure 42.
10. Install top left log #9. See Figure 43.
11. Install top right log #11. See Figure 44.
12. Install top middle log #5. See Figure 45.

Right Side Middle Log (#7)

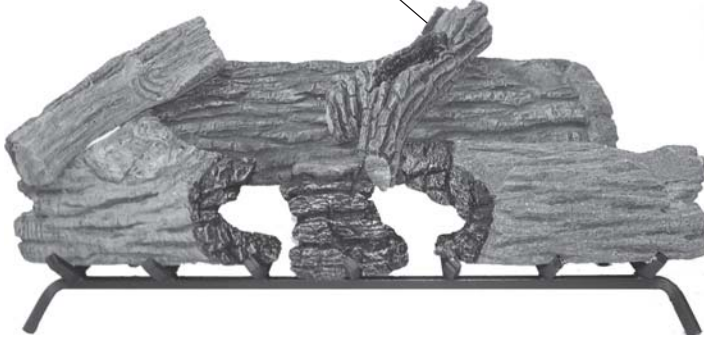

Figure 40 - Installing Right Side Middle Log (#7)

Top Left Middle Log (#10)

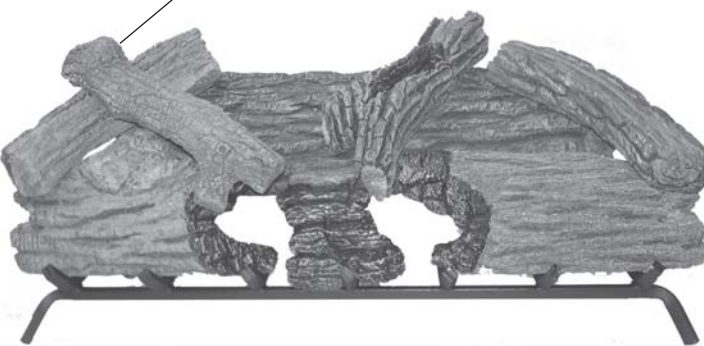

Figure 42 - Installing Top Left Middle Log (#10)

Top Right Log (#11)

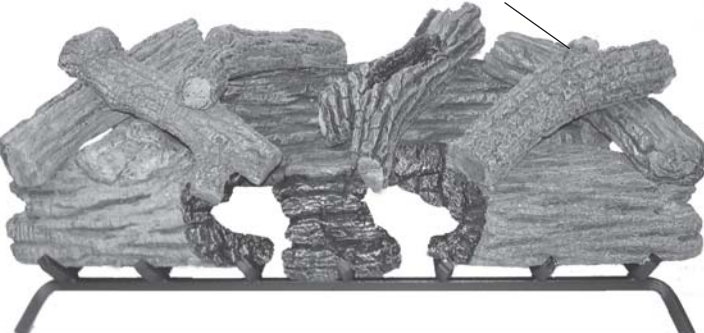

Figure 44 - Installing Top Right Log (#11)

Left Side Log (#6)

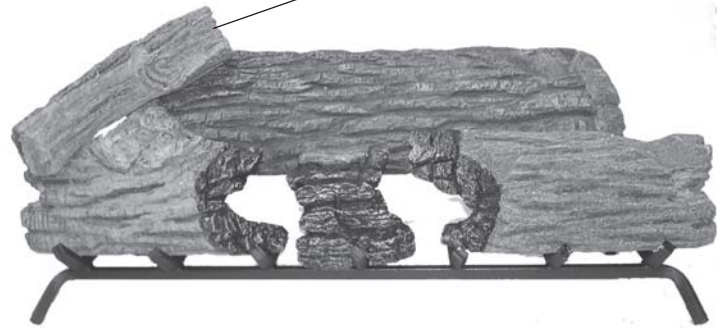

Figure 39 - Installing Left Side Log (#6)

Right Side Log (#8)

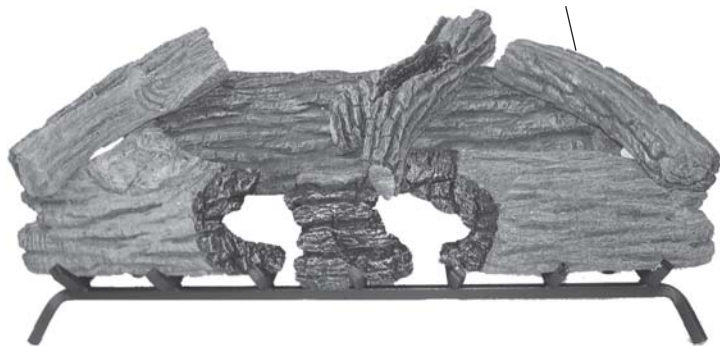

Figure 41 - Installing Right Side Log (#8)

Top Left Log (#9)

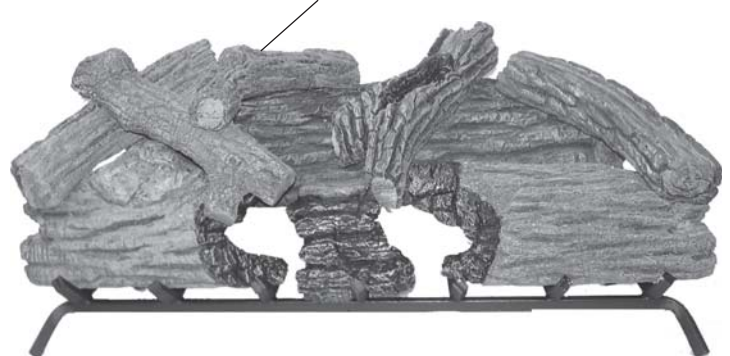

Figure 43 - Installing Top Left Log (#9)

Top Middle Log (#5)

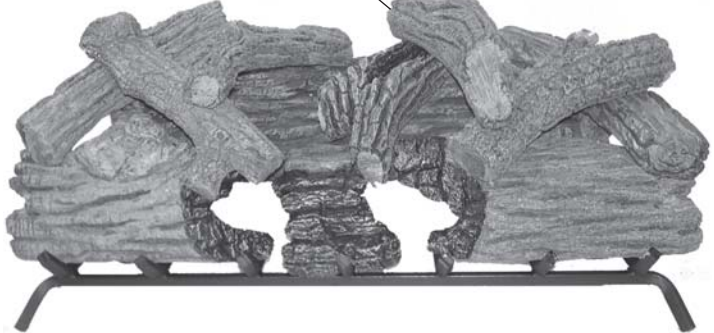

Figure 45 - Installing Top Middle Log (#5)

VWF18 AMERICAN OAK LOGS

NOTE: Each log has an identifying number embossed on bottom surface.

1. Place Back Log #2 on grate bars on back of grate. *See Figure 46.*
2. Place Front Log #1 on front of grate. *See Figure 47.*
3. Position Right/Left Middle Log #4 on top right of Log #1 and Log #2. *See Figure 48.*
4. Place Right/Left Middle Log #4 on top left of Log #1 and Log #2. *See Figure 49.*
5. Rest Top Right/Left Log #7 on Log # 4 and Log #1. *See Figure 50.*
6. Rest Top Right/Left Log #7 on Log #4 and Log #1. *See Figure 51.*

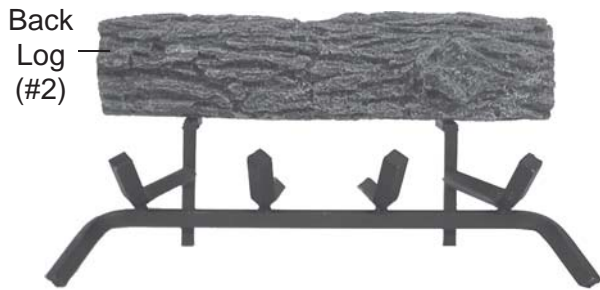

Figure 46 - Placing Back Log (#2) on Grate Bars in Back of Grate



Figure 47 - Placing Front Log (#1) on Front of Grate

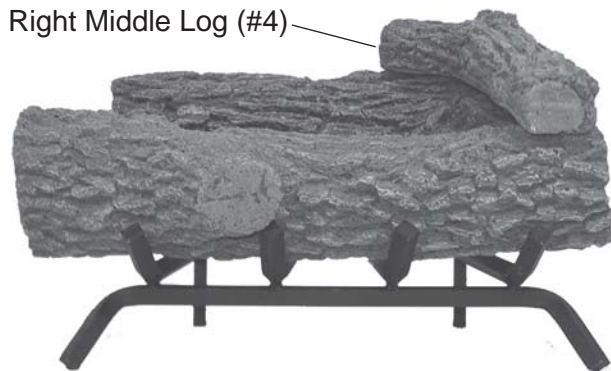

Figure 48 - Positioning Right/Left Middle Log (#4)



Figure 49 - Positioning Right/Left Middle Log (#4)

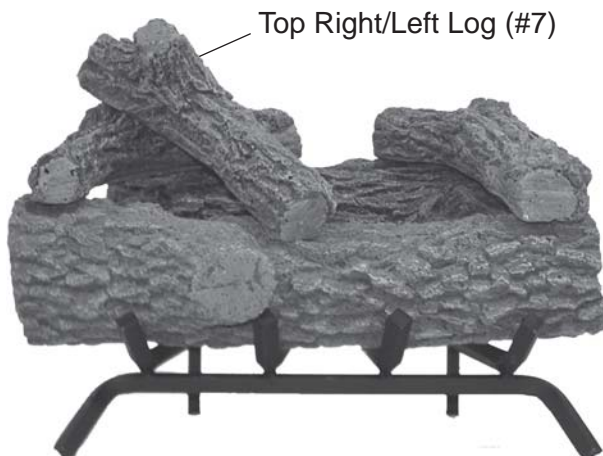

Figure 50 - Positioning Top Right/Left Log (#7)

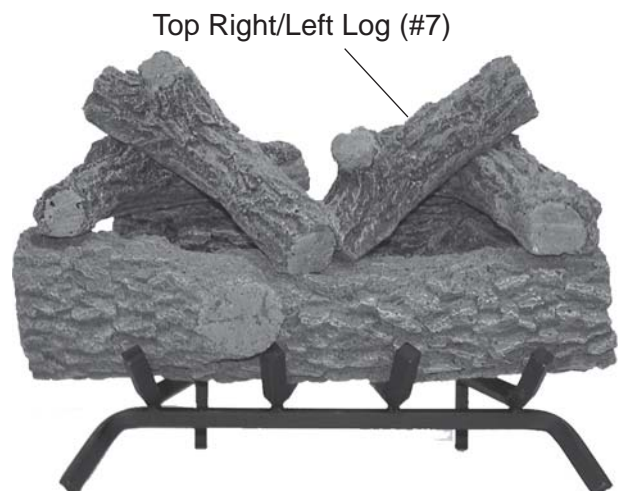

Figure 51 - Positioning Top Right/Left Log (#7)

LOG PLACEMENT

VWF24 AMERICAN OAK LOGS

1. Place Back Log #2 on grate bars on back of grate. *See Figure 52.*
2. Place Front Log #1 on front of grate. *See Figure 53.*
3. Position Right Log #3 on top right of Log #1 and Log #2. *See Figure 54.*
4. Place Right/Left Log #4 on top left of Log #1 and Log #2. *See Figure 55.*
5. Rest Right/Left Log #4 on Log #3 and Log #1. *See Figure 56.*
6. Rest Top Left Log #6 on Log #4 and Log #1. *See Figure 57.*

NOTE: Each log has an identifying number embossed on bottom surface.

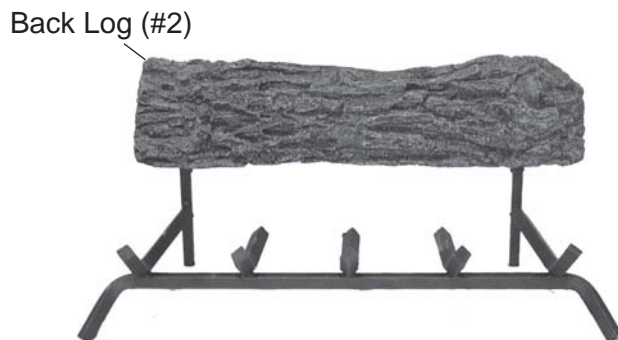

Figure 52 - Placing Back Log (#2) on Grate Bars in Back of Grate



Figure 53 - Placing Front Log (#1) on Front of Grate

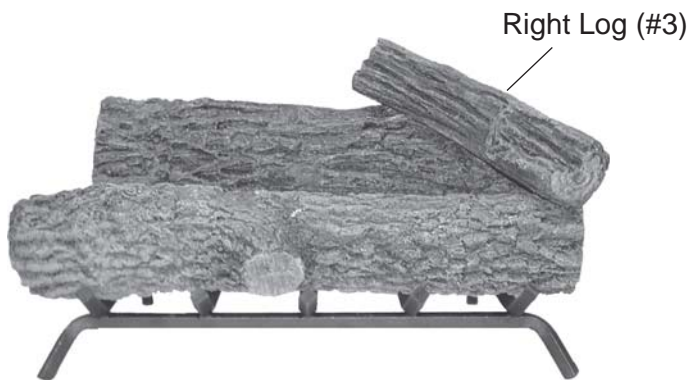

Figure 54 - Positioning Right Log (#3)

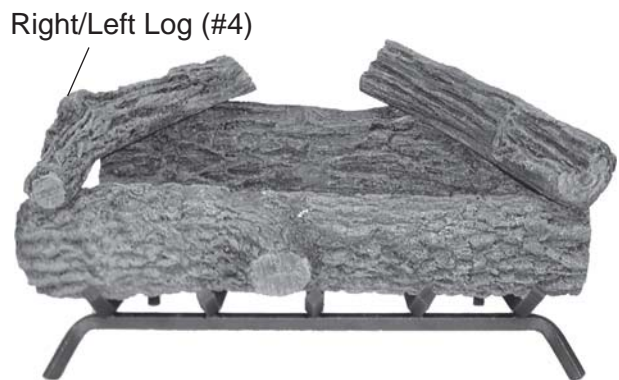

Figure 55 - Positioning Right/Left Log (#4)

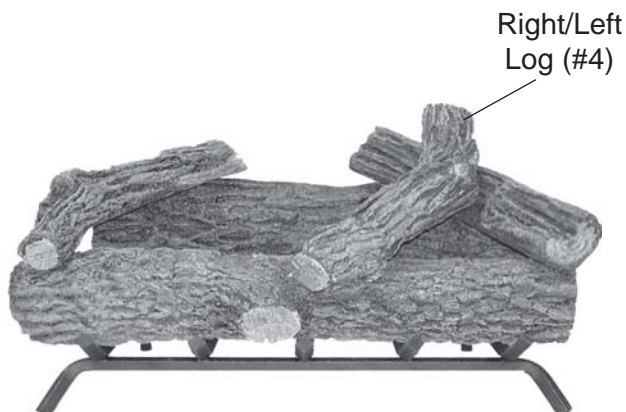

Figure 56 - Positioning Right/Left Log (#4)

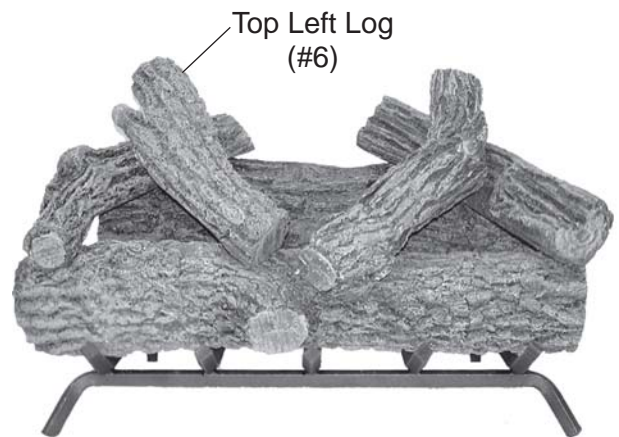

Figure 57 - Positioning Top Left Log (#6)

VWF30 AMERICAN OAK LOGS

1. Place Back Log #2 on grate bars on back of grate. *See Figure 58.*
2. Place Front Log #1 on front of grate. *See Figure 59.*
3. Position Right/Left Middle Log #4 on top right of Log #1 and Log #2. *See Figure 60.*
4. Place Right/Left Middle Log #4 on top left of Log #1 and Log #2. *See Figure 61.*
5. Rest Top Right/Left Log #5 on Log #4 and Log #1. *See Figure 62.*
6. Rest Top Right/Left Log #5 on Log 4 and Log #1. *See Figure 63.*

NOTE: Each log has an identifying number embossed on bottom surface.

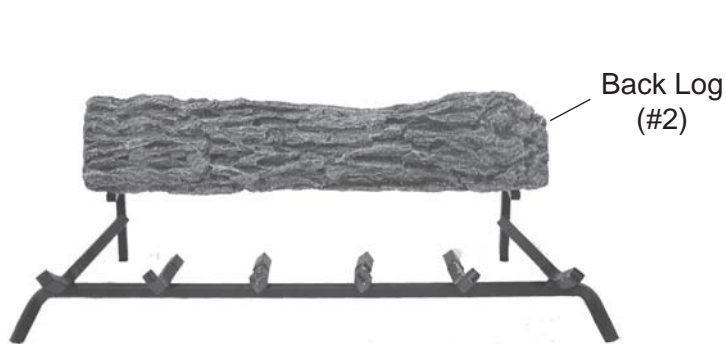

Figure 58 - Placing Back Log (#2) on Grate Bars on Back of Grate.

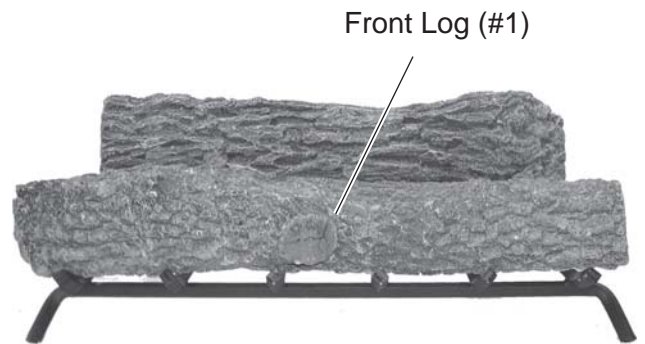

Figure 59 - Placing Front Log (#2) on Front Grate

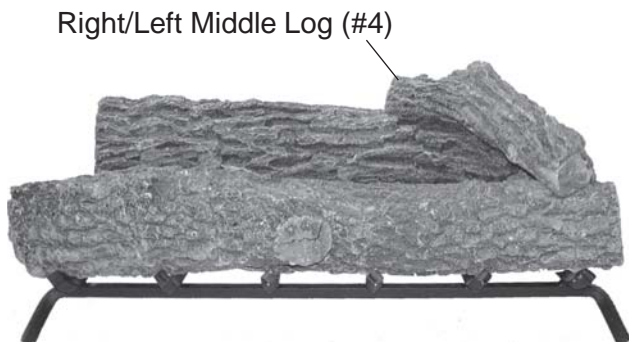

Figure 60 - Positioning Right/Left Middle Log (#4)

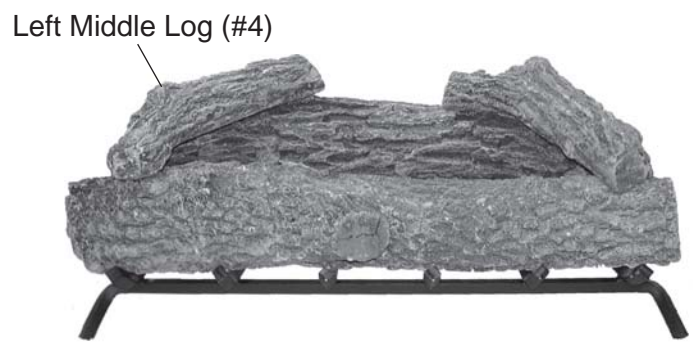

Figure 61 - Positioning Left Middle Log (#4)

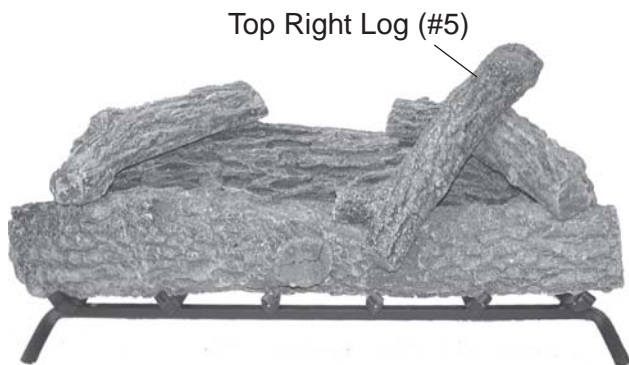

Figure 62 - Positioning Top Right/Left Log (#5)

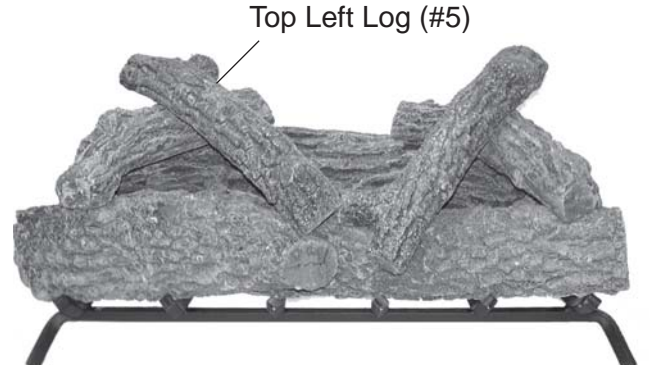

Figure 63 - Positioning Top Right/Left Log (#5)

Continued

LOG PLACEMENT

VWF30 AMERICAN OAK LOGS *(continued)*

7. Place Left Crossover Log #7 on Log #2 and Log #5. See *Figure 64*.
8. Place Right Crossover Log #8 on Log #5 and Log #7. See *Figure 65*.

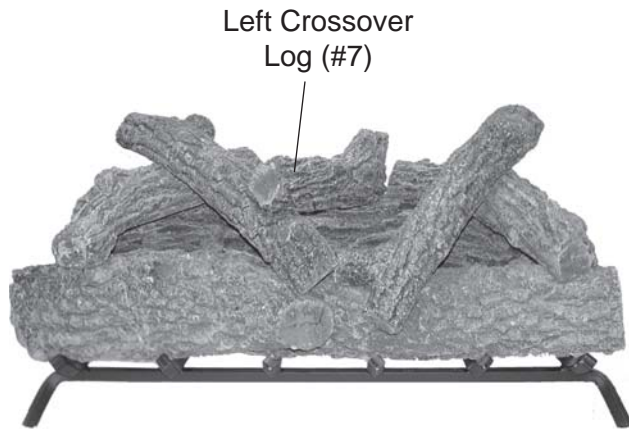

Figure 64 - Placing Left Crossover Log (#7)

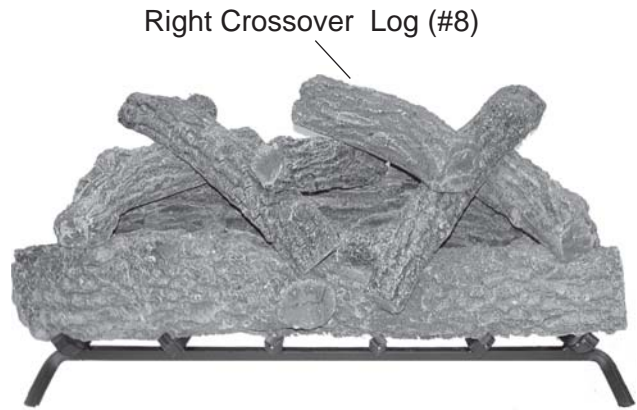
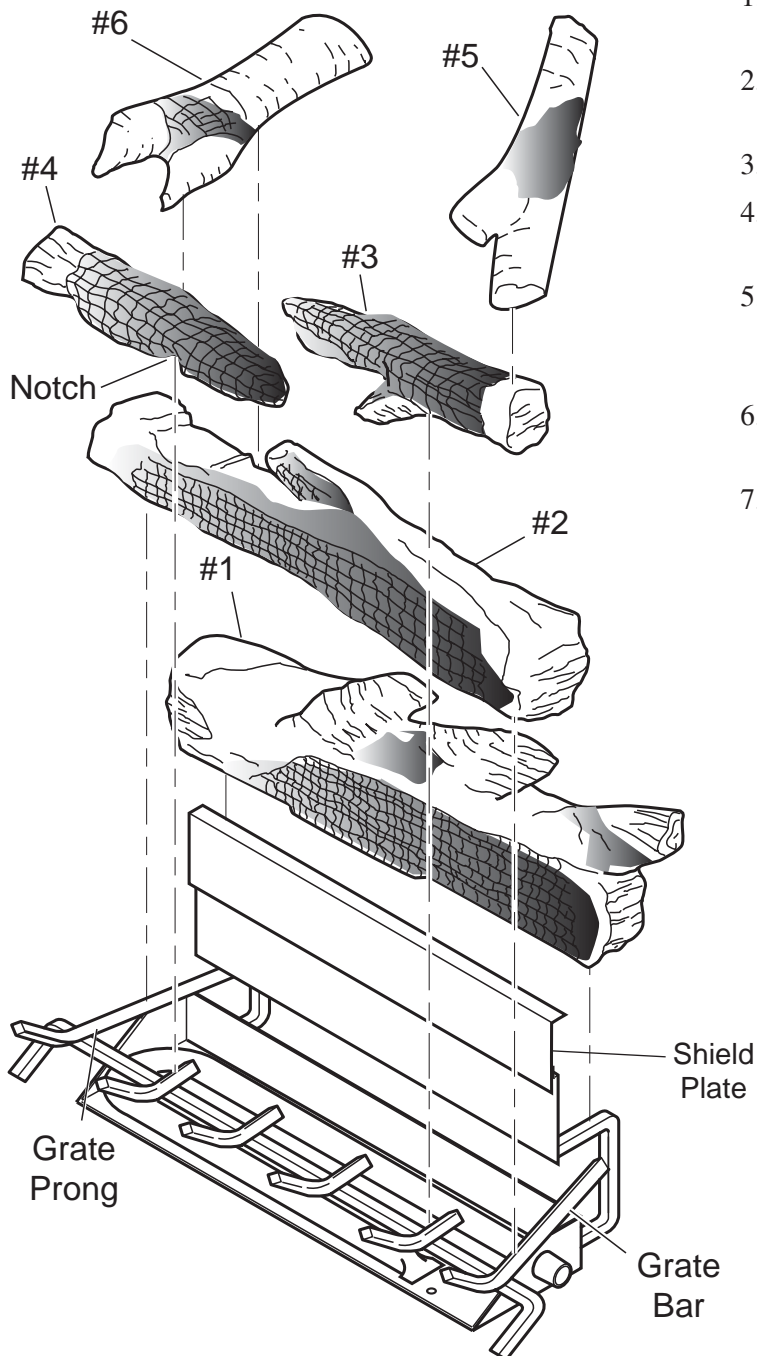

Figure 65 - Placing Right Crossover Log (#8)

MODELS VWF24 B (6 Logs)



1. Slide shield plate down back of burner pan. *See Figure 65.*
2. Place Back Log #1 on grate bars on back of grate. *See Figure 65.*
3. Place Middle Log #2 in front of Log #1. *See Figure 65.*
4. Position Right Front Log #3 on right front side of grate. *See Figure 65.*
5. Position Left Front Log #4 on left front side of grate. Make sure notch in bottom of log sits on grate prong. *See Figure 65.*
6. Rest Top Right Log #5 across top right sides of Log #1 and Log #2. *See Figure 65.*
7. Rest Top Left Log #6 across top left side of Log #1 and Log #2. *See Figure 65.*

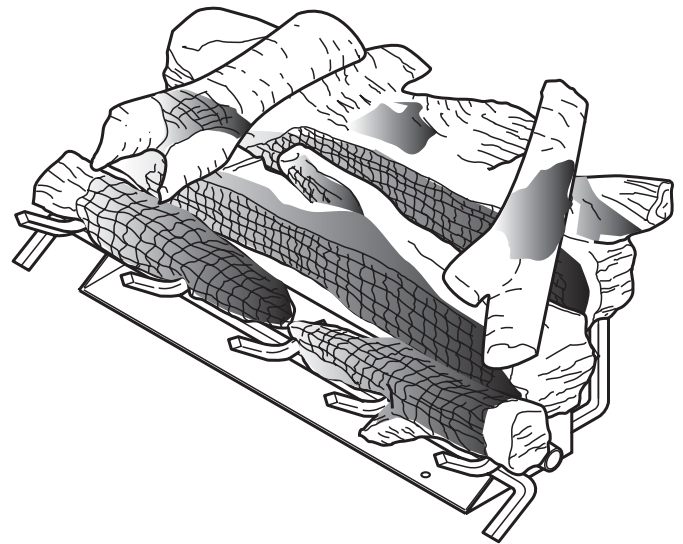

Figure 66 - VWF24B (Birch) Log Placement

Figure 65 - VWF24B (Birch) Log Placement

LOG PLACEMENT

MODELS VWF24/18 SPLIT RIVER OAK

1. Slide shield plate down back of burner pan. *See Figure 67.*
2. Place Back Log #1 on back of grate. *See Figure 68.*
3. Place Front Left Log #2 in front of back log on left arm of grate. Rest end of bottom left log between second and third prong of grate. *See Figure 69.*
4. Place end of Bottom Right Log #3 on cutout of back log #1. Rest other end of right bottom log to the outside of right grate prong. *See Figure 70.*
6. Rest Bottom Left Log #5 on back log #1 and to the outside of the left grate prong. *See Figure 71.*

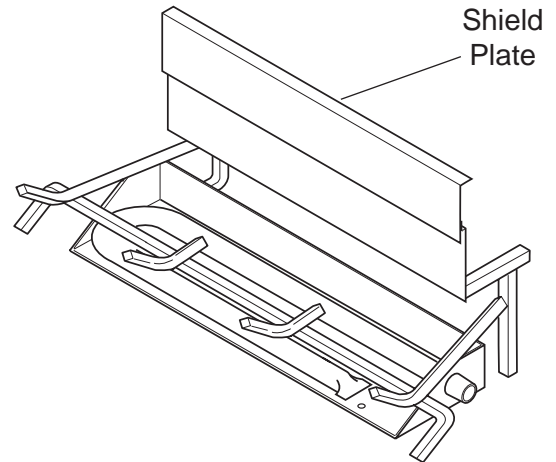

Figure 67 - Sliding Shield Plate Down Back of Burner Pan

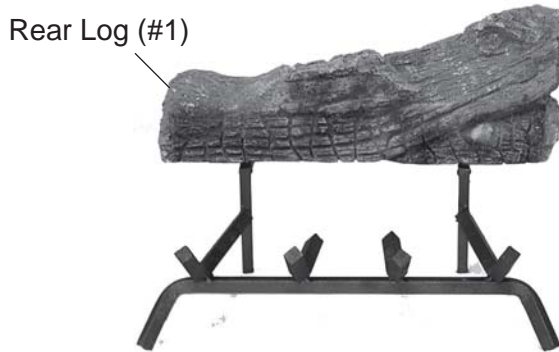

Figure 68 - Placing Rear Log (#1) on Back of Grate

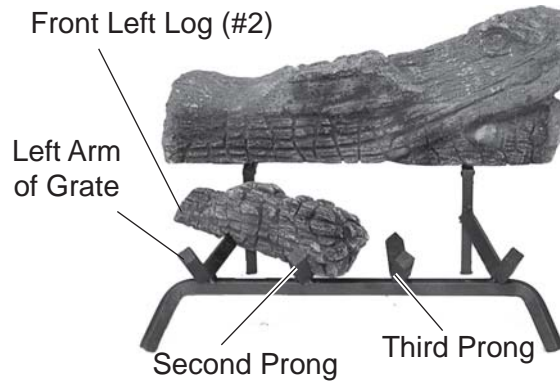

Figure 69 - Placing Front Left Log (#2) on Left Arm of Grate

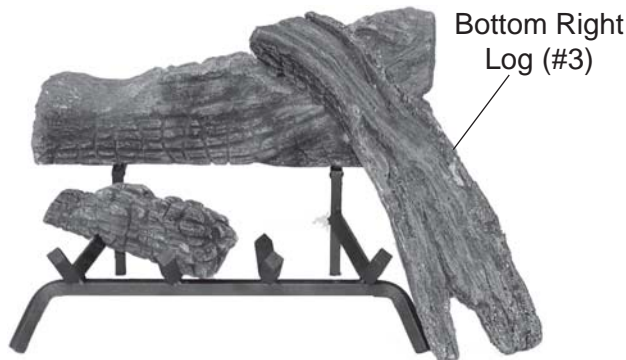

Figure 70 - Placing Bottom Right (#3) Log on Grate



Figure 71 - Installing Bottom Front Left Log (#5)

Continued

MODELS VWF24/18 SPLIT RIVER OAK (continued)

- 5. Rest right end of Top Right Log #4 on bottom right log. See Figure 72.
- 7. Place end of Top Left Log #6 on bottom left log. Rest the other end between the first and second grate prongs. See Figure 73.
- 8. Rest Top Center Log #7 on bottom left log #2 and back log #1. See Figure 74.

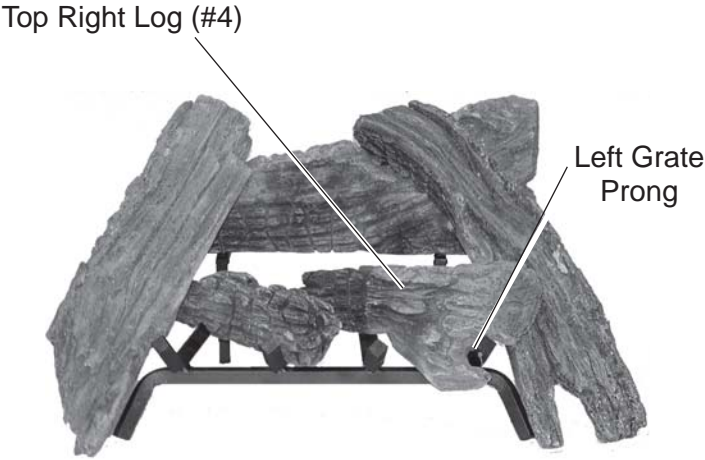

Figure 72 - Resting Top Right Log (#4) on Bottom Left Log

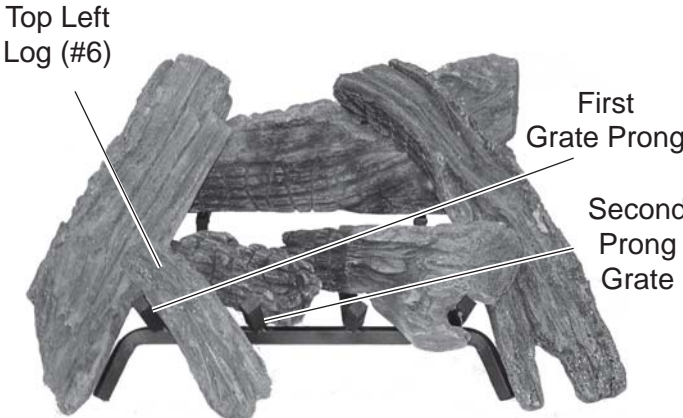

Figure 73 - Resting Top Left Log (#6) on Bottom Left Log and Back Log

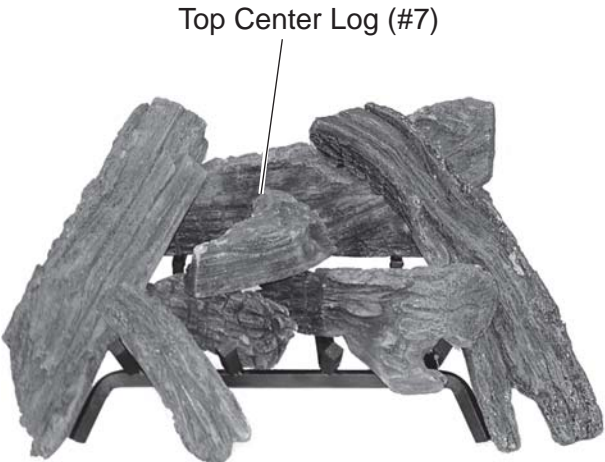

Figure 74 - Resting Center Top Log (#7) Bottom left Log and Back Log

LOG PLACEMENT

MODELS VWF30/24 SPLIT RIVER OAK

1. Slide shield plate down back of burner pan. *See Figure 75.*
2. Place Back Log #1 on back of grate. *See Figure 76.*
3. Place Front Left Log #2 in front of back log on left arm of grate. Rest end of bottom left log between second and third prong of grate. *See Figure 77.*
4. Place end of Bottom Right Log #3 on cutout of back log #1. Rest other end of right bottom log to the outside of right grate prong. *See Figure 78.*
5. Rest right end of Top Right Log #4 on bottom right log. *See Figure 79.*

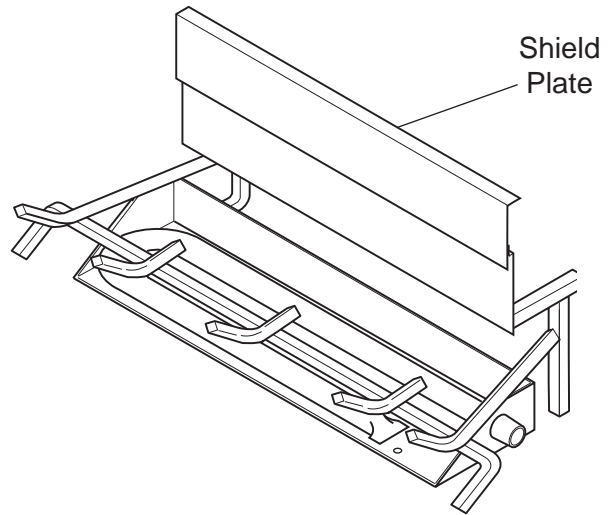

Figure 75 - Sliding Shield Plate Down Back of Burner Pan

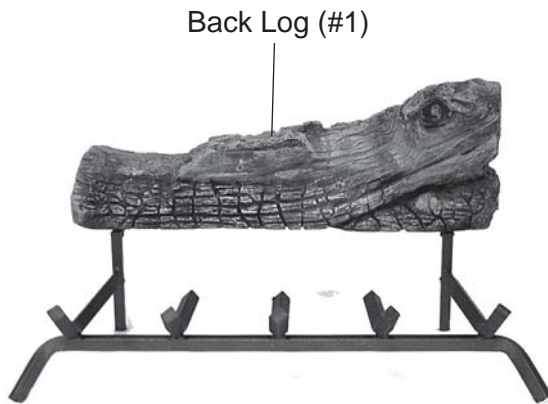

Figure 76 - Placing Rear Log (#1) on Back of Grate

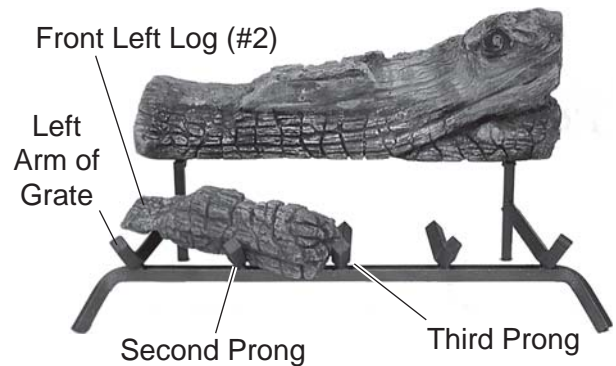

Figure 77 - Placing Front Left Log (#2) on Left Arm of Grate

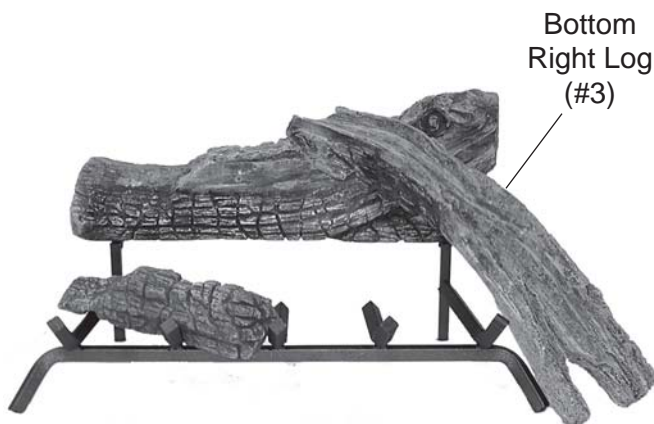

Figure 78 - Placing Bottom Right (#3) Log on Grate

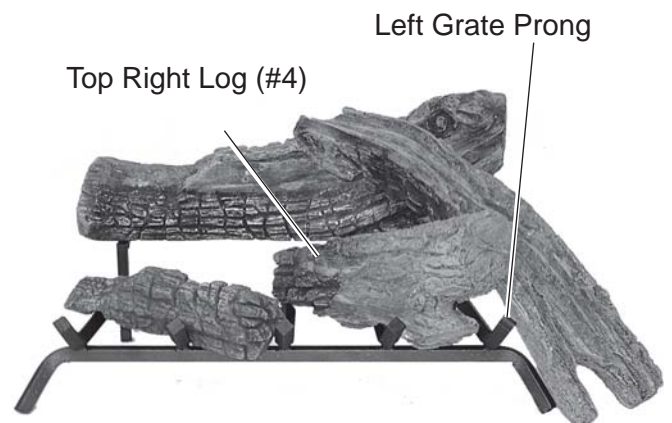

Figure 79 - Resting Top Right Log (#4) on Bottom Left Log

Continued

MODELS VWF30/24 SPLIT RIVER OAK (continued)

6. Rest Bottom Left Log #5 on back log #1 and to the outside of the left grate prong. See *Figure 80*.
7. Place end of Top Left Log #6 on bottom left log. Rest the other end between the first and second grate prongs. See *Figure 81*.
8. Rest Top Center Log #7 on bottom left log #2 and back log #1. See *Figure 82*.

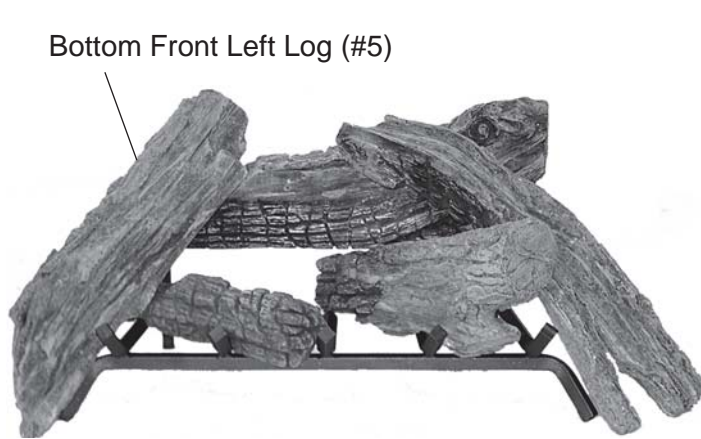

Figure 80 - Installing Bottom Front Left Log (#5)

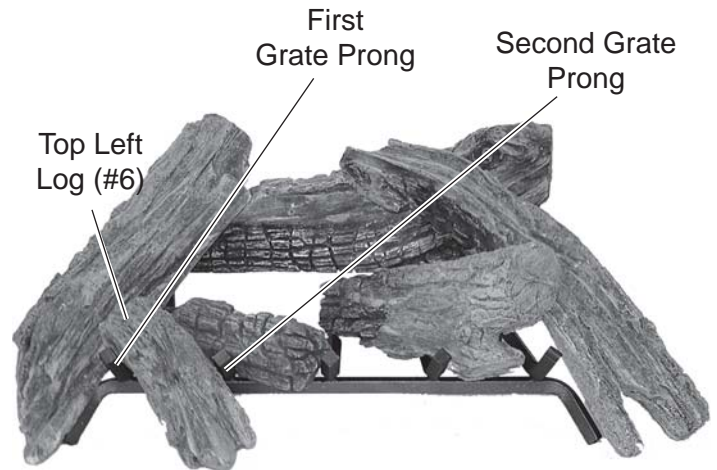

Figure 81 - Resting Top Left Log (#6) on Bottom Left Log and Back Log

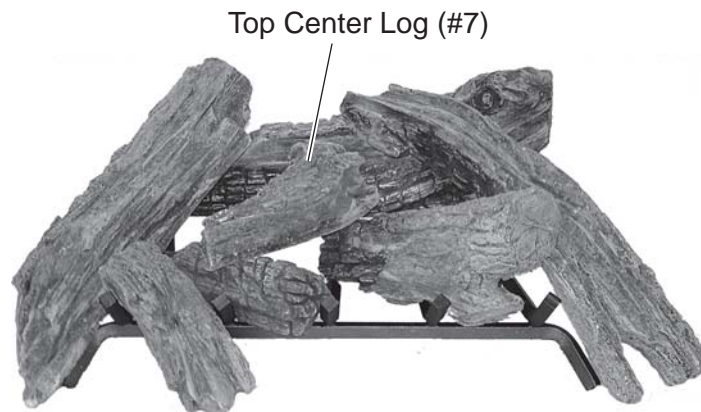

Figure 82 - Resting Center Top Log (#7) Bottom left Log and Back Log

LOG PLACEMENT

MODELS VWF36/30 SPLIT RIVER OAK

1. Slide shield plate down back of burner pan. *See Figure 83.*
2. Place Back Log #1 on back of grate. *See Figure 84.*
3. Place Front Left Log #2 in front of back log on left arm of grate. Rest end of bottom left log between third and fourth prong of grate. *See Figure 85.*
4. Place end of Bottom Right Log #3 on cutout of back log #1. Rest other end of right bottom log to the outside of right grate prong. *See Figure 86.*
5. Rest right end of Top Right Log #4 on bottom right log. *See Figure 87.*

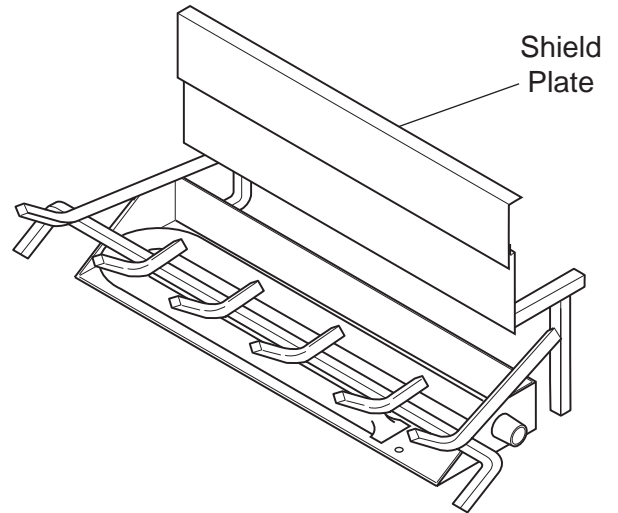

Figure 83 - Sliding Shield Plate Down Back of Burner Pan

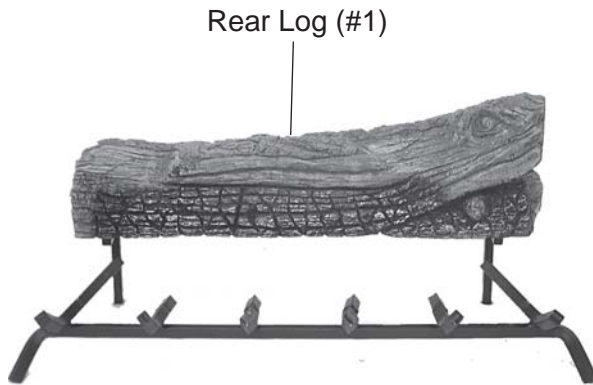

Figure 84 - Placing Rear Log (#1) on Back of Grate

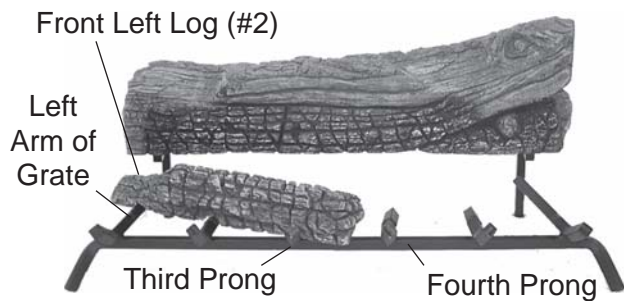

Figure 85 - Placing Front Left Log (#2) on Left Arm of Grate

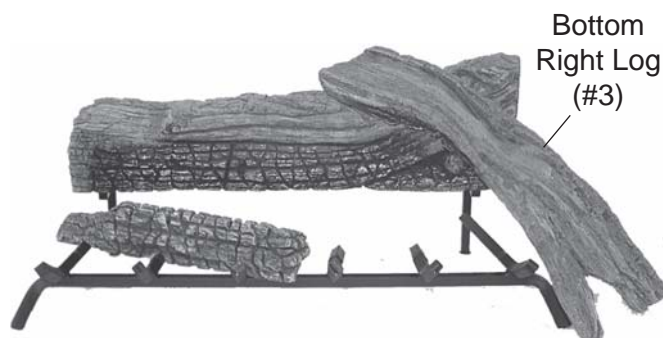

Figure 86 - Placing Bottom Right (#3) Log on Grate

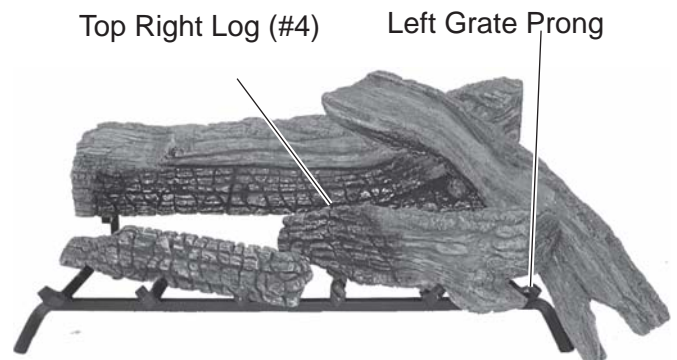

Figure 87 - Resting Top Right Log (#4) on Bottom Left Log

Continued

MODELS VWF36/30 SPLIT RIVER OAK (continued)

6. Rest Bottom Left Log #5 on back log #1 and to the outside of the left grate prong. *See Figure 88.*
7. Place end of Top Left Log #6 on bottom left log. Rest the other end between the first and second grate prongs. *See Figure 89.*
8. Rest Top Center Log #7 on bottom left log #2 and back log #1. *See Figure 90.*
9. Rest Right Front Log #8 on top right log #4 and front of burner pan. *See Figure 91.*

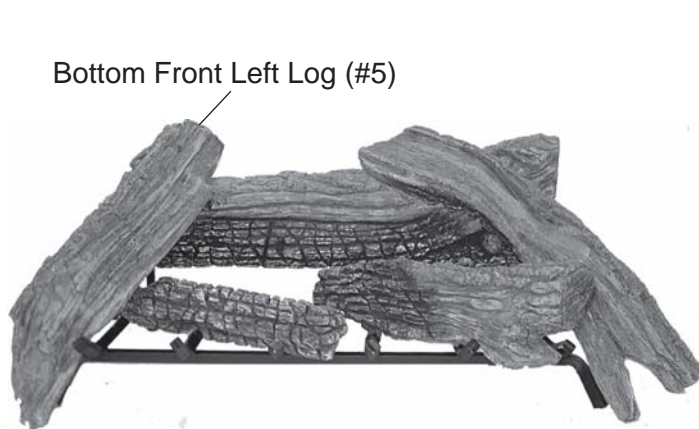

Figure 88 - Installing Bottom Front Left Log (#5)

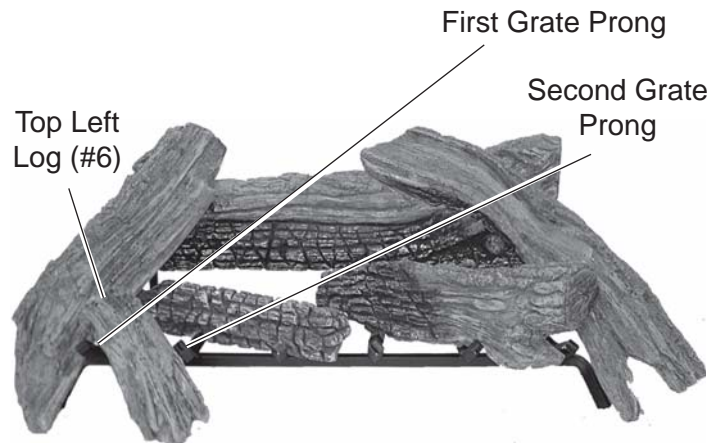

Figure 89 - Resting Top Left Log (#6) on Bottom Left Log and Back Log

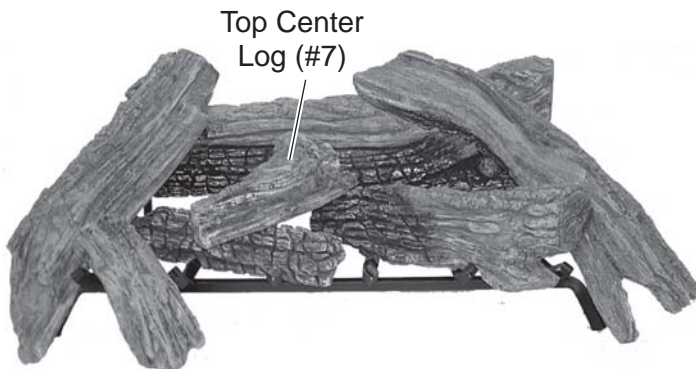

Figure 90 - Resting Center Top Log (#7) Bottom left Log and Back Log

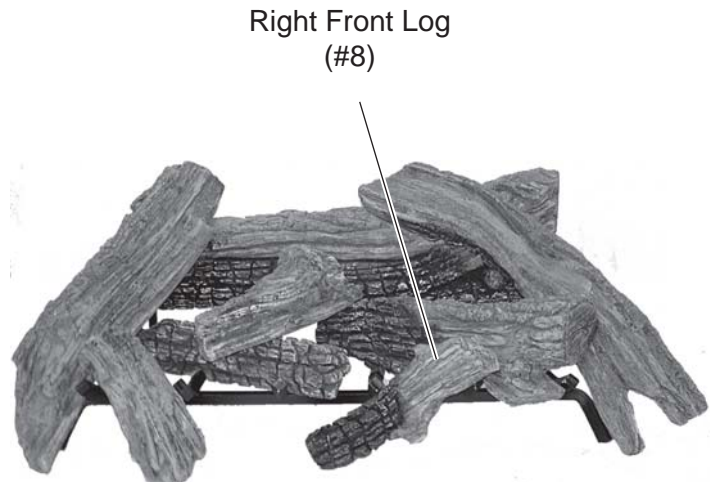

Figure 91 - Resting Front Right Log (#8) on Top Right Log and Front of Burner Pan

LOG PLACEMENT

MODELS VWF18 SPLIT PINE

1. Slide shield plate down back of burner pan. See Figure 92.
2. Place Left Front Log #1A on front left of grate. See Figure 93.
3. Place Right Front Log #1B on front right of the grate. See Figure 94.
4. Place front end of Side Support Log #2 on top left of Log #1A. Rest other end of Log #2 on rear grate bar. See Figure 95.
5. Fit cutout in the bottom left of Rear Log #3 over the back end of log #1A. Rest right end of Log #3 on rear grate bar. See Figure 96.

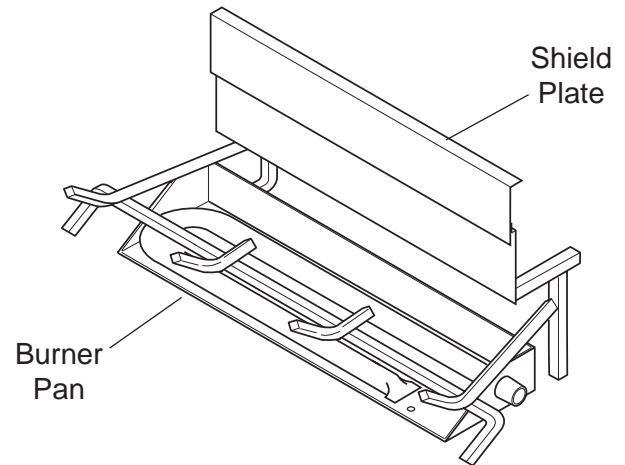

Figure 92- Sliding Shield Plate Down Back of Burner Pan

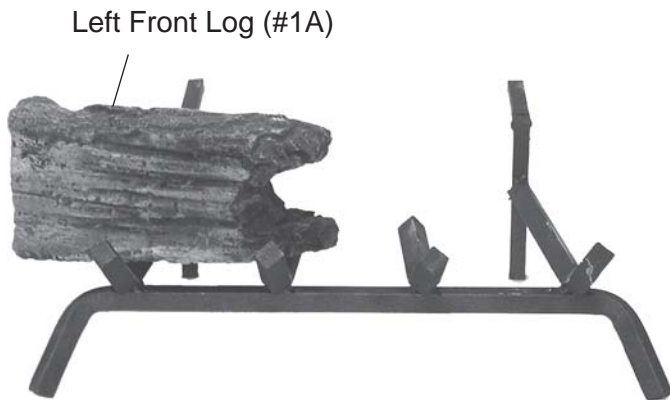

Figure 93 - Placing Left Front Log #1A on Grate

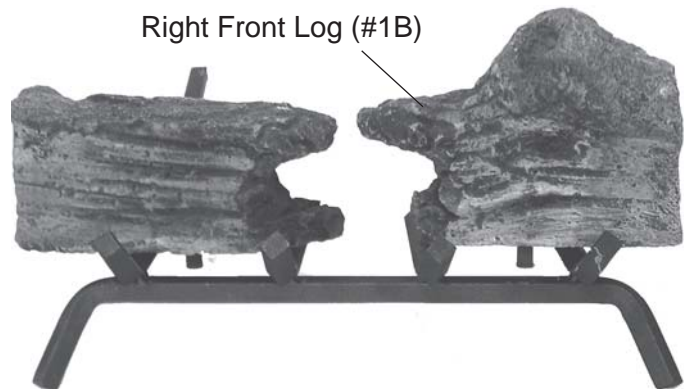

Figure 94 - Placing Right Front Log (#1B) on Grate

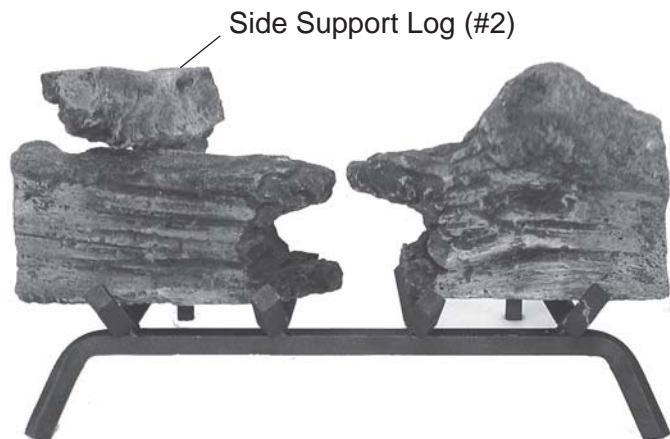

Figure 95 - Placing Side Support Log (#2) on Top Left of Log #1A

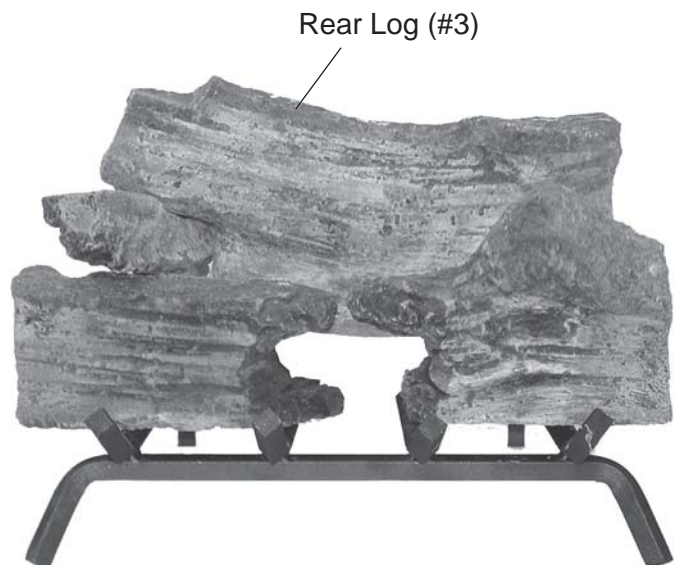

Figure 96 - Installing Rear Log #3

Continued

MODELS VWF18 SPLIT PINE (continued)

6. Rest front end of Right Log #6 on right top of Log #1B. The back end of Log #6 rests to right hump on Log #3. See Figure 97.
7. Place front of Right Middle Log #5 on top right of Log #4. Rest back end of Log #5 on top right of Log #3. See Figure 98.
8. Lay Top Center Log #7 across log #5 with front end resting on Log #1. See Figure 99.
9. Place front end of Top Left Log #8 on Log #7. Let back end of Log #8 rest on Log #6. See Figure 100.

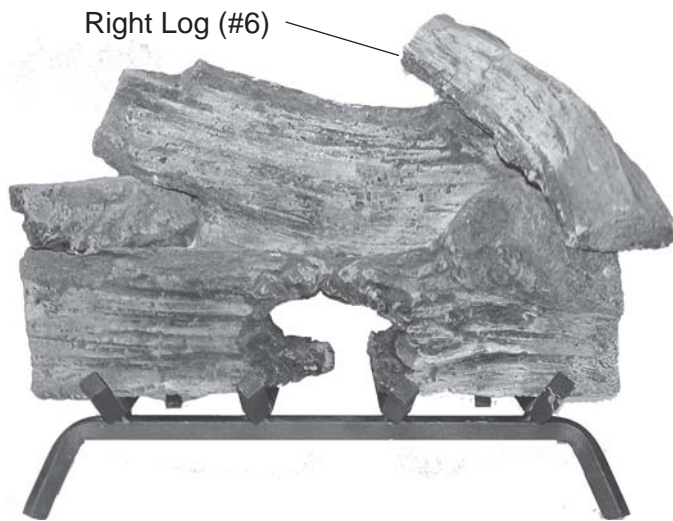

Figure 97 - Installing Right Log (#6)



Figure 98 - Installing Right Middle Log (#5)



Figure 99 - Installing Top Center Log (#7)



Figure 100 - Installing Top Left Log (#8)

LOG PLACEMENT

MODELS VWF24 SPLIT PINE

1. Slide shield plate down back of burner pan. *See Figure 101.*
2. Place Left Front Log #1A on front left of grate. *See Figure 102.*
3. Place Right Front Log #1B on front right of the grate. *See Figure 103.*
4. Place front end of Side Support Log #2 on top left of Log #1A. Rest other end of Log #2 on rear grate bar. *See Figure 104.*
5. Fit cutout in the bottom left of Rear Log #3 over the back end of Log #2. Rest right end of Log #3 on rear grate bar. *See Figure 105.*

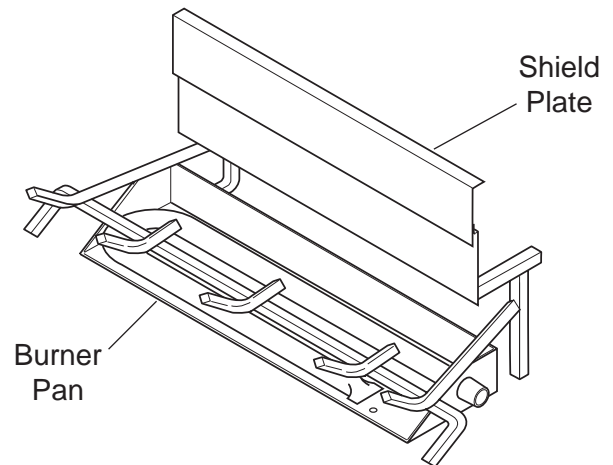

Figure 101 - Sliding Shield Plate Down Back of Burner Pan

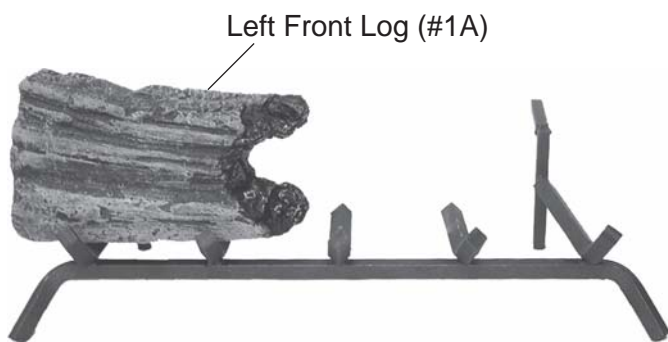

Figure 102 - Placing Left Front Log #1A on grate

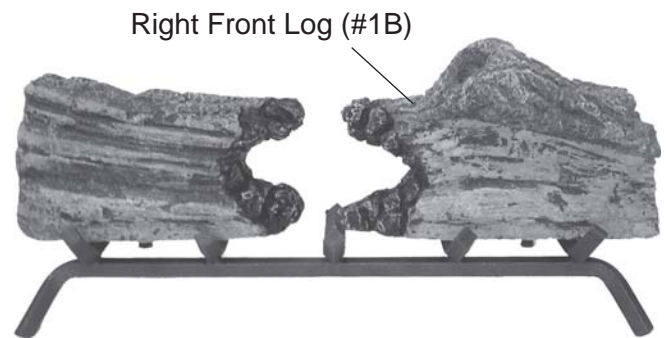

Figure 103 - Placing Right Front Log (#1B) on grate

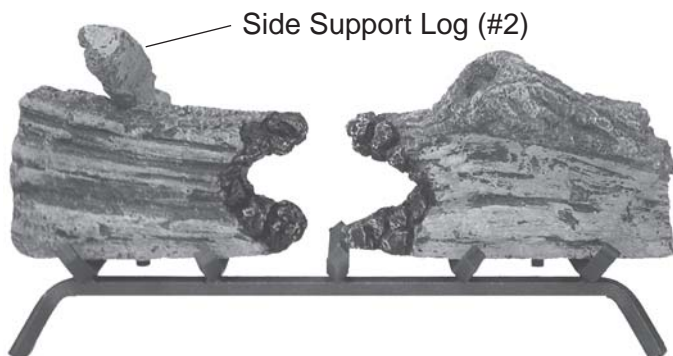

Figure 104 - Placing Side Support Log (#2) on Top Left of Log #1A

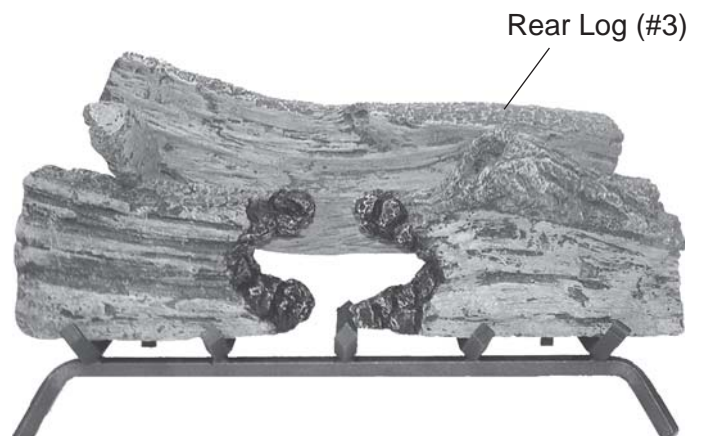

Figure 105 - Installing Rear Log #3

Continued

MODELS VWF24 SPLIT PINE (continued)

6. Rest front end of Right Log #4 on right top of Log #1B. The back end of Log #4 rests to right hump on Log #3. See Figure 106.
7. Place front of Right Middle Log #5 on top right of Log #1B. Rest back end of Log #5 on top right of Log #4. See Figure 107.
8. Rest front of Left Log #6 just left of the middle of Log #1A and back end of Log #6 just left of middle of Log #3. See Figure 108.
9. Lay Top Center Log #7 across log #3 with front end resting on Log #5. See Figure 109.
10. Place front end of Top Left Log #8 on Log #7. Let back end of Log #8 rest on Log #6. See Figure 110.

Right Log (#4)



Figure 106 - Installing Right Log (#4)

Right Middle Log (#5)

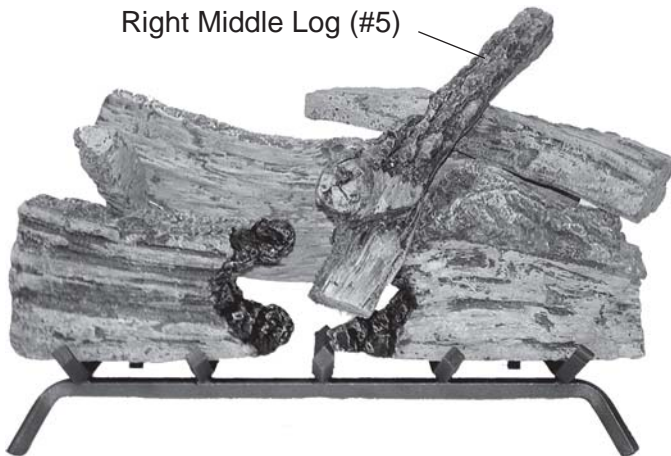

Figure 107 - Installing Right Middle Log (#5)

Left Log (#6)

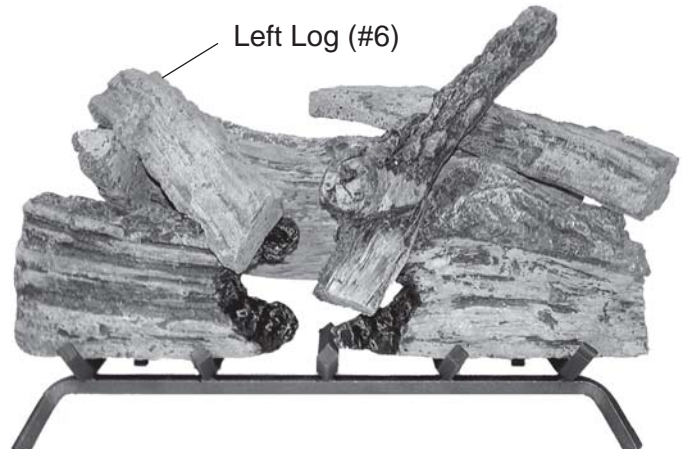

Figure 108 - Installing Left Log (#6)

Top Center Log (#7)



Figure 109 - Installing Top Center Log (#7)

Top Left Log (#8)



Figure 110 - Installing Top Left Log (#8)

LOG PLACEMENT

MODELS VWF30 SPLIT PINE

1. Slide shield plate down back of burner pan. *See Figure 111.*
2. Place Left Front Log #1A on front left of grate. *See Figure 112.*
3. Place Right Front Log #1B on front right of the grate. *See Figure 113.*
4. Place front end of Side Support Log #2 on top left of Log #1A. Rest other end of Log #2 on rear grate bar. *See Figure 114.*
5. Fit cutout in the bottom left of Rear Log #3 over the back end of log #2. Rest right end of Log #3 on rear grate bar. *See Figure 115.*

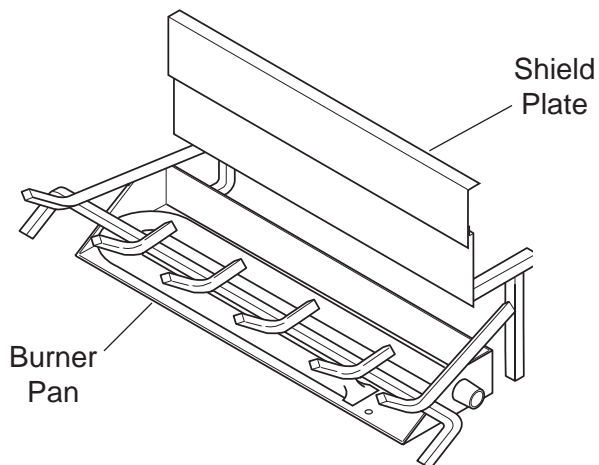

Figure 111 - Sliding Shield Plate Down Back of Burner Pan

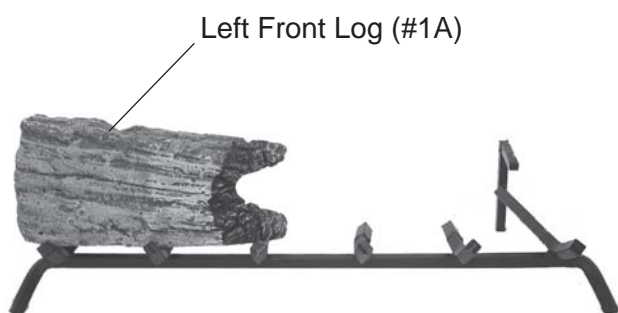

Figure 112 - Placing Left Front Log #1A on Grate

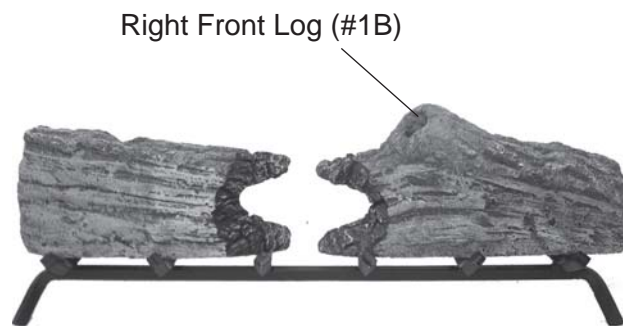

Figure 113 - Placing Right Front Log (#1B) on Grate

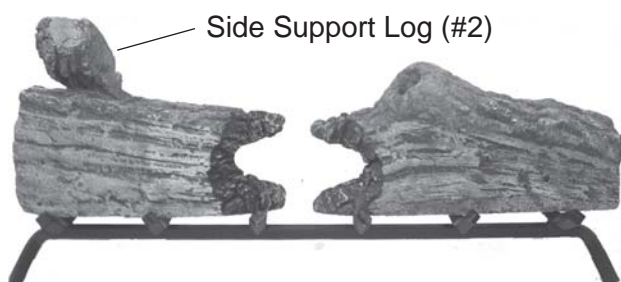

Figure 114 - Placing Side Support Log (#2) on Top Left of Log #1A

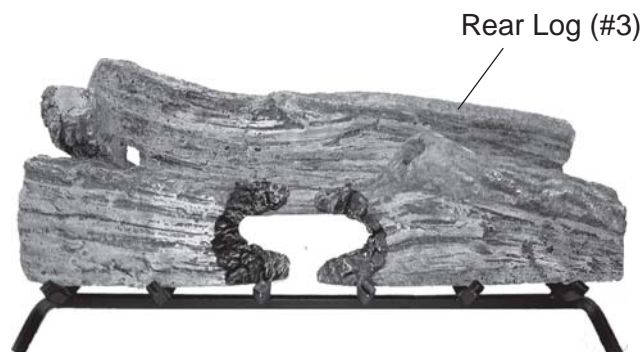
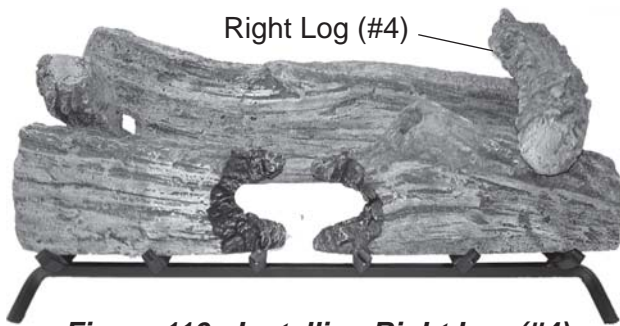
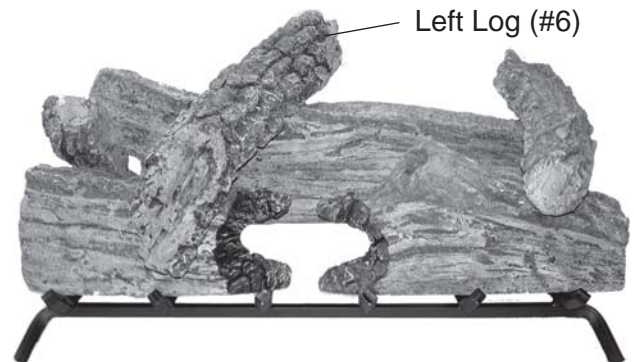
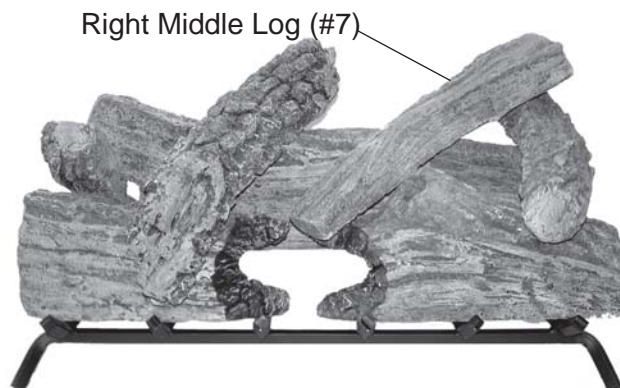
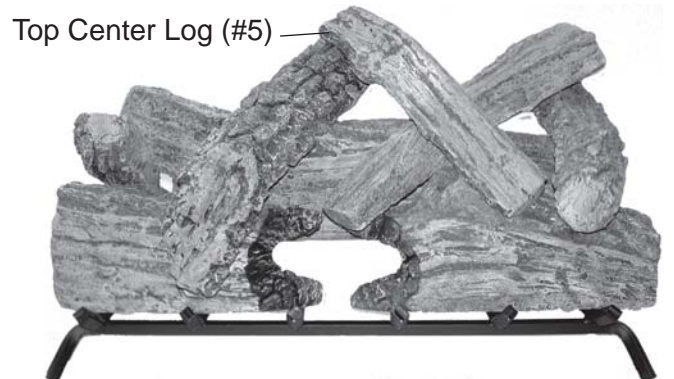
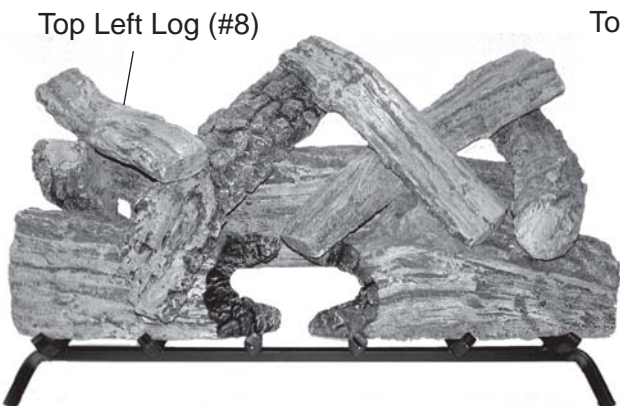

Figure 115 - Installing Rear Log #3

Continued

MODELS VWF30 SPLIT PINE (continued)

6. Rest front end of Right Log #4 on right top of Log #1B. The back end of Log #4 rests to right hump on Log #3. See Figure 116.
7. Rest front of Left Log #6 just left of the middle of Log #1A and back end of Log #6 just left of middle of Log #3. See Figure 117.
8. Place front of Right Middle Log #7 on top right of Log #1B. Rest back end of Log #5 on top right of Log #4. See Figure 118.
9. Lay Top Center Log #5 across log #7 with front end resting on Log #1B. See Figure 119.
10. Place front end of Top Left Log #8 on Log #6. Let back end of Log #8 rest on Log #3. See Figure 120.
11. Rest front of Top Top Log #9 on Log #8 and back of Log #9 on left end of Log #3. See Figure 121.

**Figure 116 - Installing Right Log (#4)****Figure 117 - Installing Left Log (#6)****Figure 118 - Installing Right Middle Log (#7)****Figure 119 - Installing Top Center Log (#5)****Figure 120 - Installing Top Left Log (#8)****Figure 121 - Installing Top Top Left Log (#9)**

LOG PLACEMENT

MODEL VWF24/18WP WEATHERED PINE LOG

1. Slide shield plate down back of burner pan. See Figure 122.
2. Place Rear Log #1 on back of grate. Left side should fit on grate in front of rear stand. Right side goes on the rear stand of grate. See Figure 123.
3. Place Bottom Right Log #2 along outside of grate. Rest end on Rear Log #1. Control knob will stick through bottom notch of log. See Figure 124.
4. Place Bottom Left Log #3 on grate. The “V” of the log should straddle the end grate bar. See Figure 125.
5. Place Top Right Log #4 on Bottom Right Log #2 resting on grate. See Figure 126.

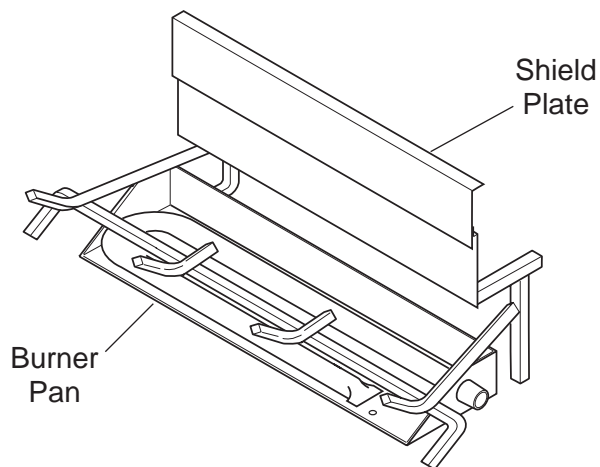

Figure 122 - Sliding Shield Plate Down Back of Burner Pan

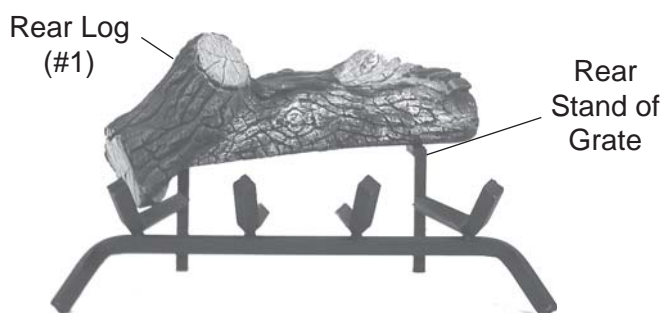

Figure 123 - Placing Rear Log #1 on Back Grate

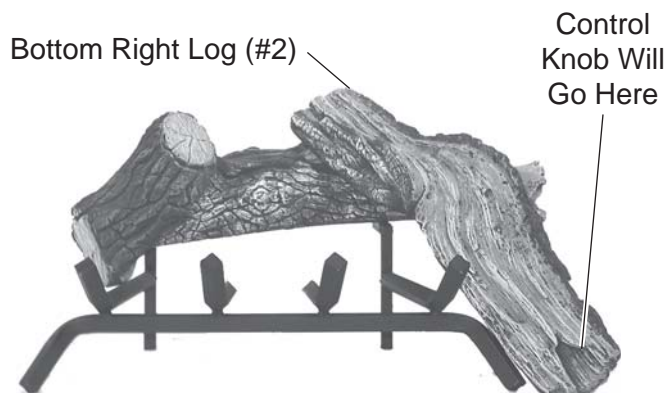

Figure 124 - Placing Bottom Right Log (#2)

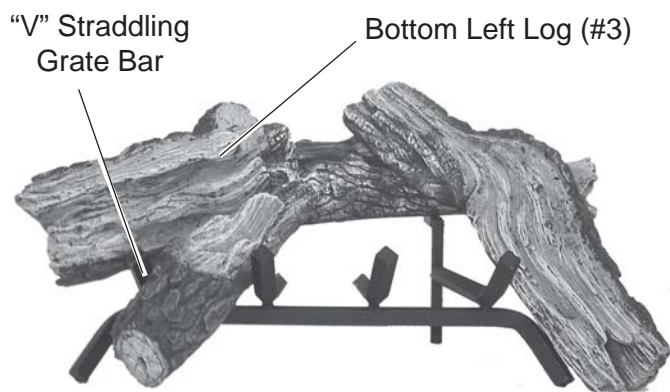

Figure 125 - Straddling “V” of Bottom Left Log (#3) on Grate Bar

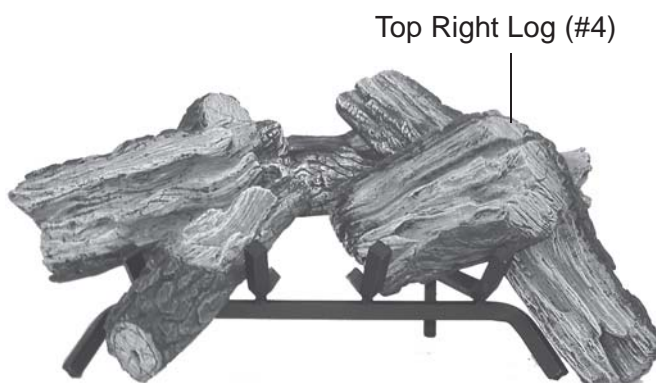

Figure 126 - Placing Top Right Log (#4)

MODEL VWF24/18WP WEATHERED PINE LOG (continued)

6. Place Top Left Log #5 behind Rear Log #1 on the notch on rear left of grate stand. *See Figure 127.*
7. Place Mid Front Log #6 on grate between center and middle left grate bars. Fit notch on back of log on the cross grate bar. *See Figure 128.*

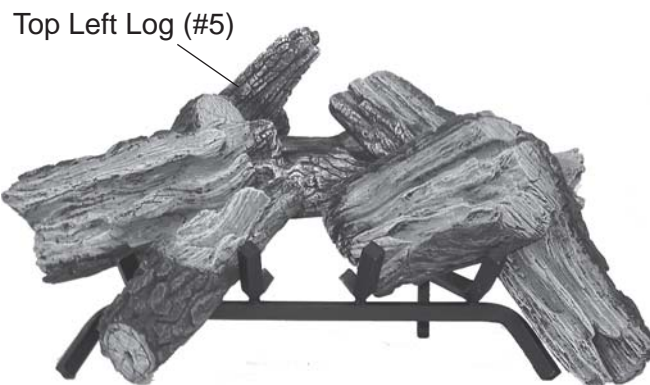

Figure 127 - Placing Top Left Log (#5) behind Rear Log

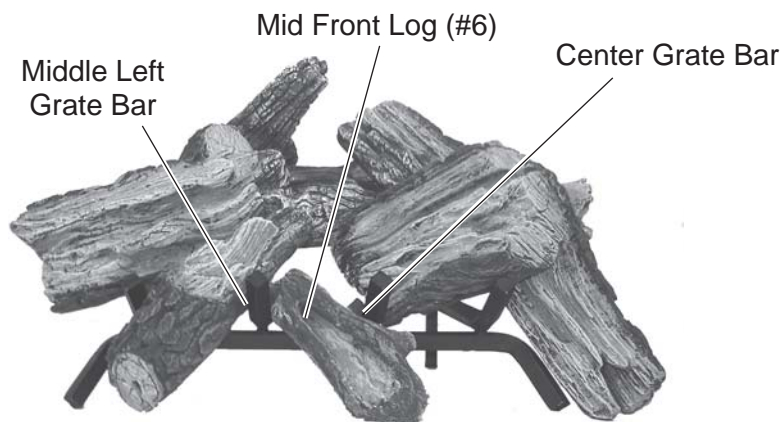

Figure 128 - Placing Mid Front Log (#6) on Grate Between Center and Middle Left Grate Bars.

LOG PLACEMENT

MODEL VWF30/24WP WEATHERED PINE LOG

1. Slide shield plate down back of burner pan. *See Figure 129.*
2. Place Rear Log #1 on back of grate. Left side should fit on grate in front of rear stand. Right side goes on the rear stand of grate. *See Figure 130.*
3. Place Bottom Right Log #2 along outside of grate. Rest end on Rear Log #1. Control knob will stick through bottom notch of log. *See Figure 131.*
4. Place Top Right Log #4 on Bottom Right Log #2 resting on grate. *See Figure 132.*
5. Place Bottom Left Log #3 on grate. The “V” of the log should straddle the end grate bar. *See Figure 133.*

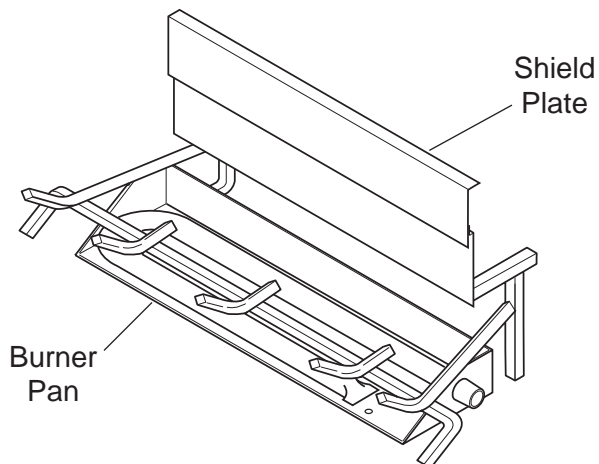

Figure 129 - Sliding Shield Plate Down Back of Burner Pan

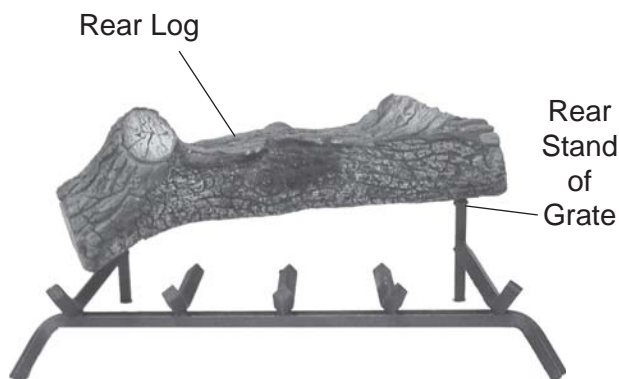

Figure 130 - Placing Rear Log #1 on Back Grate

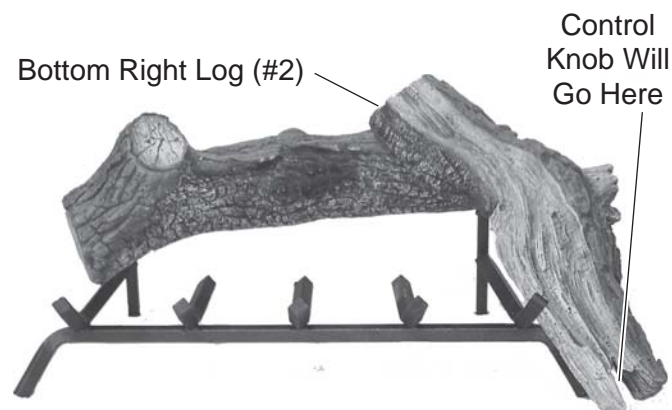

Figure 131 - Placing Bottom Right Log (#2)

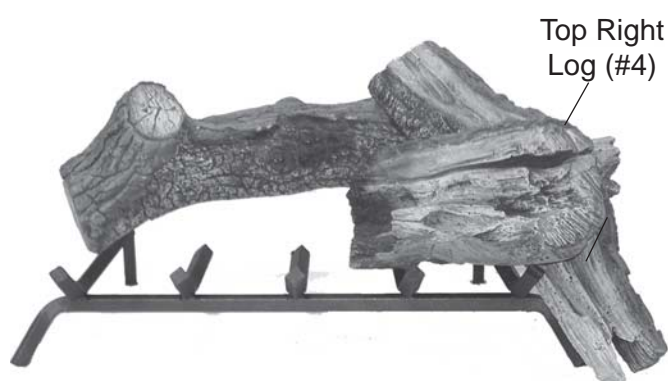

Figure 132 - Placing Top Right Log (#4)

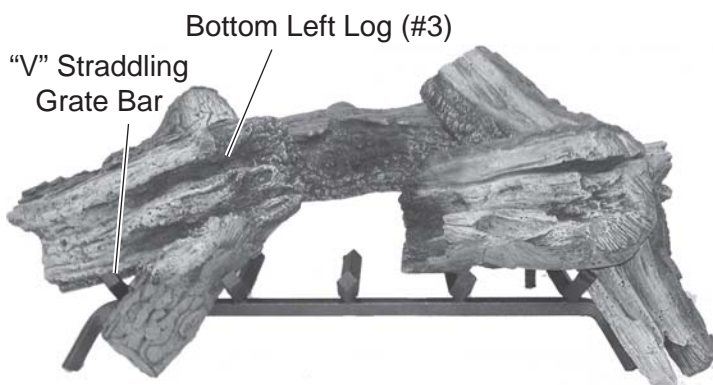

Figure 133 - Straddling "V" of Bottom Left Log (#3) on Grate Bar

MODEL VWF30/24WP WEATHERED PINE LOG (continued)

6. Place Top Left Log #5 behind Rear Log #1 on the notch on rear left of grate stand. *See Figure 134.*
7. Place Mid Front Log #6 on grate between center and middle left grate bars. Fit notch on back of log on the cross grate bar. *See Figure 135.*
8. Place wide end of Top Center Log #7 on Rear Log #1. Rest narrow end of Top Center Log #7 to the left of center grate bar barely touching the Mid Log #6. *See Figure 136.*

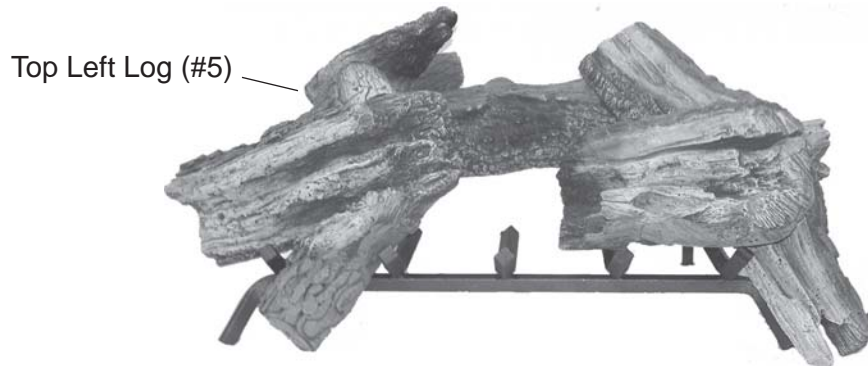

Figure 134 - Placing Top Left Log (#5) behind Rear Log

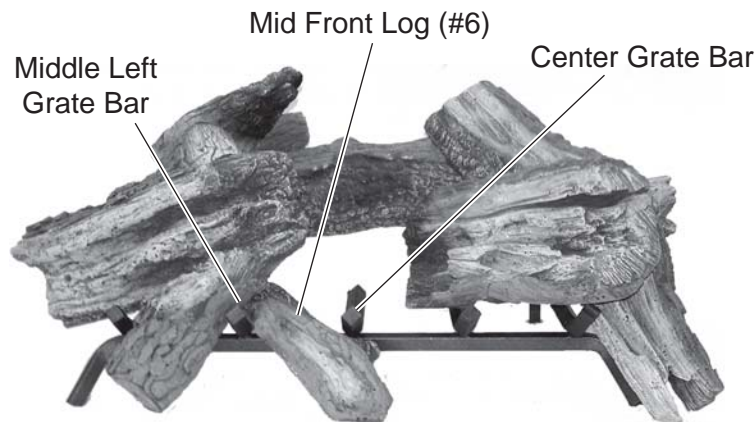

Figure 135 - Placing Mid Front Log (#6) on Grate Between Center and Middle Left Grate Bars.

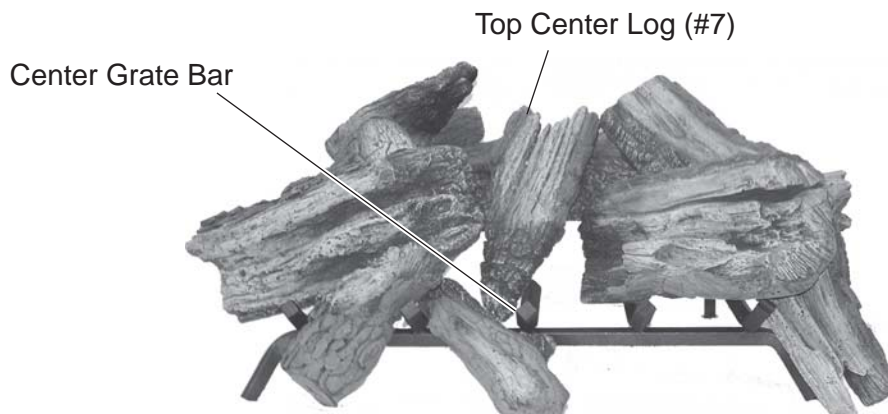

Figure 136 - Placing Top Center Log (#7) on Rear Log

LOG PLACEMENT

MODEL VWF36/30WP WEATHERED PINE LOG

1. Slide shield plate down back of burner pan. *See Figure 137.*
2. Place Rear Log #1 on back of grate. Left side should fit on grate in front of rear stand. Right side goes on the rear stand of grate. *See Figure 138.*
3. Place Bottom Right Log #2 along outside of grate. Rest end on Rear Log #1. Control knob will stick through bottom notch of log. *See Figure 139.*
4. Place Bottom Left Log #3 on grate. The “V” of the log should straddle the end grate bar. *See Figure 140.*
5. Place Top Right Log #4 on Bottom Right Log #2 resting on grate. *See Figure 141.*

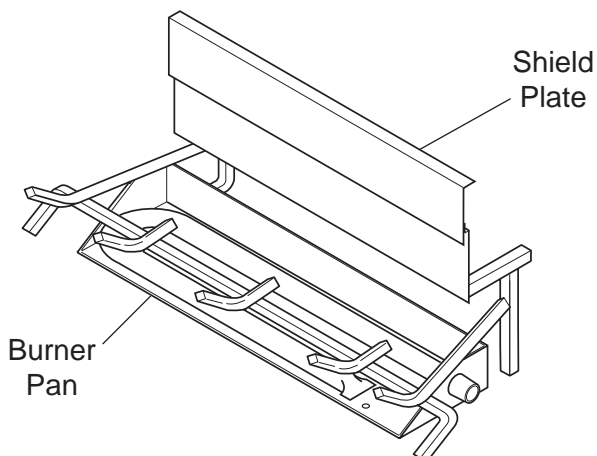

Figure 137 - Sliding Shield Plate Down Back of Burner Pan

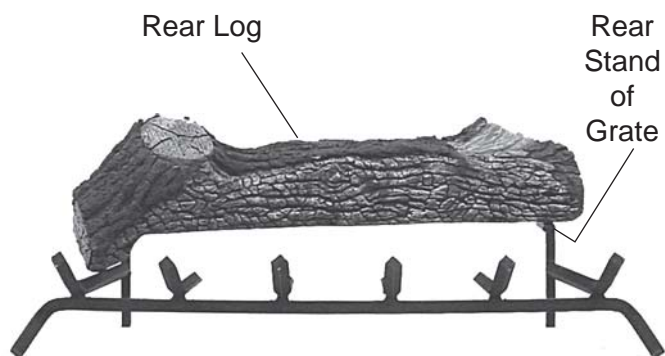

Figure 138 - Placing Rear Log #1 on Back Grate

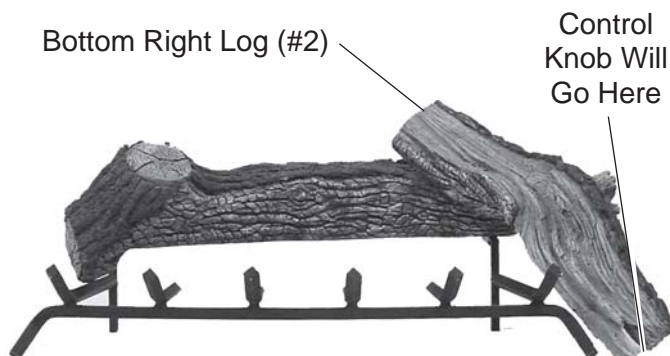

Figure 139 - Placing Bottom Right Log (#2)

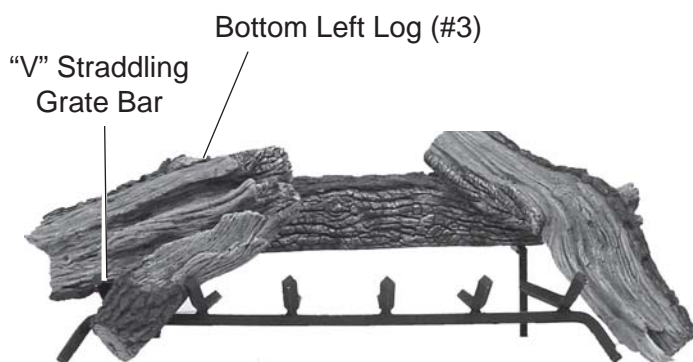

Figure 140 - Straddling “V” of Bottom Left Log (#3) on Grate Bar



Figure 141 - Placing Top Right Log (#4)

MODEL VWF36/30WP WEATHERED PINE LOG (continued)

6. Place Top Left Log #5 behind Rear Log #1 on the notch on rear left of grate stand. *See Figure 142.*
7. Place Mid Front Log #6 on grate between center and middle left grate bars. Fit notch on back of log on the cross grate bar. *See Figure 143.*
8. Place wide end of Top Center Log #7 on Rear Log #1. Rest narrow end of Top Center Log #7 to the left of center grate bar barely touching the Mid Log #6. *See Figure 144.*

Top Left Log (#5)

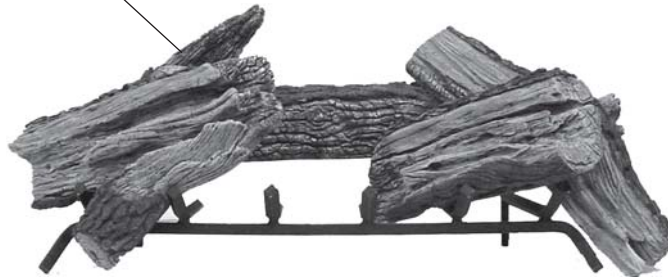

Figure 142 - Placing Top Left Log (#5) behind Rear Log

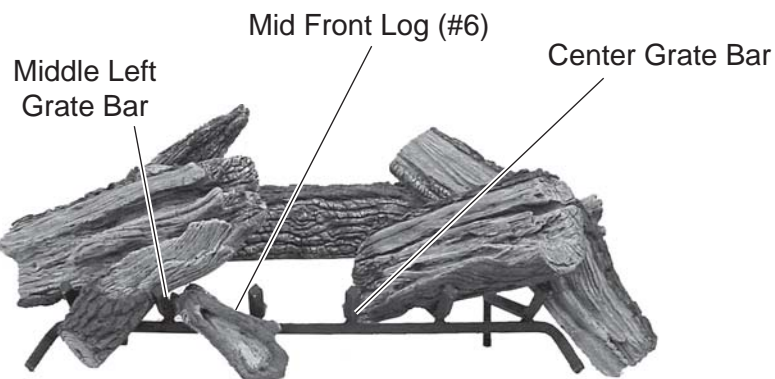

Figure 143 - Placing Mid Front Log (#6) on Grate Between Center and Middle Left Grate Bars.

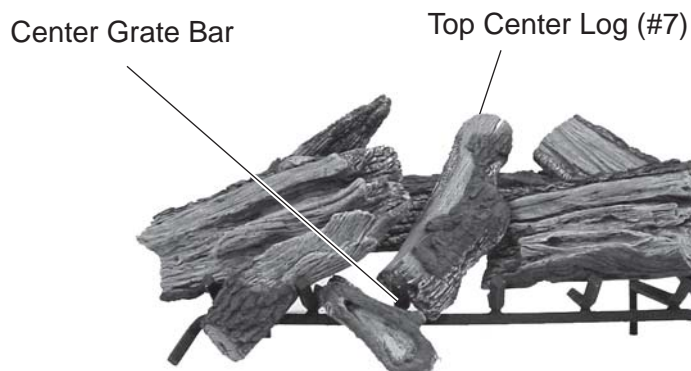

Figure 144 - Placing Top Center Log (#7) on Rear Log

OPERATING INSTRUCTIONS

SAFETY INSTRUCTION FOR MANUAL CONTROL (SPK)

FOR YOUR SAFETY READ BEFORE LIGHTING

WARNING

If you do not follow these instructions exactly, a fire or explosion may result causing property damage, personal injury or loss of life.

- A. BEFORE OPERATING smell all around the appliance area for gas. Be sure to smell next to the floor because some gas is heavier than air and will settle on the floor.

WHAT TO DO IF YOU SMELL GAS:

- Do not attempt to light any appliance.
 - Do not touch any electric switch; do not use any phone in your building.
 - Immediately call your gas supplier from a neighbor's phone. Follow the gas supplier's instructions.
 - If you cannot reach your gas supplier, call the fire department.
- B. Use only your hand to push in, or turn the gas control knob. Never use tools. If the knob will not push in or turn by hand, don't try to repair it. Call a qualified service technician. Force or attempted repair may result in a fire or explosion.
- C. Do not use this appliance if any part of it has been under water. Immediately call a qualified service technician to inspect the appliance and to replace any part of the control system and any gas control that has been under water.

MANUAL CONTROL LIGHTING INSTRUCTIONS

1. STOP! Read the safety information label.
2. Make sure the manual shutoff valve is fully open.
3. Push in gas control knob slightly and turn clockwise to "OFF."
NOTE: Knob cannot be turned to "OFF" unless knob is pushed in slightly.
4. Wait five (5) minutes to clear out any gas. Then smell for gas, including near the floor. If you smell gas, STOP! Follow "B" in the safety information label. If you don't smell gas, go to next step.
5. Find pilot — follow metal tube from gas control.
6. From "OFF" position, push in gas control knob slightly and turn counterclockwise to "PILOT." Push in control knob for 5 seconds.
7. With the control knob pushed in, immediately light the pilot with a match. Continue to hold the control knob in for about one (1) minute after the pilot is lit. Release knob and it will pop back up. Pilot should remain lit. If it goes out, repeat steps 5 through 9.
 - If knob does not pop up when released, stop and immediately call your service technician or gas supplier.
 - If the pilot will not stay lit after several tries, turn the gas control knob to off and call your service technician or gas supplier.
8. Turn gas control knob counterclockwise to "ON."



Figure 145 - Control Knob

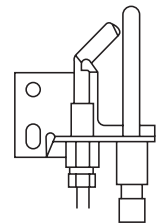





Figure 146 - Manual Pilot

TO TURN OFF GAS TO HEATER

1. Push in gas control knob slightly and turn clockwise to OFF position. Do not force.

MILLI-VOLT CONTROL LIGHTING INSTRUCTIONS

1. STOP! Read the safety information label.
2. Make sure the manual shutoff valve is fully open.
3. Turn gas control knob clockwise  to the "OFF" position, and turn ON/OFF switch to "OFF" position.
4. Wait (5) minutes to clear out any gas. Then smell for gas, including near the floor. If you smell gas, STOP!
5. From "OFF" position, turn the gas control knob counterclockwise  to "PILOT" position. Push in control knob for 5 seconds.
6. With the control knob pushed in, light pilot with match.
7. Continue pushing the control knob in for a further 60 seconds to prevent the flame detector from shutting off the gas while the probe is warming up. Release the control knob.
8. Turn gas control knob counterclockwise  to the "ON" position.
9. After the pilot has been lit for one minute, the burners can be turned on. Turn the ON/OFF switch to "ON" position.
10. If the gas logs will not operate, follow the instructions "To Turn Off Gas to Heater" and call your service technician or gas supplier.

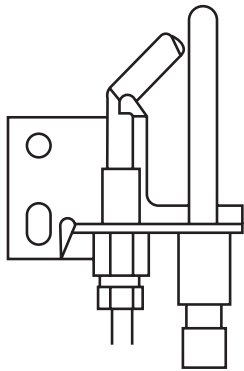

Figure 147 - Pilot

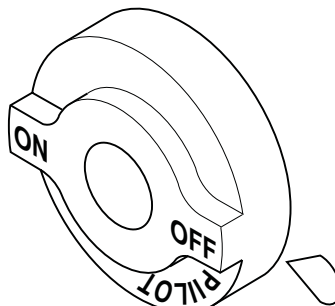

Figure 148 - Control Knob

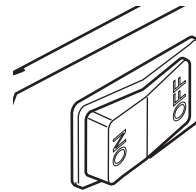



Figure 149 - On/Off Switch

TO TURN OFF GAS TO HEATER

1. Turn control knob clockwise  to OFF position to completely shut off the heater.
2. If applicable: Turn ON/OFF switch to OFF position.

FLAME APPEARANCE

CHECKING BURNER FLAMES

Flame should be yellow and extend vertically (not curling toward fireplace screen).

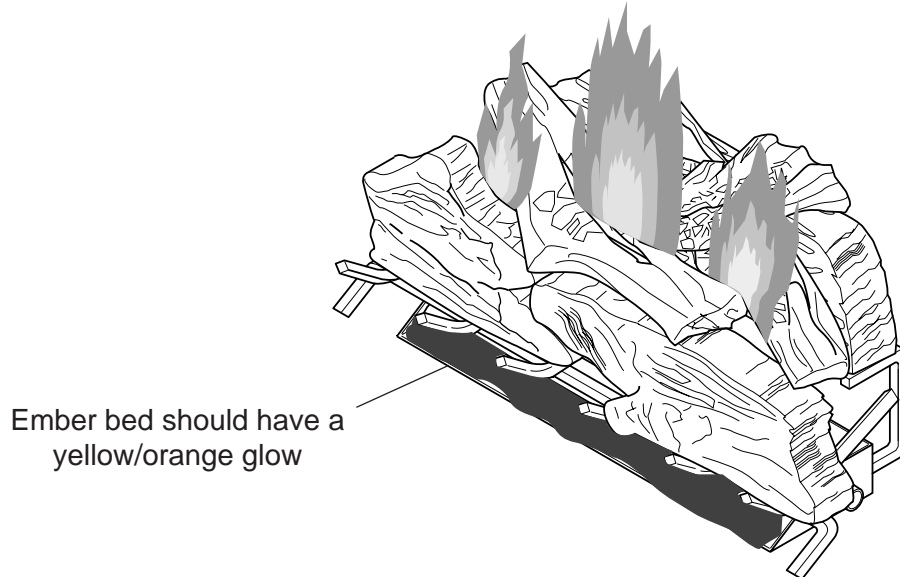

Figure 150 - Flame Appearance

PILOT FLAME APPEARANCE

The pilot flame must always be present when appliance is operating. It should just touch the top of the thermocouple/thermopile tip.

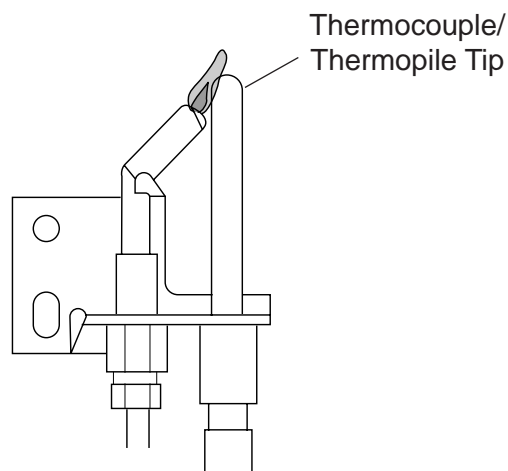

Figure 151 - Pilot Flame Appearance

During manufacturing, fabricating, and shipping, various components of this appliance are treated with certain oils, films, or bonding agents. These chemicals are not harmful, but may produce annoying smoke and smells as they burn off the first time the appliance is used. Operate the appliance 2 to 3 hours at the highest setting to burn off all the oils, films, etc. Never use this appliance with glass doors closed. This could cause the pilot to go out and cause severe sooting outside the fireplace. Always operate this appliance with the fireplace screens in place.

IMPORTANT: Fireplace Draft Test During Initial Installation

It is critical to verify that your chimney is drafting properly because the fireplace and gas logs function as a system.

Although MHS, Inc. goes to great lengths to design vented gas log sets that minimize sooting, all vented log sets will soot over time. Sooting normally appears as areas of black powder-like substance on the logs. It is important to periodically clean and inspect the logs per the cleaning and servicing.

WARNING

Fireplace systems that do not draft properly can increase the amount of soot produced by normal operation of the log set and, in extreme cases, can cause soot to be deposited within the room. This effect can be a sign of a blocked chimney, a faulty vent system or the result of negative pressure within the home. The dealer should be able to diagnose if a problem exists and be able to provide a solution to improve the venting of the fireplace.

FIREPLACE DRAFT TEST METHOD

To determine if your fireplace is drafting properly, turn the log set on. After log set has been burning for about 10 minutes, place a match or smoke stick along the top and sides of the fireplace opening. If the flame or smoke is not pulled into the fireplace, then ***the fireplace is not venting properly***. At this point, the damper stop should be adjusted so that the damper opening is increased. If the problem remains after the open area of the damper is increased, then the fireplace system should be professionally inspected to determine if your firebox/chimney is venting properly.

REMOTE CONTROL RECEIVER REPLACEMENT

The remote control receiver and batteries are very sensitive to heat. Exposure to high temperatures can cause the receiver to malfunction and shorten the life of the batteries. If your fireplace does NOT have a restrictive barrier (see page 6), such as glass doors, it is recommended that the remote receiver be affixed to the right hand side of the heat shield or placed in the front, right corner of the fireplace. If your fireplace has a restrictive barrier, it is recommended that the remote receiver be placed outside of the fireplace.

CLEANING AND SERVICING

WARNING

Turn off gas logs and allow to cool before cleaning. Disconnect electrical power if applicable before cleaning or servicing.



Figure 152 - Removing Soot with a Soft Bristle Brush

The log set should be cleaned at least once a year for maximum performance.

Turn gas supply off. Allow unit to cool. Remove logs, handling carefully by holding gently at each end. Gloves are recommended when handling the log to prevent skin irritation from ceramic fibers. If skin becomes irritated, wash gently with soap and water. Refer to manual for correct log placement. Brush each log gently with a soft bristle brush. This will remove soot that has built up on the log set. **DO NOT USE LIQUID SOOT REMOVER ON LOGS!**

To refurbish the grate, remove grate and take it outside. Use a wire brush or sandpaper to remove any discoloration to the grate. Paint grate with high temperature black paint (barbecue paint). Reinstall grate after paint dries.

If embers (rock wool) have turned a rust color and become brittle, remove old embers (rock wool) from log set. Replace with new rock wool. Rock wool can be purchased from you local dealer. See log placement section for placement of embers.

ASSEMBLY

Item	Description	VWF (18,24,30,36) NM	VWF (18,24,30,36) PM	VWF (18,24,30,36) NV	VWF (18,24,30,36) PV
1	Injector	27D7022	27D0406	27D7022	27D0406
2	Manual Control Valve	27D8951	27D8951	—	—
3	Milli-volt Control Valve	—	—	27D8006	27D8005
4	Manual Shaft Extender (2 Required)	27D0410	27D0410	—	—
5	Control Knob	27D0602	27D0602	—	—
6	Regulator	24D0305	24D0306	—	—
7	Switch	—	—	32D0232	32D0232
8	Pilot	27D0301	27D0302	27D7027	27D7028

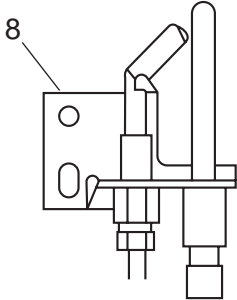
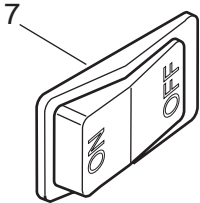
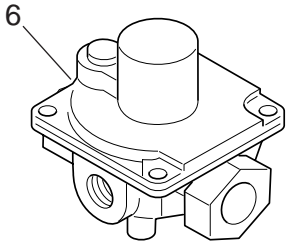
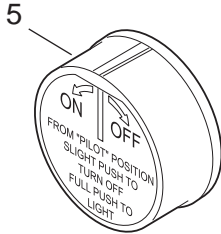
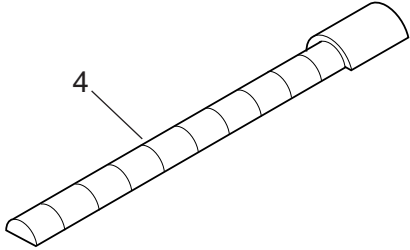
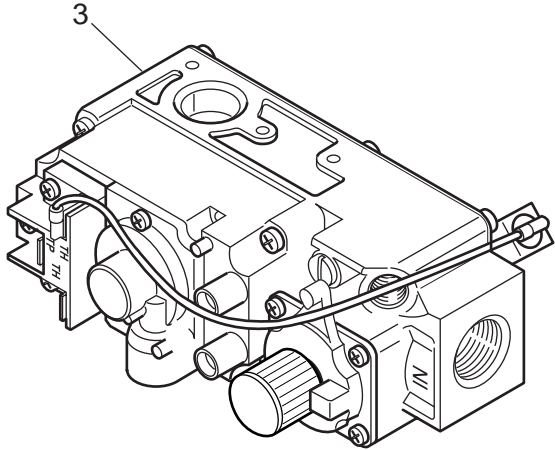
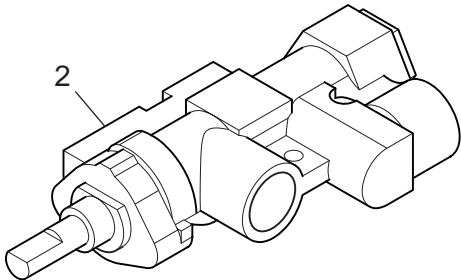
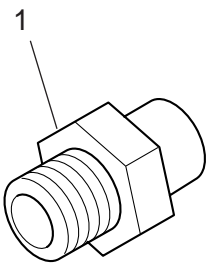

MASSIVE OAK LOGS

Item	Description	Qty.	VWF18MO	VWF24MO	VWF30MO
1	Back Log	1	27D7500	27D7506	27D7510
2	Left Front Log	1	27D7501	27D7507	27D7511
3	Right Front Log	1	27D7502	27D7508	27D7512
4	Left Side Middle Log	1	27D7503	27D7503	27D7503
5	Right Side Middle Log	1	27D7504	27D7504	27D7504
6	Right Top Log	1	27D8826	27D8826	27D8826
7	Left Top Log	1	—	27D7509	27D7509
8	Top Crossover Log	1	—	—	27D7513

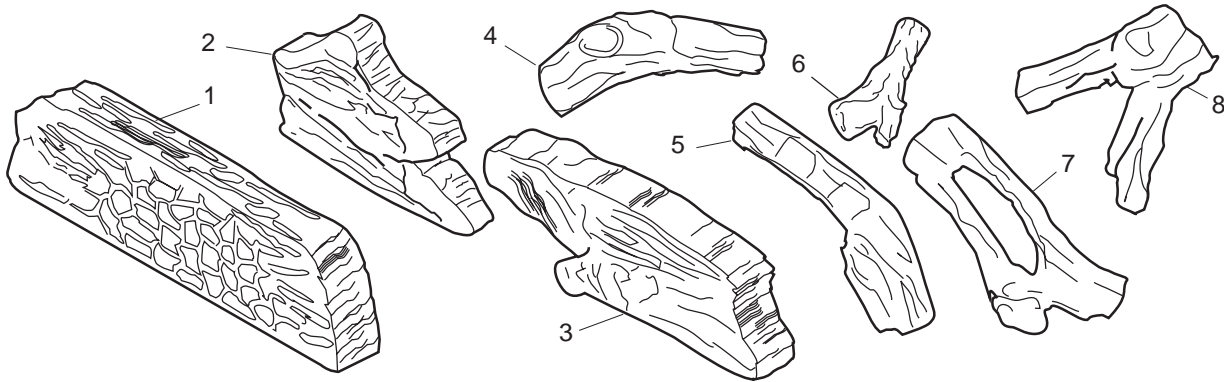

Item	Description	Qty.	VWF36MO
1	Rear Log	1	27D8824
2	Left Front Log	1	27D7511
3	Center Front Log	1	27D8825
4	Right Front Log	1	27D7512
5	Left Side Log	1	27D7503
6	Right Side Log	1	27D7504
7	Right Side Middle Log	1	27D7509
8	Top Log	1	27D8599
9	Top Log	1	27D8581
10	Top Log	1	27D8586
11	Top Left Log	1	27D8826

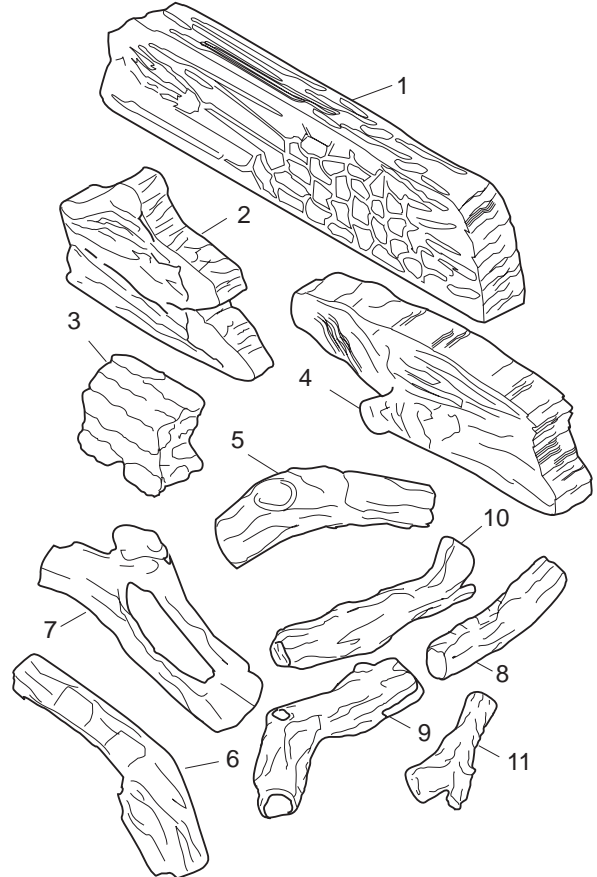

REPLACEMENT PARTS

AMERICAN OAK LOGS

Item	Description	Qty.	VWF18AO	VWF24AO	VWF30AO
1	Front Log	1	27D8576	27D8584	27D8592
2	Back Log	1	27D8577	27D8585	27D8593
3	Right Middle Log	1	—	27D8588	—
4	Left Middle Log	2	27D8580	27D8580	27D8580
5	Top Right Log	2	—	—	27D8594
6	Top Left Log	1	—	27D8587	—
7	Top Center Log	2-1	27D8578 (2)	—	27D8578 (1)
8	Top Top Center Log	1	—	—	27D8600

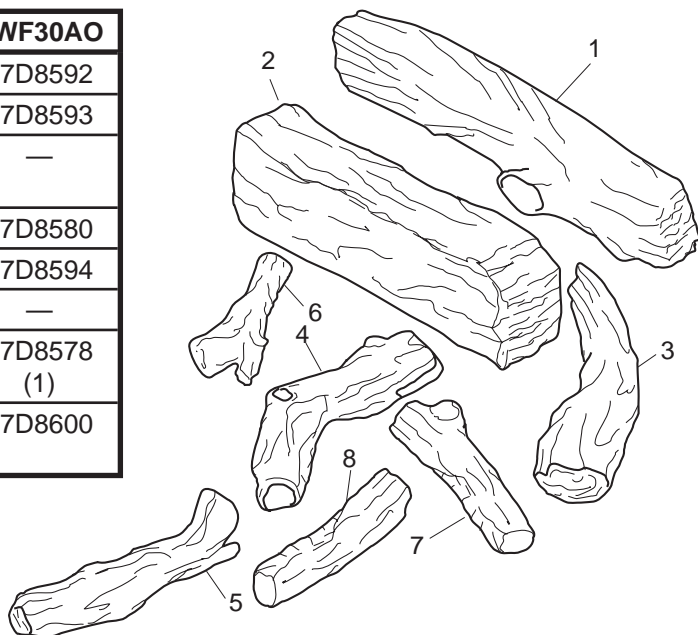

BIRCH LOGS

Item	Description	Qty.	VWF24B
1	Back Log	1	27D1026
2	MiddleLog	1	27D1025
3	Right Front Log	1	27D1024
4	Left Front Log	1	27D1023
5	Top Right Log	1	27D1028
6	Top Left Log	1	27D1027

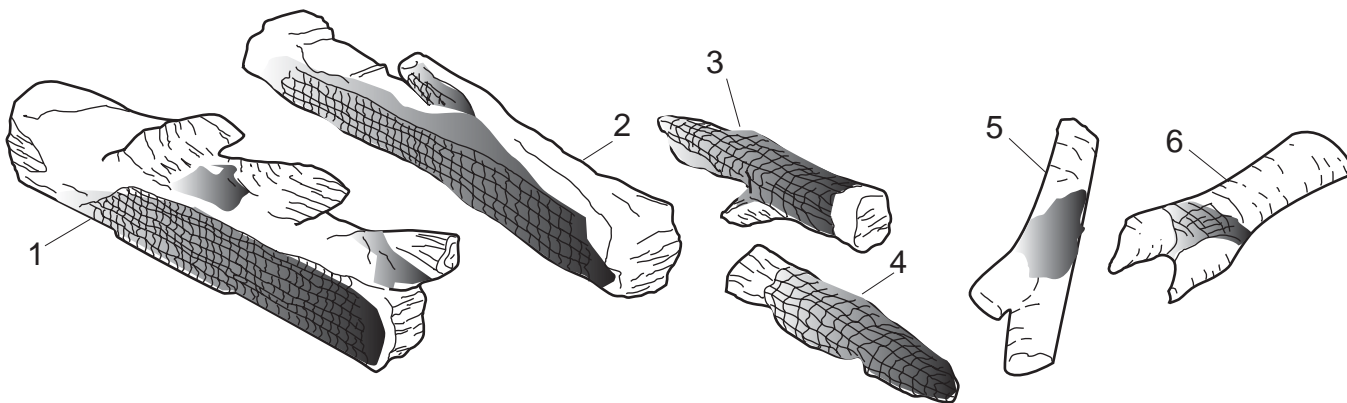

SPLIT RIVER OAK LOGS

Item	Description	Qty.	VWF24/18SRO	VWF30/24SRO	VWF36/30SRO
1	Front Log	1	27D8800	27D8807	27D8814
2	Bottom Left Log	1	27D8801	27D8808	27D8815
3	Bottom Right Log	1	27D8802	27D8809	27D8816
4	Top Right Log	1	27D8803	27D8810	27D8817
5	Bottom Front Left Log	1	27D8804	27D8811	27D8818
6	Top Left Log	1	27D8805	27D8812	27D8812
7	Center Top Log	1	27D8806	27D8813	27D8820
8	Front Right Log	1	—	—	27D8821

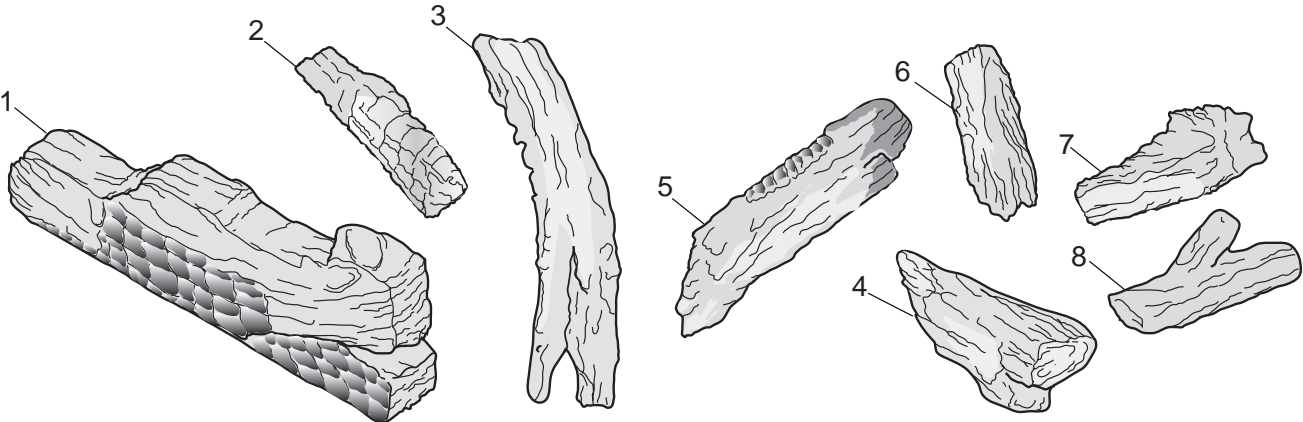

REPLACEMENT PARTS

SPLIT PINE LOGS

Item	Description	Qty.	VWF18SPA	VWF24SPA	VWF30SPA
1A	Front Left Log	1	27D8700	27D8702	27D8704
1B	Right Front Log	1	27D8701	27D8703	27D8705
2	Side Support Log	1	27D8551	27D8551	27D8567
3	Rear Log	1	27D8552	27D8560	27D8568
4	Right Log	1	—	27D8561	27D8569
5	Right Middle Log	1	27D8554	27D8562	27D8570
6	Left Log	1	27D8555	27D8555	27D8571
7	Top Center Log	1	27D8556	27D8556	27D8561
8	Top Left Log	1	27D8565	27D8565	27D8573
9	Top Top Left Log	1	—	—	27D8555

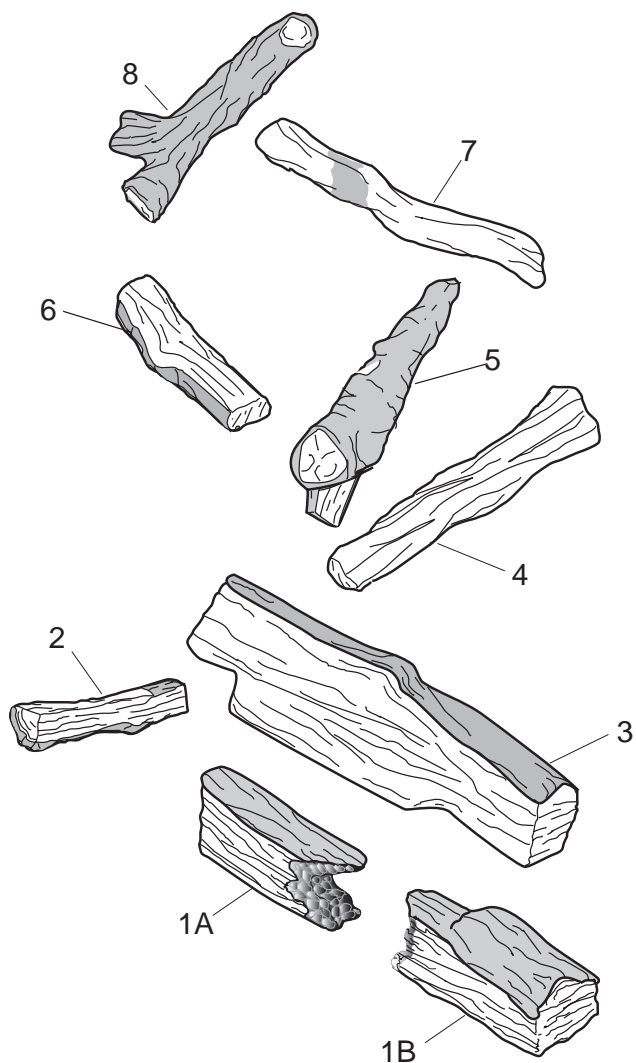

VWF18SPA AND VWF24SPA

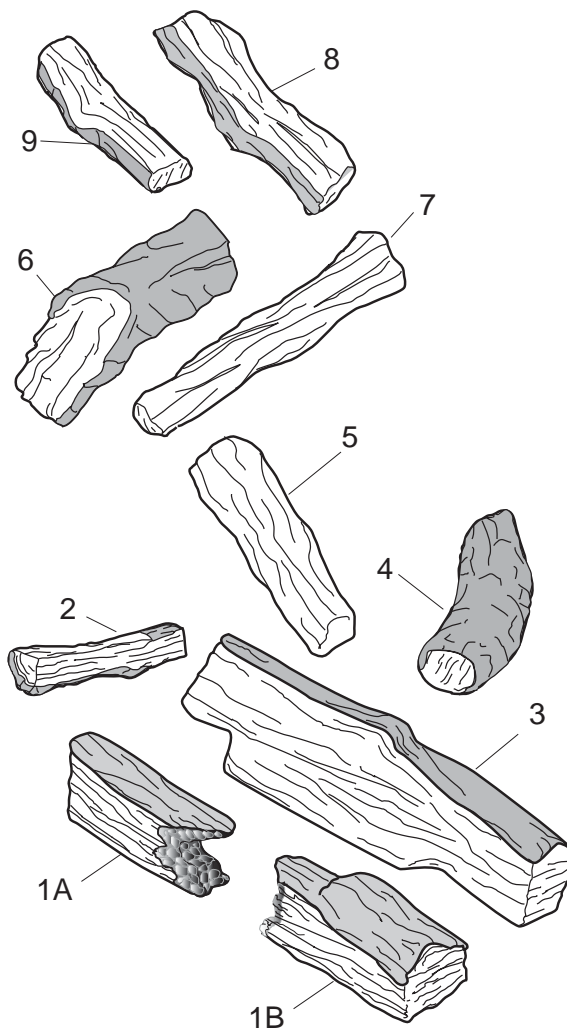

VWF30SPA

WEATHERED PINE LOGS

Item	Description	Qty	VWF24/18WP
1	Rear Log	1	27D5140
2	Bottom Right Log	1	27D5141
3	Bottom Left Log	1	27D5142
4	Top Right Log	1	27D5143
5	Top Left Log	1	27D5144
6	Mid Front Log	1	27D5145

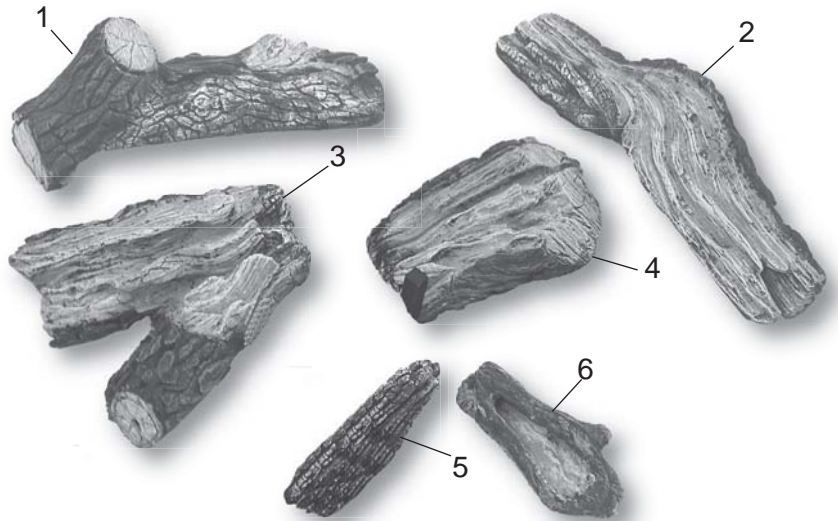

WEATHERED PINE LOGS

Item	Description	Qty	VWF30/24WP
1	Rear Log	1	27D5146
2	Bottom Right Log	1	27D5147
3	Bottom Left Log	1	27D5148
4	Top Right Log	1	27D5149
5	Top Left Log	1	27D5150
6	Mid Front Log	1	27D5145
7	Top Center Log	1	27D5151

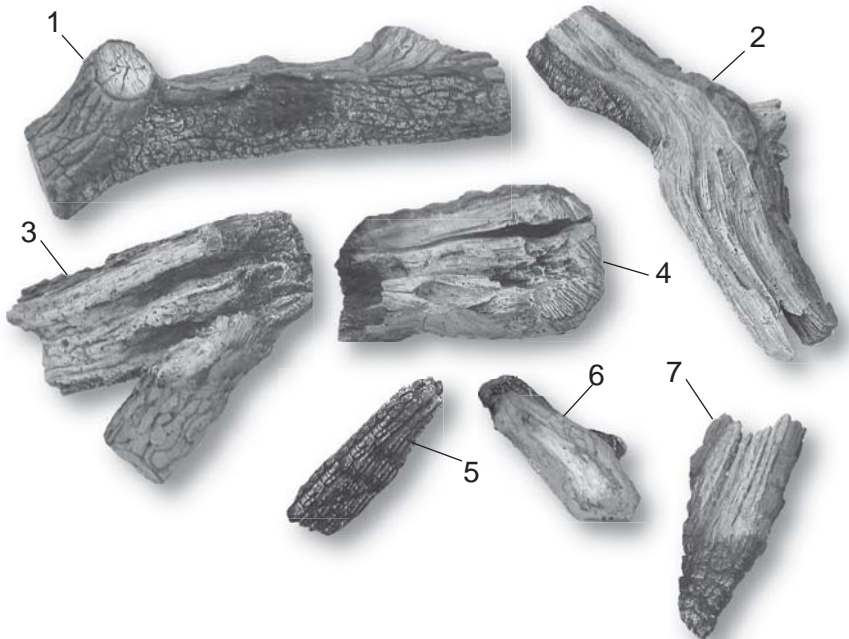

WEATHERED PINE LOGS

Item	Description	Qty	VWF36/30WP
1	Rear Log	1	27D5152
2	Bottom Right Log	1	27D5153
3	Bottom Left Log	1	27D5154
4	Top Right Log	1	27D5155
5	Top Left Log	1	27D5156
6	Mid Front Log	1	27D5145
7	Top Center Log	1	27D5157

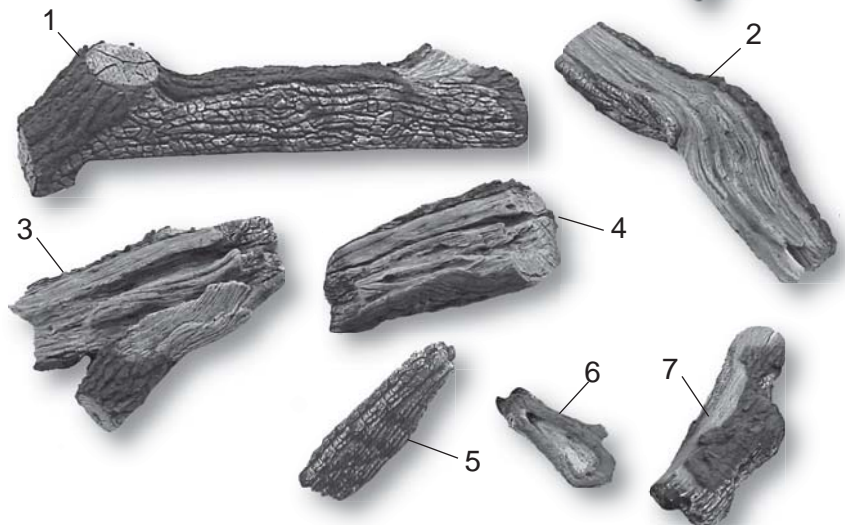

MASSACHUSETTS RESIDENTS ONLY: PLEASE READ AND FOLLOW THESE SPECIAL REQUIREMENTS

NOTE REGARDING VENTED PRODUCTS

This product must be installed by a licensed plumber or gas fitter when installed within the Commonwealth of Massachusetts.

Any residence with a direct vent product must have a CO detector installed in the residence.

Installation of the fireplace or vented gas log in the State of Massachusetts requires the damper to be permanently removed or welded in the fully open position.

In addition, a naturally vented gas log may not be installed in a bedroom or bathroom in the State of Massachusetts.

Flex line installation must not exceed 36 inches and must have a T shutoff valve.

NOTE REGARDING VENT FREE PRODUCTS

This product must be installed by a licensed plumber or gas fitter when installed within the Commonwealth of Massachusetts.

In addition, vent free products may not be installed in a bedroom or bathroom regardless of size or type in the State of Massachusetts.

Flex line installation must not exceed 36 inches and must have a T shutoff valve.

CARBON MONOXIDE DETECTOR REQUIREMENTS

(2) Revise 10.8.3 by adding the following additional requirements:

(a) For all side wall horizontally vented gas fueled equipment installed in every dwelling, building or structure used in whole or in part for residential purposes, including those owned or operated by the Commonwealth and where the side wall exhaust vent termination is less than seven (7) feet above finished grade in the area of the venting, including but not limited to decks and porches, the following requirements shall be satisfied:

1. **INSTALLATION OF CARBON MONOXIDE DETECTORS.** At the time of installation of the side wall horizontal vented gas fueled equipment, the installing plumber or gasfitter shall observe that a hard wired carbon monoxide detector with an alarm and battery back-up is installed on the floor level where the gas equipment is to be installed. In addition, the installing plumber or gasfitter shall observe that a battery operated or hard wired carbon monoxide detector with an alarm is installed on each additional level of the dwelling, building or structure served by the side wall horizontal vented gas fueled equipment. It shall be the responsibility of the property owner to secure the services of qualified licensed professionals for the installation of hard wired carbon monoxide detectors
 - a. In the event that the side wall horizontally vented gas fueled equipment is installed in a crawl space or an attic, the hard wired carbon monoxide detector with alarm and battery back-up may be installed on the next adjacent floor level.
 - b. In the event that the requirements of this subdivision can not be met at the time of completion of installation, the owner shall have a period of thirty (30) days to comply with the above requirements; provided, however, that during said thirty (30) day period, a battery operated carbon monoxide detector with an alarm shall be installed.

SPECIAL REQUIREMENTS CONTINUED

2. **APPROVED CARBON MONOXIDE DETECTORS.** Each carbon monoxide detector as required in accordance with the above provisions shall comply with NFPA 720 and be ANSI/UL 2034 listed and IAS certified.
 3. **SIGNAGE.** A metal or plastic identification plate shall be permanently mounted to the exterior of the building at a minimum height of eight (8) feet above grade directly in line with the exhaust vent terminal for the horizontally vented gas fueled heating appliance or equipment. The sign shall read, in print size no less than one-half (1/2) inch in size, **“GAS VENT DIRECTLY BELOW. KEEP CLEAR OF ALL OBSTRUCTIONS.”**
 4. **INSPECTION.** The state or local gas inspector of the side wall horizontally vented gas fueled equipment shall not approve the installation unless, upon inspection, the inspector observes carbon monoxide detectors and signage installed in accordance with the provisions of 248 CMR 5.08(2)(a)1 through 4.
- (b) **EXEMPTIONS:** The following equipment is exempt from 248 CMR 5.08(2)(a)1 through 4:
1. The equipment listed in Chapter 10 entitled “Equipment Not Required To Be Vented” in the most current edition of NFPA 54 as adopted by the Board; and
 2. Product Approved side wall horizontally vented gas fueled equipment installed in a room or structure separate from the dwelling, building or structure used in whole or in part for residential purposes.
- (c) **MANUFACTURER REQUIREMENTS - GAS EQUIPMENT VENTING SYSTEM PROVIDED.** When the manufacturer of Product Approved side wall horizontally vented gas equipment provides a venting system design or venting system components with the equipment, the instructions provided by the manufacturer for installation of the equipment and the venting system shall include:
1. Detailed instructions for the installation of the venting system design or the venting system components; and
 2. A complete parts list for the venting system design or venting system.
- (d) **MANUFACTURER REQUIREMENTS - GAS EQUIPMENT VENTING SYSTEM NOT PROVIDED.** When the manufacturer of a Product Approved side wall horizontally vented gas fueled equipment does not provide the parts for venting the flue gases, but identifies “special venting systems,” the following requirements shall be satisfied by the manufacturer:
1. The identification of each “special venting system” shall include either the listing of the website, phone number or manufacturer's address where the venting system installation instructions can be obtained; and
 2. The “special venting systems” shall be Product Approved by the Board, and the instructions provided with that system shall include a parts list and detailed installation instructions.
- (e) A copy of all installation instructions for the Product Approved side wall horizontally vented gas fueled equipment and all the venting instructions, parts lists, and/or all design instructions for the venting system shall remain with the appliance or equipment at the completion of the installation.

LIMITED LIFETIME WARRANTY POLICY

LIFETIME WARRANTY

The following components are warranted for life to the original owner, subject to proof of purchase: Firebox, Combustion Chamber, Heat Exchanger, Grate, Stainless Steel Burners, and Vented Fiber Ceramic and Refractory Logs.

FIVE YEAR WARRANTY

The following components are warranted for 5 years to the original owner, subject of proof of purchase: Vent-free Ceramic Fiber Logs, Catalytic Filter and Aluminized Burners.

BASIC WARRANTY

MHS, inc. warrants the components and materials in your gas appliance to be free from manufacturing and material defects for a period of two years from date of installation. After installation, if any of the components manufactured by MHS in the appliance are found to be defective in materials or workmanship, MHS will, at its option, replace or repair the defective components at no charge to the original owner. MHS will also pay for reasonable labor costs incurred in replacing or repairing such components for a period of two years from the date of installation. Any products presented for warranty repair must be accompanied by a dated proof of purchase.

This Limited Warranty will be void if the appliance is not installed by a qualified installer in accordance with the installation instructions. The Limited Lifetime Warranty will also be void if the appliance is not operated and maintained according to the operating instructions supplied with the appliance, and does not extend to (1) firebox/burner assembly damage by accident, neglect, misuse, abuse, alteration, negligence of others, including the installation thereof by unqualified installers, (2) the costs of removal, reinstallation or transportation of defective parts on the appliance, or (3) incidental or consequential damage. All service work must be performed by an authorized service representative.

This warranty is expressly in lieu of other warranties, express or implied, including the warranty of merchantability of fitness for purpose and of all other obligations or liabilities. MHS, Inc. does not assume for it any other obligations or liability in connection with the sale or use of the appliance. In states that do not allow limitations on how long an implied warranty lasts, or do not allow exclusion of indirect damages, those limitations of exclusions may not apply to you. You may also have additional rights not covered in this Limited Warranty.

MHS reserves the right to investigate any and all claims against the Limited Warranty and decide upon method of settlement.

For information about this warranty, contact:

**Technical Services Department
Monessen Hearth Systems
149 Cleveland Drive
Paris, Kentucky 40361**