

This Owner's Manual is provided and hosted by [Appliance Factory Parts](#).

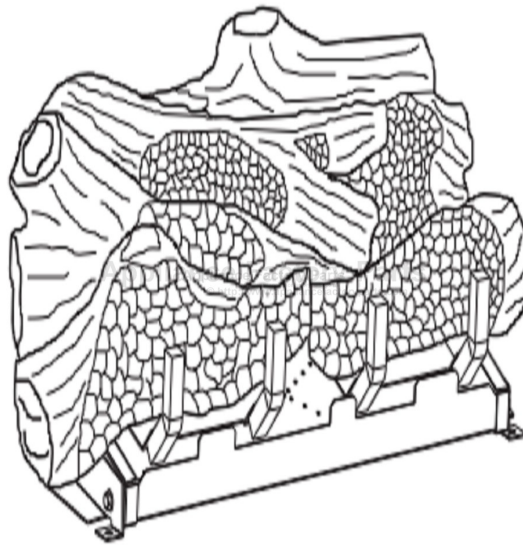

EMPIRE LS-18C2S-1 Owner's Manual

[Shop genuine replacement parts for EMPIRE
LS-18C2S-1](#)



[Find Your EMPIRE Other Parts - Select From 58 Models](#)

----- Manual continues below -----



INSTALLATION INSTRUCTIONS AND OWNER'S MANUAL

The *White Mountain* Log Collection **CHARRED OAK** **CHARRED OAK SUPER SIZE**

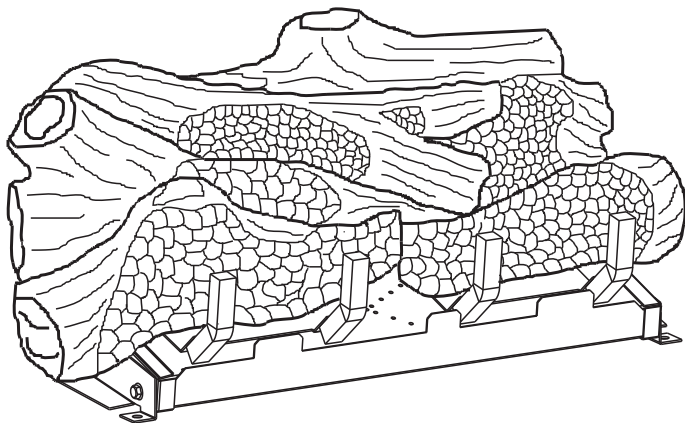

Installer: Leave this manual with the appliance.
Consumer: Retain this manual for future reference.

WARNING: If the information in these instructions are not followed exactly, a fire or explosion may result causing property damage, personal injury or loss of life.

- Do not store or use gasoline or other flammable vapors and liquids in the vicinity of this or any other appliance.
- **WHAT TO DO IF YOU SMELL GAS**
 - Do not try to light any appliance.
 - Do not touch any electrical switch; do not use any phone in your building.
 - Immediately call your gas supplier from a neighbor's phone. Follow the gas supplier's instructions.
 - If you cannot reach your gas supplier, call the fire department.
- Installation and service must be performed by a qualified installer, service agency or the gas supplier.

**LOG SET FOR UNVENTED
GAS LOG HEATER
OR
VENTED DECORATIVE APPLIANCE
MODELS**

**CHARRED OAK CHARRED OAK
 SUPER SIZE**

LS-16C-2

LS-18C2-1

LS-24C2-1

LS-30C2-1

LS-18C2S-1

LS-24C2S-1

LS-30C2S-1



We suggest that our gas hearth products be installed and serviced by professionals who are certified in the U.S. by the National Fireplace Institute® (NFI) as NFI Gas Specialists.

Log sets comply with ANSI Z21.11.2 Unvented Heaters and also comply with ANSI Z21.60 Decorative Vented Appliances for Solid Fuel Burning Fireplaces. State or local codes may only allow operation of log sets in a vented configuration. Check your state or local codes.

WARNING: If not installed, operated and maintained in accordance with the manufacturer's instructions, this product could expose you to substances in fuel or from fuel combustion which can cause death or serious illness.

The QR Codes below provide a link to our helpful "how-to" videos. To get started, scan the code with your smart phone or tablet.



Charred Oak Log Assembly



Charred Oak Super Size
Log Assembly

TABLE OF CONTENTS

Section	Page
Important Installation Guidelines	3
General Information	4
Requirements for Canada.....	5
LS-16C-2 Log Identification	6
LS-16C-2 Log Placement	7-12
Ember Placement LS-16C-2 Photos.....	13
LS-(18,24,30)C2 Log Identification	14
LS-(18,24,30)C2 Log Placement	15-20
Ember Placement LS-18C2 Photos.....	21
Ember Placement LS-24C2 Photos.....	22
Ember Placement LS-30C2 Photos.....	23
LS-18C2S Log Identification	24
LS-18C2S Log Placement	25-32
Ember Placement LS-18C2S Photos	33
LS-(24,30)C2S Log Identification.....	34
LS-(24,30)C2S Log Placement.....	35-42
Ember Placement LS-24C2S Photos	43
Ember Placement LS-30C2S Photos	44
Charred Oak Parts List and Parts View	45
Charred Oak Super Size Parts List and Parts View.....	46
Master Parts Distributor List.....	47
How to Order Repair Parts	47

IMPORTANT INSTALLATION GUIDELINES

Proper Log Placement

Log placement is critical to proper burner performance. Logs must be correctly positioned onto the burner. The photos in this manual show the proper pinned position for logs on this set. Owners need to be shown proper log placement and instructed not to move the logs.

Logs must fit firmly onto the burner when positioned as shown in the photos. Malformed logs or logs with sloppy pin holes must be replaced.

Proper Placement of Rock Wool and Decorative Lava Rock

Rock wool can be added to burners for a glowing ember effect. It must be positioned only on the front portion of the burner. The photos in this manual show the proper placement of rock wool.

Decorative lava rock or small wood pieces should never be placed on the burner. These items are only for placement on the floor of the fireplace or firebox.

Proper Primary Airflow into Burner

For proper burner operation and flame appearance, the flow of primary air into the venturi tube, located on the rear of the burner, must not be reduced. This flow of air is reduced if dirt, lint or other obstructions build-up around or inside the venturi. Any obstruction in the venturi tube area must be removed. The flow of air into the venturi is also reduced if the gas orifice isn't centered in the venturi inlet and/or is not aligned with the venturi. Any misalignment of the burner orifice may be corrected by bending the shutter cap holding the orifice to the inlet of the venturi tube.

Ceiling Fans, Portable Fans or Logs Installed Near Cold Air Returns

Ceiling fans or oscillating floor type fans need to be monitored during the operation of vent-free logs. If the air blows directly into the flame causing it to impinge on the log set, or firebox, it should be turned off or redirected. Ceiling fans could be reversed to possibly eliminate flame impingement, and the floor fan could be redirected. Upon installation, be aware of any cold air returns or vents in the proximity of the log set. Any draft created around a vent-free log set can cause the flame to impinge on the log and create a sooting situation.

WARNING: Do not allow fans to blow directly into the fireplace. Avoid any drafts that alter burner flame patterns.

WARNING: Do not use a blower insert, heat exchanger insert or other accessory not approved for use with this heater.

Candles

Avoid the use of scented or decorative candles while the log set is in operation. Candles produce a residue in the air that creates a soot like substance. Burning candles while the log set is operating magnifies the problem. It should be noted that candles, in general, produce soot. The amount of time burned and the quantity of candles burned will determine the amount of soot produced and deposited.

Make Owners Aware of Proper Log Set Operation

Properly installed and properly maintained log sets do not deposit soot on the logs. If users see soot appear on a log, call for service. Do not continue to operate the log set.

Sunken Fireplace

If installing this unit into a sunken fireplace, you must raise the floor to insure adequate airflow and guard against sooting. Raise fireplace floor using a non-combustible material, which is secure.

Glass Doors

Make sure that glass doors are open during all operations of the log set. The opening of the glass door frame should be the dimension used for the minimum front opening of the firebox.

Woodburning Fireplaces

The interior of the firebox and the chimney should be cleaned and free of all creosote before installing a gas burning log set. Creosote will soften when heated and can drop on the log set causing odors and possibly sooting.

WARNING: Before installing in a solid-fuel burning fireplace, the chimney flue and firebox must be cleaned of soot, creosote, ashes and loose paint by a qualified chimney cleaner.

GENERAL INFORMATION

Qualified Installing Agency

Installation and replacement of gas piping, gas utilization equipment or accessories and repair and servicing of equipment shall be performed only by a qualified agency. The term "qualified agency" means any individual, firm, corporation, or company that either in person or through a representative is engaged in and is responsible for (a) the installation, testing, or replacement of gas piping or (b) the connection, installation, testing, repair, or servicing of equipment; that is experienced in such work; that is familiar with all precautions required, and that has complied with all the requirements of the authority having jurisdiction.

The installation must conform with local codes or, in the absence of local codes, with the *National Fuel Gas Code, ANSI Z223.1/NFPA54*.*

*Available from the American National Standards Institute, Inc. 11 West 42nd St., New York, N.Y. 10018.

State of Massachusetts: The installation must be made by a licensed plumber or gas fitter in the Commonwealth of Massachusetts.

Sellers of unvented propane or natural gas-fired supplemental room heaters shall provide to each purchaser a copy of 527 CMR 30 upon sale of the unit.

In the State of Massachusetts, unvented propane and natural gas-fired space heaters shall be prohibited in bedrooms and bathrooms.

REQUIREMENTS FOR CANADA

This unit **cannot** be installed in a UNVENTED application, this unit **can only** be installed as a VENTED application with these requirements.

IMPORTANT SAFETY INFORMATION

This unit complies with ANSI Z21.60 and CGA 2.26 Decorative Gas Appliances For Installation In Solid Fuel Burning Fireplaces. Do not burn wood or solid fuels in a fireplace where a decorative gas log set is installed. This appliance is for installation only in a solid fuel burning fireplace, masonry fireplace or manufactured fireplace.









Warning: Any modification to this gas log set or to controls can be dangerous. Improper installation or use of the gas log set can cause serious injury or death from fire, burns, explosion or carbon monoxide poisoning.

1. Please follow all local codes regarding installation, combustion and ventilation air or in the absence of local codes follow the National Fuel Gas Code ANSI Z223.1 (U.S. installation), or CAN/CGA-B149, Installation Code (Canada installation).
2. Proper installation, burner pan location and log placement is important to achieve optimum look and performance of your gas log set. The logs have been designed for easy location and placement on the grate and must be followed for proper operation.
3. Do not operate this log set with glass doors in the closed position. A fireplace screen must be in place when the log set is burning. Adequate combustion air must be provided for proper venting. All flames should go up and out the top of the firebox into the flue vent. If any flames float or curl forward into the room do not operate appliance. Check for an open flue and adequate combustion air into the room. A damper clamp must be installed on the firebox damper to maintain an open flue vent condition. Refer to fireplace owners manual INSTALLING DAMPER CLAMP section.
4. Young children must be carefully supervised when they are in the same room as the gas log while in operation. Do not place stockings, clothing or any flammable material above or near the fireplace.
5. Do not substitute or use materials other than those supplied for use with the log set.
6. Also refer to IMPORTANT SAFETY INFORMATION in the fireplace Owner's Manual.

WARNING; DO NOT OPERATE THIS GAS LOG SET WITH GLASS DOORS CLOSED

- Clothing or other flammable material should not be placed on or near the appliance.
- Do not place trash or other articles on the log set during operation.
- During manufacturing, fabricating and shipping, various components of this appliance are treated with certain oils, films or bonding agents. These bonding agents are not harmful but may produce annoying smoke and smells as they are burned off during initial operation of the appliance. This is a normal temporary occurrence. A window should be opened during the initial bake out period.
- Keep burner and control compartment clean.
- **WARNING:** Before installing in a solid fuel burning fireplace, the chimney flue and firebox must be cleaned of soot, creosote, ashes and loose paint by a qualified chimney cleaner.
- Installation and repair should be done by a qualified service person. The appliance should be inspected before use and at least annually by a qualified service person. More frequent cleaning may be required due to excessive lint from carpeting, bedding materials, etc. It is imperative that control compartments, burners and circulating air passageways of the appliance be kept clean.
- **Do not** put anything around the fireplace that will obstruct the flow of ventilation air.
- **Do** keep the appliance area clear and free from combustible material, gasoline and other flammable vapors and liquids.
- A yearly examination and cleaning of the venting system of the solid-fuel burning fireplace must be performed by a qualified agency.
- **Do** make a periodic visual check of pilot and burners. Clean and replace damaged parts.
- **Do not** use this appliance if any part has been under water. Immediately call a qualified service technician to inspect the appliance and to replace any part of the control system and any gas control which has been under water.
- Never burn solid fuels in fireplace where a gas log set is installed.
- This unit complies with ANSI Z21.60 Decorative Vented Appliances for Solid Fuel Burning Fireplaces. State or local codes may only allow operation of this appliance in a vented configuration. Check your state or local codes.

LS-16C-2 LOG IDENTIFICATION

Log Description	Part Number	Front View	Top View
Log A	R7468		
Log B	R7467		
Log C	R7465		
Log D	R7466		

LS-16C-2 LOG PLACEMENT

Before you begin: Do not, handle these logs with your bare hands! Always wear gloves to prevent skin irritation. After handling logs, wash your hands gently with soap and water.

All Logs

The positioning of the logs is critical to the safe and clean operation of this heater. Sooting and other problems may result if the logs are not properly and firmly positioned in the appliance.

The following WARNING applies when log set is installed onto an unvented gas burner assembly.

WARNING

This appliance is equipped for (natural or propane) gas. Field conversion is not permitted.

Attention: Do not use Figure 1 to order replacement logs. Refer to Page 45 Parts List and Parts View to order logs for your appropriate model number.

WARNING

All previously applied loose material must be removed prior to reapplication.

Note: For step by step log placement instructions with images, see pages 8-12.

WARNING

Failure to position the parts in accordance with this diagram or failure to use only parts specifically approved with this appliance may result in property damage or personal injury

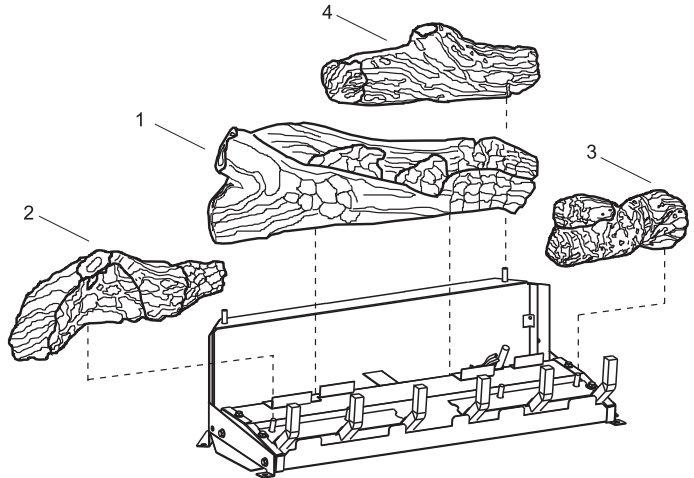

Log Placement LS-16C-2 and CHBR

Figure 1

Apply loose material (glowing embers) per appropriate Installation Instructions and Owner's Manual. Replacement of loose material (glowing embers) must be purchased from Empire Comfort Systems, Inc. Application of excess loose material (glowing embers) may adversely affect performance of the heater.

Replacement Loose Material (glowing embers)	Part Number
LS-16C and CHBR	15998
Platinum Bright Embers	PE-20-1

Note: A single layer of embers is to be used when applying Platinum Bright Embers (alone or in combination with production embers) to the burner.

Scan this code to see the log assembly video.



LS-16C-2 LOG PLACEMENT

1. Place Log A (#4) onto right, rear log support pin as shown below.

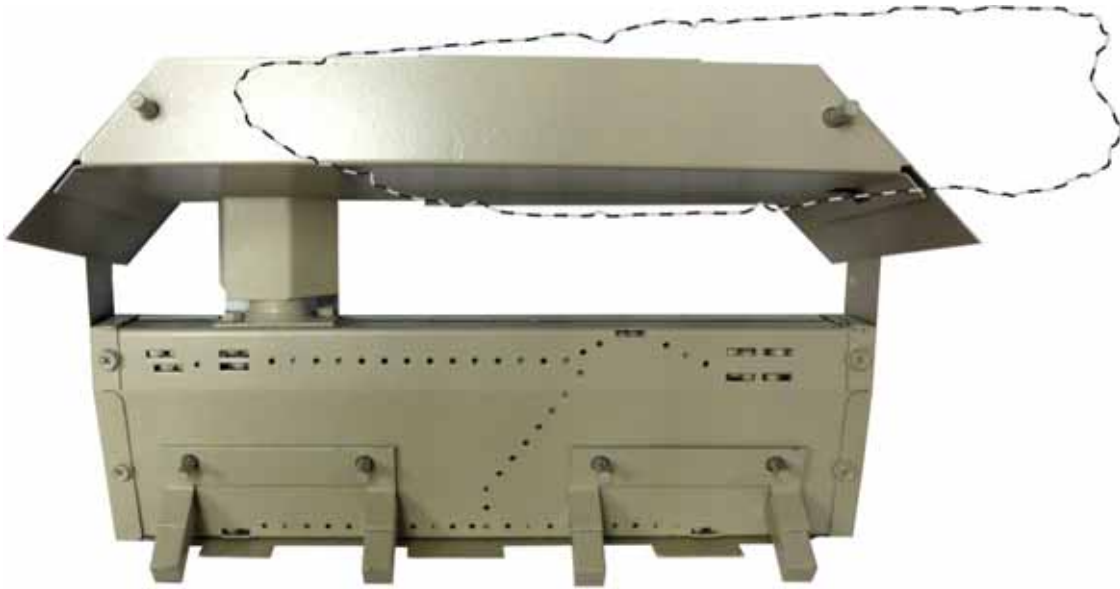

TOP VIEW

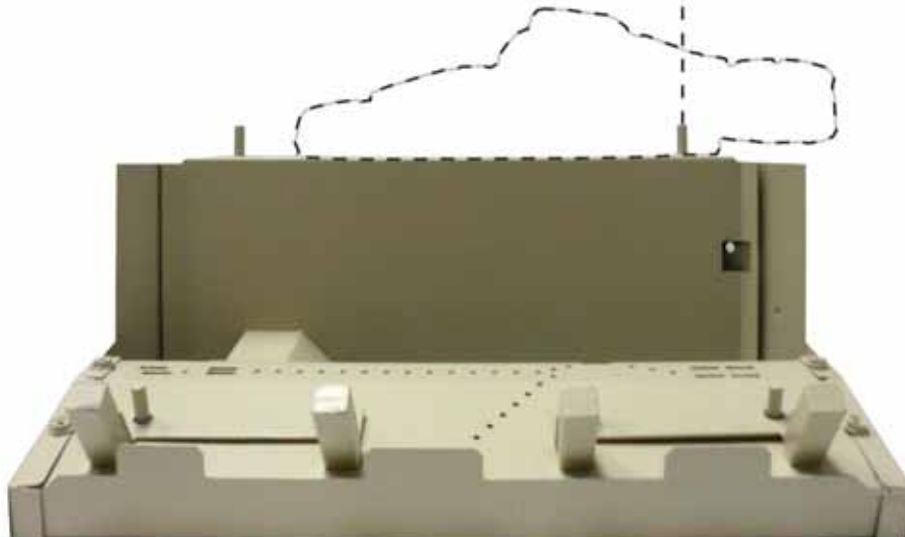

FRONT VIEW

LS-16C-2 LOG PLACEMENT

- Place Log B (#1) between rear log support and burner as shown below..



TOP VIEW



FRONT VIEW

LS-16C-2 LOG PLACEMENT

3. Place Log C (#2) onto two front left burner pins as shown below

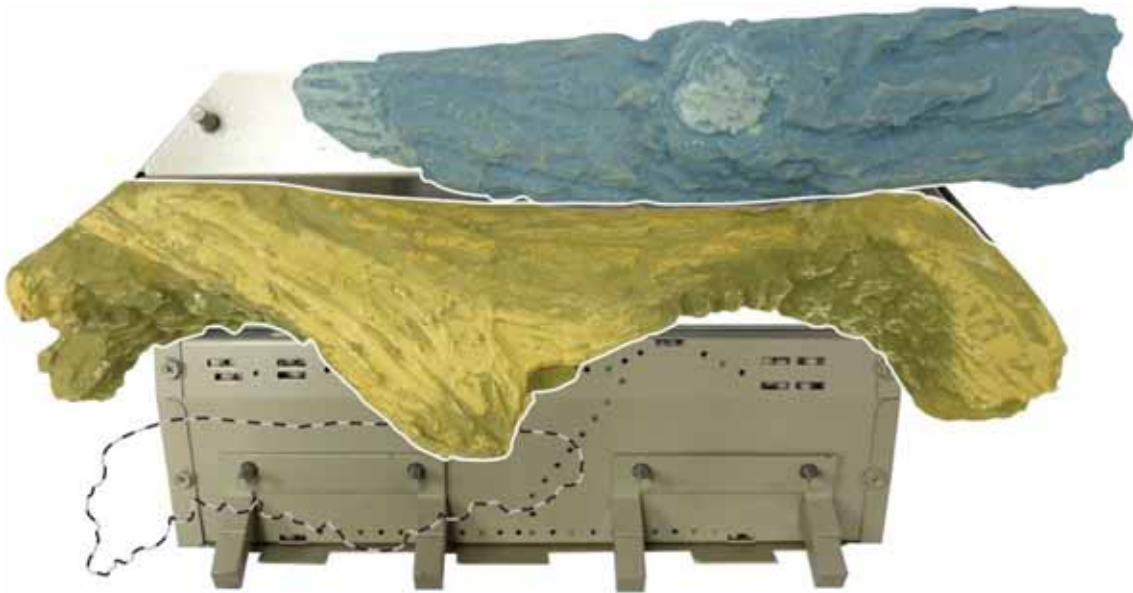

TOP VIEW



FRONT VIEW

LS-16C-2 LOG PLACEMENT

- Place Log D(#3) onto two front right burner pins as shown below.

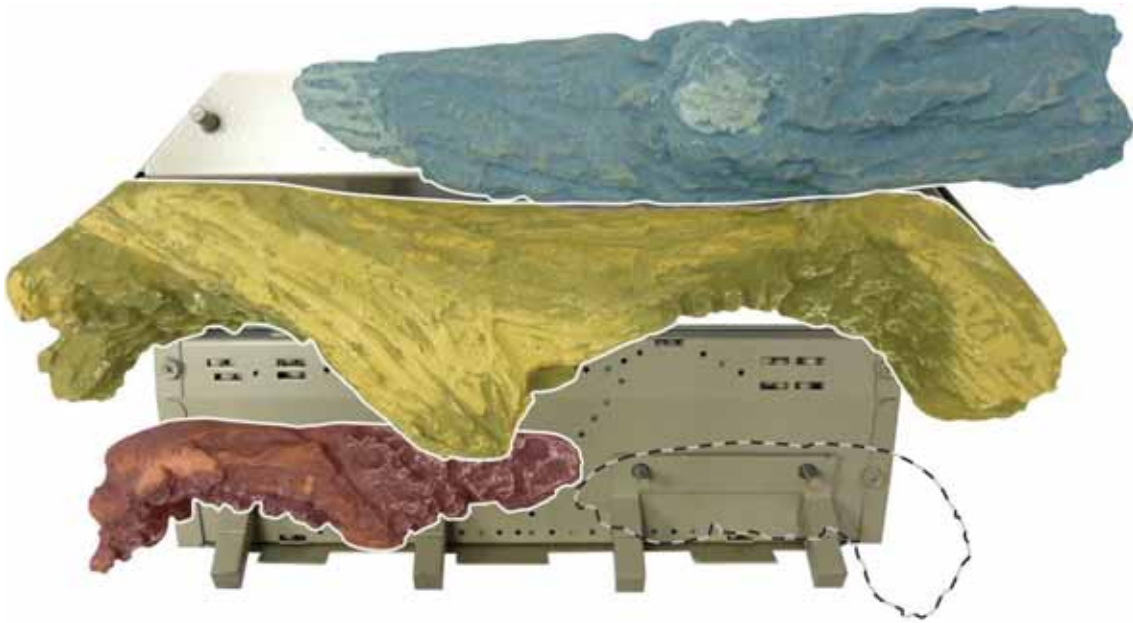

TOP VIEW

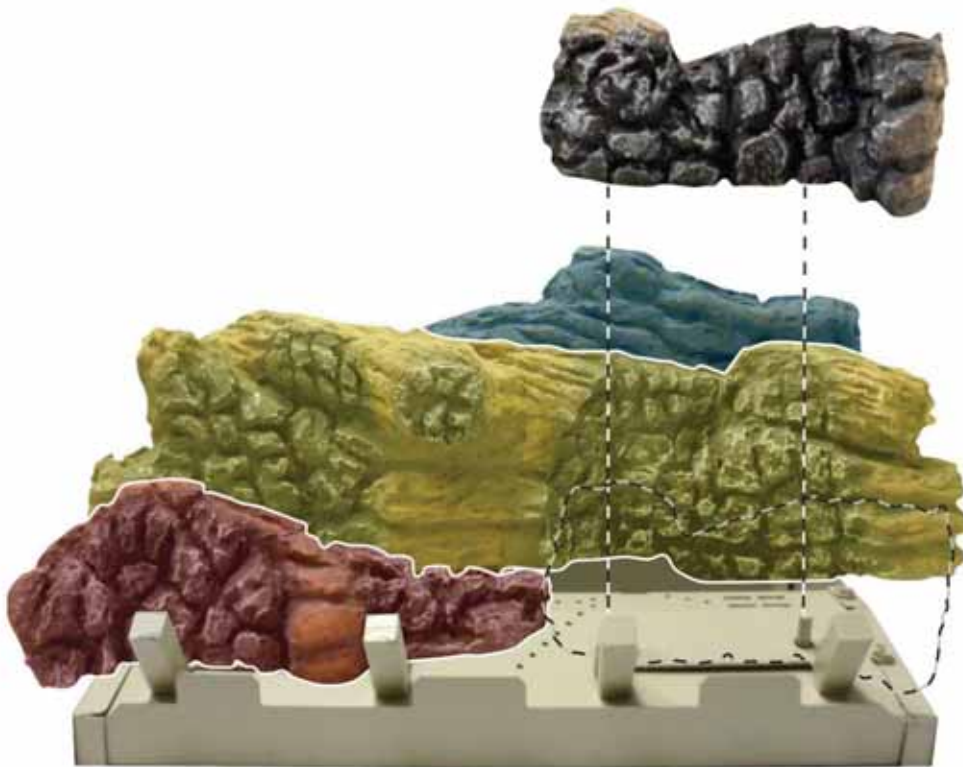

FRONT VIEW

LS-16C-2 LOG PLACEMENT

5. Log assembly is complete.

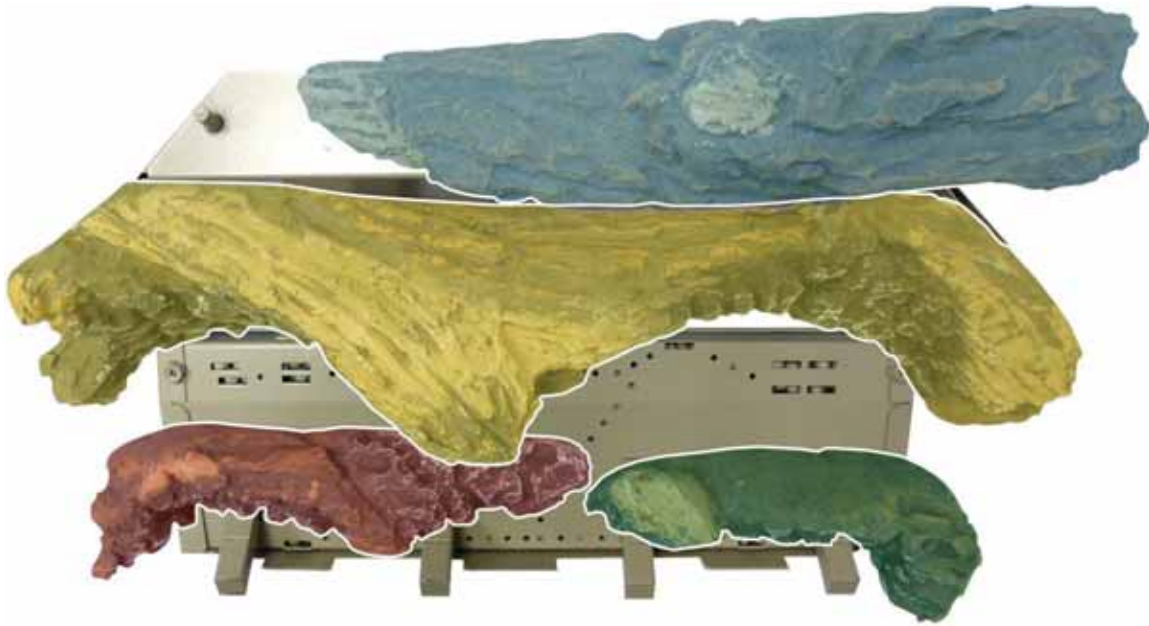

TOP VIEW



FRONT VIEW

EMBER PLACEMENT LS-16C-2 AND CHBR PHOTOS

Do not cover any large rear ports with loose material (glowing embers).

Photo 2

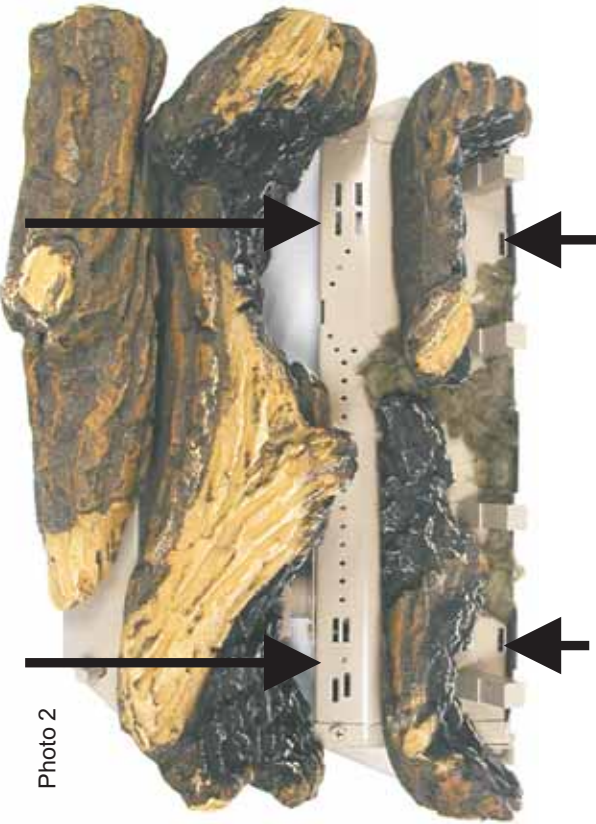

Do not cover any large front ports with loose material (glowing embers)

Photo 4



Photo 1



Photo 3



LS-(18,24,30)C2 LOG IDENTIFICATION

Log Description	Part Number			Front View	Top View
	LS-18C2	LS-24C2	LS-30C2		
Log A	R8301	R8306	R8310		
Log B	R8299	R8304	R8308		
Log C	R8300	R8305	R8309		
Log D	R8302	R8307	R8311		

LS-(18,24,30)C2 LOG PLACEMENT

Before you begin: Do not, handle these logs with your bare hands! Always wear gloves to prevent skin irritation. After handling logs, wash your hands gently with soap and water.

All Logs

The positioning of the logs is critical to the safe and clean operation of this heater. Sooting and other problems may result if the logs are not properly and firmly positioned in the appliance.

The following WARNING applies when log set is installed onto an unvented gas burner assembly.

⚠ WARNING

This appliance is equipped for (natural or propane) gas. Field conversion is not permitted.

Attention: Do not use Figure 2 to order replacement logs. Refer to Page 45 Parts List and Parts View to order logs for your appropriate model number.

⚠ WARNING

All previously applied loose material must be removed prior to reapplication.

Note: For step by step log placement instructions with images, see pages 15-19.

⚠ WARNING

Failure to position the parts in accordance with this diagram or failure to use only parts specifically approved with this appliance may result in property damage or personal injury

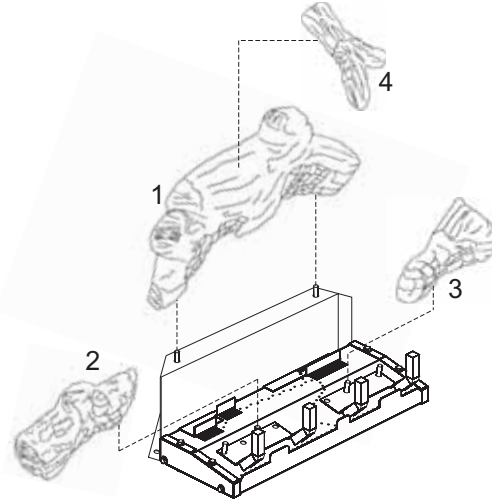

**Log Placement LS-(18,24,30)C2-1
Figure 2**

Apply loose material (glowing embers) per appropriate Installation Instructions and Owner's Manual. Replacement of loose material (glowing embers) must be purchased from Empire Comfort Systems, Inc. Application of excess loose material (glowing embers) may adversely affect performance of the heater.

Replacement Loose Material (glowing embers)	Part Number
LS-18C	15999
LS-24C	15970
LS-30C	15970
Platinum Bright Embers	PE-20-1

Note: A single layer of embers is to be used when applying Platinum Bright Embers (alone or in combination with production embers) to the burner.

Scan this code to see the log assembly video.



LS-(18,24,30)C2 LOG PLACEMENT

1. Place Log A (#1) onto rear log support pins as shown below.

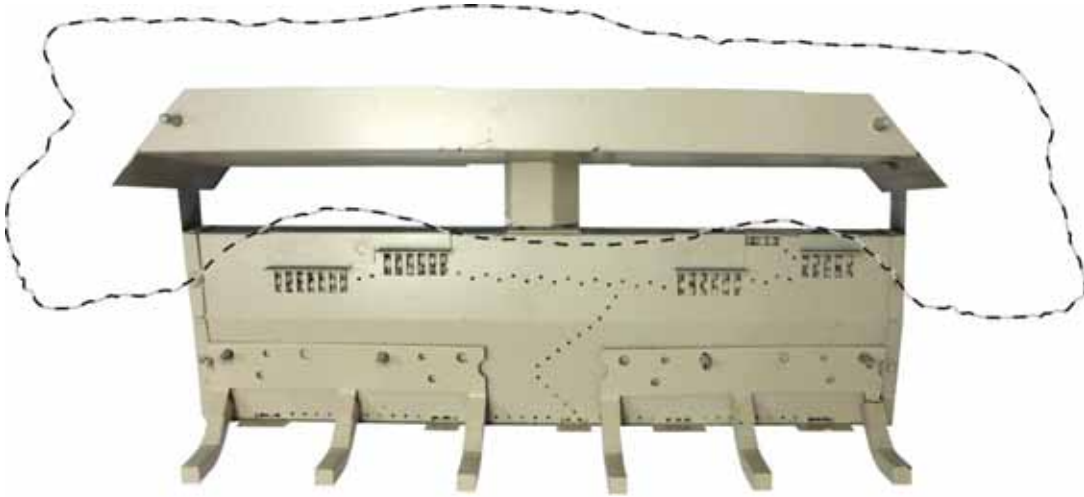

TOP VIEW

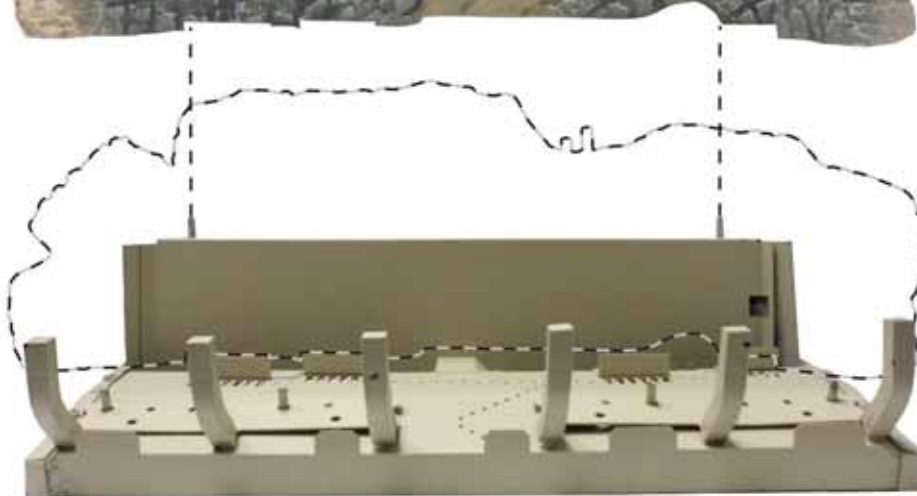

FRONT VIEW

LS-(18,24,30)C2 LOG PLACEMENT

- Place Log B (#2) onto two front left burner pins as shown below.



TOP VIEW

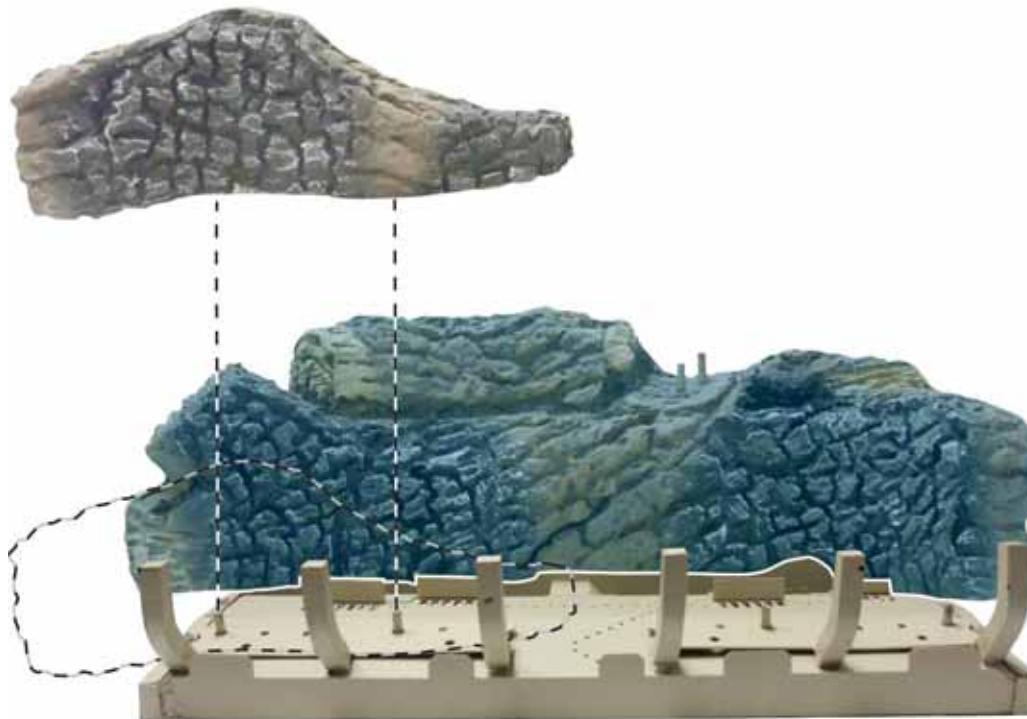

FRONT VIEW

LS-(18,24,30)C2 LOG PLACEMENT

3. Place Log C (#3) onto two front right burner pins as shown below.

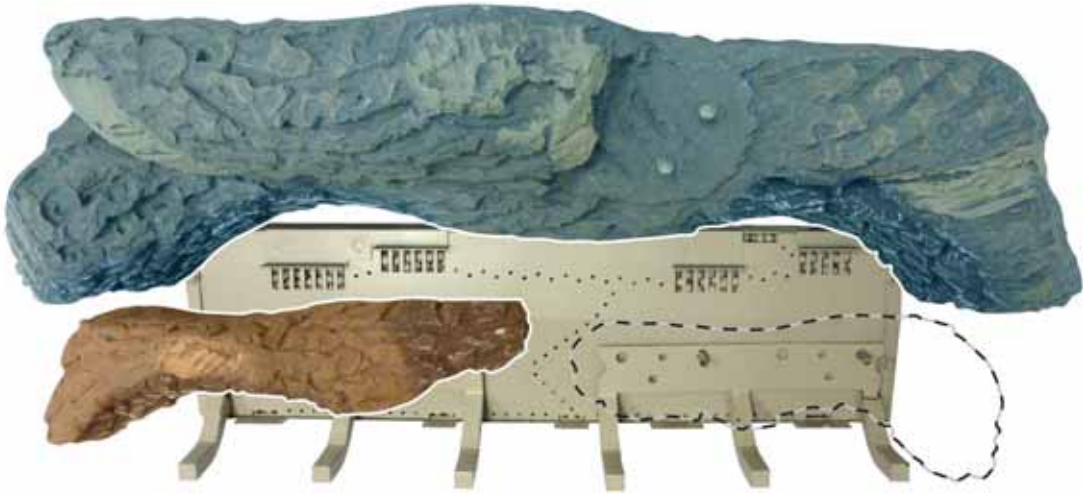

TOP VIEW

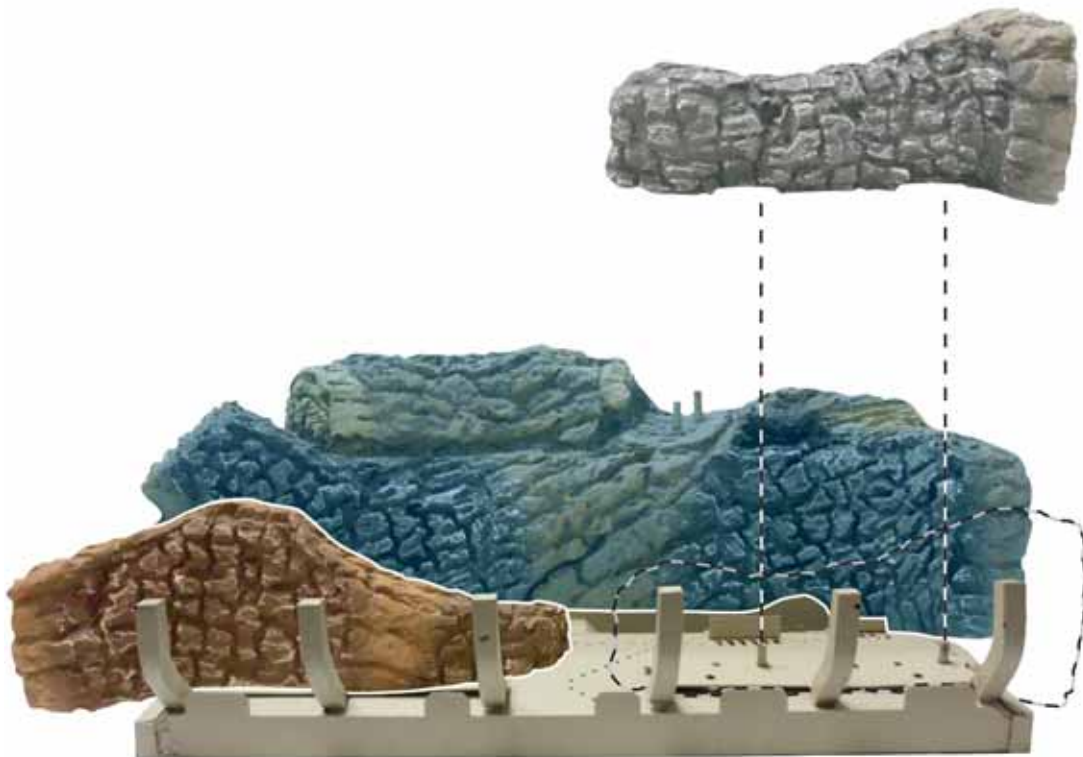

FRONT VIEW

LS-(18,24,30)C2 LOG PLACEMENT

4. Place Log D (#4) onto two pins on Log A (#1) as shown below.

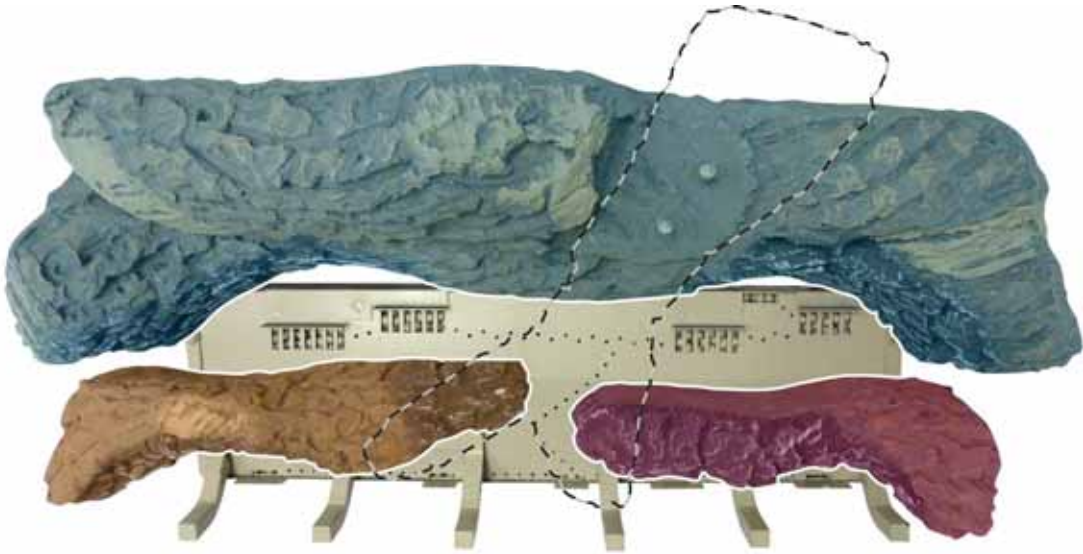

TOP VIEW

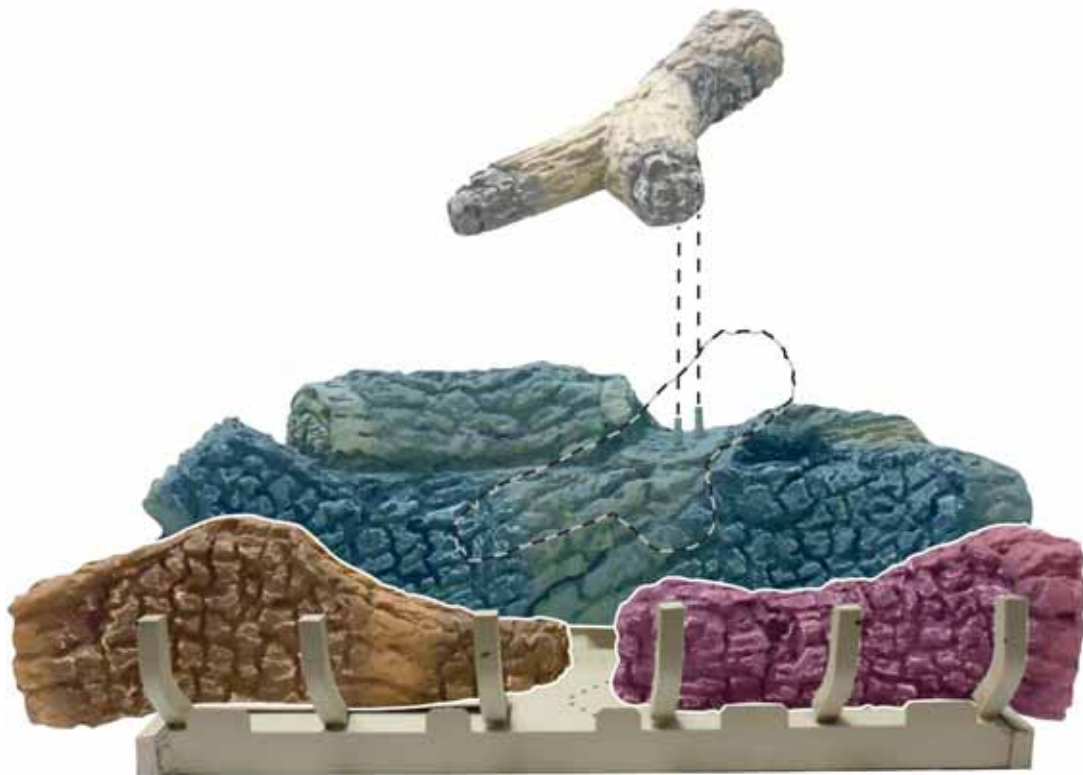

FRONT VIEW

LS-(18,24,30)C2 LOG PLACEMENT

5. Log assembly is completed.

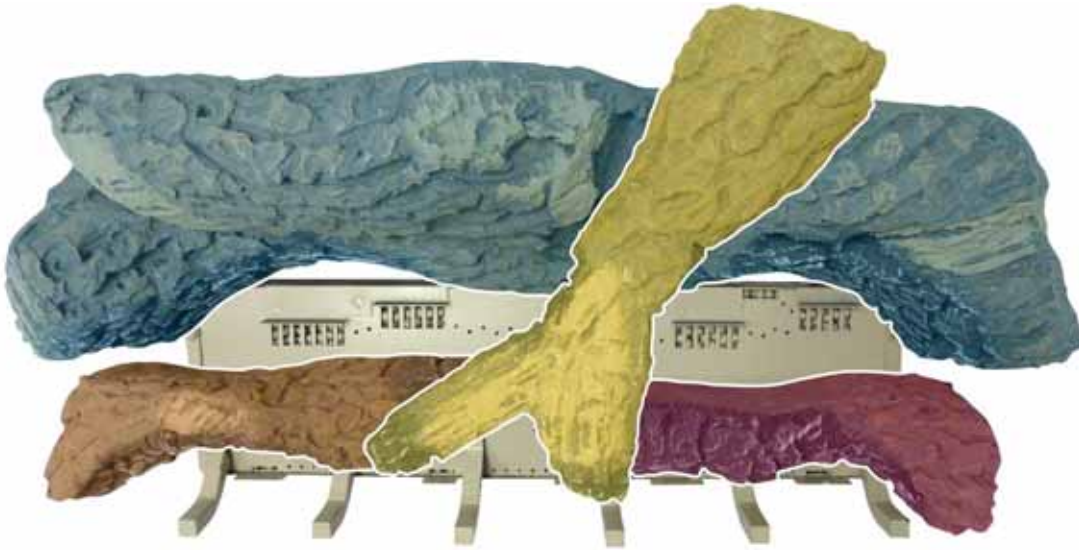

TOP VIEW

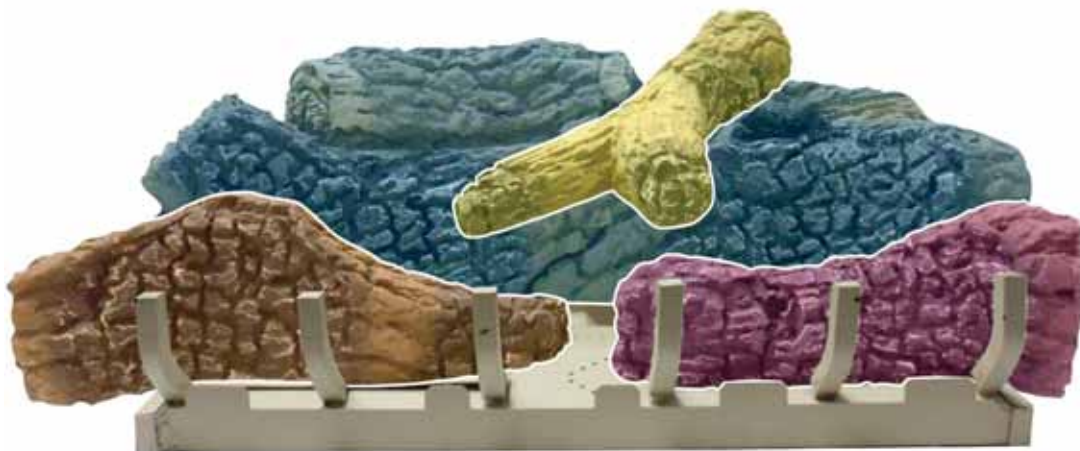

FRONT VIEW

EMBER PLACEMENT LS-18C2 PHOTOS

Do not cover any large rear ports with loose material (glowing embers)

Photo 2

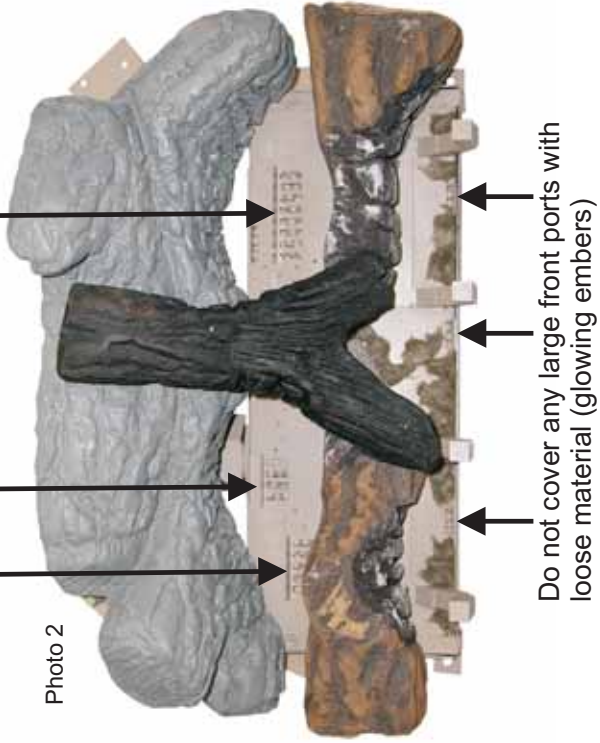

Photo 1

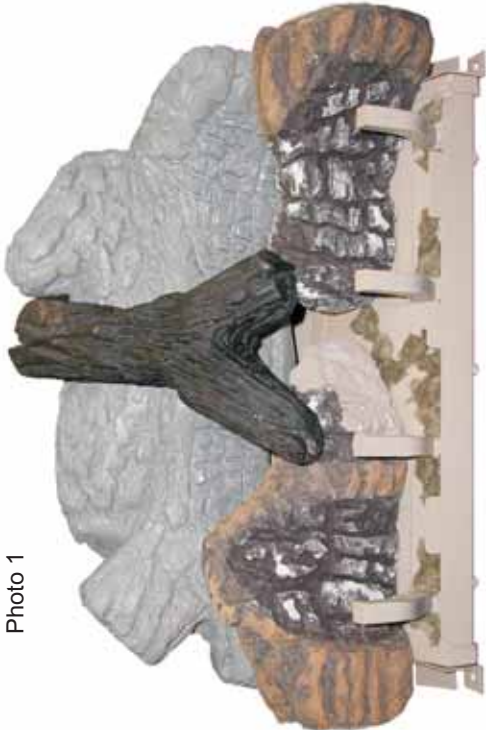

Photo 4



Photo 3



EMBER PLACEMENT LS-24C2 PHOTOS

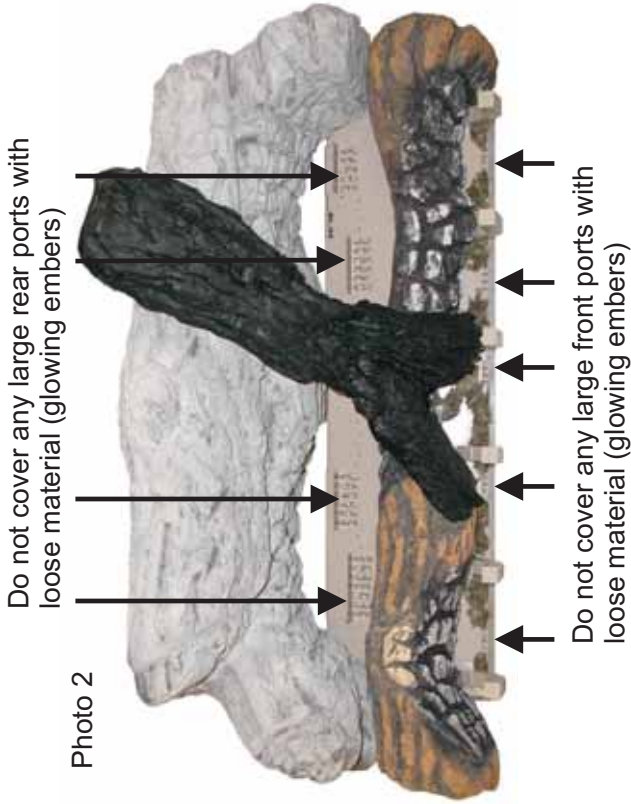

EMBER PLACEMENT LS-30C2 PHOTOS

Do not cover any large rear ports with loose material (glowing embers)

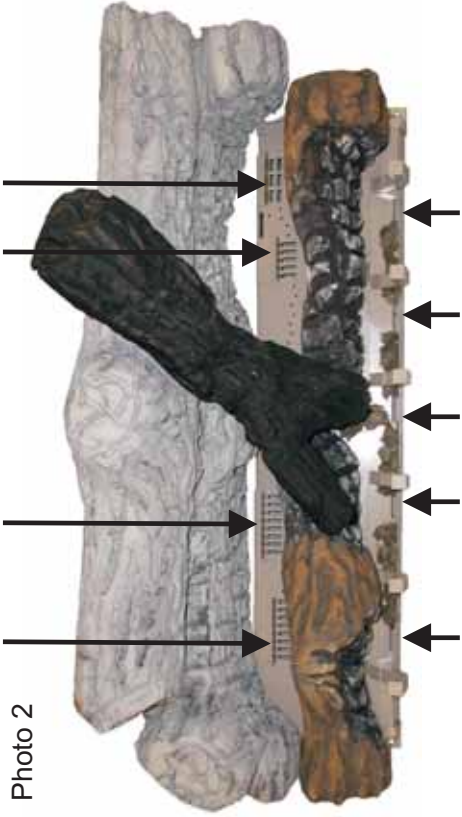

Photo 2



Photo 1

Do not cover any large front ports with loose material (glowing embers)

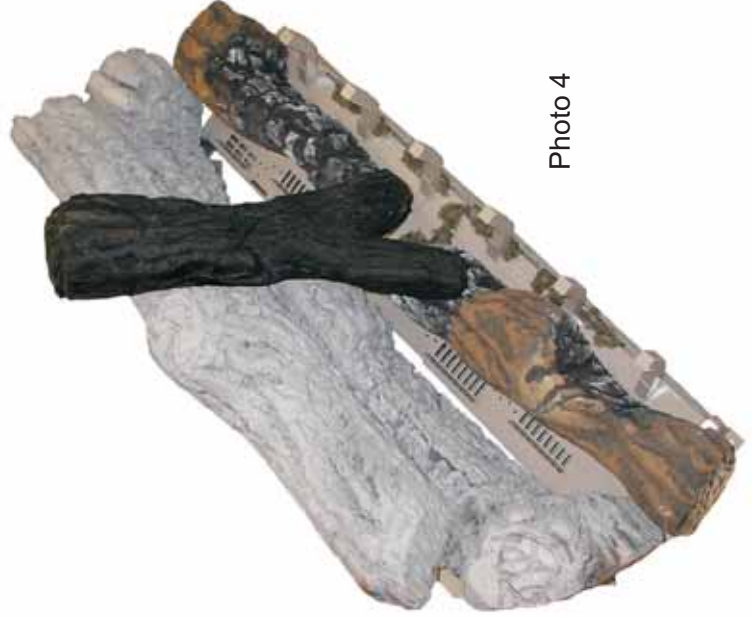

Photo 4



Photo 3

LS-18C2S LOG IDENTIFICATION

Log Description	Part Number	Front View	Top View
Log A	R9182		
Log B	R8299		
Log C	R8300		
Log D	R8302		
Log E	R8312		
Log F	R8313		

LS-18C2S LOG PLACEMENT

Before you begin: Do not, handle these logs with your bare hands! Always wear gloves to prevent skin irritation. After handling logs, wash your hands gently with soap and water.

All Logs

The positioning of the logs is critical to the safe and clean operation of this heater. Sooting and other problems may result if the logs are not properly and firmly positioned in the appliance.

The following WARNING applies when log set is installed onto an unvented gas burner assembly.

⚠ WARNING

This appliance is equipped for (natural or propane) gas. Field conversion is not permitted.

Attention: Do not use Figure 3 to order replacement logs. Refer to Page 46 Parts List and Parts View to order logs for your appropriate model number.

⚠ WARNING

All previously applied loose material must be removed prior to reapplication.

Note: For step by step log placement instructions with images, see pages 26-32.

⚠ WARNING

Failure to position the parts in accordance with this diagram or failure to use only parts specifically approved with this appliance may result in property damage or personal injury

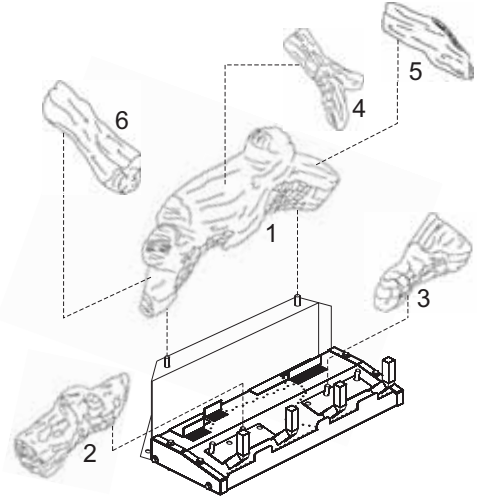

**Log Placement LS-18C2S
Figure 3**

Apply loose material (glowing embers) per appropriate Installation Instructions and Owner's Manual. Replacement of loose material (glowing embers) must be purchased from Empire Comfort Systems, Inc. Application of excess loose material (glowing embers) may adversely affect performance of the heater.

Replacement Loose Material (glowing embers)	Part Number
LS-18C2S	15999
Platinum Bright Embers	PE-20-1

Note: A single layer of embers is to be used when applying Platinum Bright Embers (alone or in combination with production embers) to the burner.

Scan this code to see the log assembly video.



LS-18C2S LOG PLACEMENT

1. Place Log A (#1) onto two rear log support pins as shown below.

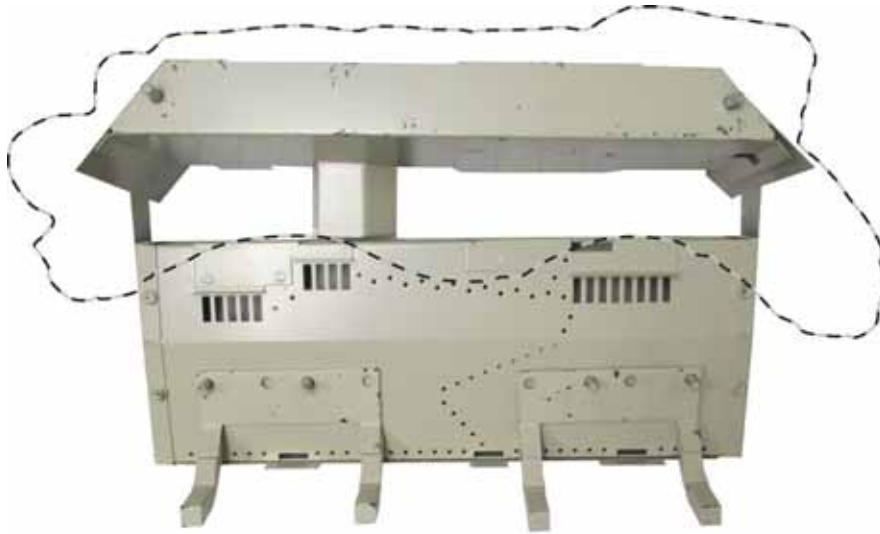

TOP VIEW

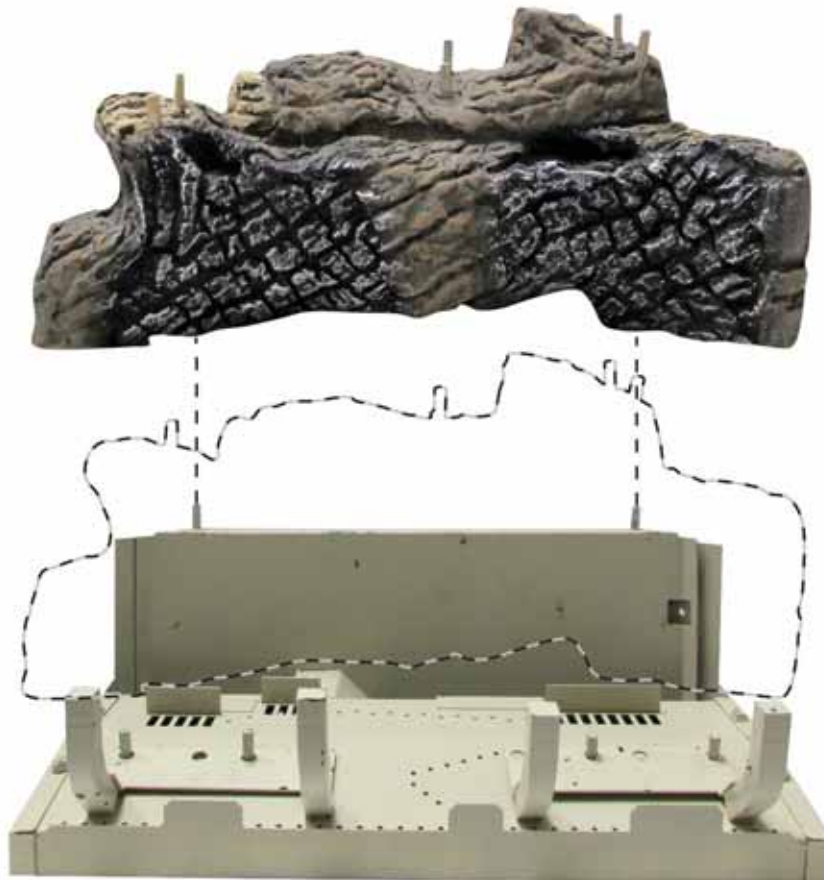

FRONT VIEW

LS-18C2S LOG PLACEMENT

- Place Log B (#2) onto two front left burner pins as shown below.



TOP VIEW

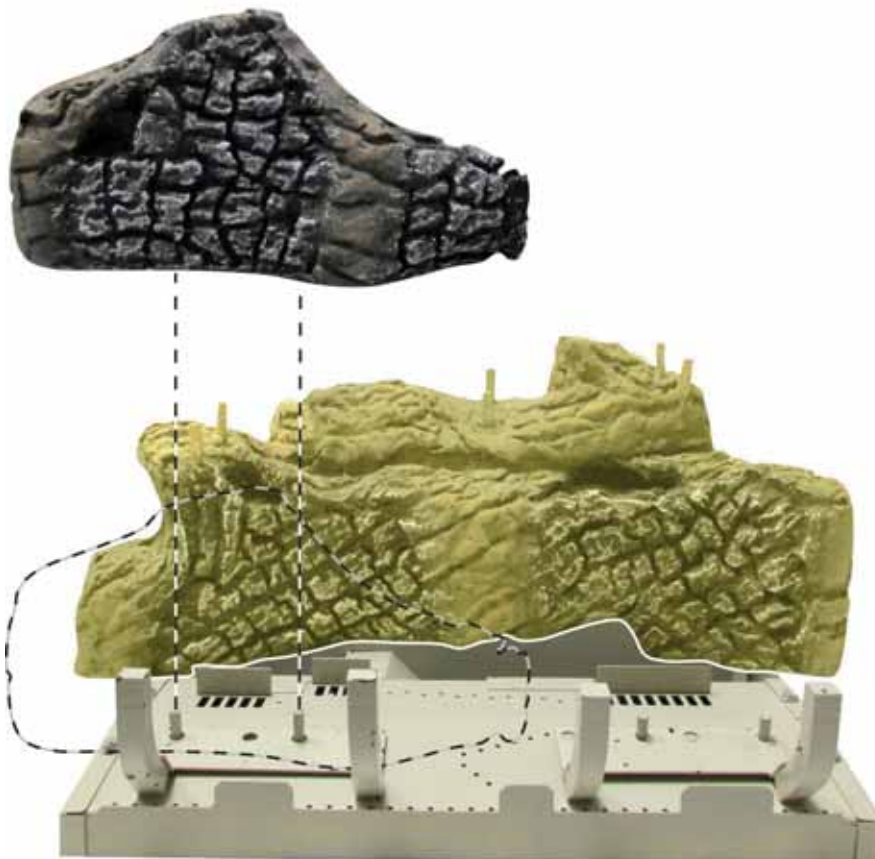

FRONT VIEW

LS-18C2S LOG PLACEMENT

- Place log C (#3) onto two front right burner pins as shown below.



TOP VIEW



FRONT VIEW

LS-18C2S LOG PLACEMENT

4. Place Log D (#4) onto two middle pins on Log A (#1). See image below.



TOP VIEW



FRONT VIEW

LS-18C2S LOG PLACEMENT

5. Place log F (#6) onto two left pins on Log A as shown below.



TOP VIEW



FRONT VIEW

LS-18C2S LOG PLACEMENT

6. Place Log E onto two right pins on Log A as show below.



TOP VIEW



FRONT VIEW

LS-18C2S LOG PLACEMENT

7. Log assembly is completed.



TOP VIEW



FRONT VIEW

EMBER PLACEMENT LS-18C2S PHOTOS

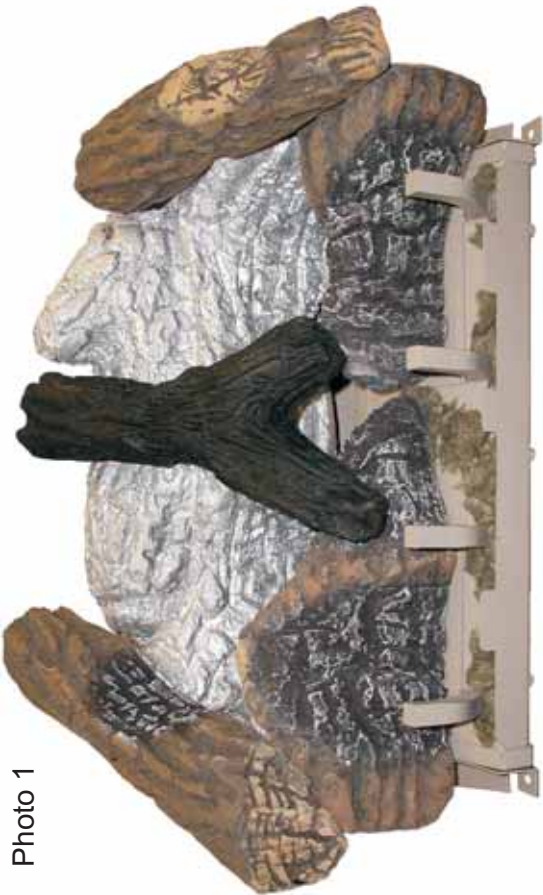

Photo 1

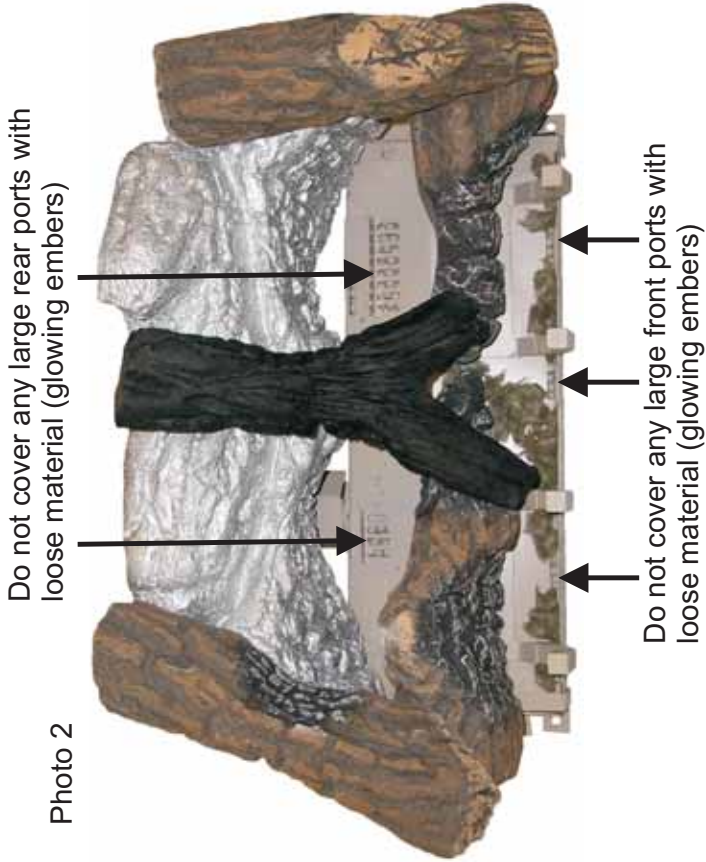

Photo 2















Photo 3



Photo 4

LS-(24,30)C2S LOG IDENTIFICATION

Log Description	Part Number		Front View	Top View
	LS-24C2S	LS-30C2S		
Log A	R9183	R9184		
Log B	R8304	R8308		
Log C	R8305	R8309		
Log D	R8307	R8311		
Log E	R8315	R8317		
Log F	R8316	R8318		

LS(24,30)C2S LOG PLACEMENT

Before you begin: Do not, handle these logs with your bare hands! Always wear gloves to prevent skin irritation. After handling logs, wash your hands gently with soap and water.

All Logs

The positioning of the logs is critical to the safe and clean operation of this heater. Sooting and other problems may result if the logs are not properly and firmly positioned in the appliance.

The following WARNING applies when log set is installed onto an unvented gas burner assembly.

WARNING

This appliance is equipped for (natural or propane) gas. Field conversion is not permitted.

Attention: Do not use Figure 4 to order replacement logs. Refer to Page 46 Parts List and Parts View to order logs for your appropriate model number.

WARNING

All previously applied loose material must be removed prior to reapplication.

Note: For step by step log placement instructions with images, see pages 35-41.

WARNING

Failure to position the parts in accordance with this diagram or failure to use only parts specifically approved with this appliance may result in property damage or personal injury

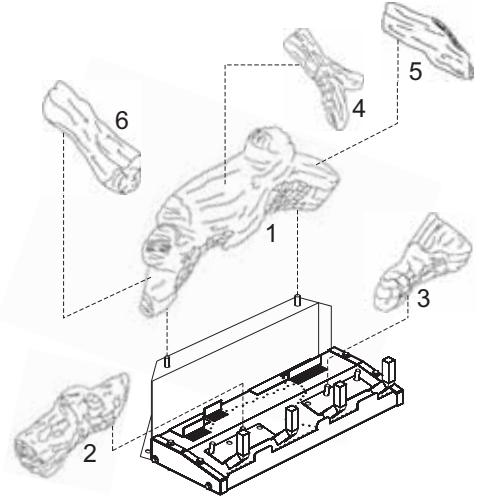

**Log Placement LS(24,30)C2S
Figure 4**

Apply loose material (glowing embers) per appropriate Installation Instructions and Owner's Manual. Replacement of loose material (glowing embers) must be purchased from Empire Comfort Systems, Inc. Application of excess loose material (glowing embers) may adversely affect performance of the heater.

Replacement Loose Material (glowing embers)	Part Number
LS-24C2S	15970
LS-30C2S	15970
Platinum Bright Embers	PE-20-1

Note: A single layer of embers is to be used when applying Platinum Bright Embers (alone or in combination with production embers) to the burner.

Scan this code to see the log assembly video.



LS(24,30)C2S LOG PLACEMENT

1. Place Log A (#1) onto two rear log support pins as shown below.

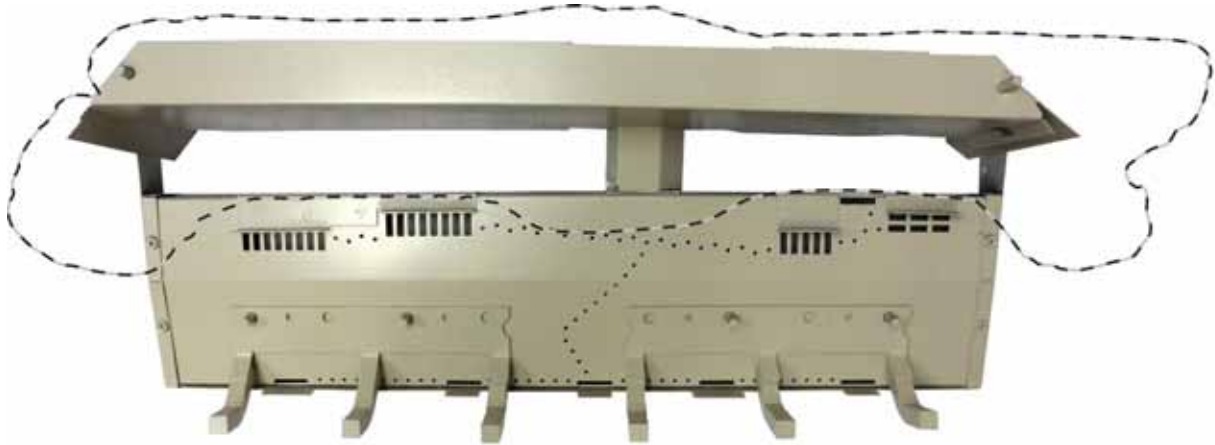

TOP VIEW

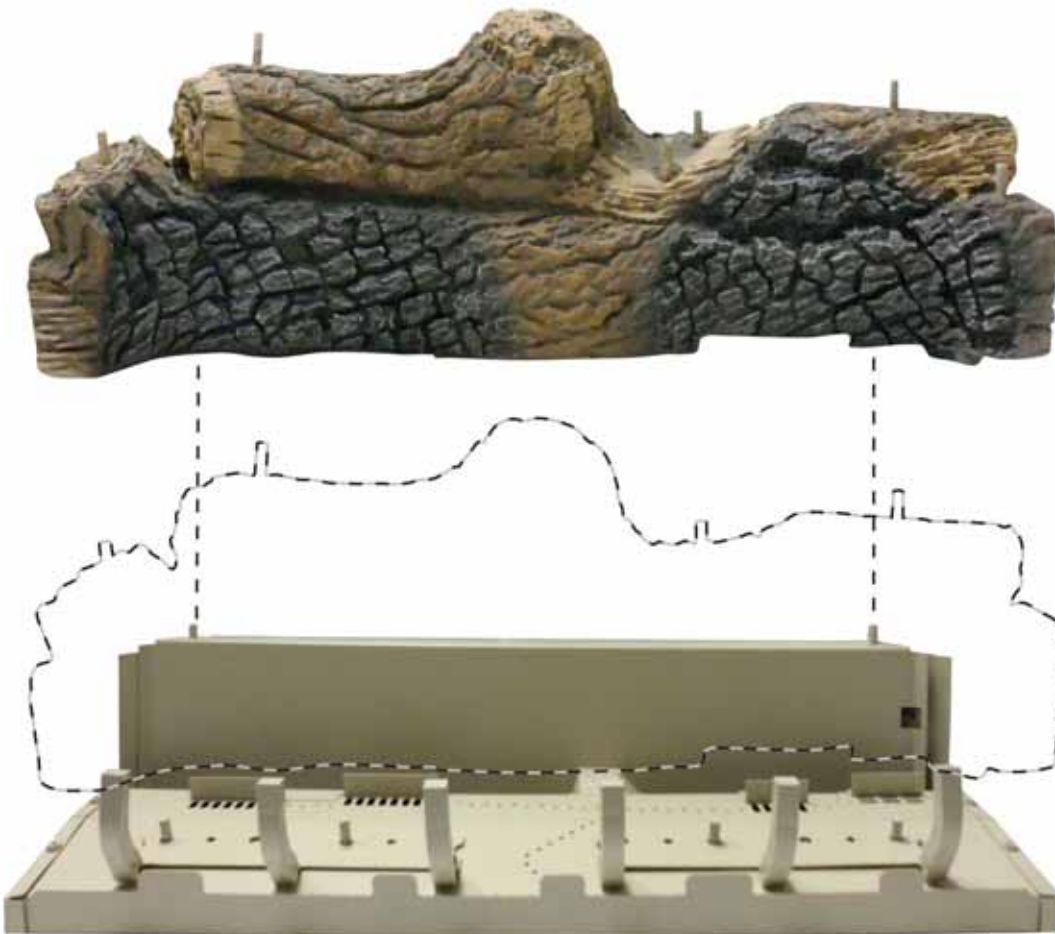

FRONT VIEW

LS(24,30)C2S LOG PLACEMENT

- Place Log B (#2) onto two front left burner pins as shown below.



TOP VIEW

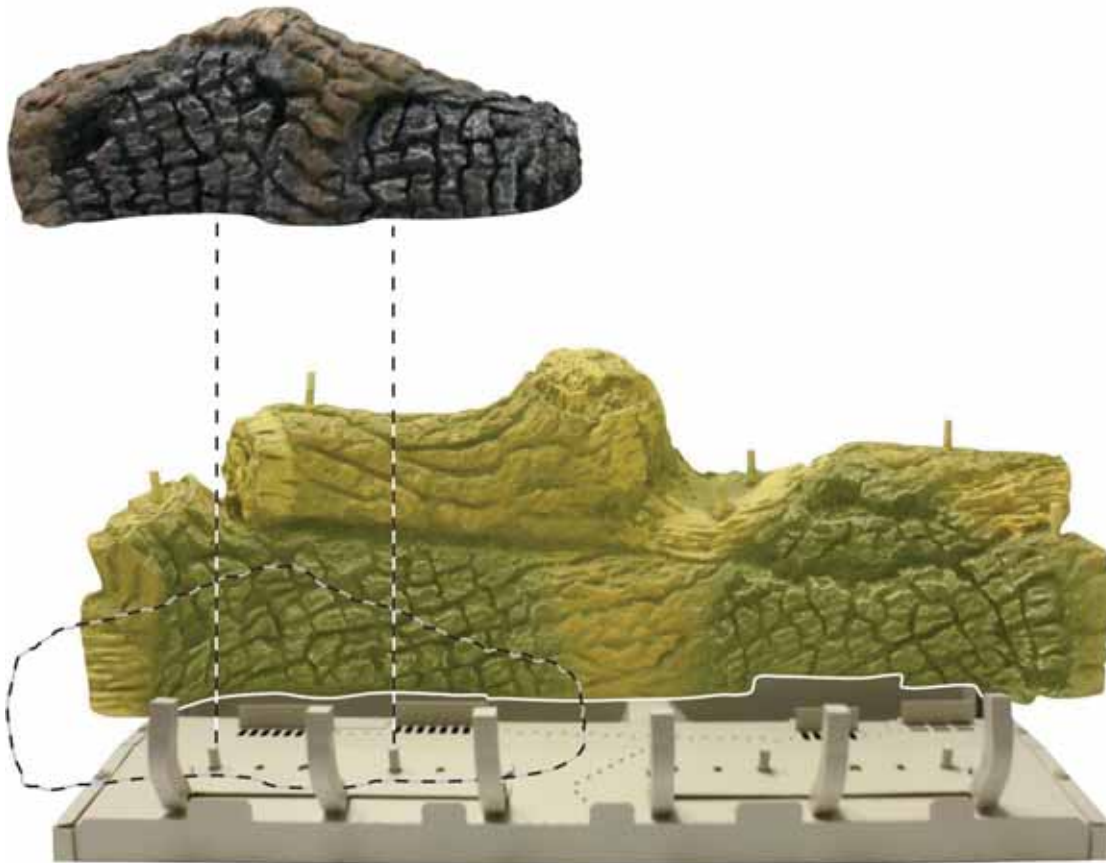

FRONT VIEW

LS(24,30)C2S LOG PLACEMENT

- Place log C (#3) onto two front right burner pins as shown below.

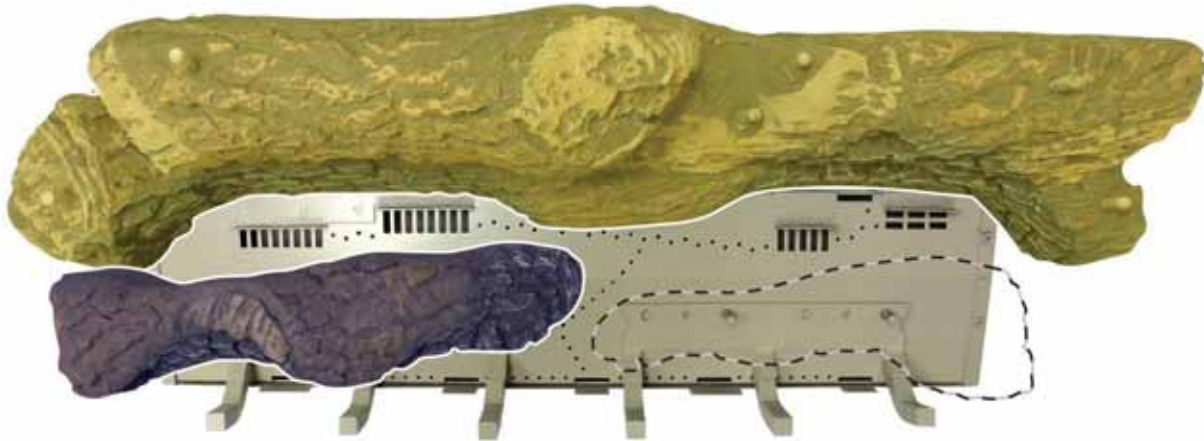

TOP VIEW

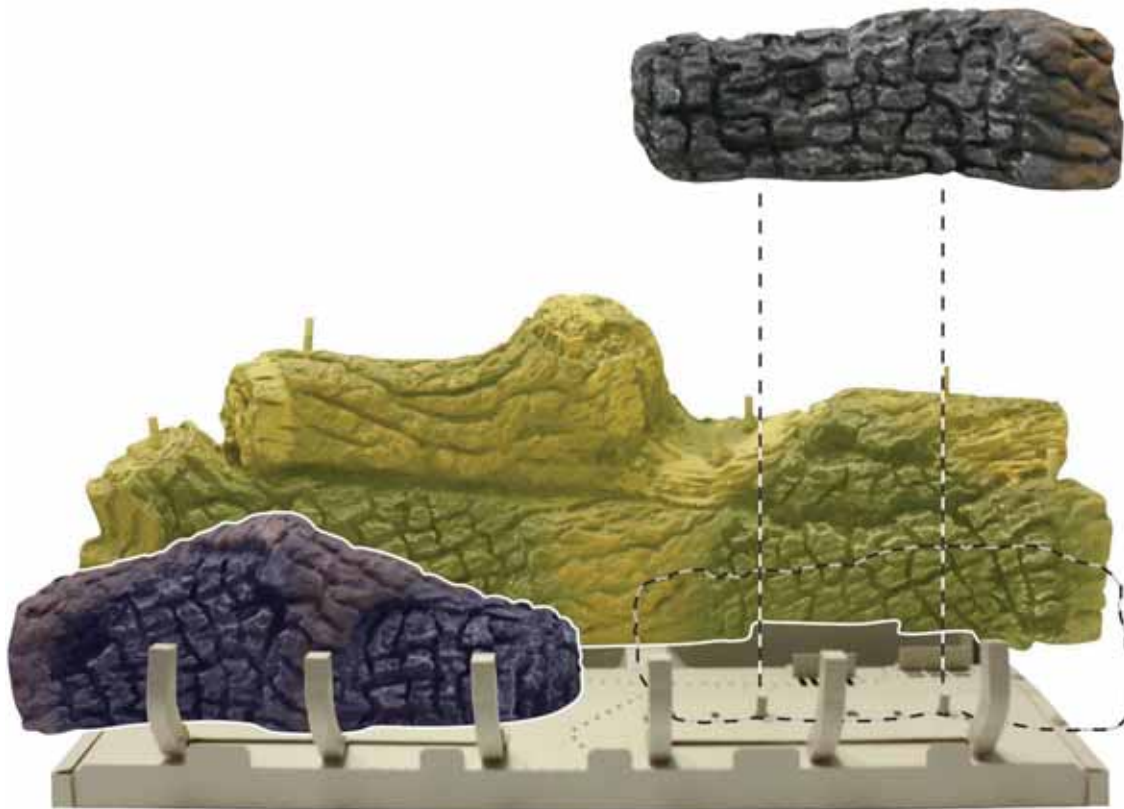

FRONT VIEW

LS(24,30)C2S LOG PLACEMENT

4. Place Log D (#4) onto two middle pins on Log A (#1). See image below.

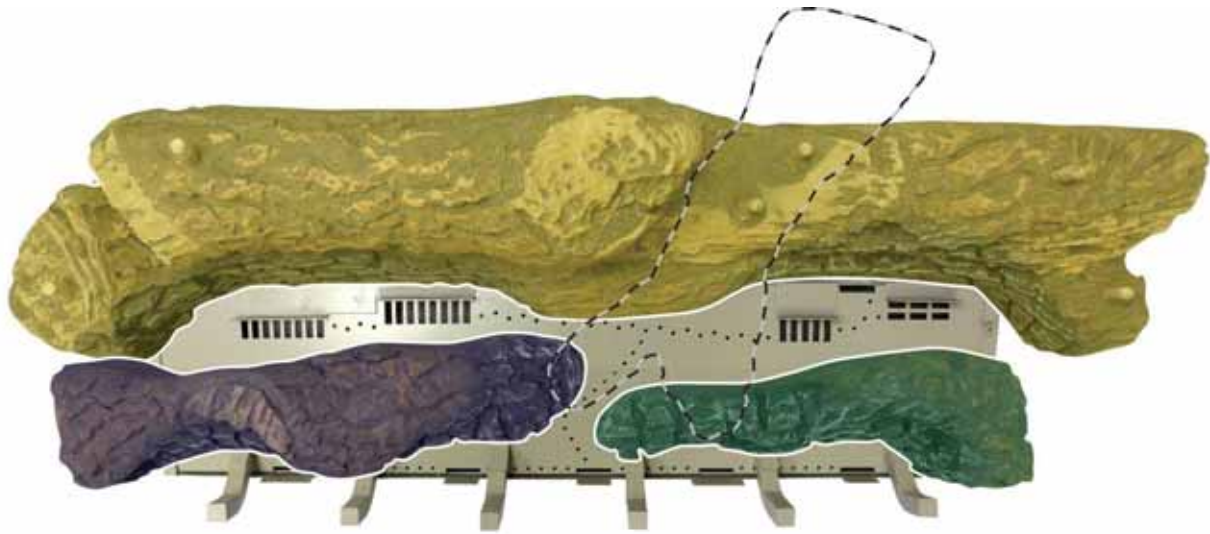

TOP VIEW

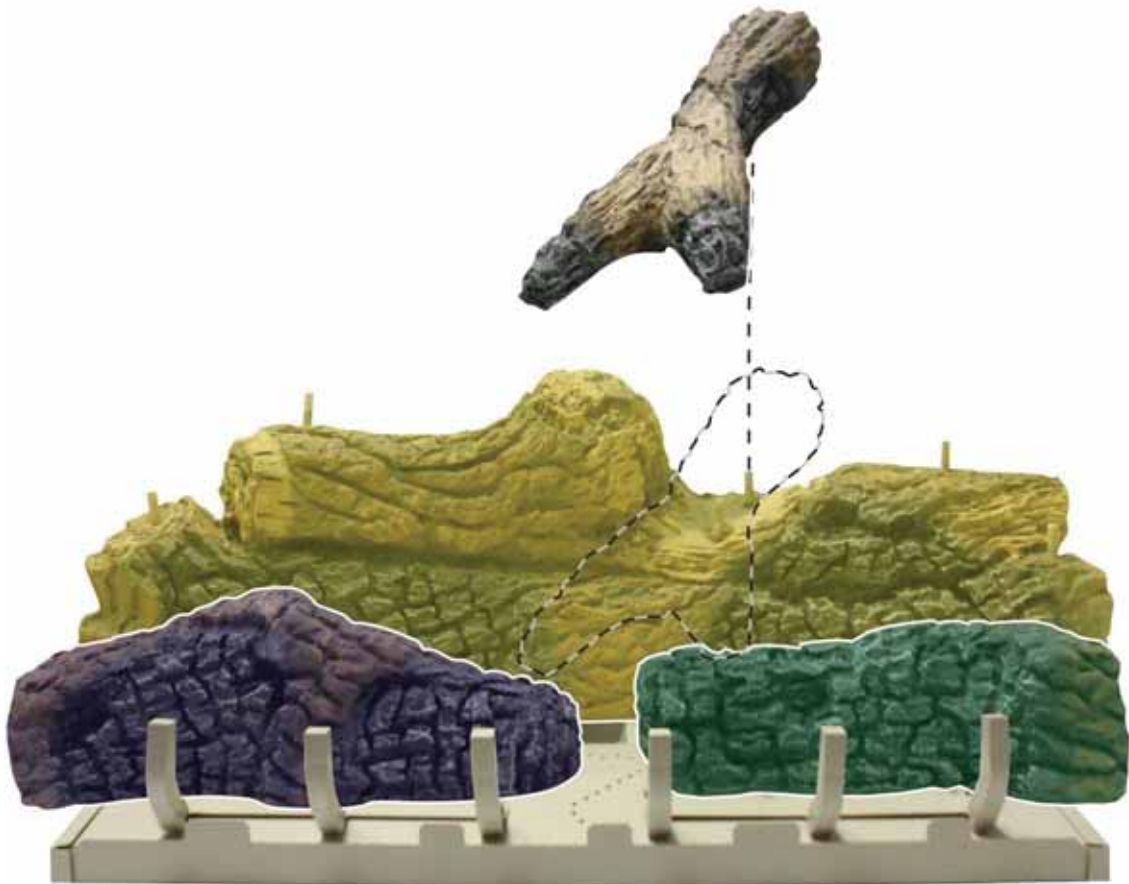

FRONT VIEW

LS(24,30)C2S LOG PLACEMENT

5. Place log F (#6) onto two left pins on Log A as shown below.



TOP VIEW

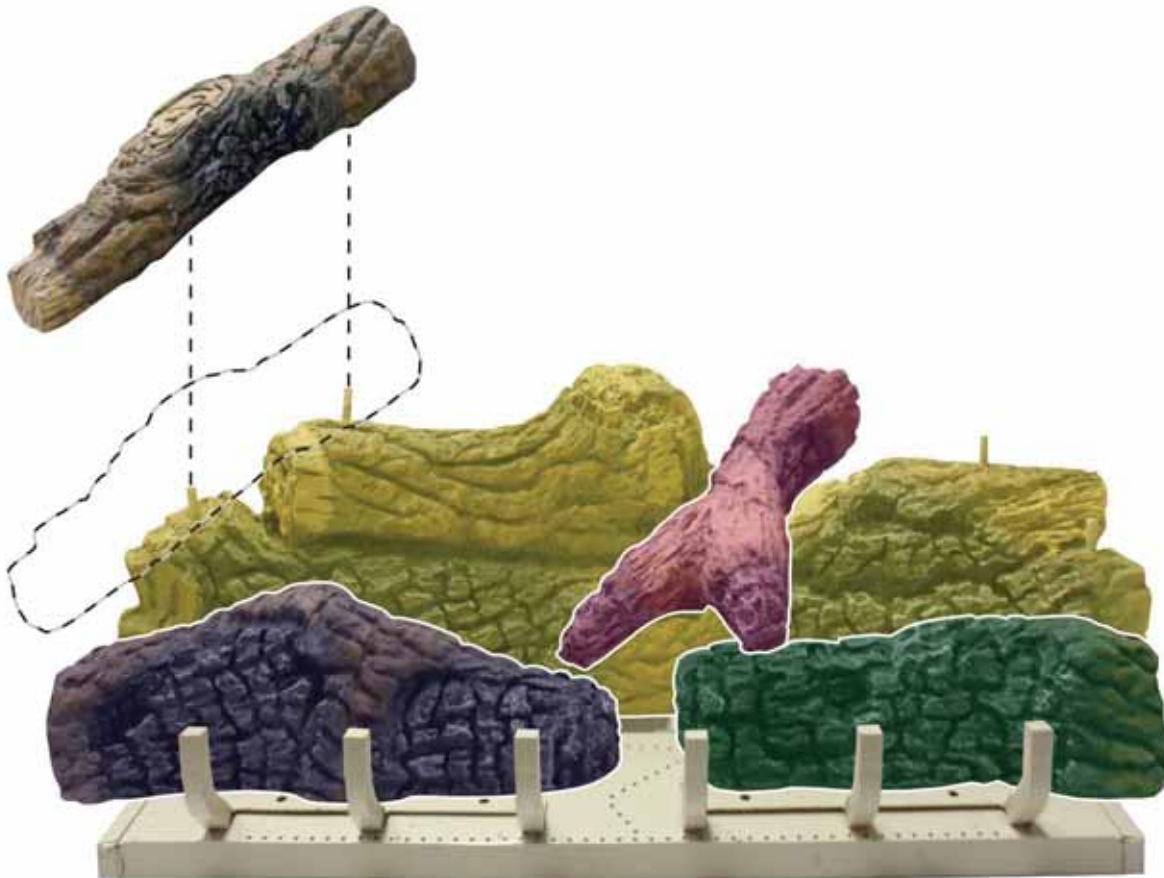

FRONT VIEW

LS(24,30)C2S LOG PLACEMENT

6. Place Log E onto two right pins on Log A as show below.



TOP VIEW



FRONT VIEW

LS(24,30)C2S LOG PLACEMENT

7. Log assembly is completed.



TOP VIEW



FRONT VIEW

EMBER PLACEMENT LS-24C2S PHOTOS

Do not cover any large rear ports with loose material (glowing embers)

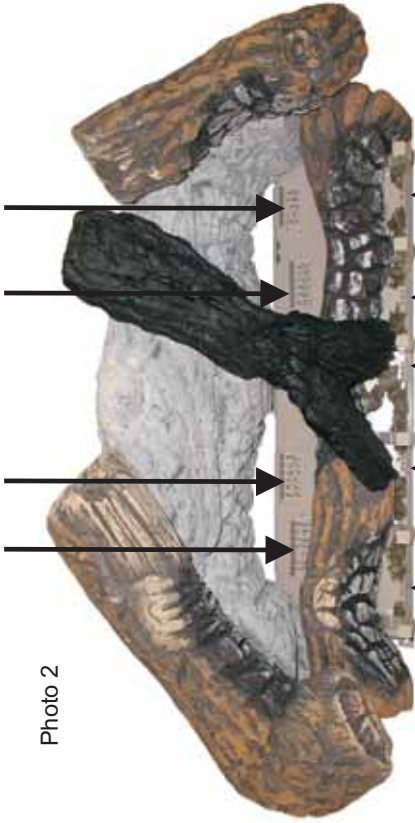

Photo 2

Do not cover any large front ports with loose material (glowing embers)



Photo 4

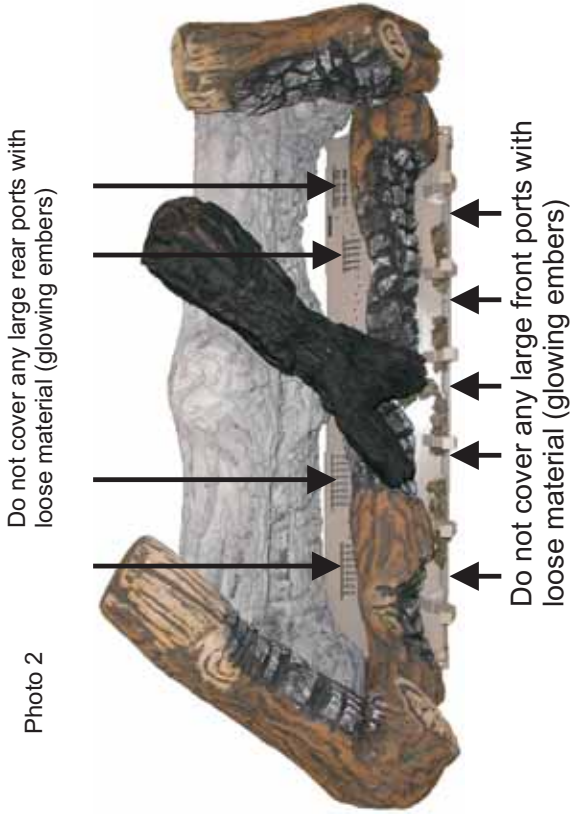

Photo 1



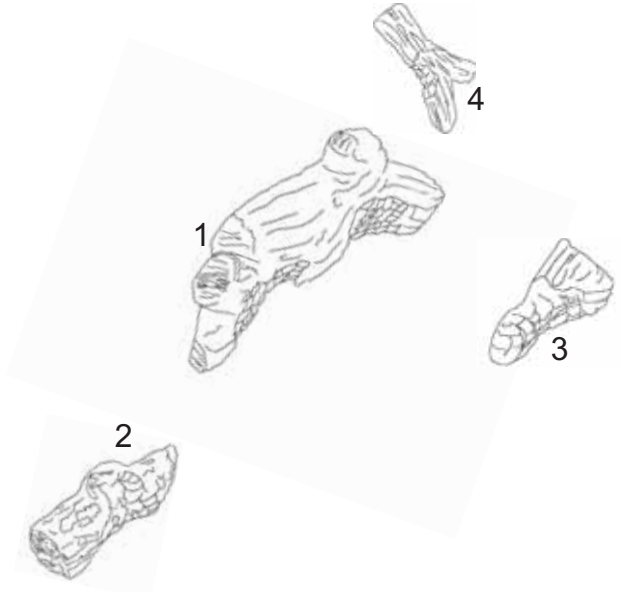
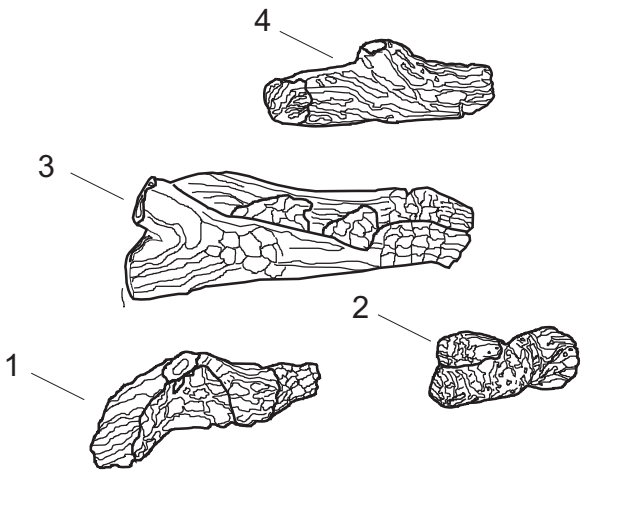

Photo 3

EMBER PLACEMENT LS-30C2S PHOTOS



CHARRED OAK PARTS LIST & PARTS VIEW

Attention: When ordering parts, it is very important that **part number** and **description** of part coincide.

Index No.	Part Number	Description	
CHARRED OAK LOG SETS			
LS-18C2			
1	R-8301	REAR LOG	
2	R-8299	LEFT FRONT LOG	
3	R-8300	RIGHT FRONT LOG	
4	R-8302	Y BRANCH	
LS-24C2			
1	R-8306	REAR LOG	
2	R-8304	LEFT FRONT LOG	
3	R-8305	RIGHT FRONT LOG	
4	R-8307	Y BRANCH	
LS-30C2			
1	R-8310	REAR LOG	
2	R-8308	LEFT FRONT LOG	
3	R-8309	RIGHT FRONT LOG	
4	R-8311	Y BRANCH	
LS-16C-2, CHBR-16			
1	R-7465	LEFT FRONT LOG	
2	R-7466	RIGHT FRONT LOG	
3	R-7467	MIDDLE LOG	
4	R-7468	REAR LOG	

USE ONLY MANUFACTURER'S REPLACEMENT PARTS. USE OF ANY OTHER PARTS COULD CAUSE INJURY OR DEATH.

CHARRED OAK SUPER SIZE PARTS LIST & PARTS VIEW

Attention: When ordering parts, it is very important that **part number** and **description** of part coincide.

Index No.	Part Number	Description
CHARRED OAK SUPER SIZE LOG SETS		
LS-18C2S		
1	R-9182	REAR LOG
2	R-8299	LEFT FRONT LOG
3	R-8300	RIGHT FRONT LOG
4	R-8302	Y BRANCH
5	R-8312	RIGHT TOP LOG
6	R-8313	LEFT TOP LOG
LS-24C2S		
1	R-9183	REAR LOG
2	R-8304	LEFT FRONT LOG
3	R-8305	RIGHT FRONT LOG
4	R-8307	Y BRANCH
5	R-8315	RIGHT TOP LOG
6	R-8316	LEFT TOP LOG
LS-30C2S		
1	R-9184	REAR LOG
2	R-8308	LEFT FRONT LOG
3	R-8309	RIGHT FRONT LOG
4	R-8311	Y BRANCH
5	R-8317	RIGHT TOP LOG
6	R-8318	LEFT TOP LOG



USE ONLY MANUFACTURER'S REPLACEMENT PARTS. USE OF ANY OTHER PARTS COULD CAUSE INJURY OR DEATH.

MASTER PARTS DISTRIBUTOR LIST

To Order Parts Under Warranty, please contact your local Empire dealer. See the dealer locator at www.empirecomfort.com. To provide warranty service, your dealer will need your name and address, purchase date and serial number, and the nature of the problem with the unit.

To Order Parts After the Warranty Period, please contact your dealer or one of the Master Parts Distributors listed below. This list changes from time to time. For the current list, please click on the Master Parts button at www.empirecomfort.com. Please note: Master Parts Distributors are independent businesses that stock the most commonly ordered Original Equipment repair parts for Heaters, Grills, and Fireplaces manufactured by Empire Comfort Systems Inc.

Dey Distributing

1401 Willow Lake Boulevard
Vadnais Heights, MN 55101

Phone: 651-490-9191

Toll Free: 800-397-1339

Website: www.deyistributing.com

Parts: Heater, Hearth and Grills

Victor Division of F. W. Webb Company

200 Locust Street
Hartford, CT 06114

Phone: 860-722-2433

Toll Free: 800-243-9360

Fax: 860-293-0479

Toll Free Fax: 800-274-2004

Websites: www.fwwebb.com & www.victormfg.com

Parts: Heater, Hearth and Grills

East Coast Energy Products

10 East Route 36
West Long Branch, NJ 07764

Phone: 732-870-8809

Toll Free: 800-755-8809

Fax: 732-870-8811

Website: www.eastcoastenergy.com

Parts: Heater, Hearth and Grills

HOW TO ORDER REPAIR PARTS

Parts Not Under Warranty

Parts can be ordered through your Service Person, Dealer, or a Master Parts Distributor. See this page for the Master Parts Distributors list. For best results, the **service person or dealer** should order parts through the distributor. Parts can be shipped directly to the **service person/dealer**.

Warranty Parts

Warranty parts will need a proof of purchase and can be ordered by your Service Person or Dealer. Proof of purchase is **required** for warranty parts.

All parts listed in the Parts List have a Part Number. When ordering parts, first obtain the Model Number and Serial Number from the name plate on your equipment. Then determine the Part Number (**not** the Index Number) and the Description of each part from the following illustration and part list. Be sure to give all this information . . .

Appliance Model Number _____ Part Description _____

Appliance Serial Number _____ Part Number _____

Type of Gas (Propane or Natural) _____

Do not order bolts, screws, washers or nuts. They are standard hardware items and can be purchased at any local hardware store.

Shipments contingent upon strikes, fires and all causes beyond our control.



Empire Comfort Systems Inc.
918 Freeburg Ave. Belleville, IL 62220

If you have a general question about our products, please e-mail us at
info@empirecomfort.com.

If you have a service or repair question, please contact your dealer.