

# OWNER'S MANUAL

Model Nos. GFT1W

GFT1C

GFT1R

GFT1I

# GEORGE FOREMAN™

**LEAN  
MEAN  
TOASTING  
MACHINE**

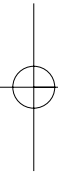
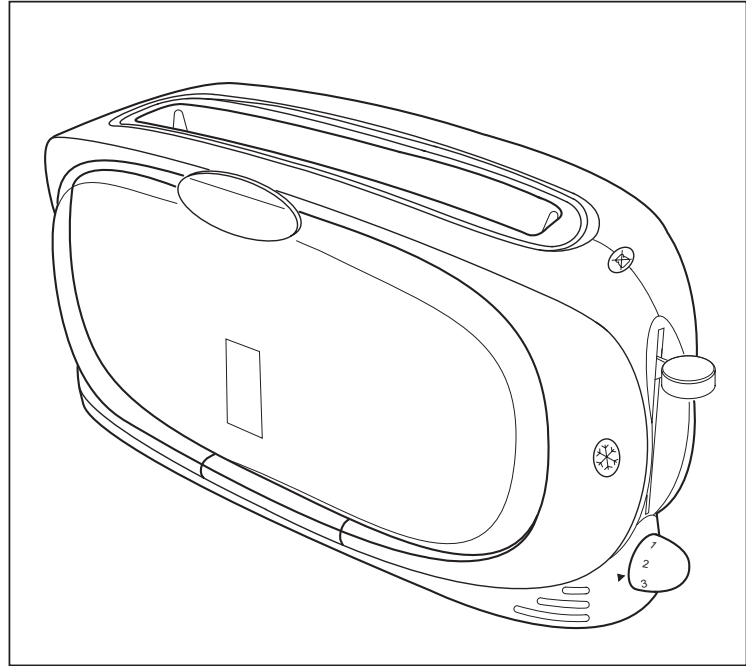

# IMPORTANT SAFEGUARDS

When using electrical appliances, basic safety precautions should always be followed including the following:

1. Read all instructions.
2. Do not touch hot surfaces. Use handles or knobs.
3. To protect against electrical shock do not immerse cord, plugs, or appliance in water or other liquid.
4. Close supervision is necessary when any appliance is used by or near children.
5. Unplug from outlet when not in use, and before cleaning. Allow to cool before putting on or taking off parts.
6. Do not operate any appliance with a damaged cord or plug or after the appliance malfunctions, or has been damaged in any manner. Contact Consumer Service for examination, repair or adjustment.
7. The use of accessory attachments not recommended by the appliance manufacturer may cause injuries.
8. Do not use outdoors.
9. Do not let cord hang over edge of table or counter, or touch hot surfaces.
10. Do not place on or near a hot gas or electric burner, or in a heated oven.
11. To disconnect, press Cancel Button then remove plug from wall outlet.
12. Do not use appliance for other than intended use.
13. Oversize foods, metal foil packages or utensils must not be inserted in a toaster as they may involve a risk of fire or electric shock.
14. A fire may occur if toasters are covered or touching flammable material, including curtains, draperies, walls, and the like, when in operation.
15. Do not attempt to dislodge food when toaster is plugged in.

## SAVE THESE INSTRUCTIONS

### FOR HOUSEHOLD USE ONLY

# Additional Important Safeguards

**CAUTION HOT SURFACES:** This appliance generates heat and escaping steam during use. Proper precautions must be taken to prevent the risk of burns, fires or other injury to persons or damage to property.

**WARNING: ELECTRICAL SHOCK HAZARD.** Never attempt to dislodge food inside the Toaster while the Toaster is plugged in. Doing so could cause an electrical shock hazard or a risk of fire.

**CAUTION:** This appliance is hot during operation and retains heat for some time after turning off. Always use oven mitts when handling hot materials and allow metal parts to cool before cleaning. Do not place anything on top of the Toaster while it is operating or while it is hot.

1. A person who has not read and understood all operating and safety instructions is not qualified to operate this appliance. All users of this appliance must read and understand this Owner's Manual before operating or cleaning this appliance.
2. If this appliance falls or accidentally becomes immersed in water, unplug it from the wall outlet immediately. **Do not reach into the water!**
3. When using this appliance, provide adequate air space above and on all sides for air circulation. Do not operate this appliance while it is touching or near curtains, wall coverings, clothing, dishtowels or other flammable materials.
4. To reduce the risk of fire, do not leave this appliance unattended during use.
5. If this appliance begins to malfunction during use, immediately press the Cancel Button and unplug the cord. Do not use or attempt to repair a malfunctioning appliance!
6. The cord to this appliance should only be plugged into a 120V AC electrical wall outlet.
7. Do not use this appliance in an unstable position.
8. Use the Toaster on a hard, flat surface. Do not place it near a flame or heat or on a soft surface (such as carpet). Avoid placing it where it may tip over during use. Dropping the Toaster could cause it to malfunction.

## **CAUTION:**

- **DO NOT toast pastries with runny fillings or frosting.**
- **DO NOT toast torn slices of bread.**
- **DO NOT place buttered bread or wrapped food into the Toaster.**
- **DO NOT toast small-size breads, mini-baguettes, breadsticks, etc.**

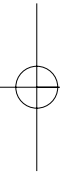

## Polarized Plug

This appliance has a polarized plug (one blade is wider than the other). To reduce the risk of electric shock, this plug is intended to fit into a polarized outlet only one way. If the plug does not fit fully in the outlet, reverse the plug. If it still does not fit, contact a qualified electrician. Do not attempt to modify the plug in any way.

## Short Cord Instructions

A short power-supply cord is provided to reduce the risk resulting from becoming entangled in or tripping over a longer cord.

Do not use an extension cord with this product.

## Electric Power

If the electrical circuit is overloaded with other appliances, your appliance may not operate properly. It should be operated on a separate electrical circuit from other appliances.



## Plasticizer Warning

**CAUTION:** To prevent Plasticizers from migrating from the finish of the countertop or tabletop or other furniture, place **NON-PLASTIC** coasters or placemats between the appliance and the finish of the countertop or tabletop.

**Failure to do so may cause the finish to darken, permanent blemishes may occur or stains can appear.**

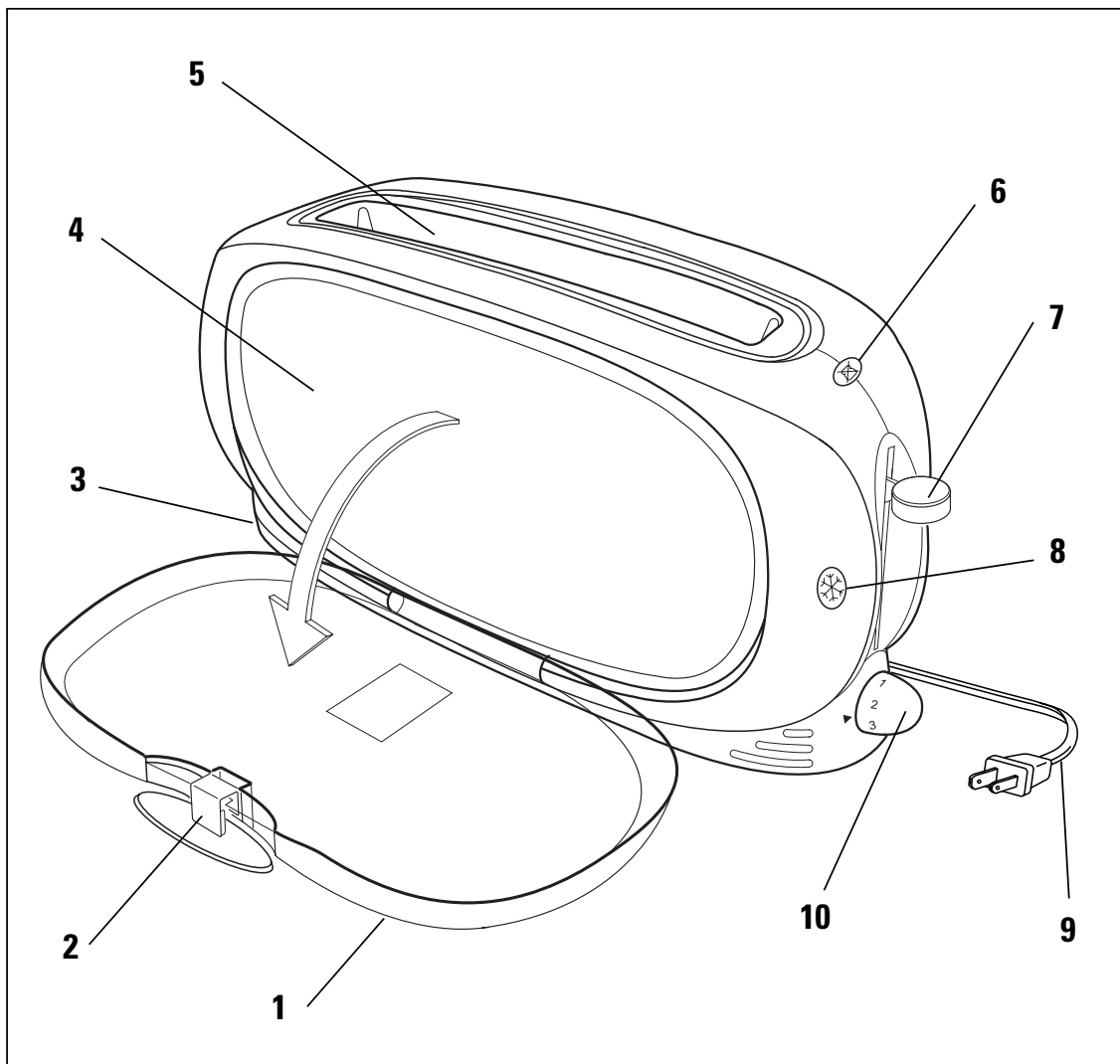
# Getting To Know Your GFT1W/C/R/I 2-Slice Long Slot Toaster



1. Keep-Warm Cover, (Clear P/N 22382C), (Ruby P/N 22382R), (Indigo P/N 22382I)
2. Keep-Warm Cover Latch
3. Crumb Tray (Not Shown), (White P/N 22383W), (Silver P/N 22383S)
4. Keep-Warm Chamber
5. Bread Slot
6. Cancel Button 
7. Carriage Lever
8. Frozen Food Button 
9. Power Cord
10. Browning Control Knob
11. Hinge Release Button
12. Cord Storage Area

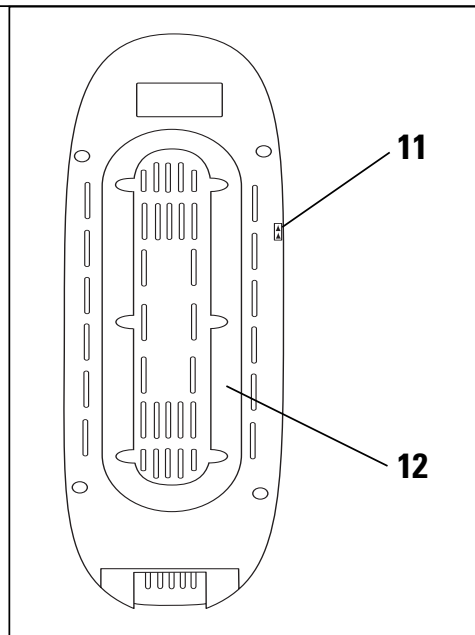

## Before Using for the First Time

1. Remove all packaging materials including those which may be inside the Bread Slot.
2. Wipe the exterior with a damp cloth. Dry thoroughly. Do not use abrasive cleaners.
3. Do not put the Toaster, cord or plug in water.
4. Be sure the Crumb Tray is pushed all the way into the Toaster.
5. Unwrap power cord from Cord Storage Area on underside of Toaster.

## Important Points

- Remove all protective wrappings from food before placing in Bread Slot.
- For best results, clean Crumb Tray frequently.
- Different breads require different color settings. Carriage Lever may be raised manually or press the Cancel Button at any time to check toast color.
- Do not block top openings. Do not place any object over the top openings.
- Do not toast buttered bread or buttered pita bread. Melted butter will cause fire.
- Bread which has been toasted but not buttered may be reheated. Use a lighter setting and watch it carefully.
- When toasting more than one slice of bread, use slices of similar size, thickness and freshness.
- Stale bread, thin bread or sweet bread products, such as tea cakes and fruit loaf, brown much more quickly than ordinary bread, so they should be toasted on the lighter settings.
- Never immerse Toaster, Cord or Plug in water or other liquid.
- **Never use a fork or sharp-edged utensil to remove toast, because that may damage the heating element or cause injury.**

# Instructions for Use

## Toasting

1. Be sure no bread or other objects are inside the Bread Slot. Place Toaster on a flat, level, heat resistant surface and plug the power cord into a 120V AC electrical outlet.
2. Turn the Browning Control Knob to desired setting. Position 1 is the lightest setting and position 7 is the darkest. You may want to experiment with the Browning Control to determine your preference.
3. Remove any protective wrappings from food before placing into Bread Slot.
4. Press down on the Carriage Lever until it lowers the bread and locks into position at the bottom of the Carriage Slide. The centering guides will automatically center the bread for even toasting.

**NOTE:** The Carriage Lever will not lock into position unless the Toaster is plugged in.

5. As soon as the Carriage Lever locks into position, the Cancel Button will illuminate and the Toaster will begin heating. The first time you use your Toaster, you may notice a slight odor. This is normal and will stop as the heating elements continue to heat.
6. The bread will toast to the selected setting then automatically rise when done. The Cancel Button and the heating elements will turn off when the bread rises.

**NOTE:** DO NOT change the Browning Control selection during the toasting cycle. Press the Cancel Button, change the setting and replace bread if desired.

**Cancel Function:** To stop or interrupt the toasting cycle, press the Cancel Button. The bread will automatically rise and the Toaster will turn off.

7. Remove bread from Bread Slot. **Use care as the bread and Toaster will still be hot.**
8. Repeat steps 3-4 for additional toast as desired. See Keep-Warm instructions on the next page.
9. When all toasting is complete, unplug Toaster from electrical outlet and allow it to cool completely.

**NOTE:** To prevent a fire hazard, never place bread over the opening of a Toaster, but always place it into the Bread Slot or Keep-Warm Chamber.

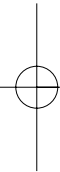

# Instructions for Use (Cont.)

## Keep-Warm

**WARNING: FIRE HAZARD:** Always operate the Toaster in the upright position. Never attempt to operate the toaster on its side.

Use this feature to keep toasted bread fresh and warm while making additional toast or preparing other foods.

1. Press down on the Keep-Warm Cover Latch and open the Cover.
2. Place toasted bread in the Keep-Warm Chamber then close and latch the Cover.
3. Follow the Toasting instructions for making additional toast or press down on the Carriage Lever to simply maintain heat in the Keep-Warm Chamber.
4. When all toasting is complete, unplug the Toaster.

## Frozen Food Function

This feature takes the guesswork out of toasting frozen bread.

1. Turn the Browning Control Knob to your preferred setting.
2. Place the frozen bread into the Bread Slot, press down on the Carriage Lever THEN press the Frozen Food Button. Toasting time will be automatically altered to result in the same degree of browning you would get with unfrozen bread.

**NOTE:** This function will NOT work properly if you press the Frozen Food Button, THEN place the bread in the slot and lower the Carriage.

**Reheating Toast** - To reheat toast, turn the Browning Control Knob to position 1, insert the toast and press down on the Carriage Lever. Watch it carefully. Do not reheat buttered bread.

**Pastries** - For best results, follow the instructions printed on the pastry package. If the package does not have instructions, position the Browning Control Knob in the center. Some pastries may require a second toasting cycle.

**NOTE:** Do not use this Toaster for toasting pastry items with runny-type frosting or open fillings.

**Removing Lodged Toast** - If a piece of toast becomes lodged in the Bread Slot, unplug the Toaster and allow it to cool. Hold the Carriage Lever down. Turn the Toaster upside down and shake the toast loose.

**IMPORTANT:** Never use a fork or sharp-edged utensil to remove toast, because that may damage the heating element or cause injury.



# User Maintenance Instructions

This George Foreman™ 2-Slice Long Slot Toaster requires little maintenance. It contains no user serviceable parts. Do not try to repair it yourself. Any servicing requiring disassembly other than cleaning must be performed by a qualified appliance repair technician.

## Cleaning

**CAUTION: Do not immerse Toaster, Cord, or Plug in water or other liquid.**

1. Always unplug the Toaster and allow it to cool fully before cleaning.
2. **Crumb Tray:** The Crumb Tray is located at the bottom of the Toaster. For ease in cleaning, grasp the Crumb Tray Handle and pull all the way out. Brush crumbs from the Tray and, if necessary, wipe with a clean, damp cloth. Always dry the Tray thoroughly before replacing. When replacing the Tray, be sure to push firmly so that it is fully inserted in the bottom of the Toaster.
3. **Keep-Warm Cover:** To remove the Cover, turn the Toaster on its side, Cover facing up. Pull down on the Keep-Warm Cover Latch and raise the Cover. Slide the Hinge Release Button to the right. This button is located on the bottom of the Toaster. Lift the right side of the hinge up then slide the Keep-Warm Cover to the right to release the left hinge pin. Wash the Cover with a soft cloth in warm, soapy water. Rinse and dry thoroughly. Wipe out any crumbs in the Keep-Warm Chamber with a soft, damp cloth. Do not use abrasive cleansers, as they may scratch the surfaces.

To reinstall the Keep Warm Cover, insert the left hinge pin into the opening, slide the Hinge Release Button to the right and lower the right side of the hinge into position. Release the Hinge Release Button and close the Keep-Warm Cover.

4. **Exterior:** Wipe surfaces with a clean, damp cloth. Do not use abrasive cleansers, as they may scratch the surface.

## Storage

Unplug unit, allow to cool, and clean before storing. Store in its box in a clean, dry place. Never store it while it is hot or still plugged in. Never wrap cord tightly around the appliance, use the Cord Storage Area on the bottom of the Toaster. Do not put any stress on the cord where it enters the unit, as it could cause the cord to fray and break.

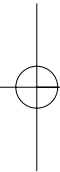

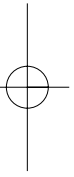

C  
s  
b  
V  
in  
e  
C  
ti  
a  
to  
1

2

3

4

5

6

7

8

C

- 
- 
- 
-

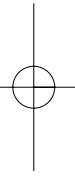

## LIMITED ONE YEAR WARRANTY

**Warranty:** This George Foreman™ product is warranted by Salton, Inc. to be free from defects in materials or workmanship for a period of (1) year from the original purchase date. This product warranty covers only the original consumer purchaser of the product.

**Warranty Coverage:** This warranty is void if the product has been damaged by accident in shipment, unreasonable use, misuse, neglect, improper service, commercial use, repairs by unauthorized personnel, normal wear and tear, improper assembly, installation or maintenance abuse or other causes not arising out of defects in materials or workmanship. This warranty is effective only if the product is purchased and operated in the USA, and does not extend to any units which have been used in violation of written instructions furnished with the product or to units which have been altered or modified or to damage to products or parts thereof which have had the serial number removed, altered, defaced or rendered illegible.

**Implied Warranties:** ANY IMPLIED WARRANTIES WHICH THE PURCHASER MAY HAVE ARE LIMITED IN DURATION TO ONE (1) YEAR FROM THE DATE OF PURCHASE. Some states do not allow limitations on how long an implied warranty lasts, so the above limitation may not apply to you.

**Warranty Performance:** During the above one-year warranty period, a product with a defect will be either repaired or replaced with a reconditioned comparable model (at our option) when the product is returned to the Repair Center, or the purchase price refunded. The repaired or replacement product will be in warranty for the balance of the one-year warranty period and an additional one-month period. No charge will be made for such repair or replacement.

**Service and Repair:** Should the appliance malfunction, you should first call toll-free 1 (800) 937-3883 between the hours of 9:00 am and 5:00 pm Central Standard Time and ask for CONSUMER SERVICE stating that you are a consumer with a problem. Please refer to model number GFT1W/C/R/I when you call.

**In-Warranty Service (USA):** For an appliance covered under the warranty period, no charge is made for service or postage. Call for return authorization (1 800 937-3883).

**Out-of Warranty Service:** A flat rate charge by model is made for out-of-warranty service. Include \$8.00 (U.S.) for return shipping and handling. We will notify you by mail of the amount of the charge for service and require you to pay in advance for the repair or replacement.

**For Products Purchased in the USA, but Used in Canada:** You may return the product insured, packaged with sufficient protection, and postage and insurance prepaid to the USA address listed below. Please note that all customs duty / brokerage fees, if any, must be paid by you and we will require you to pay the cost of customs duty / brokerage fees to us in advance of our performing any service.

**Risk During Shipment:** We cannot assume responsibility for loss or damage during incoming shipment. For your protection, carefully package the product for shipment and insure it with the carrier. Be sure to enclose the following items with your appliance: any accessories related to your problem, your full return address and daytime phone number, a note describing the problem you experienced, a copy of your sales receipt or other proof of purchase to determine warranty status. C.O.D. shipments cannot be accepted.

**To return the appliance, ship to:**

Attn: Repair Center  
Salton, Inc.  
708 South Missouri Street  
Macon, MO 63552

**To contact us, please write to, call, or email:**

Salton, Inc.  
P.O. Box 1526  
Columbia, MO 65205-1526  
1 800 937-3883  
Email: Salton@Saltonusa.com

**Limitation of Remedies:** No representative or person is authorized to assume for Salton, Inc. any other liability in connection with the sale of our products. There shall be no claims for defects or failure of performance or product failure under any theory of tort, contract or commercial law including, but not limited to negligence, gross negligence, strict liability, breach of warranty and breach of contract. Repair, replacement or refund shall be the sole remedy of the purchaser under this warranty, and **in no event shall Salton be liable for any incidental or consequential damages, losses or expenses.** Some states do not allow the exclusion or limitation of incidental or consequential damages, so the above limitation or exclusion may not apply to you.

**Legal Rights:** This warranty gives you specific legal rights, and you may also have other rights which vary from state to state.

George Foreman is a trademark of Salton, Inc.

For more information on Salton products: Visit our website: <http://www.eSalton.com>

© 2003 Salton, Inc.  
All Rights Reserved

P/N 61386  
Printed in China