

MONESSEN

HEARTH SYSTEMS

DESIGNER SERIES

624BVSTNV/624BVSTNE, 624BVPFNV/624BVPFNE
624BVCLNV/624BVCLNE, 624BVCRNV/624BVCRNE,
624BVBYNV/624BVBYNE

B-VENT SPECIALTY GAS FIREPLACE SYSTEM

INSTALLATION, OPERATION AND MAINTENANCE MANUAL

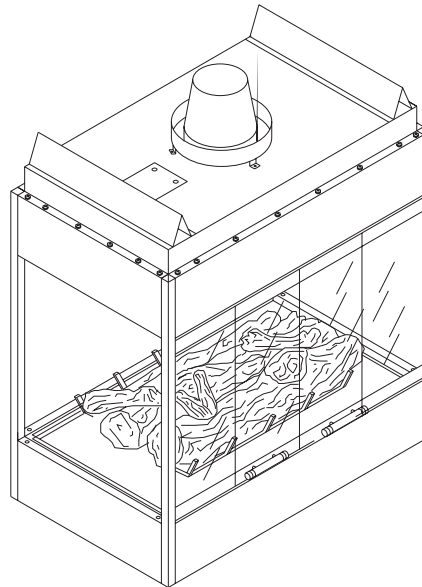

WARNING: IF THE INFORMATION IN THIS MANUAL IS NOT FOLLOWED EXACTLY, A FIRE OR EXPLOSION MAY RESULT CAUSING PROPERTY DAMAGE, PERSONAL INJURY OR LOSS OF LIFE.

DO NOT STORE OR USE GASOLINE OR OTHER FLAMMABLE VAPORS AND LIQUIDS IN THE VICINITY OF THIS OR ANY OTHER APPLIANCE.

WHAT TO DO IF YOU SMELL GAS

- DO NOT TRY TO LIGHT ANY APPLIANCE.
- DO NOT TOUCH ANY ELECTRICAL SWITCH; DO NOT USE ANY PHONE IN YOUR BUILDING.
- IMMEDIATELY CALL YOUR GAS SUPPLIER FROM A NEIGHBOR'S PHONE. FOLLOW THE GAS SUPPLIER'S INSTRUCTIONS.
- IF YOU CANNOT REACH YOUR GAS SUPPLIER, CALL THE FIRE DEPARTMENT.

INSTALLATION AND SERVICE MUST BE PERFORMED BY A QUALIFIED INSTALLER, SERVICE AGENCY OR THE GAS SUPPLIER.

"WARNING: IF NOT INSTALLED, OPERATED AND MAINTAINED IN ACCORDANCE WITH THE MANUFACTURER'S INSTRUCTIONS, THIS PRODUCT COULD EXPOSE YOU TO SUBSTANCES IN FUEL OR FROM FUEL COMBUSTION WHICH CAN CAUSE DEATH OR SERIOUS ILLNESS AND WHICH ARE KNOWN TO THE STATE OF CALIFORNIA TO CAUSE CANCER, BIRTH DEFECTS OR OTHER REPRODUCTIVE HARM. ALSO, OPERATION, INSTALLATION AND SERVICING OF THIS PRODUCT COULD EXPOSE YOU TO AIRBORN PARTICLES OF GLASS WOOL FIBERS KNOWN TO THE STATE OF CALIFORNIA TO CAUSE CANCER THROUGH INHALATION."

IMPORTANT INFORMATION

The gas fireplace must be installed and serviced by a qualified installer to conform with local codes. In the absence of local codes, install to the current National Fuel Gas Code, ANSI Z223.1 or the current CAN/CGA B149, installation codes.

THE FIREPLACE MUST BE ISOLATED FROM THE GAS SUPPLY PIPING SYSTEM BY CLOSING ITS INDIVIDUAL MANUAL SHUTOFF VALVE DURING ANY PRESSURE TESTING OF THE GAS SUPPLY PIPING SYSTEM AT TEST PRESSURES EQUAL TO OR LESS THAN 1/2 PSIG. PRESSURES IN EXCESS OF 1/2 PSIG WILL CAUSE DAMAGE TO CONTROL VALVE AND MAY CAUSE DAMAGE TO THE SHUTOFF VALVE.

Maximum input is 42,000 BTU/h for both natural and propane gases.

Minimum inlet gas supply pressure is 4.5 inches water column for natural gas and 11 inches water column for propane.

Maximum inlet gas supply pressure is 7.0 inches water column for natural gas and 13.0 inches water column for propane.

Manifold pressure under flow conditions is 3.5 inches water column for natural gas and 10.0 inches water column for propane.

DANGER: DO NOT OPERATE THIS APPLIANCE UNDER ANY CIRCUMSTANCES SHOULD THE AIR TERMINAL BE COVERED TO ANY DEGREE OR IN ANY MANNER SUCH AS BY SNOW, LEAVES OR ANY SUBSTANCE.

- The fireplace is a decorative gas appliance. Do not burn wood or other materials in this fireplace.
- Adults and especially children should be alerted to the hazards of high temperatures and should stay away to avoid burns or clothing ignition.
- Supervise young children when they are in the same room as the fireplace.
- Due to high temperatures, the fireplace should be located out of traffic and away from furniture and draperies.
- Clothing or other flammable material should not be placed on or near the fireplace.
- The fireplace glass door must be in place when the appliance is operating.
- It is imperative that the control compartments, burners and circulating air passage ways of the fireplace and venting system are kept clean. The fireplace and its venting system should be inspected before use and at least annually by a qualified service person. More frequent cleaning may be required due to excessive lint from carpeting, bedding material, etc.
- The fireplace area must be kept clear and free from combustible materials, gasoline and other flammable vapors and liquids.
- This fireplace must not be connected to a chimney flue serving a separate solid fuel burning appliance.
- Under no circumstances should the fireplace be modified.
- The fireplace is not intended for use with a thermostat.
- Do not use this appliance if any part has been under water. Immediately call a qualified service technician to inspect the appliance and replace all parts of the control system and gas controls that has been under water.
- The fireplace is only to be used with the glass door certified with the fireplace.

For Massachusetts Residences Only:

- This product must be installed by a licensed plumber or gas fitter when installed within the Commonwealth of Massachusetts. Flexline installation must not exceed 36 inches.

CONGRATULATIONS!

You have chosen the finest decorative gas appliance available. Your 6-IN-1™ Specialty Gas Fireplace has been designed for years of heating and viewing enjoyment. Please take time to read this entire manual before installing or operating your system.

Parts	
Diagram.....	3
List.....	4
Appliance System Components.....	5
Fireplace Configuration Installation.....	6
Framing Instructions.....	7
Fireplace Installation.....	8
Fireplace Installation and Venting Diagrams.	9
Venting Requirements.....	10
Log Installation.....	11
Wall Switch Installation.....	12
Adjustments and Maintenance.....	13-14
Combustion Air Precautions.....	15
Combustion Air Assembly.....	16
Operating Instructions.....	17-18
Safety Checklist.....	19
Troubleshooting.....	20

LISTING AND CODE APPROVALS

U.S. and Canada Certification

The B Vent Designer Series Gas Appliance has been tested in accordance with the ANSI Z21.50-2007·CSA 2-22-2007 Standard for Vented Gas Fireplaces and have been LISTED by OMNI-Test Laboratories, Inc. for installation and operation described in these installation and Operating Instructions. All components are UL, AGA, CGA or CSA safety certified.

Local Codes

Check with your local building code agency prior to installing this appliance to ensure compliance with local codes, including the need for permits and follow-up inspections. This installation must conform with local codes or, in the absence of local codes, in the USA with the National Fuel Gas Code, ANSI Z223.1 - latest edition.

Your specialty gas fireplace is identified by model number, serial number, and gas type. For your convenience, complete this section for future reference when contacting your dealer.

Model _____ Dealer _____

Serial No. _____ Dealer Phone No. _____

Gas Type: Propane _____ Natural _____ Date of Purchase _____

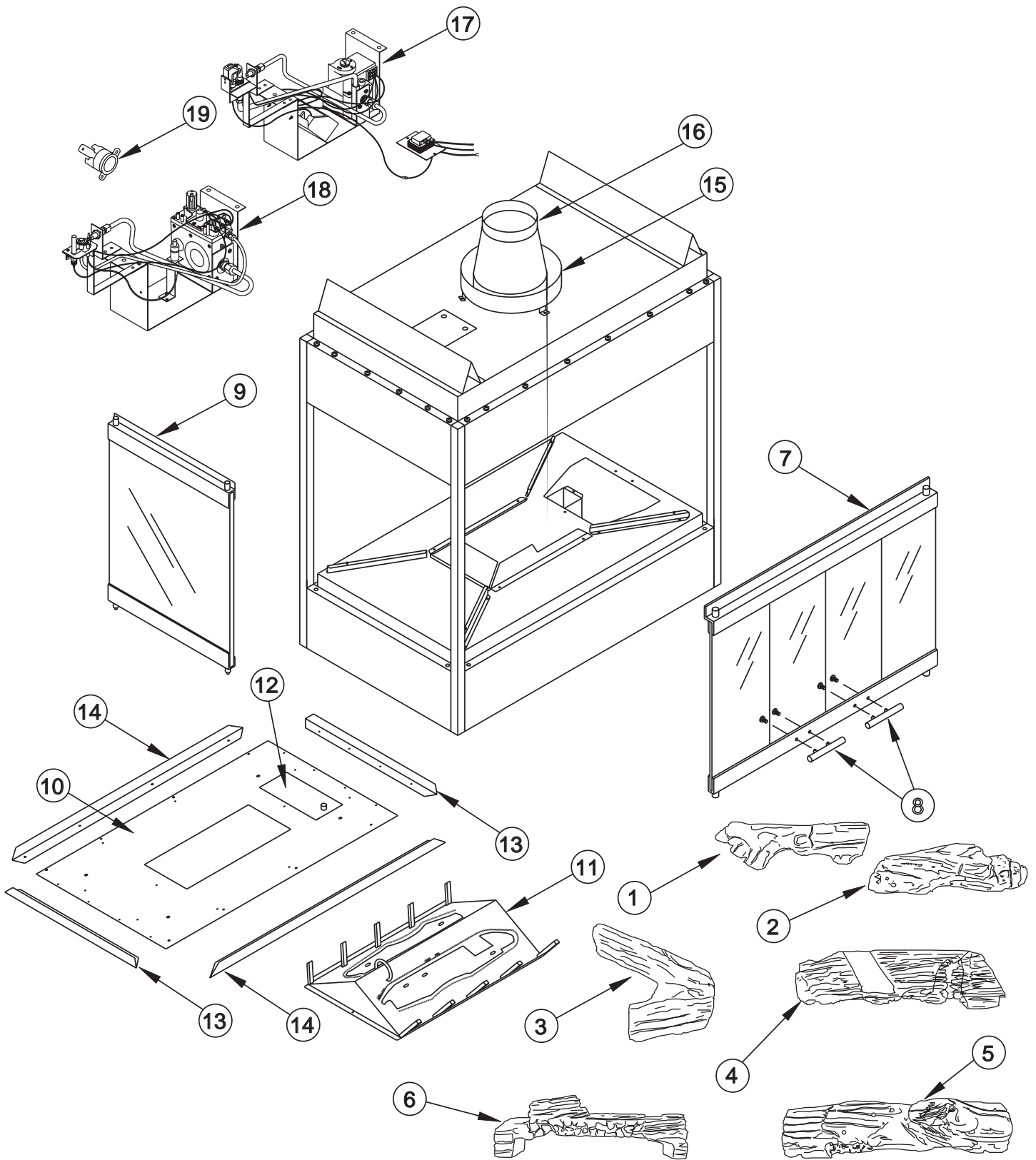

All repair part orders should be placed through your local dealer. To ensure prompt and accurate service, please provide the following information when placing a repair part order: Model number of your Fireplace, Part Name, Part Number, and Quantity of parts needed.

Technical Service Department
2813 W. Mall Drive, Unit B.
Florence, Alabama 35630.
Tel. - 1-866-500-5671
www.monessenhearth.com

6-IN-1 PART LIST

KEY NO.	PART NAME	QTY.	PART NO.
1	TWIG, TOP	1	074270
2	TWIG, END	1	074269
3	TWIG, FRONT Y	1	074268
4	LOG, BACK	1	074266
5	LOG, FRONT	1	074265
6	LOG, MIDDLE	1	074267
7	FRONT DOOR ASSY	2	069484
8	HANDLE PACKAGE	1	037438
9	END DOOR ASSY	2	069485
10	HEARTH PAN PNTD	1	071584
11	BURNER ASSY	1	071459
12	ACCESS PANEL PNTD	1	071585
13	HEARTH PAN EDGE SHORT PNTD	2	071567
14	HEARTH PAN EDGE LONG PNTD	2	071568
15	RADIATION SHIELD ASSY	1	070945
16	TRANSITION SECTION	1	070989
17	GAS CONTROL ASSY E.I.	1	077620
18	GAS CONTROL ASSY NAT	1	076673
19	LIMIT SWITCH	1	071589

The table below is a list of components which may be safely used with this product.

Configuration Kits

6BK	Bay Kit
6CK	Corner Kit (works for left or right side)
6IK	Island Kit
6PNK	Peninsula Kit
6SK	See-Thru Kit

Control Kits

6CN	Control Kit Natural Gas Standing Pilot
6CLP	Control Kit Propane/LP Gas Standing Pilot
6CEN	Control Kit Natural Gas Electronic Ignition

Accessories

GCKDV6E	6CEN LP Conversion Kit
GCK6CLP	6CN LP Conversion Kit
GCK6CN	6CLP Natural Conversion Kit
6AK	Outside Air Kit
6BKB	Back Refractory Look Panel
6BKS	Side Refractory Look Panel
RC2	Hand Held Remote Control

FIGURE 1

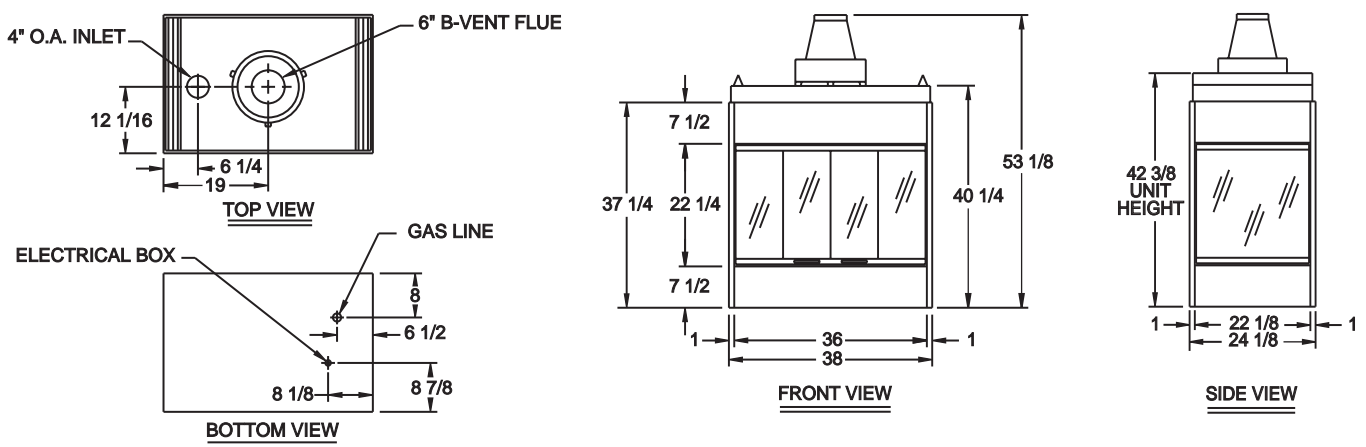

PART 1

Remove front glass door by removing the cardboard fillers at the top and lifting up and away from the appliance.

Install the handles onto the door using screws from the handle package.

Keep front glass door off of the appliance until installation of **Configuration Kit (Part 2)** and **Control Kit (Part 3)** are completed.

Remove carton containing logs. Retain for later installation.

Remove and dispose of the cardboard support for log carton.

Remove burner pan by removing two (2) screws. Replace screws in holes for later use.

Remove the hearth pan that burner was secured to by lifting it up and off of its four (4) locating pins.

PART 2

The appliance is now ready for one of the following configuration kits:

6BK	Bay Kit
6CK	Corner Kit (Does left or right side open.)
6IK	Island Kit
6PNK	Peninsula Kit
6SK	See-Thru Kit

Complete installation instructions are included with each kit.

PART 3

After installing the Configuration Kit (Part 2), the appliance is ready for one of the following control kits:

6CN	Control Kit Natural Gas Standing Pilot
6CLP	Control Kit Propane/LP Gas Standing Pilot
6CEN	Control Kit Natural Gas Electronic Ignition

Complete installation instructions are included with each kit.

Once your Configuration Kit and Control Kit have been installed, install the hearth pan by positioning it down onto the four (4) locating pins, making sure the access panel is positioned over the controls.

The burner may now be installed onto the hearth pan. This is done by positioning the large opening in the burner, over the pilot protruding up from the control panel. Lower the burner around the pilot down onto the firebox bottom.

Looking through the large opening in the burner pan, position the burner tube with air shutter onto the orifice mounted on the control panel.

The burner may now be secured at both ends with screws removed earlier.

Proceed with Installation.

It is best to frame your fireplace after it is positioned and the vent system installed. Use 2x4's and frame to local building codes.

To install the fireplace facing flush with the finished wall, position the framework to accommodate the thickness of the finished wall.

It is not necessary to install a hearth extension with this fireplace system.

The junction box should be wired to the electrical system at the time of installation of the fireplace. Wiring must be performed by a qualified person in a manner to conform with National Electrical Code ANSI/NFPA 70 and all applicable local codes.

CAUTION: ALWAYS CHECK AND MAKE SURE POWER IS OFF BEFORE ATTEMPTING TO INSTALL OR SERVICE ANY ELECTRICAL WIRING OR COMPONENTS.

FIGURE 2

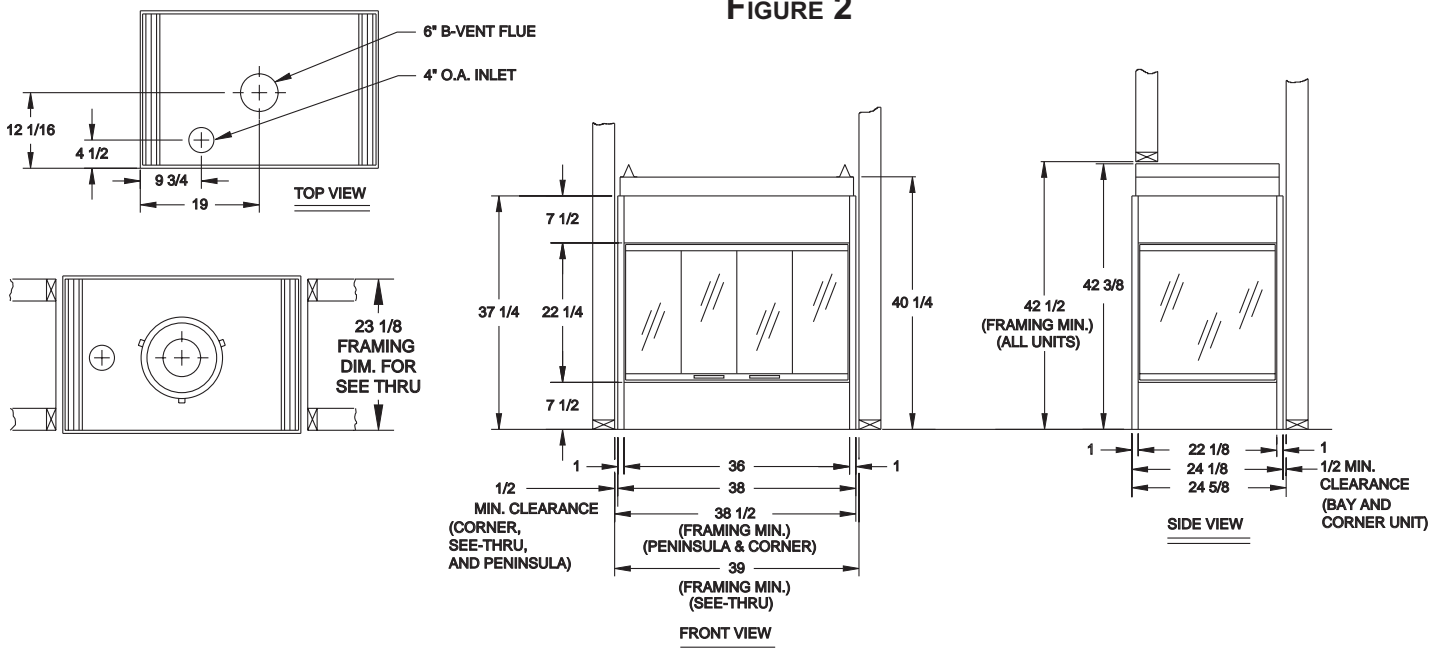

Clearance to Combustible Construction. See Figure 2.

Sides - 1/2 inches

Top - 0 to Top of Spacers

Bottom - 0 inches

Back - 1/2 inches

Front - 37 inches

When the fireplace is installed directly on carpeting, vinyl tile or other combustible material (other than wood flooring) it shall be installed on a metal or wood panel extending the full width and depth of the fireplace.

Provide adequate ventilation air.

Provide adequate accessibility clearance for servicing and operating the fireplace.

Never obstruct the front opening of the fireplace.

To accommodate the various configurations, we have provided access openings in the bottom of the unit for gas line and wall switch wires. This may not be convenient for some installations, if so you may drill an access opening into the lower face of the unit (1" for gas line, 1/2" for the grommet).

1. Route the 3/8 inch N.P.T. black iron gas line or equivalent to the fireplace. Include a manual shut-off valve and union in the line so the control may be disconnected for servicing. A drip leg is also recommended in the gas supply line.
2. Install a rigid black pipe or if local codes permit a 3/8 inch flex connector and shutoff valve to the gas line and the fireplace gas valve. Seal and tighten securely. An adapter fitting is required between the gas valve and flex connector if used. **Do not kink flex connector** (Figure 3).
3. Check for gas leaks with a soap and water solution. Do NOT USE AN OPEN FLAME.

NOTE: PURGE ALL GAS LINES WITH THE GLASS DOOR OF THE FIREPLACE REMOVED. ASSURE THAT A CONTINUOUS GAS FLOW IS AT THE BURNER BEFORE INSTALLING THE DOOR.

FIGURE 3

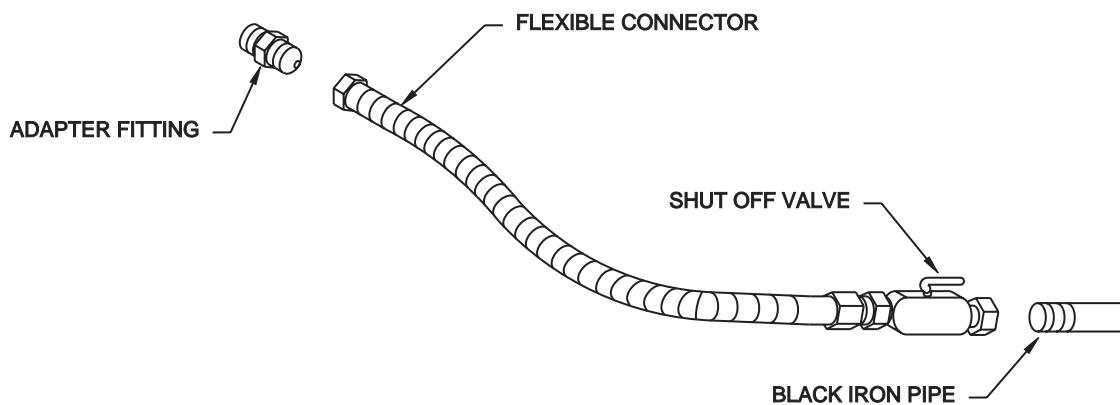

FIGURE 4

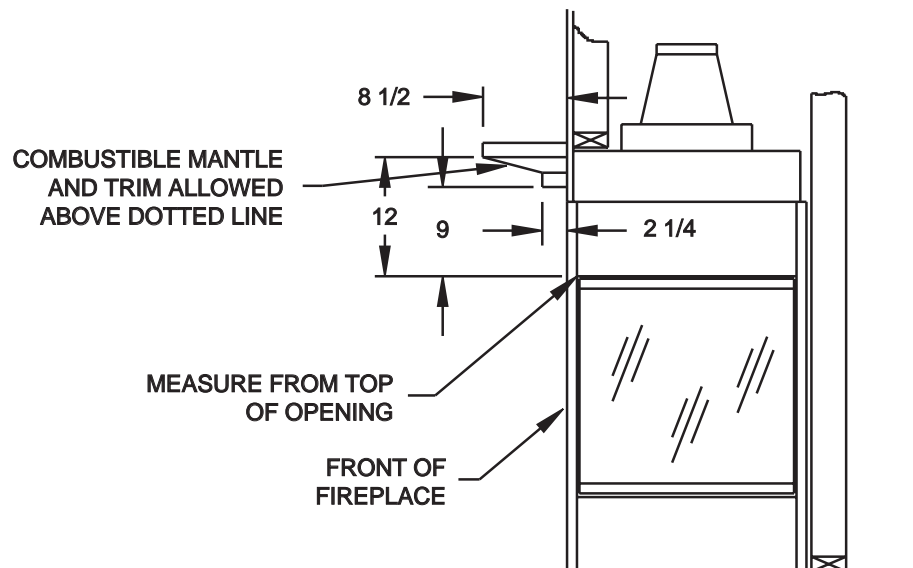

FIGURE 5

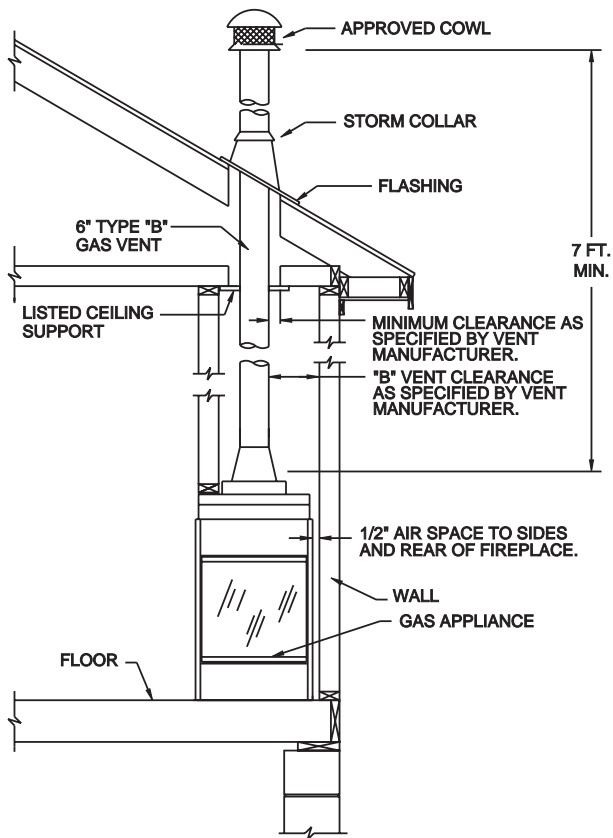

FIGURE 6

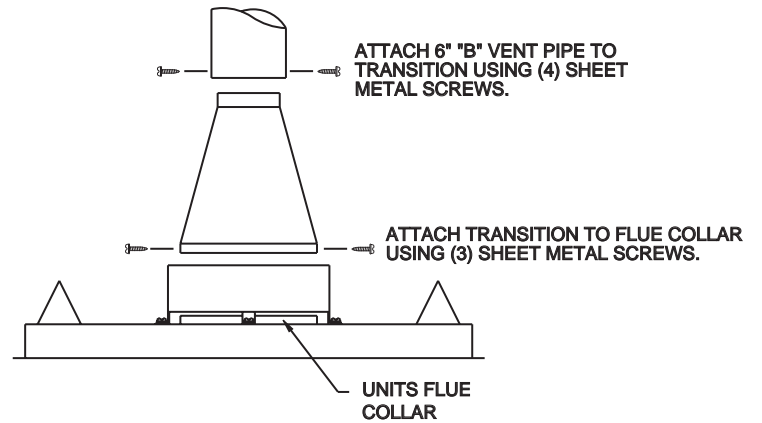
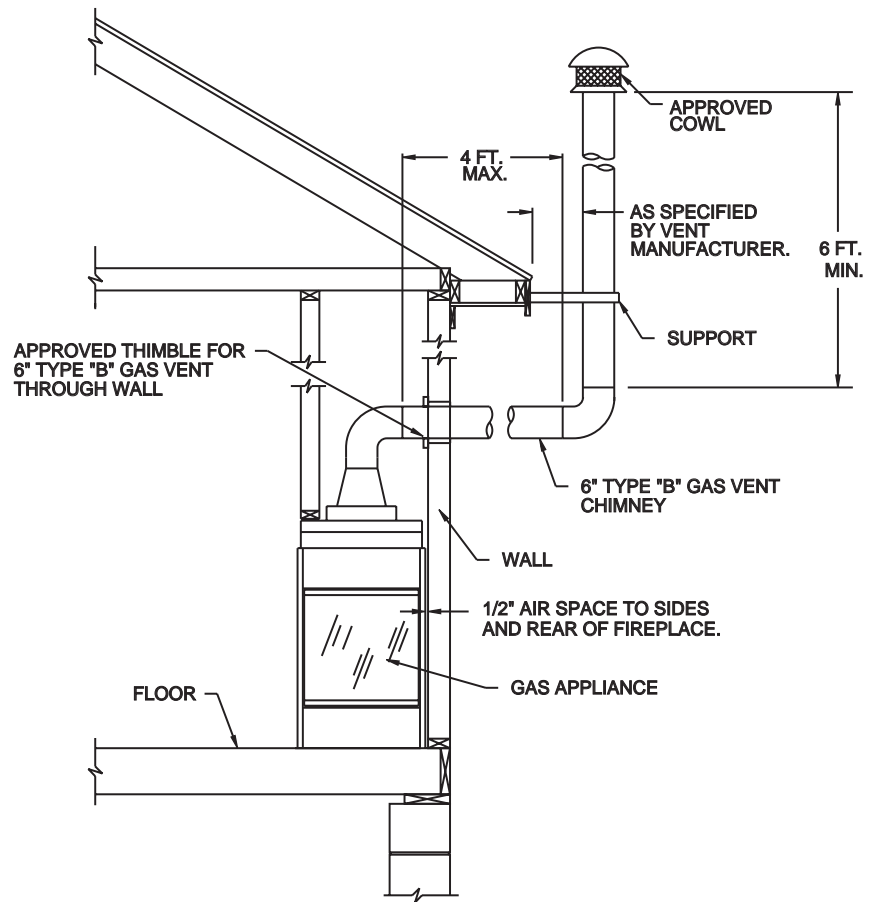

FIGURE 7



WARNING: DO NOT CONNECT THIS APPLIANCE TO A CHIMNEY FLUE SERVING A SEPARATE SOLID FUEL BURNING APPLIANCE. CARBON DEPOSITS (SOOT) AND CREOSOTE FROM SOLID FUELS CAN CLOG THE VENT FROM THE APPLIANCE CAUSING POISONOUS CARBON MONOXIDE TO BE RELEASED INTO THE ROOM IN WHICH THE APPLIANCE IS INSTALLED.

All vented gas-fired appliances when operating correctly produce small concentrations of carbon monoxide along with other combustion products. Should something interfere with the operation of the appliance, it is possible for the appliance to produce deadly quantities of poisonous carbon monoxide. ALL FLUE PRODUCTS FROM THIS APPLIANCE MUST BE VENTED TO THE OUTSIDE AT ALL TIMES. NEVER OPERATE AN APPLIANCE DESIGNED TO BE VENTED WITHOUT A CORRECTLY WORKING VENT SYSTEM CONNECTED TO THE APPLIANCE.

WARNING: VENTING OF THIS APPLIANCE IS ONE OF THE MOST IMPORTANT PARTS OF THE INSTALLATION. VENTING SYSTEMS MUST BE INSTALLED AND INSPECTED ACCORDING TO THESE INSTRUCTIONS AND LOCAL CODES OR IN THE ABSENCE OF LOCAL CODES, ACCORDING TO THE NATIONAL FUEL GAS CODE Z223.1 - LATEST EDITION, BY A LICENSED OR OTHERWISE QUALIFIED INSTALLER.

Your local gas company should have copies of the National Fuel Code Z223.1 or other installation codes applicable to your area.

Venting requirements and accepted methods vary greatly depending on the particular installation. It is impossible to thoroughly define all possible installation circumstances in this manual. The following instructions and illustrations are general guidelines only. ALL VENTING MATERIAL MUST BE INSTALLED ACCORDING TO LOCAL CODES, OR IN THE ABSENCE OF SUCH CODES, ACCORDING TO THE NATIONAL FUEL GAS CODE Z223.1.

WARNING: AN IMPROPERLY VENTED GAS-FIRED APPLIANCE CAN LEAD TO DEATH FROM CARBON MONOXIDE POISONING.

Venting materials are not provided with this appliance and must be purchased separately.

This appliance must be installed using 6" type "B" vent.

NOTE: TRANSITION REQUIRED.

Position logs and twigs onto burner as shown in Figure 8.

FIGURE 8

**TOP VIEW OF
LOGS AND TWIGS.**

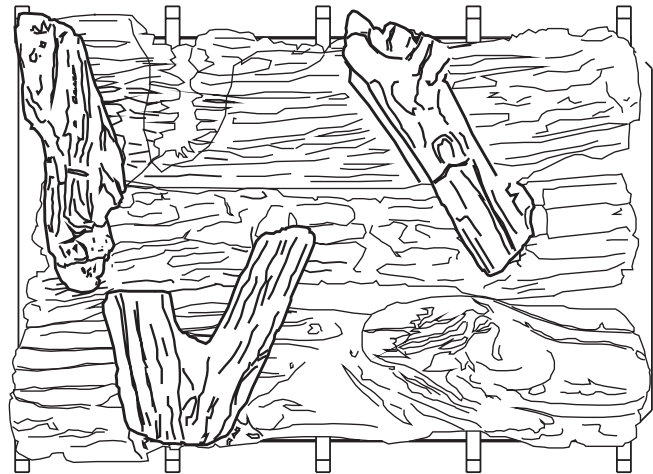

Apply ember material near the grate bars as shown in Figure 9.

FIGURE 9

TOP VIEW - FRONT LOG AND GRATE BARS

TYPICAL BOTH SIDES
FOR PENINSULA AND SEE-THRU CONFIGURATIONS.

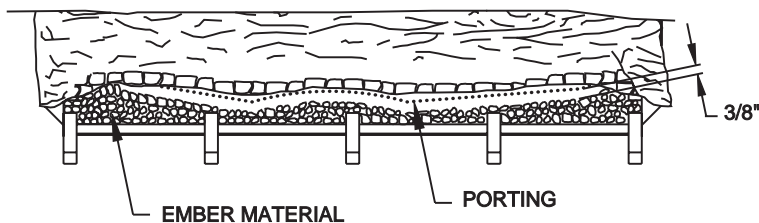

SPECIAL EMBER MATERIAL PROVIDED MAY BE PLACED BETWEEN FRONT PORTING AND GRATE BARS WITH A RECOMMENDED 3/8" SPACING FREE OF EMBER MATERIAL DIRECTLY IN FRONT OF THE FRONT BURNER PORTS AS SHOWN FOR BEST PERFORMANCE AND EFFECT. BLOCKAGE OF THE BURNER PORTS MAY CREATE INCREASED SOOT AND CARBON BUILDUP.

NOTE:
TO FURTHER ENHANCE THE HEARTH LAVA ROCK MATERIAL MAY BE PLACED ON THE HEARTH PAN AREA TO SIMULATE ASHES. LAVA ROCK MUST NOT BE PLACED ON TOP OF THE BURNER. ONLY ROCKWOOD IS PERMITTED IN THE BURNER FLAME.

Curing Instructions

Note: When lit for the first time the fireplace may emit a slight odor for several hours. This is due to the curing and "burn in" of external parts and lubricants used in the manufacturing process. This condition is temporary. Open doors and window to ventilate the room(s) sufficiently.

Units with 6CEN Controls

1. Determine a convenient location within twenty (20) feet and cut a hole large enough to accommodate the wall switch yet be covered with a wall plate. It is not necessary to use a wall box, but one may be used.
2. Route the wire provided through the 1/2 inch black plastic grommet in the unit.
3. Route the wire into the wall box, connect it to the switch, mount the switch and cover.
4. Set the wall switch to "OFF".
5. Light the pilot according to instructions.

FIGURE 10

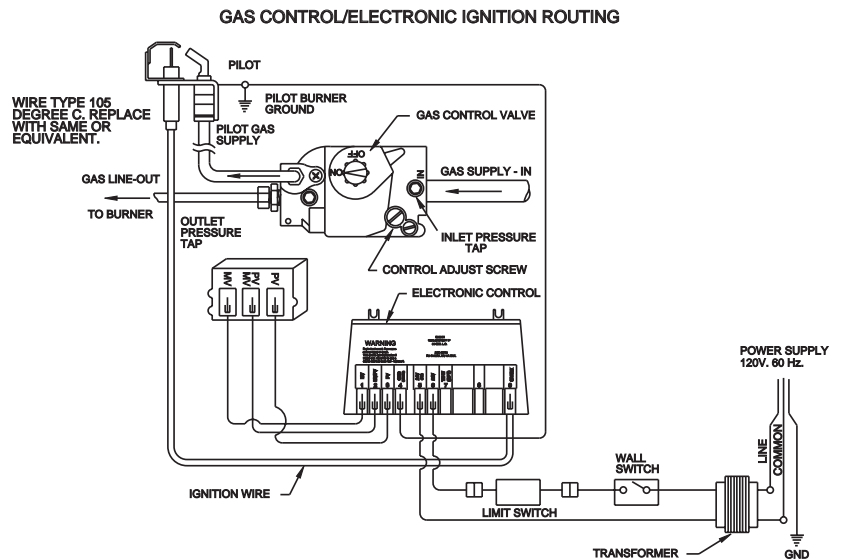

Units with 6CN and 6CLP Controls

The control system on this fireplace is powered by the thermocouple and operates on approximately 500mv (one-half volt). All connections in the wiring must be clean and tight. The wall switch should be located as near the fireplace as practical. Do not locate the wall switch so that more than the 25 feet of wire provided must be used. Additional wire and splices will cause a voltage drop and may cause the control system to not operate.

1. Determine a convenient location within twenty (20) feet and cut a hole large enough to accommodate the wall switch yet be covered with a wall plate. It is not necessary to use a wall box, but one may be used.
2. Route the wire provided through the 1/2 inch black plastic grommet in the unit.
3. Route the wire into the wall box, connect it to the switch, mount the switch and cover.
4. Set the wall switch to "OFF".
5. Light the pilot according to instructions.

FIGURE 11

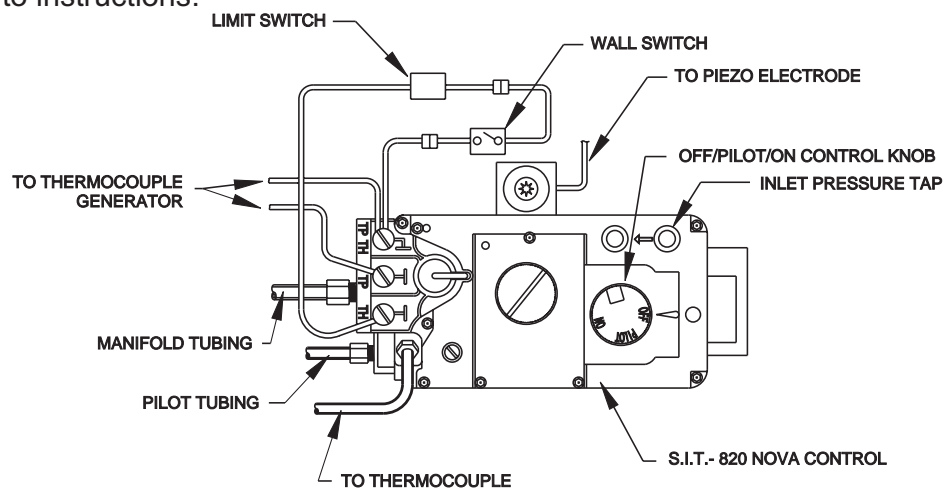

Pilot Burner Adjustment

1. Adjust the pilot screw to provide a properly sized flame.
2. Do not adjust the pilot screw all the way out counterclockwise because it will leak gas.

Flame Switch (For Units with 6CN and 6CLP Controls)

Your fireplace has been equipped with a thermocouple which senses the flame and shuts off the gas flow to the pilot and main burner in the event that the pilot flame is unstable or becomes extinguished.

DANGER: BYPASSING THE THERMOCOUPLE MAY LEAD TO AN EXPLOSION WHICH COULD RESULT IN PERSONAL INJURY.

Do NOT alter the wiring of the control. Replace the thermocouple only with components approved by the manufacturer.

FIGURE 12

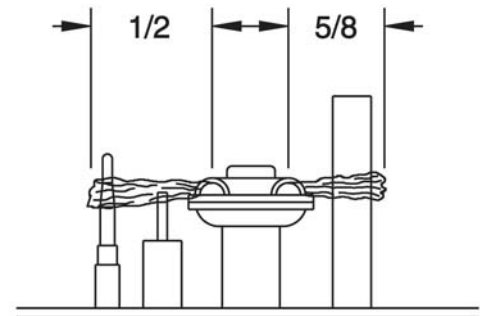

Flame Switch (For Units with 6CEN Controls)

Your fireplace has been equipped with a thermocouple which senses the flame and shuts off the gas flow to the pilot and main burner in the event that the pilot flame is unstable or becomes extinguished.

DANGER: BYPASSING THE THERMOCOUPLE MAY LEAD TO AN EXPLOSION WHICH COULD RESULT IN PERSONAL INJURY.

Do NOT alter the wiring of the control. Replace the thermocouple only with components approved by the manufacturer.

FIGURE 13

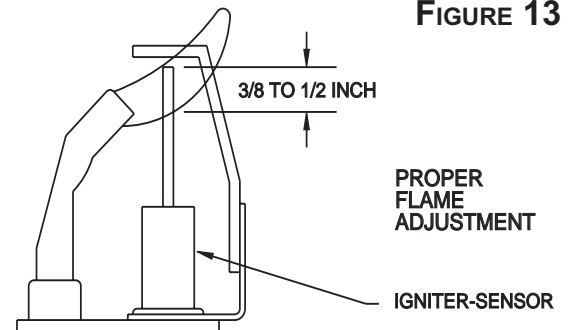

Venturi Adjustment

Natural gas models have a closed shutter. Opening the air shutter will cause a more blue flame, but can cause flame lifting from the burner ports. Propane gas models have an air shutter set at 3/16 (.188) inch open. The same conditions as above apply for propane gas.

NOTE: AIR SHUTTER ADJUSTMENT MUST ONLY BE DONE BY A QUALIFIED GAS INSTALLER.

FIGURE 14

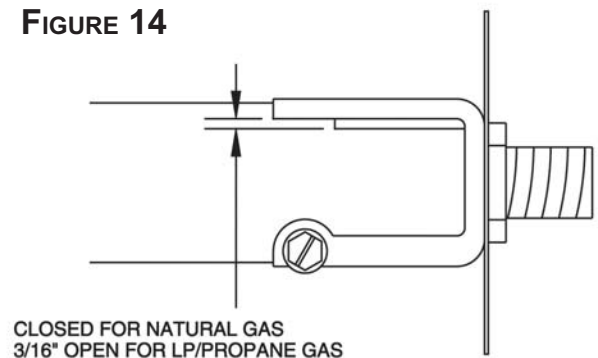

Maintenance of the Appliance

Air flowing through the appliance will cause dust and lint to collect on the grate, burner and logs. Excessive buildup of dust and lint can cause the pilot and burner to operate improperly and produce hazardous levels of carbon monoxide, a poisonous gas. The appliance may produce carbon (soot) during operation. This carbon (soot) may collect on some logs, some areas of the grate and on the fireplace and vent. Slight carbon buildup is acceptable.

The following is a recommended monthly maintenance program:

1. Turn the gas OFF at the line cut-off valve and allow the appliance to cool.
2. Blow or vacuum all dust and lint out of the appliance, paying particular attention to the pilot, air shutter end of the burner, air passage into and through the appliance and control.
3. Vacuum or brush away all dust, carbon or lint on the logs and grate.
4. Turn the gas ON at the line cut-off valve and light the appliance according to the instructions on the chain.
5. Check all piping, pilot tubing, and manifold connections for leaks with a soap and water or liquid leak detecting solution. If any leaks are observed, turn the gas OFF immediately and make the necessary repairs.
6. Light the pilot and visually inspect the flame appearance. Note: Any maintenance of the appliance that requires disconnection of the appliance from the gas line or removal of the control, burner or pilot should only be performed by a qualified person.

NOTE: The use of outside air for combustion is optional unless required by building codes. It is only necessary to supply outside combustion air to one side of the fireplace. Use the model OAC4 combustion air kit.

1. Extremely long runs and numerous turns in the duct leading from the fireplace to the combustion air assembly should be avoided. These conditions will increase the resistance to the free flow of air through the duct. Refer to Figure 9 for methods of installing the outside air for combustion assemblies.
2. The combustion air assembly should be located at an exterior location, which is not likely to be accidentally blocked in any manner. The assembly should be located above the snow line to prevent blockage by snow accumulation.
3. The combustion air inlet assembly should never be mounted in a garage or storage area where combustible fumes such as gasoline might be drawn into the fireplace.
4. Combustion air can be drawn from the crawl space under a house when an adequate supply of air is provided by open ventilation.
5. Do not take combustion air from attic space or garage space.

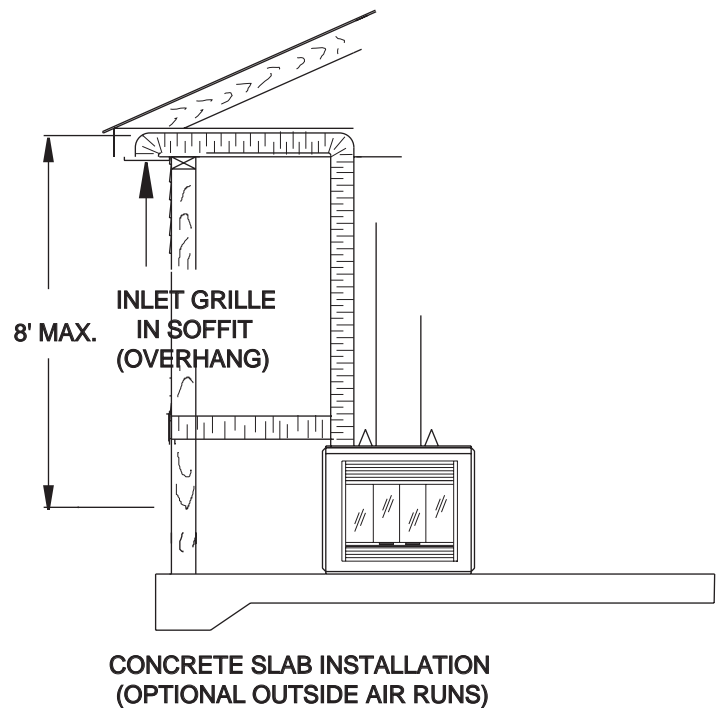
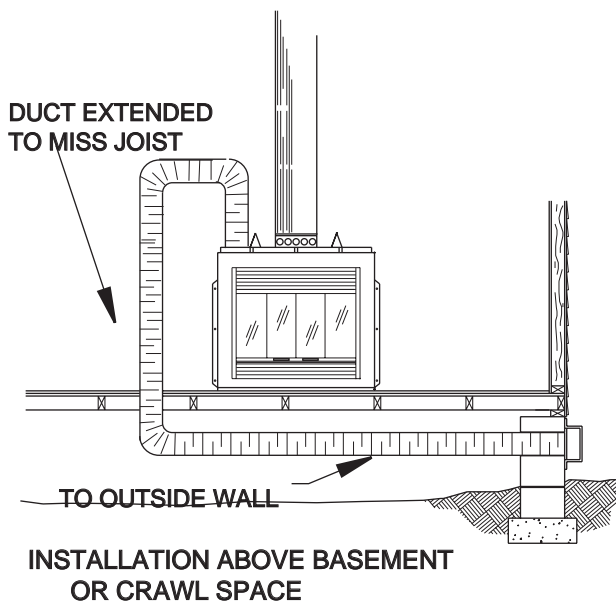

MODEL AK4 COMBUSTION AIR ASSEMBLY

1. Remove the cover plate from the 4-inch outlet opening location on the left outside of the fireplace. **DO NOT** remove the cover if the outside air will not be connected.
2. Place the starting collar (4 inch) into the hole on the left side of the fireplace. Fasten it in place with the four sheet metal screws provided.
3. Cut a 6-inch diameter opening for model AK4 in the outside wall covering where the outside vent is to be located.
4. Select and cut a piece of duct sufficient length to attach to the fireplace and protrude at least three inches beyond the face of the wall to which the inlet air vent will be attached. The duct may be cut with a standard pocket knife (use FP-4 U duct for maximum efficiency and safety). Do not use a combustible duct. Always use UL Listed Class 0 or 1 duct material. If it is necessary to splice the duct, a Model 403 duct connector should be used to splice duct sections.
5. If the duct is the insulated type, push the insulation back from one end of the duct approximately two inches.
6. Slip the exposed end of the duct over the starting collar on the fireplace.
7. Using the sheet metal screws or duct clamps, secure the duct to the starting collar and to the outside vent.
8. Nail or screw the outside vent to the surface of the wall.

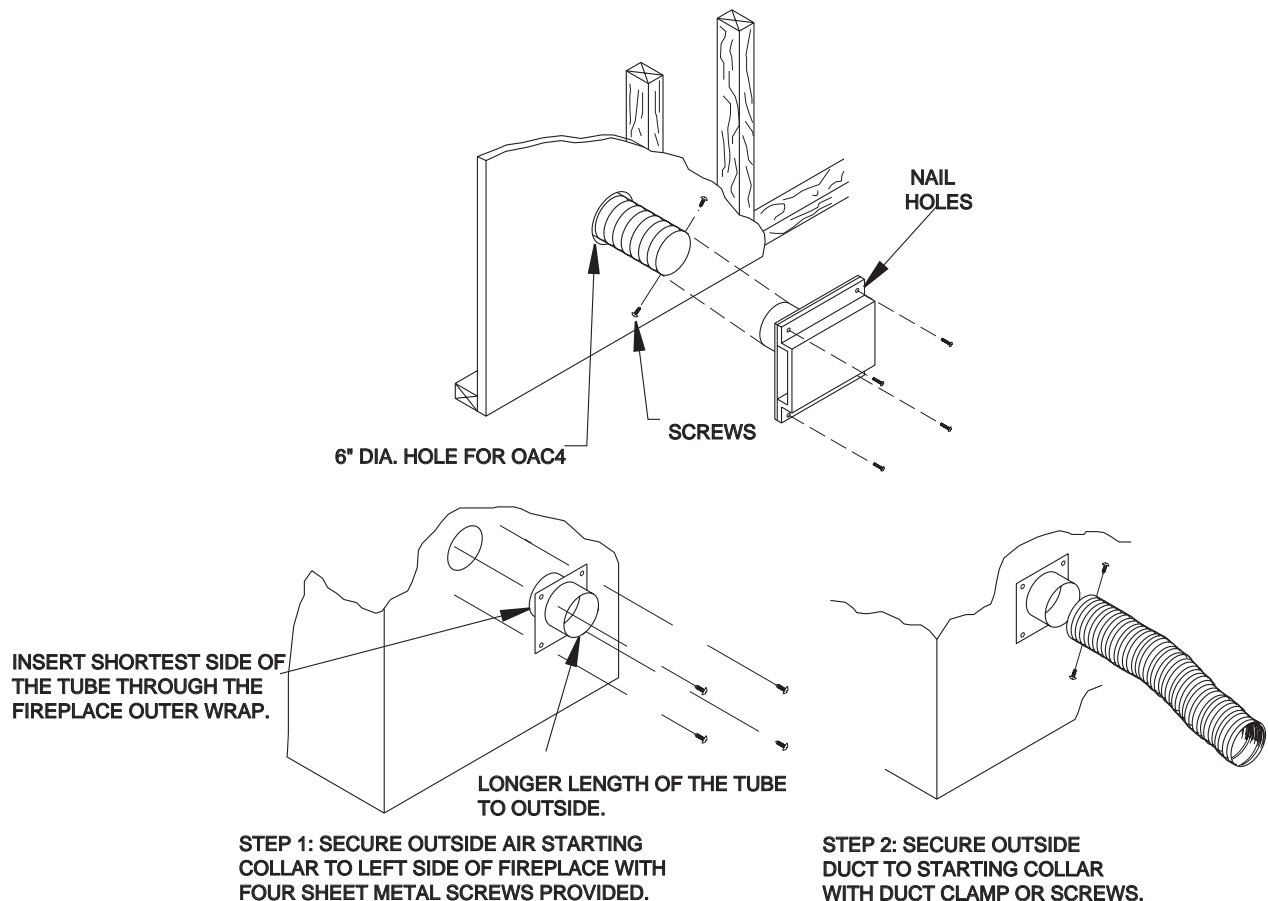

FOR UNITS WITH 6CEN CONTROLS INSTALLED

FOR YOUR SAFETY READ BEFORE LIGHTING



WARNING: IF YOU DO NOT FOLLOW THESE INSTRUCTIONS EXACTLY, A FIRE OR EXPLOSION MAY RESULT CAUSING PROPERTY DAMAGE, PERSONAL INJURY OR LOSS OF LIFE.

- A. THIS APPLIANCE IS EQUIPPED WITH AN IGNITION DEVICE WHICH AUTOMATICALLY LIGHTS THE PILOT. DO NOT TRY TO LIGHT THE PILOT BY HAND.
- B. BEFORE LIGHTING SMELL ALL AROUND THE APPLIANCE AREA FOR GAS AND NEXT TO THE FLOOR BECAUSE SOME GAS IS HEAVIER THAN AIR AND WILL SETTLE ON THE FLOOR.
WHAT TO DO IF YOU SMELL GAS
- DO NOT TRY TO LIGHT ANY APPLIANCE.
 - DO NOT TOUCH ANY ELECTRIC SWITCH; DO NOT USE ANY PHONE IN YOUR BUILDING.
 - IMMEDIATELY CALL YOUR GAS SUPPLIER FROM A NEIGHBOR'S PHONE. FOLLOW THE GAS SUPPLIER'S INSTRUCTIONS.
- IF YOU CANNOT REACH YOUR GAS SUPPLIER, CALL THE FIRE DEPARTMENT.
- C. USE ONLY YOUR HAND TO PUSH IN OR TURN THE GAS CONTROL KNOB. NEVER USE TOOLS. IF THE KNOB WILL NOT PUSH IN OR TURN BY HAND, DO NOT TRY TO REPAIR IT. CALL A QUALIFIED SERVICE TECHNICIAN. FORCE OR ATTEMPTED REPAIR MAY RESULT IN A FIRE OR EXPLOSION.
- D. DO NOT USE THIS APPLIANCE IF ANY PART HAS BEEN UNDER WATER. IMMEDIATELY CALL A QUALIFIED SERVICE TECHNICIAN TO INSPECT THE APPLIANCE AND REPLACE ANY PART OF THE CONTROL SYSTEM AND ANY GAS CONTROL WHICH HAS BEEN UNDER WATER.

OPERATING INSTRUCTIONS

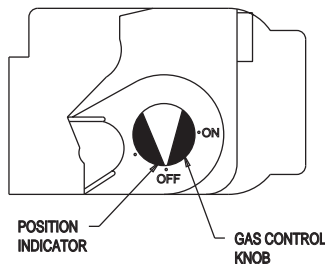
1. STOP! READ THE SAFETY INFORMATION ABOVE ON THIS LABEL.
2. SET THE ROCKER SWITCH TO "OFF".
3. TURN OFF THE ELECTRIC POWER TO THE APPLIANCE.
4. THIS APPLIANCE IS EQUIPPED WITH AN IGNITION DEVICE WHICH AUTOMATICALLY LIGHTS THE PILOT. DO NOT TRY TO LIGHT THE PILOT BY HAND.



5. REMOVE CONTROL ACCESS PANEL.
6. TURN GAS CONTROL KNOB CLOCKWISE  TO "OFF".
7. WAIT FIVE (5) MINUTES TO CLEAR OUT ANY GAS. IF YOU THEN SMELL GAS, STOP! FOLLOW "B" IN THE SAFETY INFORMATION ABOVE ON THIS LABEL. IF YOU DON'T SMELL GAS, GO TO NEXT STEP.
8. TURN GAS CONTROL KNOB COUNTERCLOCKWISE  TO "ON".
9. REPLACE CONTROL ACCESS PANEL.
10. TURN ON ALL ELECTRICAL POWER TO THE APPLIANCE.
11. SET THE ROCKER SWITCH TO "ON".
12. IF THE APPLIANCE WILL NOT OPERATE, FOLLOW THE INSTRUCTIONS "TO TURN OFF GAS TO APPLIANCE" AND CALL YOUR SERVICE TECHNICIAN OR GAS SUPPLIER.

TO TURN OFF GAS TO APPLIANCE

1. SET THE ROCKER SWITCH OR WALL SWITCH TO "OFF".
2. REMOVE CONTROL ACCESS PANEL.
3. DEPRESS THE CONTROL KNOB INWARD SLIGHTLY AND TURN CLOCKWISE  TO OFF.
4. REPLACE CONTROL ACCESS PANEL.
5. IF THE APPLIANCE IS EQUIPPED WITH AN AUTOMATIC IGNITION DEVICE OR OPTIONAL BLOWER, TURN OFF ALL ELECTRICAL POWER TO THE APPLIANCE IF SERVICE IS TO BE PERFORMED.

068059

FOR UNITS WITH 6CN AND 6CLP CONTROLS INSTALLED

FOR YOUR SAFETY READ BEFORE LIGHTING

WARNING: IF YOU DO NOT FOLLOW THESE INSTRUCTIONS EXACTLY, A FIRE OR EXPLOSION MAY RESULT CAUSING PROPERTY DAMAGE, PERSONAL INJURY OR LOSS OF LIFE.

- A. THIS APPLIANCE HAS A PILOT WHICH MUST BE LIT BY HAND WHILE FOLLOWING THESE INSTRUCTIONS EXACTLY.
- B. BEFORE LIGHTING SMELL ALL AROUND THE APPLIANCE AREA FOR GAS AND NEXT TO THE FLOOR BECAUSE SOME GAS IS HEAVIER THAN AIR AND WILL SETTLE ON THE FLOOR.
 - WHAT TO DO IF YOU SMELL GAS
 - DO NOT TRY TO LIGHT ANY APPLIANCE.
 - DO NOT TOUCH ANY ELECTRIC SWITCH; DO NOT USE ANY PHONE IN YOUR BUILDING.
 - IMMEDIATELY CALL YOUR GAS SUPPLIER FROM A NEIGHBOR'S PHONE. FOLLOW THE GAS SUPPLIER'S INSTRUCTIONS.
- IF YOU CANNOT REACH YOUR GAS SUPPLIER, CALL THE FIRE DEPARTMENT.
- C. USE ONLY YOUR HAND TO PUSH IN OR TURN THE GAS CONTROL KNOB. NEVER USE TOOLS. IF THE KNOB WILL NOT PUSH IN OR TURN BY HAND, DO NOT TRY TO REPAIR IT. CALL A QUALIFIED SERVICE TECHNICIAN. FORCE OR ATTEMPTED REPAIR MAY RESULT IN A FIRE OR EXPLOSION.
- D. DO NOT USE THIS APPLIANCE IF ANY PART HAS BEEN UNDER WATER. IMMEDIATELY CALL A QUALIFIED SERVICE TECHNICIAN TO INSPECT THE APPLIANCE AND REPLACE ANY PART OF THE CONTROL SYSTEM AND ANY GAS CONTROL WHICH HAS BEEN UNDER WATER.

LIGHTING INSTRUCTIONS

WHEN LIGHTING AND RELIGHTING, THE GAS KNOB CANNOT BE TURNED FROM PILOT TO OFF UNLESS THE KNOB IS DEPRESSED.

1. STOP! READ THE SAFETY INFORMATION ON THE FIRST LABEL.
2. TURN OFF ALL ELECTRICAL POWER TO THE APPLIANCE.
3. TURN GAS KNOB CLOCKWISE  TO OFF.

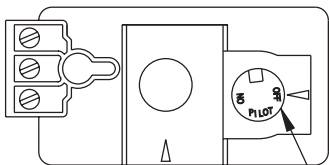



GAS KNOB "OFF"

4. WAIT FIVE (5) MINUTES TO CLEAR OUT ANY GAS. THEN SMELL FOR GAS, INCLUDING NEAR THE FLOOR. IF YOU SMELL GAS, STOP! FOLLOW "B" IN THE SAFETY INFORMATION ON THE FIRST LABEL. IF YOU DON'T SMELL GAS GO TO THE NEXT STEP.

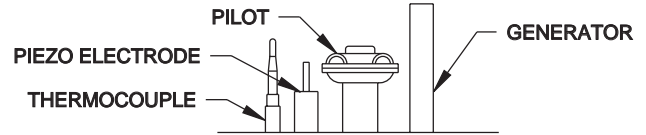
5. IF APPLIANCE IS EQUIPPED WITH HI-LO ADJUSTMENT VALVE TURN COUNTERCLOCKWISE  TO HIGH.
6. FIND PILOT LOCATED IN FRONT OF THE MIDDLE LOG.



7. TURN GAS KNOB COUNTERCLOCKWISE  TO PILOT.
8. DEPRESS AND HOLD GAS KNOB WHILE LIGHTING THE PILOT WITH THE PUSH BUTTON IGNITOR. KEEP KNOB FULLY DEPRESSED FOR ONE MINUTE, THEN RELEASE. IF PILOT DOES NOT CONTINUE TO BURN REPEAT STEPS 3 THRU 7.
9. WITH PILOT LIT TURN GAS KNOB COUNTERCLOCKWISE  TO ON.
10. IF EQUIPPED WITH REMOTE ON-OFF SWITCH MAIN BURNER MAY NOT COME ON WHEN YOU TURN THE VALVE TO ON OR HIGH. REMOTE SWITCH MUST BE IN THE ON POSITION TO IGNITE BURNER.
11. TURN ON ALL ELECTRICAL POWER TO THE APPLIANCE.

TO TURN OFF GAS TO APPLIANCE

1. TURN OFF ALL ELECTRICAL POWER TO THE APPLIANCE IF SERVICE IS TO BE PERFORMED.
2. PUSH IN GAS CONTROL KNOB SLIGHTLY AND TURN CLOCKWISE  TO OFF. DO NOT FORCE.

068058

Correct installation and safe operation of this appliance require, but are not limited to the following:

Do's:

1. Do use this appliance only on type of gas it is designed, certified and equipped.
2. Do install this appliance and all gas piping according to local codes, or in the absence of local codes, according to the current National Fuel Gas Code, ANSI Z223.1 latest edition.
3. Do disconnect or isolate the appliance during supply line pressure testing.
4. Do locate the appliance out of traffic patterns as much as possible.
5. Do keep in mind that some furniture materials such as vinyl or plastic may deform at the temperatures near this appliance and must be kept at greater distances.
6. Do use joint compound (pipe dope) on threaded joints of gas piping that is resistant to the action of liquified petroleum gas.
7. Do include a manual shutoff valve and union ahead of the controls so that the controls and appliance may be removed for servicing if necessary.
8. Do use only ground joint unions in gas piping.
9. Do include a drip leg in the gas supply connection to the appliance.
10. Do use only soap-water solution or liquid gas leak solution when checking for leaks in the gas plumbing. Never use matches, candles or other ignition sources when checking for leaks.
11. Do connect the appliance only to an agency listed vent system.
12. Do adjust the air shutter as required to produce the proper flame as described in this manual.
13. Do keep the area around the appliance clear and free from combustible materials, gasoline and other flammable vapors and liquids.
14. Do follow the lighting and operation procedures given in this manual.
15. Do periodically inspect the pilot and burner flame as described in the maintenance section of this manual.
16. Do clean the appliance as specified in the maintenance section of this manual.
17. Do provide electrical grounding of appliance in accordance with local codes and/or the National Electric Code ANSI NFPA 70 latest edition.
18. Do inspect the entire venting system at least once a year and replace all parts that show evidence of damage or deterioration.

Don'ts

1. Don't modify or alter the appliance cabinet (jacket) in any way.
2. Don't use this appliance on any gas other than the type for which it is equipped. The type of gas for which the appliance was equipped at the factory is stamped on the rating plate located on the bottom of the appliance.
3. Don't install the appliance in areas where gasoline or any flammable liquid or any explosive materials may be used or stored.
4. Don't obstruct the flow of air for combustion and ventilation into or away from the appliance at any time.
5. Don't use this appliance if any part has been underwater. Immediately call a qualified service technician to inspect the appliance and to replace any part of the control system and any gas control which has been under water.
6. Don't operate this appliance without proper electrical grounding according to local codes or the National Electric Code ANSI NFPA 70 latest edition.
7. Don't operate this appliance without a proper vent.
8. Don't connect this appliance to a chimney flue serving a solid fuel burning appliance.
9. Don't use thermostats or automatic burner cycling devices.

While the manufacturer has made every reasonable effort to ensure that this appliance operates properly and satisfactorily, sometimes problems do arise. The following troubleshooting chart lists several problems with their probable cause and remedy. Any adjustments and/or replacements must be by a qualified person. Do not replace any component with a different type. Use only components supplied by the manufacturer for this appliance.

Trouble	Probable Cause	Remedy
Flame too Large	<ol style="list-style-type: none"> 1. Pressure Regulator Set too Hi 2. Defective Regulator 3. Burner Orifice too Large 	<ol style="list-style-type: none"> 1. Reset, Using Manometer 2. Replace 3. Replace with Correct Size
Noisy Flame	<ol style="list-style-type: none"> 1. Too Much Primary Air 2. Noisy Pilot 3. Burr in Orifice 	<ol style="list-style-type: none"> 1. Adjust Air Shutters 2. Reduce Pilot Gas 3. Remove Burr or Replace
Yellow or Excessive Flame	<ol style="list-style-type: none"> 1. Too Little Primary Air 2. Clogged Burner Ports 3. Misaligned Orifices 4. Clogged Vent System 	<ol style="list-style-type: none"> 1. Adjust Air Shutters 2. Clean Ports 3. Realigned or Replace Burner 4. Clean
Floating Flame	<ol style="list-style-type: none"> 1. Blocked Venting 2. Insufficient Primary Air 	<ol style="list-style-type: none"> 1. Clean 2. Adjust Air Shutter
Delayed Ignition	<ol style="list-style-type: none"> 1. Improper Pilot Location 2. Pilot Flame too Small 3. Burner Ports Clogged 4. Low Pressure 	<ol style="list-style-type: none"> 1. Reposition Pilot 2. Check Orifice, Increase Gas 3. Clean Ports 4. Adjust Pressure Regulator
Failure to Ignite	<ol style="list-style-type: none"> 1. Main Gas Off 2. Defect in Gas Valve 	<ol style="list-style-type: none"> 1. Open Manual Valve 2. Replace
Burner Won't Turn Off	<ol style="list-style-type: none"> 1. Defective Auto Valve 	<ol style="list-style-type: none"> 1. Clean or Replace
Burner Won't Turn On	<ol style="list-style-type: none"> 1. Defective Auto Valve 2. Defective Thermocouple 3. Defective Switch 4. Defective Auto Pilot Valve 	<ol style="list-style-type: none"> 1. Replace 2. Replace 3. Repair or Replace 4. Replace
Burner & Pilot Flame Go Out	<ol style="list-style-type: none"> 1. Poorly Functioning Vent System 2. Gas Supply Interrupted 3. Defective Thermocouple or Control 	<ol style="list-style-type: none"> 1. If Pilot can be Relit but Main Burner & Pilot Go Off After Ignition, Have Vent System Checked and Corrected Immediately. 2. Try Relighting Pilot and Main Burner. If Pilot won't Relight, Check Thermocouple & Control 3. Replace

MASSACHUSETTS RESIDENTS ONLY: PLEASE READ AND FOLLOW THESE SPECIAL REQUIREMENTS

NOTE REGARDING VENTED PRODUCTS

This product must be installed by a licensed plumber or gas fitter when installed within the Commonwealth of Massachusetts.

Any residence with a direct vent product must have a CO detector installed in the residence.

Installation of the fireplace or vented gas log in the State of Massachusetts requires the damper to be permanently removed or welded in the fully open position.

In addition, a naturally vented gas log may not be installed in a bedroom or bathroom in the State of Massachusetts.

Flex line installation must not exceed 36 inches and must have a T shutoff valve.

NOTE REGARDING VENT FREE PRODUCTS

This product must be installed by a licensed plumber or gas fitter when installed within the Commonwealth of Massachusetts.

In addition, vent free products may not be installed in a bedroom or bathroom regardless of size or type in the State of Massachusetts.

Flex line installation must not exceed 36 inches and must have a T shutoff valve.

CARBON MONOXIDE DETECTOR REQUIREMENTS

(2) Revise 10.8.3 by adding the following additional requirements:

(a) For all side wall horizontally vented gas fueled equipment installed in every dwelling, building or structure used in whole or in part for residential purposes, including those owned or operated by the Commonwealth and where the side wall exhaust vent termination is less than seven (7) feet above finished grade in the area of the venting, including but not limited to decks and porches, the following requirements shall be satisfied:

1. **INSTALLATION OF CARBON MONOXIDE DETECTORS.** At the time of installation of the side wall horizontal vented gas fueled equipment, the installing plumber or gasfitter shall observe that a hard wired carbon monoxide detector with an alarm and battery back-up is installed on the floor level where the gas equipment is to be installed. In addition, the installing plumber or gasfitter shall observe that a battery operated or hard wired carbon monoxide detector with an alarm is installed on each additional level of the dwelling, building or structure served by the side wall horizontal vented gas fueled equipment. It shall be the responsibility of the property owner to secure the services of qualified licensed professionals for the installation of hard wired carbon monoxide detectors
 - a. In the event that the side wall horizontally vented gas fueled equipment is installed in a crawl space or an attic, the hard wired carbon monoxide detector with alarm and battery back-up may be installed on the next adjacent floor level.
 - b. In the event that the requirements of this subdivision can not be met at the time of completion of installation, the owner shall have a period of thirty (30) days to comply with the above requirements; provided, however, that during said thirty (30) day period, a battery operated carbon monoxide detector with an alarm shall be installed.
-

SPECIAL REQUIREMENTS CONTINUED

2. APPROVED CARBON MONOXIDE DETECTORS. Each carbon monoxide detector as required in accordance with the above provisions shall comply with NFPA 720 and be ANSI/UL 2034 listed and IAS certified.
 3. SIGNAGE. A metal or plastic identification plate shall be permanently mounted to the exterior of the building at a minimum height of eight (8) feet above grade directly in line with the exhaust vent terminal for the horizontally vented gas fueled heating appliance or equipment. The sign shall read, in print size no less than one-half (1/2) inch in size, **“GAS VENT DIRECTLY BELOW. KEEP CLEAR OF ALL OBSTRUCTIONS.”**
 4. INSPECTION. The state or local gas inspector of the side wall horizontally vented gas fueled equipment shall not approve the installation unless, upon inspection, the inspector observes carbon monoxide detectors and signage installed in accordance with the provisions of 248 CMR 5.08(2)(a)1 through 4.
- (b) EXEMPTIONS: The following equipment is exempt from 248 CMR 5.08(2)(a)1 through 4:
1. The equipment listed in Chapter 10 entitled “Equipment Not Required To Be Vented” in the most current edition of NFPA 54 as adopted by the Board; and
 2. Product Approved side wall horizontally vented gas fueled equipment installed in a room or structure separate from the dwelling, building or structure used in whole or in part for residential purposes.
- (c) MANUFACTURER REQUIREMENTS - GAS EQUIPMENT VENTING SYSTEM PROVIDED. When the manufacturer of Product Approved side wall horizontally vented gas equipment provides a venting system design or venting system components with the equipment, the instructions provided by the manufacturer for installation of the equipment and the venting system shall include:
1. Detailed instructions for the installation of the venting system design or the venting system components; and
 2. A complete parts list for the venting system design or venting system.
- (d) MANUFACTURER REQUIREMENTS - GAS EQUIPMENT VENTING SYSTEM NOT PROVIDED. When the manufacturer of a Product Approved side wall horizontally vented gas fueled equipment does not provide the parts for venting the flue gases, but identifies “special venting systems,” the following requirements shall be satisfied by the manufacturer:
1. The referenced “special venting system” instructions shall be included with the appliance or equipment installation instructions; and
 2. The “special venting systems” shall be Product Approved by the Board, and the instructions for that system shall include a parts list and detailed installation instructions.
- (e) A copy of all installation instructions for all Product Approved side wall horizontally vented gas fueled equipment, all venting instructions, all parts lists for venting instructions, and/or all venting design instructions shall remain with the appliance or equipment at the completion of the installation.
-

ATTENTION

**APPLIANCE
INSTALLER**

**PLEASE RETURN THESE OPERATING
AND INSTALLATION INSTRUCTIONS
TO THE APPLIANCE FOR
CONSUMER USE.**