

This Owner's Manual is provided and hosted by [Appliance Factory Parts](#).



Landmann 3425GW Owner's Manual

[Shop genuine replacement parts for Landmann
3425GW](#)



[Find Your Landmann Grill Parts - Select From 200 Models](#)

----- Manual continues below -----



Assembly and Owner's Manual

3425GW/3495GW 3425BGW/3495BGW VERTICAL GAS SMOKER



ASSEMBLER / INSTALLER:

Leave these instructions with the consumer.

CONSUMER / USER:

This instruction manual contains important information necessary for the proper assembly and safe use of this appliance. Read and follow all warnings and instructions before assembling and using this appliance. Follow all warnings and instructions when using this appliance. Keep this manual for future reference.

DANGER:

If you smell gas:

1. Shut off gas to the appliance.
2. Extinguish any open flame.
3. Open door.
4. If odor continues, keep away from the appliance and immediately call your fire department. If a fire should occur, keep away from the appliance and call your fire department. Do not attempt to extinguish an oil or grease fire with water.

DANGER:

1. Never operate this appliance unattended.
2. Never operate this appliance within 10 feet (3.05M) of any other gas cylinder.
3. Never operate this appliance within 25 feet (7.5m) of any flammable liquid.

Failure to follow these instruction could result in fire, explosion or burn hazard, which could cause property damage, personal injury or death.

STATEMENT OF COMMITMENT

Congratulations and thank you for your purchase of our Great Outdoors Smoky Mountain Smoker. We are pleased that you have recognized the value of the design, function and quality of components used in the product.

We are committed to producing quality products that your family will enjoy for years to come. If for any reason we have failed to meet or exceed your expectations, please allow us the opportunity to make it right by calling us toll free at:

1-800-321-3473

between the hours 8:00am and 5:00pm, EST, Monday through Friday

We want you to be completely satisfied with your purchase.

For your future records, please fill in:

Model # _____

Serial # _____

Date of Purchase: _____

Place of Purchase: _____

 LANDMANN

Landmann USA, Inc.
101 Old Mill Road, Building 300
Cartersville, Georgia 30120

Service Note:

If you are experiencing difficulties or are dissatisfied with your purchase, please contact Landmann at the telephone number listed above prior to returning your product to the store.





















For more information about growing family of Smokers, Grills, Fire Pits, Firewood Storage and Fireplace Accessories, please visit our website:

[www. landmann-usa.com](http://www.landmann-usa.com)















READ ALL INSTRUCTIONS AND WARNINGS!

YOUR SAFETY IS VERY IMPORTANT - FAILURE TO FOLLOW PROPER PROCEDURES AND SAFEGUARDS MAY RESULT IN PERSONAL INJURY OR PROPERTY DAMAGE.

WARNING

-  **DO NOT use this smoker in a manner other than its intended purpose. It is not intended for commercial use. It is NOT intended to be installed or used in or on a recreational vehicle and/or boats. The smoker is not to be used as a heater.**
-  **Keep a fire extinguisher accessible at all times.**
-  **The use of alcohol, prescription or non-prescription drugs may impair the user's ability to properly assemble or safely operate the smoker.**
-  **This smoker is for outdoor use only, in a well-ventilated area. DO NOT operate the smoker indoors, in a garage, or in any other enclosed area or under overhead construction.**
-  **Use caution when assembling and operating the smoker to avoid cuts and scrapes from rough or sharp edges.**
-  **Use caution when lifting and moving the smoker to avoid strains or back injury. Two (2) people are recommended to lift or move the smoker. DO NOT move the smoker while it is in use.**
-  **DO NOT operate the smoker near or under flammable or combustible materials such as decks, porches or carports. The minimum clearance shall be at least 24 inches (6.1cm) from any structure or combustible material. DO NOT operate the smoker under overhead construction.**
-  **Keep the fuel supply hose away from any heated surface.**
-  **Operate the smoker only on stable, level, non-flammable surfaces such as asphalt, concrete or solid ground. DO NOT operate the smoker on flammable material such as carpet or a wood deck.**
-  **DO NOT store the smoker near gasoline or other combustible liquids or where combustible vapors may be present.**
-  **DO NOT store or operate the smoker in an area accessible to children or pets. Store the smoker in a dry, protected location.**
-  **DO NOT leave the smoker unattended while it is in use. Operate the smoker with close supervision.**
-  **DO NOT allow anyone to conduct activities around the smoker during or following its use until it has cooled. It is hot during operation and remains hot for a period of time following use.**
-  **DO NOT leave hot ashes unattended until the smoker cools completely.**
-  **DO NOT move the smoker while it is in use. Allow the smoker to cool completely before moving or storing.**
-  **This smoker becomes extremely hot - allow the smoker to cool completely before handling. If you must handle the smoker while it is hot, ALWAYS wear protective oven mitts or heat-resistant gloves when handling the smoker or its components.**
-  **Never use gasoline or other highly volatile fluids as a starter. They can EXPLODE!**
-  **The water pan and wood chip box should not be removed while the smoker is operating or until the smoker has cooled sufficiently. These contain hot liquid and hot ashes that may cause serious injury. If you must move these components, ALWAYS wear protective oven mitts or heat-resistant gloves.**
-  **Dispose of cold ashes by wrapping them in heavy aluminum foil and putting them in a non-combustible container. Be sure there are no other combustible materials in or near the container.**
-  **If you must dispose of the ashes in less time than it takes for them to completely cool, remove the ashes from the smoker, keeping them in heavy duty foil and soaking them completely with water before disposing of them in a non-combustible container.**
-  **DO NOT obstruct the flow of combustion air and/or ventilation air for the smoker.**

WARNING

-  Use caution when operating the door while in operation. Keep hands, face and body safe from hot steam or flare ups.
-  **DO NOT** wear loose clothing while operating the smoker. Tie back long hair while operating the smoker. **ALWAYS** wear fully-covering shoes while operating the smoker.
-  Allow the smoker and its components to cool completely before conducting any routine cleaning or maintenance.
-  **NEVER** use glassware, plastic or ceramic cookware on or in your smoker.
-  **NEVER** operate the smoker without water in the water pan. **NEVER** allow the water to completely evaporate. Check the water level at least every 2 hours. A sizzling sound may indicate a low water level or bellowing smoke may indicate no water in the water pan. Follow instructions in this manual for adding water while operating. Adding while operating may splash hot water and cause serious injury.
-  When using flavoring wood, add a sufficient amount prior to operation to avoid having to add wood while operating. Adding while operating may splash hot water and cause serious injury.
-  Use of accessories not intended for this smoker is not recommended and may lead to injury or property damage.
-  An LP cylinder not connected for use should not be stored in the vicinity of the smoker or any other appliances. **DO NOT** store spare LP cylinders within 10 feet of the smoker. LP cylinders must be stored outdoors and out of reach of children. **DO NOT** store LP cylinders in a building, garage or any other enclosed area.
-  While the smoker is not in use, the gas must be turned off at the supply cylinder.
-  LP gases are heavier than air, tend to pool and collect in low-lying areas, are easily ignited and are highly flammable. Proper care and caution should be employed when dealing with any such fuels.
-  The smoker should be shut off and all supply valves (on piping or fuel cylinders) should be closed in the event that the odor of unburned gas is detected. **DO NOT** attempt to use the smoker until any gas leaks are fixed and/or the source of the unburned gas odor is accounted for.
-  **DO NOT** use the smoker if the burner fails to light or fails to remain lit. Under such conditions, the gas should be cut off and the fuel cylinder should be disconnected.
-  Operating the smoker under **HIGH WIND** conditions could result in poor burner operation such as flame blow out and flaring, should be avoided. If repositioning the smokers does not improve operation under such wind conditions, the smoker should be shut off and gas supply at the LP cylinder closed.
-  All installations are to conform to local codes. In absence of local code, installation should conform to the National Fuel Gas code, ANSI Z223.1/NFPA 54.
-  The smoker should be installed with the hose regulator assembly extended at full length of the hose directly (24 inches (61cm)) away from the burner. When so configured, placement results in maximum LP cylinder-to-smoker distance. When the smoker is operated, the hose/valve/regulator (HVR) should be on a line perpendicular to wind direction. Placing the LP cylinder closer than 24 inches (61cm) to the smoker can overheat the LP cylinder and cause release of propane through relief openings and can result in cylinder fire or explosion.

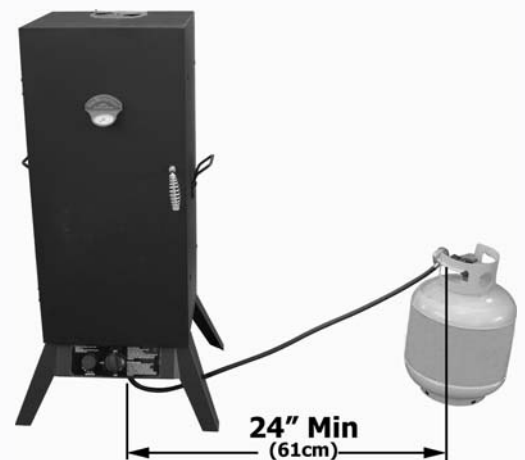

USE CAUTION AND COMMON SENSE WHEN OPERATING YOUR SMOKER. READ ALL INSTRUCTIONS, WARNINGS AND SAFEGUARDS BEFORE ASSEMBLING AND OPERATION YOUR SMOKER.

SAVE THESE INSTRUCTIONS!

Assembly Step 1 - Identifying the parts

Check your contents for these parts. If you are missing any parts or if any parts are damaged, please call our toll-free customer service line to order parts:

1-800-321-3473

DO NOT RETURN YOUR SMOKER TO THE RETAILER. PLEASE CALL US FIRST.

3425GW/3495GW Vertical Gas Smoker



AZ002130
Temperature
Gauge

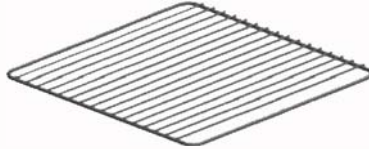

AZ002031 Cooking Rack



AZ002075
Adjustable
Chimney

AZ002100 Door Panel



AZ002098
CABINET & DOOR



AZ002009
Cool Grip
Wire Handle



AZ001109
Side
Handle



Z001166 Wood
Chip Box Lid



AZ001165 Wood
Chip Box



Z002125 Wood
Chip Box Stand



AZ002024
Water Pan

AZ002126
Control Panel
Assembly

AZ001105
Steel Tube Leg
with eyebolt insert



AZ002129 Damper
Vent with Plastic
Tip Guard



AZ002013
Burner Assembly

Assembly Step 1 - Continued

Check your contents for these parts. If you are missing any parts or if any parts are damaged, please call our toll-free customer service line to order parts:

1-800-321-3473

DO NOT RETURN YOUR SMOKER TO THE RETAILER. PLEASE CALL US FIRST.

3425GW/3495GW GAS VERTICAL SMOKER PARTS

Part Number	Description	Qty
AZ001105	STEEL TUBE LEG with eyebolt insert	2
AZ001106	STEEL TUBE LEG	2
AZ001109	SIDE HANDLE-Wrought Iron	2
AZ001165	STEEL WOOD CHIP BOX ONLY (8.4" X 8.4")	1
AZ001166	STEEL WOOD CHIP BOX LID ONLY (8.4" X 8.4")	1
AZ002009	COOL GRIP WIRE HANDLE	1
AZ002013	BURNER ASSEMBLY	1
AZ002015	HEAT CONTROL KNOB	1
AZ002017	HARDWARE KIT	1
AZ002024	WATER PAN	1
AZ002030	WIRE RACK TRACK	2
AZ002031	COOKING RACK	4
AZ002032	ROTARY IGNITOR	1
AZ002033	ROTARY IGNITOR KNOB	1
AZ002075	CHIMNEY ASSEMBLY	1
AZ002093	HOSE-VALVE-REGULATOR (part of Control Panel)	
AZ002098	CABINET ASSEMBLY	1
AZ002099	CABINET (no door)	1
AZ002100	DOOR PANEL	1
AZ002125	WOOD CHIP BOX STAND ONLY (for 8" x 8")	1
AZ002126	CONTROL PANEL ASSEMBLY - Rotary (13500BTU)	1
AZ002129	DAMPER PLATE with plastic tip guards	2
AZ002130	TEMPERATURE GAUGE with wingnuts	1
IM3425	INSTRUCTION MANUAL	1
31971	COVER (not included - available as a purchased accessory via our website: www.landmann-usa.com)	n/a

LP Tank and flavoring wood not included

Assembly Step 1 - Identifying the parts

Check your contents for these parts. If you are missing any parts or if any parts are damaged, please call our toll-free customer service line to order parts:

1-800-321-3473

DO NOT RETURN YOUR SMOKER TO THE RETAILER. PLEASE CALL US FIRST.

3425BGW/3495BGW Vertical Gas Smoker



AZ002130
Temperature
Gauge

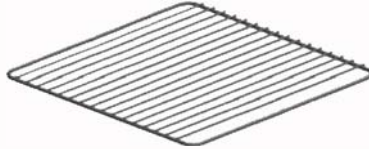

AZ002045 Cooking Rack



AZ002075
Adjustable
Chimney

AZ002102 Door Panel



AZ002101
CABINET & DOOR



AZ002009
Cool Grip
Wire Handle



AZ0001109
Side
Handle



Z001166 Wood
Chip Box Lid



AZ002129 Damper
Vent with Plastic
Tip Guard



AZ001165 Wood
Chip Box



AZ002024
Water Pan



AZ002125 Wood
Chip Box Stand

AZ002127
Control Panel
Assembly

AZ001105
Steel Tube Leg
with eyebolt insert

AZ001106
Steel Tube
Leg



AZ002038
Burner Assembly

Assembly Step 1 - Continued

Check your contents for these parts. If you are missing any parts or if any parts are damaged, please call our toll-free customer service line to order parts:

1-800-321-3473

DO NOT RETURN YOUR SMOKER TO THE RETAILER. PLEASE CALL US FIRST.

3425BGW/3495BGW GAS VERTICAL SMOKER PARTS

Part Number	Description	Qty
AZ001105	STEEL TUBE LEG with eyebolt insert	2
AZ001106	STEEL TUBE LEG	2
AZ001109	SIDE HANDLE-Wrought Iron	2
AZ001165	STEEL WOOD CHIP BOX ONLY (8.4" X 8.4")	1
AZ001166	STEEL WOOD CHIP BOX LID ONLY (8.4" X 8.4")	1
AZ002009	COOL GRIP WIRE HANDLE	1
AZ002015	HEAT CONTROL KNOB	1
AZ002017	HARDWARE KIT	1
AZ002024	WATER PAN	1
AZ002032	ROTARY IGNITOR	1
AZ002033	ROTARY IGNITOR KNOB	1
AZ002038	BURNER ASSEMBLY	1
AZ002044	WIRE RACK TRACK	2
AZ002045	COOKING RACK	4
AZ002075	CHIMNEY ASSEMBLY	1
AZ002095	HOSE-VALVE-REGULATOR (part of Control Panel)	
AZ002101	CABINET ASSEMBLY	1
AZ002102	CABINET (no door)	1
AZ002103	DOOR PANEL	1
AZ002125	WOOD CHIP BOX STAND ONLY (for 8" x 8")	1
AZ002127	CONTROL PANEL ASSEMBLY - Rotary (18000BTU)	1
AZ002129	DAMPER PLATE with plastic tip guards	2
AZ002130	TEMPERATURE GAUGE with wingnuts	1
IM3425	INSTRUCTION MANUAL	1
31973	COVER (not included - available as a purchased accessory via our website: www.landmann-usa.com)	n/a

LP Tank and flavoring wood not included

Assembly Step 2

Locate these parts:

Vent Damper Plate
with plastic tab guard



Tools needed:



Phillips Head
Screwdriver



1/2" Wrench

Hardware:



#10-24 nut
2 required



#10-24 lock washer
2 required



#10-24 x 5/8" bolt
2 required

Hardware Bag **E**

1. Remove all loose inner packages from inside cabinet. Set the cabinet assembly top side down. To prevent scratching or damage to your smoker, set the cabinet on a padded surface like cardboard or carpet.
2. Set the damper plate on the side of the cabinet and align it with the corresponding "butterfly" holes. The metal tab should seat inside the one of these holes and the plastic tab guard should be positioned towards the top of the smoker.
3. Insert a bolt through the damper plate center hole and through corresponding hole in the center of the "butterfly" hole.
4. From the inside of the cooking chamber, place a lock washer and nut on the bolt and secure.
5. Thread nut just tight enough to keep the damper plate snug but all it to rotate with little resistance.
6. Repeat on other side of cooking chamber.

Note that the metal tab that goes inside the "butterfly" holes is specifically designed to keep these vent partially open at all times.

This is a safety feature required in all Smoky Mountain Vertical Smokers.

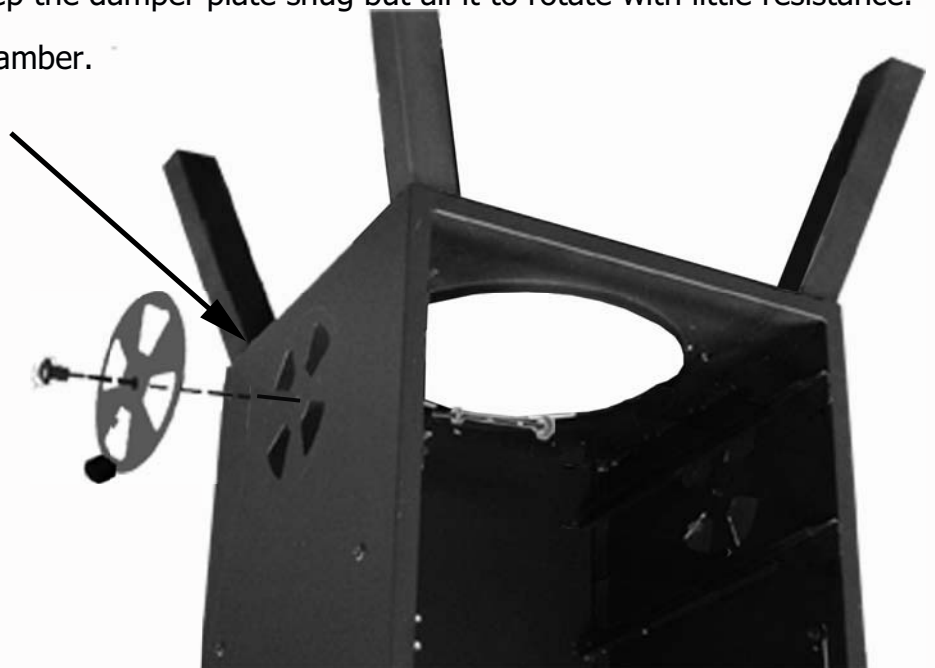

Assembly Step 3

Locate these parts:

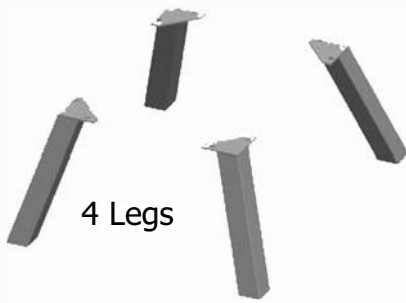

Cabinet Assembly



Tools needed:



Phillips Head
Screwdriver

Hardware:



Hardware Bag **A**

1/4-20 x 5/8" bolts
8 required

1. For each leg, line up the holes and insert the bolts. Nuts are pre-welded to the cabinet. The back legs bolts should be inserted and securely tightened. For the front leg bolts, insert and adjust 1 bolts per leg (as shown) 1/2 way.

IMPORTANT: There are two legs that contains an extra hole must be mounted in the front position as shown. This hole will be used to secure the control panel to the legs with bolts.

2. DO NOT yet insert the two (2) bolts in the locations indicated. These two bolts will be used in the next assembly step.

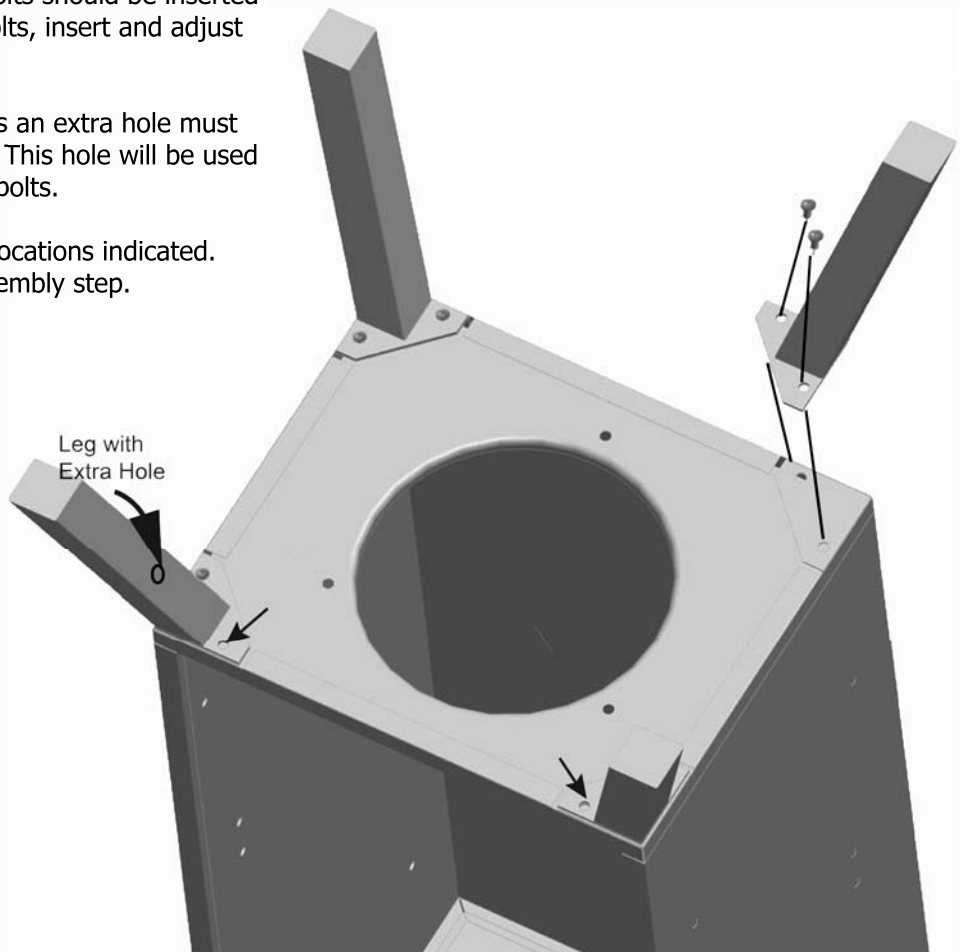

Assembly Step 4

Locate these parts:



Control Panel Assembly

Tools needed:



Phillips Head
Screwdriver

Hardware:



1/4-20 x 5/8" bolts
2 remaining bolts from Step 2



10#-24 x 1/2" bolts
2 required

Hardware Bag **(B)**

1. Place the control panel assembly between the front legs as shown. Insert the two (2) remaining bolts 1/2 way. DO NOT tighten them until the next step has been finished.
2. Align the side holes on both sides of the control panel to match the holes on the legs. Insert the two (2) 10#-24 x 1/2" bolts and tighten them securely.
3. Make sure to securely tighten bolts in #1.

Legs should be positioned as shown

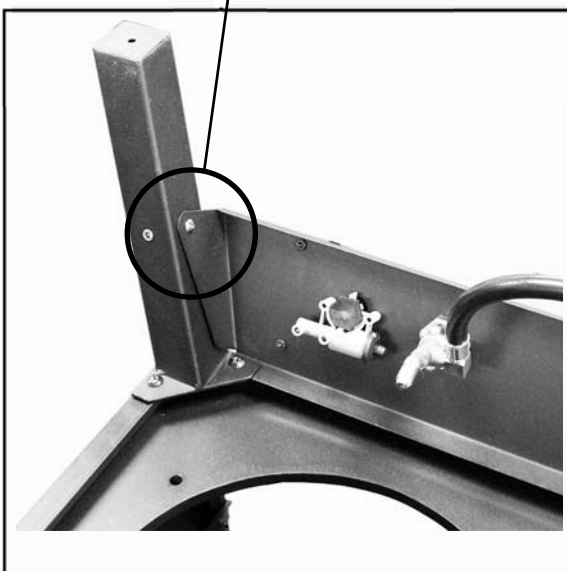

Assembly Step 5

Locate these parts:

Burner Assembly



Tools needed:



Phillips Head
Screwdriver

Hardware:

Hardware Bag 



1/4-20 x 1/2" bolts
3 required

1. Set the burner assembly onto the cabinet as shown.

IMPORTANT: The burner tube must slide properly onto the brass valve stem as shown below. An improper fit will result in poor gas flow and operation of the smoker.

2. Secure the burner assembly with the three (3) bolts from the inside of the cabinet that will attach directly to the burner assembly. Securely tighten the bolts.

3. Attach the loose igniter wire to the igniter on the control panel as shown.



Proper fit between
burner and brass
valve stem

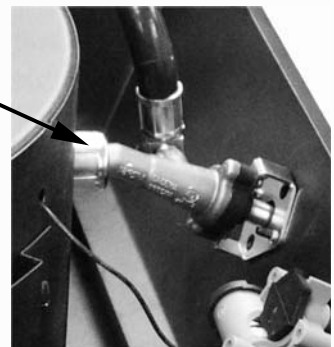

Proper igniter wire connection

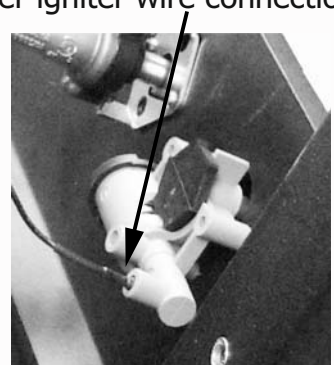

Assembly Step 6

Locate these parts:



Adjustable Chimney

Tools needed:



Phillips Head
Screwdriver

Hardware:



1/4-20 x 5/8" bolts
3 required

Hardware Bag **D**

1. Turn the smoker upright. Ideally, it needs 2 people to lift the smoker up. Carefully tilt the cabinet on the side legs, grasp the empty hole for the adjustable chimney and pull up gently until smoker is upright on all four legs.
2. Set the Adjustable Chimney on top of the cabinet and align the 3 thread tabs from the underneath with the corresponding holes. The nuts for the bolts are pre-welded to the bottom of the chimney base. Position Adjustable Chimney knob so the adjustment now is on the right side.
3. Reaching inside the cooking chamber, thread a bolt through the corresponding opening and into the pre-welded nuts. Thread each bolt 1/2 way until all 3 bolts are threaded and then tighten each bolt securely.

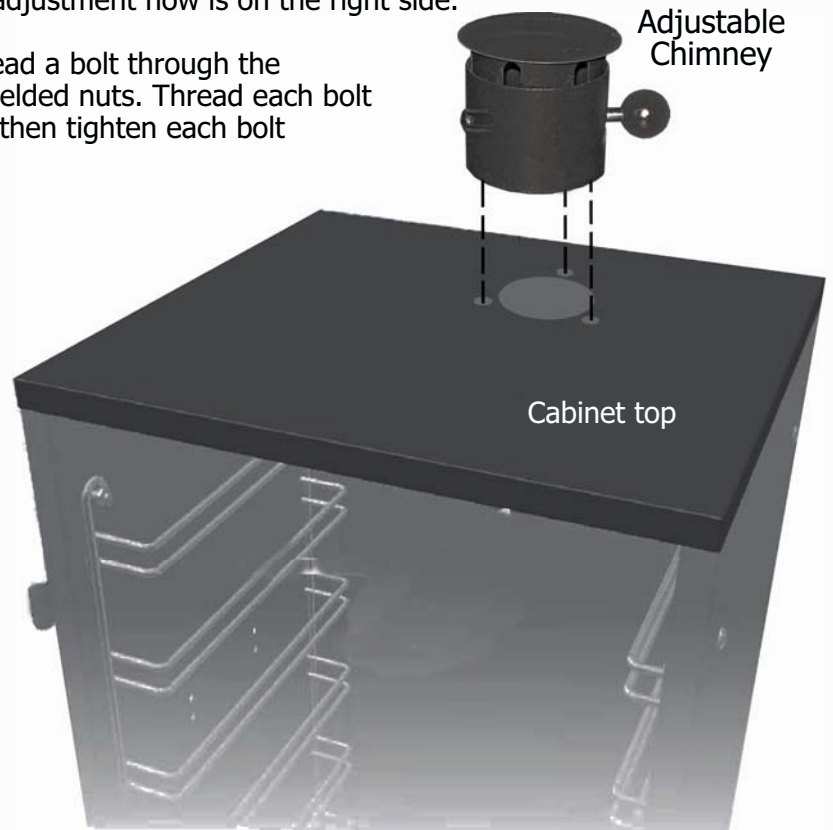

Assembly Step 7

Locate these parts:



2 Side Carry handles

Tools needed:



Phillips Head
Screwdriver



1/2" Wrench

Hardware:



1/4-20 Nuts
8 required



1/4-20 Lock Washers
8 required



1/4-20 x 5/8" Bolt
8 required

Hardware Bag (F)

1. Align the side carry handle with the corresponding holes on the side of the cabinet. Then handles must be positioned upright with the bolt holes on the bottom.
2. Insert the bolts from the outside and the thread the lock washers and nuts from the inside of the cabinet.
3. Securely tighten the nuts using both screwdriver and wrench.
4. Complete steps for both sides of the cabinet assembly.

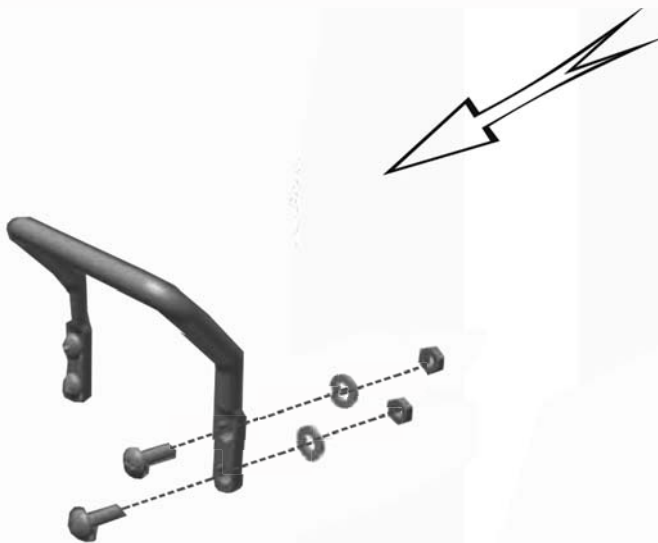

Assembly Step 8

Locate these parts:



Wood Chip Box

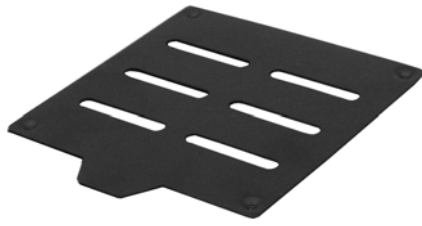

Wood Chip Box Lid

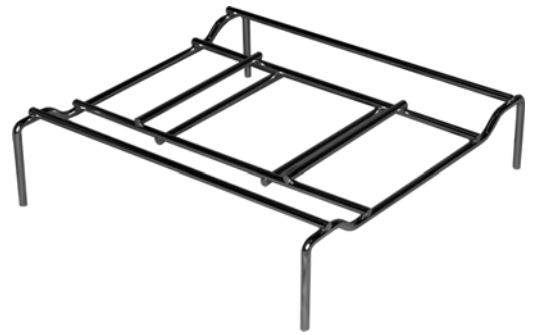

Wood Chip Box Stand

No tools or hardware are required for this step.

1. Insert the wood box rack into the bottom of the smoker. The feet of the rack sit in the four indentions in the bottom.
2. Set the wood chip box onto the rack. Make sure it is seated properly and securely in the center of the rack.
3. Place the lid on the wood chip box.



Assembly Step 9

Locate these parts:

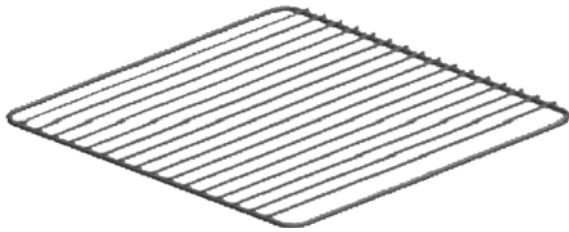

Cooking rack



Water Pan

No tools or hardware are required for this step.

1. Slide water pan into the rack directly above the wood chip box.
2. Insert the cooking racks into remaining positions and use as desired.
For best access, the cooking rack grid wires should run from front to back as shown.



Assembly Step 10

Locate these parts:

Door Handle Kit

Hardware Bag 

Tools needed:

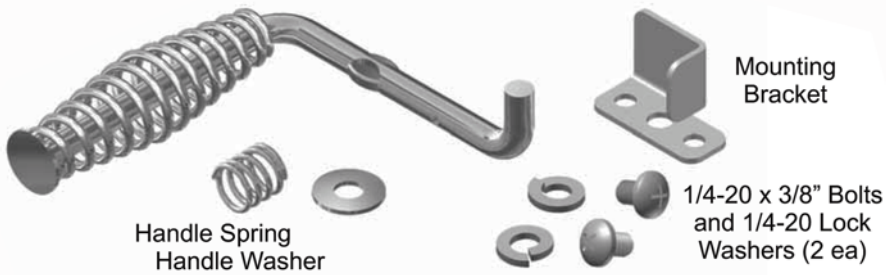

1. Slide the handle washer onto the end of the door handle, followed by the handle spring as shown.
2. Feed the door handle into the hole through the front of the door panel.
3. From the back side of the door panel, insert the mounting bracket over the end of the handle as shown.
4. With lock washers placed on the bolts, insert the bolts through the mounting plate, into the pre-threaded mounts and firmly tighten the bolts.

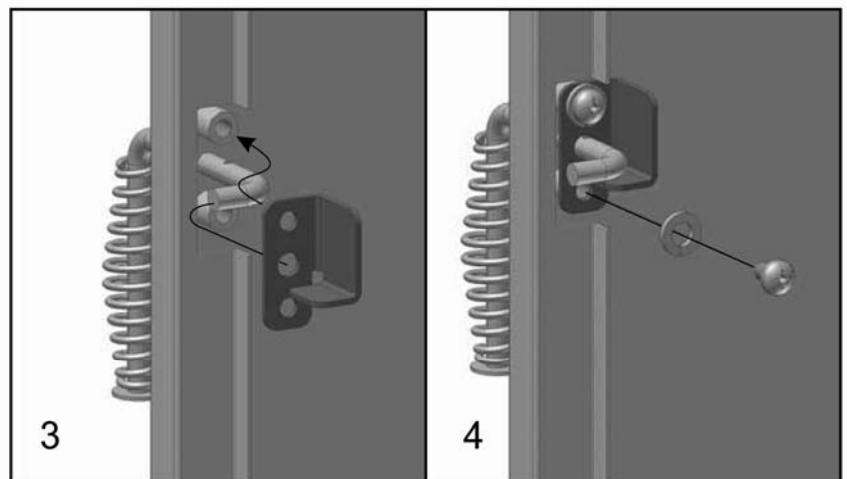

Assembly Step 11

Locate these parts:

Name-plate
Temperature Gauge

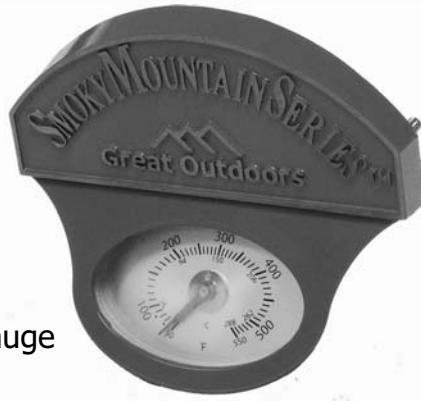

2 wingnuts



2 flat washers

Hardware Box **I**

NOTE: No tools or hardware are required for this step.

1. Insert the Temperature Gauge mounting pins through the mounting holes in the front of the door panel.
2. From the inside of the door, securely attach flat washer and wingnut to each mounting pin.

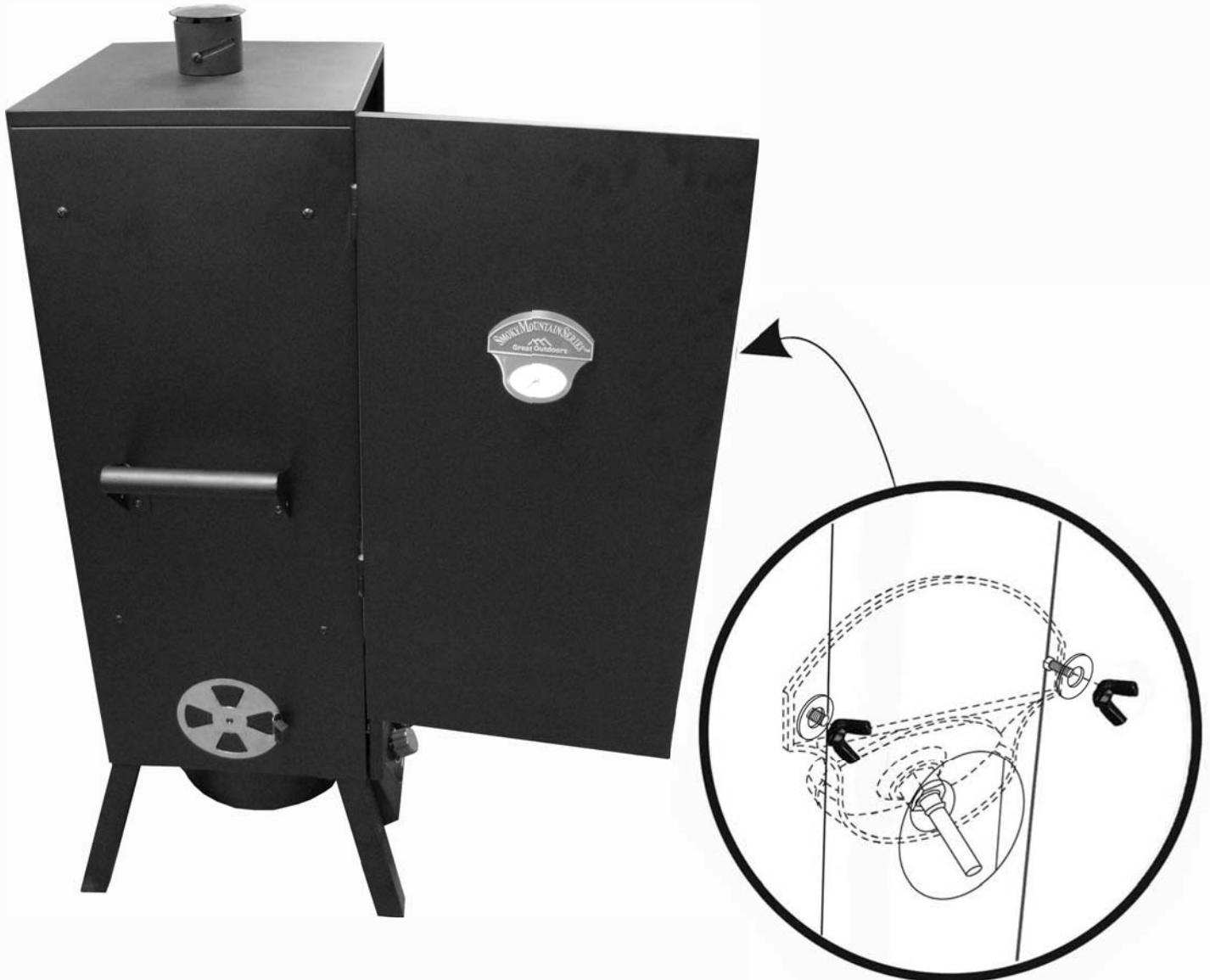

Assembly Step 12

Locate these parts:

Hardware Bag **J**



R-Hook



Zip Tie



S-Hook

Tools needed:



Pliers



Insert the R-Hook into the pre-threaded mount on the front legs as shown. And firmly tighten it.



Using the zip tie, secure the hose to the front leg as shown. Do not pull the zip tie tight - leave it just loose enough so the hose can be adjusted if needed.

Tying the hose to the leg helps prevent the hose from coming into contact with the hot burner chamber. Inspect the installation underneath the smoker to ensure the hose is not rubbing any position of the burner chamber.

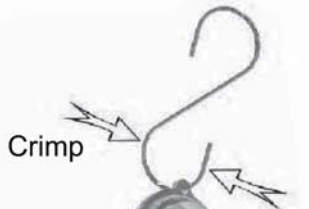

Crimp

1. Place one end of the S-hook around the regulator neck or through the eyelet as shown.
2. Using a set of pliers, crimp the S-hook securely to the HVR so it can not be removed from the HVR.
3. When the LP tank is not attached to the smoker, use the S-hook to hand the HVR on the side handle of the smoker. This will help prevent dirt and other particles from plugging the end of the HVR.

OR



Assembly is now complete! Please follow all instructions and safeguards on the following pages for connecting the LP tank.

CONNECTING THE LP CYLINDER

WARNING

ALL INSTRUCTIONS AND SAFEGUARDS ON THIS PAGE MUST BE FOLLOWED TO PREVENT FIRE, DAMAGE AND/OR INJURY.

IMPORTANT: Any fuel supply cylinder used must be constructed and marked in accordance with specifications for propane cylinders of the U.S. Department of Transportation (DOT) CFR 49, or CAN/CSA B339. The appliance used only with the 20 pound, vertical standing vapor withdrawal type tank.

This smoker is designed to operate on LP (Liquified Propane) gas only. This smoker is not to be utilized with non-self-contained LP gas supply system.

The 20 lb LP Cylinder used with this smoker must conform to the following requirements:

Diameter - 12" (30.5cm)

Height - 18" (45.7cm)



With a maximum capacity of 20 pounds.

The LP cylinder used must include a color to protect the cylinder valve. The cylinder system must be arranged for vapor withdrawal.

 **The instructions stated on the LP cylinders have to be followed when filling and transporting cylinders. Failure to do so could result in problems relating to overfilling, excessive venting of gas and to regulator freezing.**

Do not allow dirt or foreign material to get into or onto the cylinder connection when it is not attached to the fuel supply system. Place the dust cap on the cylinder valve outlet whenever the cylinder is not in use. Only install the type of dust cap on the cylinder valve outlet that is provided with the cylinder valve. Other types of caps or plugs may result in leakage of propane.

DANGER

-  **(A) DO NOT store tanks under or near the smoker.**
-  **(B) NEVER fill cylinders more than 80% full.**
-  **If instructions A and B above are not followed exactly, a fire causing death or serious injury may occur.**



Cylinders must be filled before initial use. All handling, transport, filling and storage of LP gas cylinders must be in accordance with NFPA 58 Storage and Handling of Liquid Petroleum Gases, or CSAB 149.1 Natural Gas and Propane Installation code. Cylinders must be suitably tied down during transport. DO NOT place any other items on top of the cylinders at any time. Cylinders are not to be exposed to excessive temperatures or high heat.

If there is a question on the identity of your smoker and of the type of fuel to be used, please look on the data plate. Smokers are factory equipped for use on only one type of fuel. These smokers cannot be, and should not be used on other types of fuel. Doing so can cause severe damage to the smoker and the installation area and the added risk of serious injury.

Any attempt to operate these smokers on fuels for which they are not design certified VOIDS THE MANUFACTURER'S WARRANTY.

Gas Cylinder outlet must have Type 1 gas connection termination in order to mate with gas hose provided with smoker.

The pressure regulator and hose assembly supplied by the manufacturer with the smoker must be used. Replacement pressure regulators and hose assemblies must be those specified by the smoker manufacturer.

The regulator/hose assembly should be handled carefully to prevent contamination by foreign objects and dirt. The assembly should be inspected before use and any dirt or contamination should be wiped off. In order to insure proper installation, any replacement of the fuel cylinder regulator assembly has to be done with parts authorized by the smoker manufacturer.

CONNECTING THE LP CYLINDER - Continued

WARNING

ALL INSTRUCTIONS AND SAFEGUARDS ON THIS PAGE MUST BE FOLLOWED TO PREVENT FIRE, DAMAGE AND/OR INJURY.

 **Valve/pressure regulators are factory set to the correct operating pressures. NO attempts should be made to adjust these settings.**

Connecting the LP Gas Cylinder:

1. The valve on the LP cylinder must be closed. See that the knob is turned clockwise to a full stop.
2. Check that the control knob on the smoker is turned OFF.
3. Remove the protective cap from the LP Cylinder valve and coupling nut, if present.
4. Hold the regulator in one hand and insert the nipple into the valve outlet. Be sure the nipple is centered in the valve outlet. The coupling nut connects to the large outside threads on the valve outlet, Use care - DO NOT cross thread the connection.
5. Hand tighten the coupling nut clockwise until it comes to a full stop. Firmly tighten by hand only. DO NOT USE TOOLS.

CAUTION: In the connection process, the regulator side of the connection will seal on the back check in the valve, resulting in a slight resistance. The connection requires about one-half (1/2) to three-quarters (3/4) additional turn to complete the connection.

When setting up the smoker and cylinder, it is recommended to have the cylinder and the smoker on a line perpendicular to the wind direction.

The gas hose/regulator assembly should be totally extended to the maximum distance so that the hose is straight and the cylinder is as far from the smoker as it can be.

LP cylinders are intended for operation in the upright position only.

Care should be taken to protect the fuel supply hose from damage for either foot or vehicle traffic.

If the smoker is not in use, the gas must be turned off at the LP cylinder and the cylinder should be disconnected from the smoker and stored away from the smoker.

Storage for the smoker indoors is only permissible if the LP cylinder is disconnected and removed from the smoker.

LP cylinder must be stored outdoors out of reach of children and pets, and must not be stored in a building, garage or any other enclosed area.

Leak Testing (Check for gas leaks)

After all connections are completed, check all connections and fittings for leaks with a soap solution.

- * Mix dish soap with water (about 3:1 mix ratio)
- * With all valves closed, apply the soap solution to all gas flow connections and fittings.
- * Open LP Cylinder valve about 1 -1/2 turn.

Presence of bubbles at areas of wet solution indicates a gas leak.

If leaks are detected or you smell or hear gas, shut off the valve and repair the leak or replace the defective part. DO NOT USE THE SMOKER UNTIL ALL LEAKS ARE CORRECTED.

DANGER

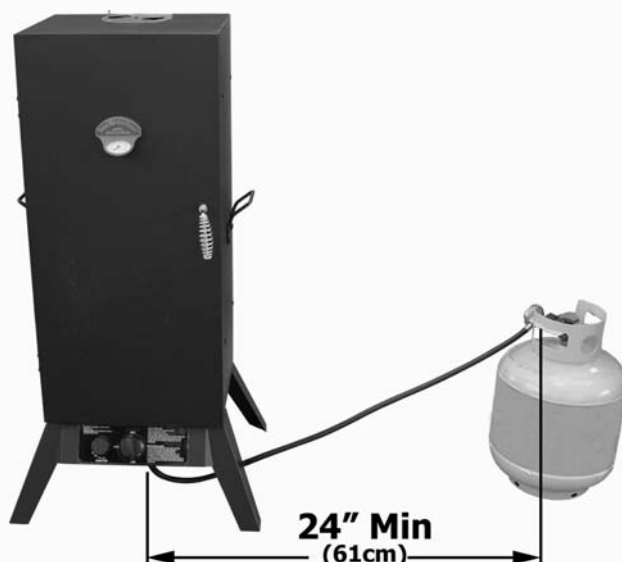

OPERATING INSTRUCTIONS

PRE-USE PROCEDURES:

Before you cook food in our smoker, it is important to "season" your smoker. Seasoning seals the paint and interior of your smoker to enhance flavoring, durability and overall performance. This is also referred to as the "break-in" process.

If your smoker requires any touch-up paint on the inside of the cabinet, the only time you should apply paint to the inside is before the seasoning process. Paint should be applied to the interior of your smoker after your smoker has been used. See these section in this instruction manual concerning AFTER USE CARE AND MAINTENANCE.

To season your smoker, simply use it as you normally would, only DO NOT cook any food. You will need to follow all of the operating procedures in the next few sections of this manual.

Using our desired flavoring woods and marinades, and placing water in the water pan, burn your smoker at the lowest temperature by setting your control knob to LOW, and allow 45-60 minutes for this burn. Turn the Smoker to the OFF position and disconnect the LP Cylinder. Allow the smoker to completely cool and then clean out the used water and wood.

Once the seasoning is complete, your smoker's interior will have a durable, seasoning coating.

ADDING WATER:

To add water before cooking:

For one door smokers, simply remove water pan and fill it with water up to 1" (25mm) below the rim. Then carefully place the water pan in the correct shelf position in the cabinet. To add water while the smoker is hot, DO NOT PULL THE WATER PAN OUT! To safely add water to the water pan, use a clean watering can with a long spout (or similar device).



For Two Drawer smokers, open water pan drawer and fill with water up to 1" (25mm) below the rim. Slowly and steadily, push water pan drawer closed until it comes to a complete stop. To add water while the smoker is hot, SLOWLY open the water pan drawer to prevent any splashing of remaining water. Replenish the water as need and then again SLOWLY and CAREFULLY push the water pan drawer closed until it comes to a complete stop.



ADDING WOOD CHIPS

To add wood chips before smoking, fill the wood chip box with your choice of flavoring hardwood chips. The amount and type of wood you use is entirely up to you. One full filling of the wood chip box is typically enough for several hours of smoking. Once the wood chip box is filled, place the lid on top of the wood chip box and set the box into the correct location of the smoker. For one door smokers, the wood chip box should be either placed on the wood chip box stand or frame, whichever is applicable. For two drawer smokers, the wood chip box should be placed in the lower drawer that has a frame specifically designed for the wood chip box.



COOKING TIPS - Flavored woods:

- * Small wood chips work best inside the wood chip box.
- * Use dry hardwoods such as hickory, pecan, apple, cherry or mesquite.
- * Most fruit and nut tree woods produce an excellent smoke flavoring.
- * Do not use resinous woods such as pine. These usually product unpleasant flavoring.
- * Let our tast be your guide - experiment with different types and quantities of wood chunks, chips or sticks. You also mix woods.
- * To produce more smoke and prevent fast burning, pre-soak the wood chips in a separate bowl of water for at least 30 minutes, or wrap the chips in perforated aluminum foil. [See wood chip manufacturer's instructions]
- * Most smoker flavoring occurs within the first hour of cooking. Adding wood chips after the first hour is typcially not necessary unless extra smoke flavoring is desired.



CAUTION

THE WOOD CHIP BOX AND LID WILL GET VERY HOT DURING SMOKING. AVOID HANDLING THEM WHILE IN USE. ALWAYS WEAR PROTECTIVE OVEN MITTS WHEN HANDLING HOT COMPONENTS.

CHIMNEY AND DAMPER VENT ADJUSTMENTS

Temperature maintenance is best controlled by different chimney and side damper adjustments. The key to effective smoking is to watch your heat indicator (temperature gauge) on the door and adjust the chimney and side dampers accordingly.

- * For better performance, rotate the smoker to where the front or boack of the smoker is facing the wind. This allows the adjustment of the chimney and side damper vents to be more effective and accurate.
- * Opening the chimney and side damper vents helps to exhaust both heat and smoke.
- * The chimney and side dampers vents **SHOULD NEVER BE FULLY CLOSED.**
- * Opening the side damper vents allows more oxygen to be consumed by the fire, fueling flames and causing an increase in temperature.
- * Temperature maintenance is best controlled by different chimney and side damper adjustment configurations.

LIGHTING PROCEDURES:

Igniter Lighting System:

1. Check all connections for leaks using the "soapy water" test as explained on page 21.
2. Open the smoker cabinet door.
3. Check for any blockage to the venturi tube or burner. Remove any foreign objects or matter.
4. Be sure the burner control knob is in the "OFF" position.
5. Open the LP Cylinder valve 1-1/2 turn by turning counter-clockwise.
6. To light unit with the igniter, turn the burner control knob to the High (Lighting Position) and then immediately, rotate the igniter knob clockwise until it clicks (you should see a small spark jumping from the end of the electrode rod to the side of the burner). This spark should ignite the gas coming through to the burner. Adjust your flame down with the burn control knob to your desired setting.

If the burner doesn't light within 3 to 5 seconds, turn the burner control knob to "OFF", and wait five (5) minutes.

CAUTION: Some LP gas, being heavier than air, may have settled near the burner during the initial lighting attempt. Prior to attempting to relight the burner, fan out the bottom of the cabinet of existing air. Then repeating the above lighting steps again.

If burner still fails to light, try match lighting the smoker using the instructions noted below.

Once the burner is lit, then gently close the door to allow heat to accumulate. The damper vents and chimney can then be adjusted to the desired setting to allow proper air flow and combustion. Damper vent adjustment tips are listed on the next page.

Match Lighting:

1. Repeats steps 1 through 5 of the Igniter Lighting System above.
2. Remove the water pan and wood chip box (including stand or frame) from the inside of the smoker. Light a match and drop it into the burner chamber, making sure it falls next to the brass burner. Quickly turn the control knob to the High (Lighting Position). If the burner does not light within 4 or 5 seconds, turn the burner control knob to OFF, wait five (5) minutes, fan out the bottom of the cabinet of existing air, then and repeat the process.

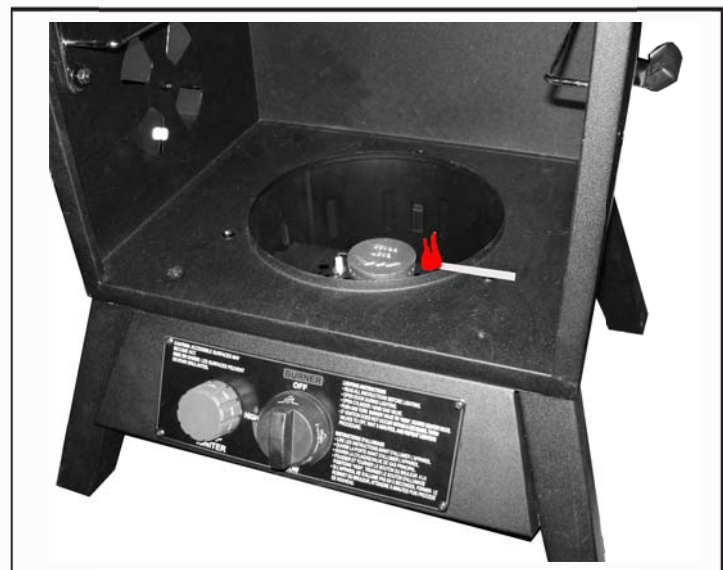
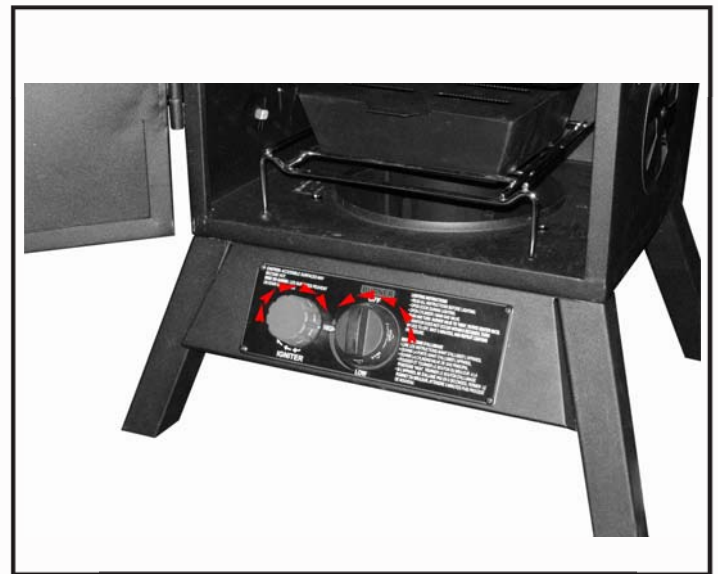

COOKING INSTRUCTIONS:

IMPORTANT: Before each use, clean and inspect the hose and the connection to the LP cylinder. If there is evidence of abrasion, wear, cuts or leaks, the hose must be replaced before the smoker is used. Refer to the "Leak test instructions" in the LP Cylinder portion on this instruction manual.

- * Fill the wood chip box with flavoring wood chips and place the box with lid on, inside the smoker as instructed in the assembly section of this instruction manual. Refer to the section that explains flavoring wood for recommended use of flavoring wood.
- * Place the water pan inside the smoker as instructed in the assembly section of this instruction manual. Carefully fill the water pan with water (or marinade) up to 1" (25mm) below the water pan rim. DO NOT over fill or allow water to overflow from the water pan. A full water pan should last for approximately 2-3 hours. Checking and adding water to the water pan is covered on page 21.
- * Insert or adjust the cooking racks to the desired rack positions. For better access to the food with tongs or spatulas, (1) use only the cooking racks needed for your smoking and (2) be sure the grids of the cooking racks run front-to-back as shown in the assembly section.
- * You are now ready to light the burner! Refer to the Lighting procedure on the previous pages of this manual and carefully follow the directions. The heat from the burner will allow the wood chips to burn, causing the flavoring smoke to accumulate. Adjust the Chimney and side dampers to control the heat.
- * Place the food on the cooking racks in a single layer with space between each piece. This will allow smoke and hot moisture to circulate evenly around the food pieces.
- * Depending on meat and size, smoking for 2 to 3 hours at the ideal constant cooking temperature of 225°F to 250°F will get the best results. The temperature is according to the heat indication (temperature gauge) mounted on the front of the door. For more tender and heavily smoked meat, a lower temperature of 220-225°F and smoking for 4 to 6 hours, may be preferred. If time is critical, a higher temperature range is recommended.
- * Always use a meat probe thermometer to ensure the food is fully cooked before removing it from the smoker.
- * Check the water periodically and add water if low. For best results and to retain heat, avoid opening the door or drawer of the smoker while in use. When the door or drawer must be opened, only open it briefly. The smoker will quickly resume cooking temperature after the door or drawer are closed.
- * After each use, and after the smoker has cooled, carefully remove the water pan from the smoker, empty the water and clean the water pan. Same procedure for the wood chip box.

SHUTTING OFF SMOKER:

CAUTION: The smoker can be very hot while in use. DO NOT touch any portion of the smoker except for the door or drawer handles, and burner control knob. It may be necessary to use protective gloves.

- * Turn the burner control knob to OFF by pushing in and rotating clockwise. The burner flame should go out. Turn off the LP Cylinder valve by turn the knob clockwise until it stops.
- * Follow all warnings and safety precautions before removing meat from smoker or preparing the smoker for storage. See instructions on proper storage procedures. See all warnings and safeguards on Pages 3 and 4.

TEMPERATURE CHART

Here is a chart for measuring properly cooked meat temperature:

(USDA Standard)

CAUTION

The below temperatures are measured with a meat probe thermometer. The heat indicator on the door of the smoker **SHOULD NOT** be used as an accurate meat temperature reading.

Ground Meats & Meat Mixtures:

Turkey	165°F (74°C)
Veal, Lamb	160°F (71°C)
Beef, Pork	160°F (71°C)

Fresh Beef:

Medium Rare	145°F (63°C)
Medium	160°F (71°C)
Well Done	170°F (77°C)

Fresh Lamb:

Medium Rare	145°F (63°C)
Medium	160°F (71°C)
Well Done	170°F (77°C)

Fresh Beef:

Medium Rare	145°F (63°C)
Medium	160°F (71°C)
Well Done	170°F (77°C)

Fresh Pork:

Medium	160°F (71°C)
Well Done	170°F (77°C)

Ham:

Fresh (raw)	160°F (71°C)
Pre-cooked	140°F (60°C)

Poultry:









Chicken (whole)	180°F (82°C)
Turkey (whole)	180°F (82°C)
Breasts, roast	170°F (77°C)
Thighs, wings	180°F (82°C)
Duck and Goose	180°F (82°C)

Fish:

Cook until opaque and flakes easily

AFTER USE SAFETY

WARNING

-  Use caution when lifting or moving the smoker to avoid strains or back injury. Two (2) people are recommended to lift or move the smoker.
-  DO NOT place cover on smoker if the smoker is still hot.
-  DO NOT store the smoker near gasoline or other combustible liquids or where combustible vapors may be present. Keep the area around the smoker clear of combustible material or vapors.
-  DO NOT store this smoker in an area accessible to children or pets. Store the smoker in a dry, protected location.
-  DO NOT allow anyone to conduct activities around the smoker during use until it has completely cooled. It is hot during operation and remains hot for a period of time following use.
-  DO NOT leave hot ashes unattended until the smokers cools completely.
-  This smoker becomes extremely hot - allow the smoker to cool completely before handling. If you must handle the smoker while it is hot, ALWAYS wear protective oven mitts or heat resistant gloves when handling the smoker or its components. Allow the smoker to cool completely before removing the water pan, wood chip box, cooking racks and/or grease pan for cleaning.
-  Dispose of cold ashes by wrapping them in heavy duty aluminum foil and putting them in a non-combustible container. Be sure there are no other combustible materials in or near the container.
-  If you must dispose of the ashes in less than time than it takes for them to completely cool, remove the ashes from the smoker, keeping them in heavy duty foil, and soak them completely with water before disposing of them in a non-combustible container.

USE CAUTION AND COMMON SENSE WHEN OPERATING YOUR SMOKER. READ ALL INSTRUCTIONS, WARNINGS AND SAFEGUARDS BEFORE ASSEMBLING AND OPERATION YOUR SMOKER.

SAVE THESE INSTRUCTIONS!

AFTER USE CARE AND MAINTENANCE

CAUTION: All care and maintenance procedures are to be performed only while the smoker is turned off and completely cooled.

To clean, remove the water pan, wood chip box and cooking racks from the smoker. Clean with hot, soapy water and rinse and dry thoroughly. You may prefer to coat the water pan cooking racks lightly with cooking oil or cooking spray.

Frequently check and clean the venturi tube and burner for insects and insect nests. A clogged tube can lead to fire outside the smoker. Also make sure the smoker does not have any foreign objects obstructing the flow of combustion and ventilation air.

If your heat indicator seems to be out of calibration. Remove the heat indicator from the door of the smoker by loosening the push nut or wing nut from the inside. There is a second nut mounted on the back of the heat indicator that can be turned to adjust the heat indicator needle. Set the needle to the current outdoor ambient temperature and remount the heat indicator to the door of the smoker.

To clean the inside and outside of the smoker cabinet, simply use a damp cloth. Spray washing with a water hose is not recommended. All moisture should be wiped away and not allowed to stand inside or on top of the smoker. Carefully remove the grease pan, dispose of the grease and wash thoroughly. Once cleaned, you may prefer to lightly coat the interior of the smoker cabinet with cooking oil or cooking spray.

If rust is present on the exterior of the smoker, clean it thoroughly with steel wool or emery cloth and use heavy duty, heat resistant paint to cover affected area.

NEVER APPLY additional paint to the interior of the smoker. If rust is present on the interior of the smoker, clean thoroughly with steel wool or emery cloth, and lightly coat the area with cooking oil or cooking spray to minimize recurring rust.

When an LP tank is not connected, and to prevent dirt or other foreign particles from clogging the HVR, hand the end of the HVR hose from the side handle using the supplied S hook.

Inspect the flames at the burner by looking through the front access hole. A good flame should be blue with a yellow tip and be 1"-2" in length. If flames are excessively yellow and irregular, oil residue and/or food deposits may be collecting on the burner. Try cleaning the burner surfaces and the burner holes to improve the flames. Bad flames may be also caused by poor HVR-to-venturi attachment.

ALWAYS allow the smoker to cool completely before cleaning or checking the assembly.

To protect your smoker from weather, ALWAYS keep your smoker covered when not in use. Cover for your smoker is available for purchase by calling our Customer Service department or visiting our website at www.landman-usa.com

To obtain replacement parts or accessories, call our toll free Customer Service line at **1-800-321-3473**.

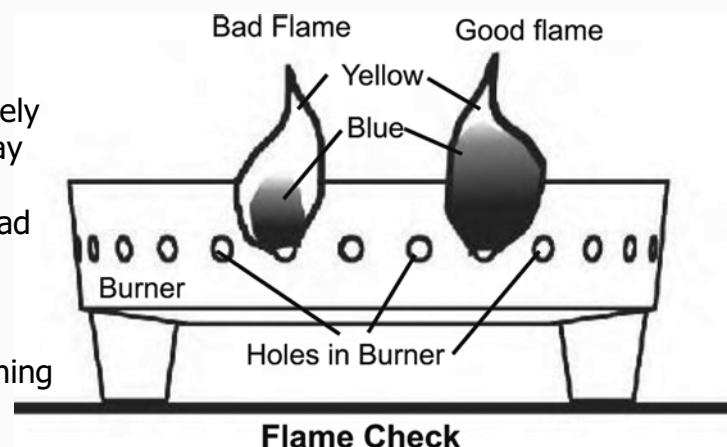



Manufacturer's Limited Warranty



The Great Outdoors® Smoky Mountain Series™ smoker is guaranteed against broken or damaged parts at the time of purchase. The cast brass burner is guaranteed for 10 years. All other parts carry a 1-year limited warranty except the water bowl, which is guaranteed to be free of defects for 90 days. Paint is guaranteed to be free of defects for 90 days except for rust, which may appear after repeated use.

This warranty does not cover damage or issues related to neglect, abuse, or modifications to the product. Repair labor is not covered.

All parts that meet the warranty requirements will be shipped at no-charge via the discretion of the Customer Service Department (ground shipments, US Mail, or Parcel Post ONLY). Any special handling charges (i.e. Second Day, Overnight, etc.) will be the responsibility of the consumer.

All warranty claims apply only to the original purchaser and require a proof of purchase verifying purchase date. Do not return parts to our address without first obtaining a return authorization number from our customer service. This service is available by calling toll free

1-800-321-3473- Monday to Friday 9:00am to 5:00pm Eastern Standard Time

This warranty may give you specific legal rights that vary by state.



LANDMANN

Landmann USA, Inc.
101 Old Mill Road, Building 300
Cartersville, GA 30120