

This Owner's Manual is provided and hosted by Appliance Factory Parts.



FISHER & PAYKEL DD24DCHTX6 Owner's Manual

[Shop genuine replacement parts for FISHER & PAYKEL
DD24DCHTX6](#)



[Find Your FISHER & PAYKEL Dishwasher Parts - Select From 34 Models](#)

----- Manual continues below -----



Fisher & Paykel

DishDrawer®
DD24 and DD60 models

User guide

US CA NZ AU GB IE

Safety and warnings	2
Electrical connection (GB IE only)	5
Operating instructions	
Controls (models with no LCD)	6
Controls (models with LCD)	8
Quick start	10
Caring for your dinnerware	11
Racking and accessories	12
Loading suggestions	16
Water hardness and dishwashing	18
Wash programmes and detergent quantities	19
Detergent dispenser	20
Using tablets	21
Rinse aid dispenser	22
Water softener	23
Option adjustments	26
User maintenance instructions	29
Troubleshooting	32
Fault codes	34
Warranty and service	37
Wash programme data	38
Standards test - <i>USA and Canada</i>	40
Standards test - <i>New Zealand and Australia</i>	41
Standards test - <i>Great Britain and Ireland</i>	42

Important!

SAVE THESE INSTRUCTIONS

The models shown in this user guide may not be available in all markets and are subject to change at any time. For current details about model and specification availability in your country, please visit our local website listed on the back cover or contact your local Fisher & Paykel dealer.

2 Safety and warnings

Your DishDrawer® has been carefully designed to operate safely during normal dishwashing procedures. Please keep the following instructions in mind when you are using your DishDrawer®.

Important safety instructions

WARNING! - When using your dishwasher, follow basic precautions, including the following:

- Read all instructions before using the DishDrawer®.
- The information in this manual must be followed to minimise the risk of fire or explosion or to prevent property damage, personal injury or loss of life.
- Use the DishDrawer® only for its intended function as described in this user guide.
- This appliance is intended to be used in household and similar applications such as:
 - staff kitchen areas in shops, offices and other working environments;
 - farm houses;
 - by clients in hotels, motels and other residential type environments;
 - bed and breakfast type environments.
- Use only detergents or rinse aid recommended for use in a domestic dishwasher and keep them out of reach of children. Check that the detergent dispenser is empty after the completion of each wash programme.
- When loading items to be washed, locate sharp items so that they are not likely to damage the lid seal and load sharp knives with the handle up to reduce the risk of cut-type injuries.
- Do not touch the heater plate during or immediately after use.
- Do not operate your DishDrawer® unless all enclosure panels are properly in place.
- Do not tamper with the controls.
- Do not abuse, sit on, stand in or on the drawer or dish rack of the DishDrawer®.
- The DishDrawer should not be left in the open position since this could present a tripping hazard.
- The adjustable racks are designed to support cups, glasses and kitchen utensils. When the adjustable racks are in the DishDrawer® do not lean on or use them to support your body weight.
- To reduce the risk of injury, do not allow children to play in or on the DishDrawer®.
- Under certain conditions, hydrogen gas may be produced in a hot water heater system that has not been used for two weeks or more. **HYDROGEN GAS IS EXPLOSIVE.** If the hot water system has not been used for such a period, before using the dishwasher, turn on all hot water taps and let the water flow from each for several minutes. This will release any accumulated hydrogen gas. As the gas is flammable, do not smoke or use an open flame during this time.
- Remove the door to the washing compartment when removing an old dishwasher from service or discarding it.
- Some dishwasher detergents are strongly alkaline. They can be extremely dangerous if swallowed. Avoid contact with the skin and eyes and keep children away from the dishwasher when the door is open. Check that the detergent receptacle is empty after completion of the wash cycle.

Important safety instructions

Installation

- *This DishDrawer® must be installed and located in accordance with the Installation instructions before it is used. If you did not receive Installation instruction sheets with your DishDrawer®, you can order them by calling your Authorised Repairer or download them from our local Fisher & Paykel website, listed on the back cover.*
- *Installation and service must be performed by a qualified technician.*
- *If the power supply cord is damaged, it must be replaced by a dealer or Authorised Repairer or a similar qualified trades person in order to avoid a hazard.*
- *Ensure the DishDrawer® is secured to adjacent cabinetry using the brackets provided. Failure to do so may result in an unstable product, which may cause damage or injury.*
- *Do not operate this appliance if it is damaged, malfunctioning, partially disassembled or has missing or broken parts, including a damaged power supply cord or plug.*
- *Do not store or use petrol, or other flammable vapours and liquids in the vicinity of the DishDrawer®.*
- *Connect to a properly rated, protected and sized power supply circuit to avoid electrical overload.*
- *Make sure that the power supply cord is located so that it will not be stepped on, tripped over or otherwise subject to damage or stress.*
- *Do not install or store the DishDrawer® where it will be exposed to temperatures below freezing or exposed to weather.*
- *Do not use an extension cord or a portable electrical outlet device (e.g. multi-socket outlet box) to connect the DishDrawer® to the power supply.*
- *This appliance must be grounded. In the event of a malfunction or breakdown, grounding will reduce the risk of electric shock by providing a path of least resistance for electric current. This appliance is equipped with a cord having an equipment-grounding conductor and a grounding plug. The plug must be plugged into an appropriate outlet that is installed and grounded in accordance with all local codes and ordinances. WARNING - Improper connection of the equipment-grounding conductor can result in a risk of electric shock. Check with a qualified electrician or service representative if you are in doubt as to whether the appliance is properly grounded. Do not modify the plug provided with the appliance; if it will not fit the outlet, have a proper outlet installed by a qualified technician.*
- *If the DishDrawer® is installed as a permanently connected appliance:
GROUNDING INSTRUCTIONS - This appliance must be connected to a grounded metal, permanent wiring system, or an equipment-grounding conductor must be run with the circuit conductors and connected to the equipment-grounding terminal or lead on the appliance.*

Important safety instructions

Maintenance

- *Disconnect the appliance from the power supply before any cleaning or maintenance.*
- *Do not repair or replace any part of the appliance or attempt any servicing unless specifically recommended in this user guide. We recommend that you call an Authorised Repairer.*
- *Keep the floor around your appliance clean and dry to reduce the possibility of slipping.*
- *Keep the area around/underneath your appliance free from the accumulation of combustible materials, such as lint, paper, rags and chemicals.*

Important!

Under no circumstances should you open the drawer whilst the DishDrawer® is in operation.

Operational

- *Always press the ►|| button to pause and wait until you hear the three additional beeps before opening the drawer.*
- *The DishDrawer® must be used with the motor assembly, filter plate, drain filter and spray arm in place.*
- *When disconnecting the appliance pull the plug rather than the power supply cord or junction of cord to avoid damage.*
- *Take care when loading the DishDrawer® not to load dishware items so they prevent the lid from properly sealing with the drawer. Items should be placed so they do not protrude above and/or forced into the drawer, otherwise a service call may result.*
- *Household appliances are not intended to be played with by children. Children or persons with a disability which limits their ability to use the appliance, should have a responsible person instruct them in its use. The instructor should be satisfied that they can then use the appliance without danger to themselves or their surroundings.*
- *Close supervision is necessary if this appliance is used by or near children. Do not allow children to play inside, on or with this appliance or any discarded appliance.*
- *If a dishwasher cleaner is used, we would strongly recommend a wash programme with detergent should be run immediately afterward, to prevent any damage to the DishDrawer®.*
- *The DishDrawer® is designed for washing normal household utensils. Items that are contaminated by petrol, paint, steel or iron debris, corrosive, acidic or alkaline chemicals are not to be washed in the DishDrawer®.*
- *If the DishDrawer® is not being used for long periods of time, turn the electricity and water supply to the DishDrawer® off.*
- *Do not operate your appliance by means of an external timer or separate remote-control system.*

For Great Britain only

Important!

This appliance must be earthed.

Fuse replacement

The mains lead of this appliance is fitted with a BS 1363A 13 A fused plug. To change a fuse in this type of plug, use an ASTA approved fuse to BS 1362 type and proceed as follows:

- 1 Remove the fuse cover and fuse.
- 2 Fit the replacement 13A fuse into the fuse cover.
- 3 Refit both into plug.

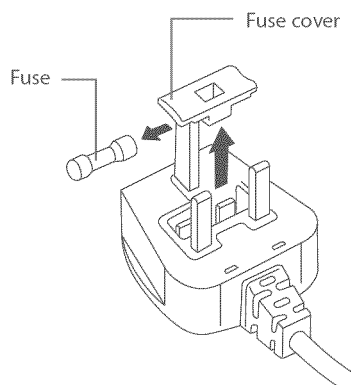

Important!

- *The fuse cover must be refitted when changing a fuse and if the fuse cover is lost, the plug must not be used until a correct replacement is fitted.*
- *Correct replacements are identified by the colour insert or the colour embossed in words on the base of the plug.*
- *Replacement fuse covers are available from your local electrical store.*

For the Republic of Ireland

The information given in respect to Great Britain will frequently apply, but a third type of plug and socket is also used: the 2-pin, side earth type.





Socket outlet / plug (valid for both countries)

If the fitted plug is not suitable for your socket outlet, please contact an Authorised Service Agent. Please do not attempt to change the plug yourself. This procedure must be carried out by a qualified service technician in compliance with the manufacturer's instructions and current standard safety regulations.

6 Operating instructions - Controls (models with no LCD)



If you have a double DishDrawer®, each drawer has its own controls and can run independently of the other.

Power button /

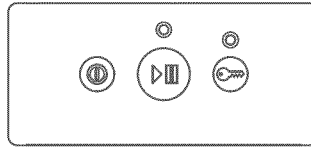
The  /  button turns the DishDrawer® on or off. Opening the drawer will automatically turn the DishDrawer® on for 30 seconds. To end a wash programme in mid cycle, press the  /  button. Any water in the DishDrawer® will be pumped out.



Start/Pause button



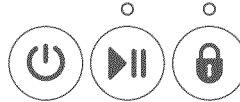

The  button starts a wash programme. Press the  button to pause or restart the DishDrawer® during a wash programme. When paused, wait for three beeps before opening the drawer. Forcing the drawer open while in mid cycle may cause damage or injury.





Delay start

The  button also sets the Delay start feature which can delay the start of a wash programme from 1 to 12 hours.

To activate Delay start

- 1 Press and hold the  button until the light above the  button turns orange or purple, depending on your model.
- 2 Continue holding the  button down until the desired delay time has been reached. The DishDrawer® will emit audible 'beeps' as you hold the  button down, each beep indicates another hour delay.
- 3 The DishDrawer® will start once the delay time has elapsed and the drawer is closed.

To cancel Delay start



Press the  /  button.

Lock button / (optional)

The  /  button activates/deactivates the Keylock or the Childlock functions.

Keylock



The Keylock feature disables all the buttons on the DishDrawer®.



To activate, press and hold the  button until you hear one beep (3 seconds). The light above the  button is lit when Keylock is activated.

To cancel the Keylock feature, press and hold the  button until the light above the  button disappears.

Childlock

The Childlock feature locks the drawer and disables all the buttons.

To activate, press and hold the  button until you hear two beeps (5 seconds). The light above the  button is lit when Childlock is activated.

To cancel the Childlock feature, press and hold the  button until the light above the  button disappears.

Wash programme selector

Press the  button to select a wash programme. The DishDrawer® will remember the last programme used.

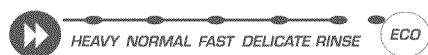

Wash programme selector (GB IE only)

Press the  button to select a wash programme. The DishDrawer® will remember the last programme used.

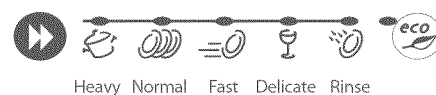

ECO / button (optional)

Press the ECO button if you would like the wash programme to use less energy. The red ECO light will indicate the feature is on. If your dishes are heavily soiled or you require enhanced dry performance, we do not recommend ECO programmes.

Power failure



If the DishDrawer® is operating and a power failure occurs, it will stop. The DishDrawer® may be unable to be opened during this time. When the power supply is resumed, the DishDrawer® will restart in the same part of the wash programme.

8 Operating instructions - Controls (models with LCD)

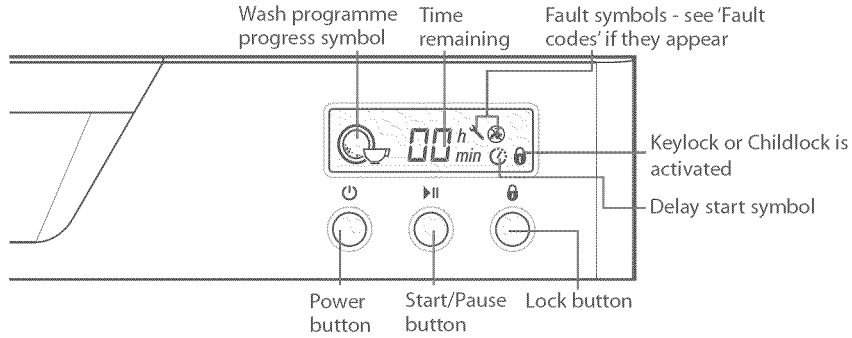

If you have a double DishDrawer®, each drawer has its own control panel and can run independently of the other.



Power button

The  button turns the DishDrawer® on or off. Opening the drawer will automatically turn the DishDrawer® on for 30 seconds. To end a wash programme in mid cycle, press the  button. Any water in the DishDrawer® will be pumped out.



Start/Pause button

The  button starts a wash programme. Press the  button to pause or restart the DishDrawer® during a wash programme. When paused, wait for three beeps before opening the drawer. Forcing the drawer open while in mid cycle may cause damage or injury.

Delay start

The  button also sets the Delay start feature which can delay the start of a wash programme from 1 to 12 hours.

To activate Delay start

- 1 Press and hold the  button until the delay symbol  appears on the electronic display.
- 2 Continue holding the  button down until the desired delay time has been reached.
- 3 The DishDrawer® will start once the delay time has elapsed and the drawer is closed.

To cancel Delay start



Press the  button.

Lock button (optional)

The  button activates/deactivates the Keylock or the Childlock functions.



Keylock



The Keylock feature disables all the buttons on the control panel.

To activate, press and hold the  button until you hear one beep (3 seconds). The  symbol appears in the electronic display when the Keylock feature is activated.

Childlock

The Childlock feature locks the drawer and disables all the buttons on the control panel.

To activate, press and hold the  button until you hear two beeps (5 seconds). The  symbol appears in the electronic display when the Childlock feature is activated.

To cancel the Childlock feature, press and hold the  button until you hear one beep and the  symbol disappears from the electronic display.

Wash programme selector

Press the  button to select a wash programme. The DishDrawer® will remember the last programme used.



Wash programme selector (GB IE only)

Press the  button to select a wash programme. The DishDrawer® will remember the last programme used.

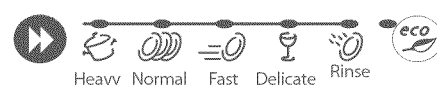

ECO / button (optional)

Press the ECO button if you would like the wash programme to use less energy. The red ECO light will indicate the feature is on. If your dishes are heavily soiled or you require enhanced dry performance, we do not recommend ECO programmes.

Wash programme progress symbols

As the wash programme advances through the cycle, the following symbols will appear in the electronic display to indicate the progression. When a wash programme has started, the electronic display also will count down the time remaining in one minute increments.



Power failure

If the DishDrawer® is operating and a power failure occurs, it will stop. The DishDrawer® may be unable to be opened during this time. When the power supply is resumed, the DishDrawer® will restart in the same part of the wash programme.

10 Operating instructions - Quick start

1 Load dishes

Remove all food scraps and load the dishes.

2 Add detergent

3 Check rinse aid

4 Press the / button

5 Select a wash programme

The length of the wash programme will appear on the electronic display (models with LCD only).

6 Select ECO (optional)

7 Check

Ensure there is nothing obstructing the spray arm. The drain filter must be level with the filter plate.

Note: to identify these parts, see illustrations in 'User maintenance instructions'.

8 Start

Close the drawer and press the  button.

9 Finish

The DishDrawer® will beep six times to indicate the end of the wash programme. At the end of the wash programme the drying fan will continue to run for a set time or until the drawer is opened. The fan assists with drying and uses negligible amounts of energy. It is normal for some water to remain in the drain filter area after the wash programme is complete.

Double models only: At the end of a wash programme, you may find both drawers draining simultaneously. This is normal.

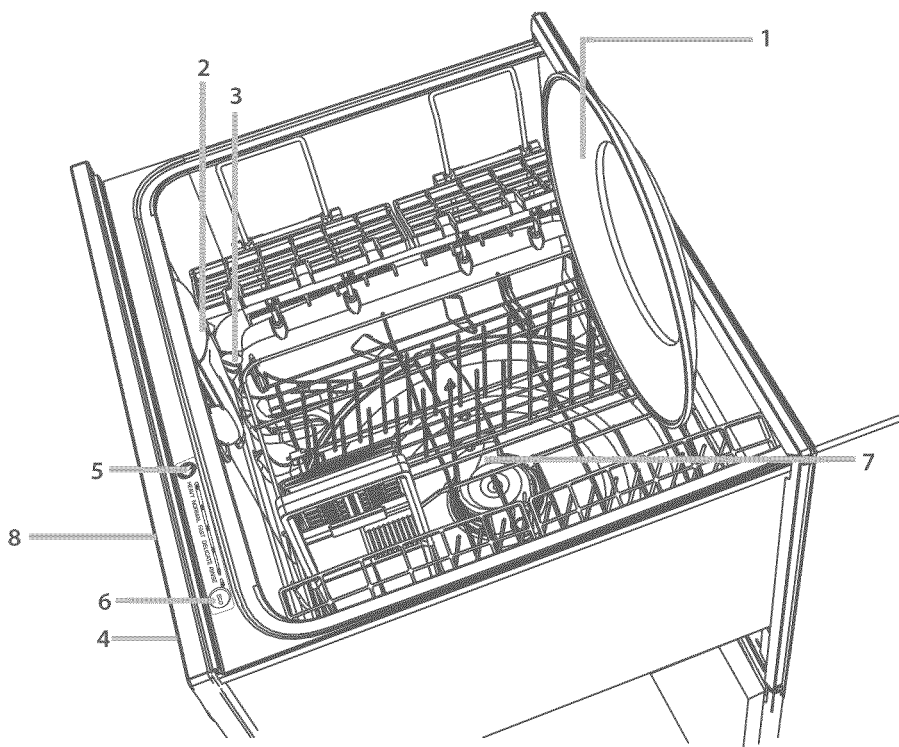

The combination of high temperatures and dishwasher detergent may cause damage to some items if they are washed in the DishDrawer®. Remember, if in any doubt about any aspect concerning items washed in the DishDrawer®, follow the instructions from the manufacturer of the items, or wash the item by hand.

Cutlery & silverware

All cutlery and silverware should be rinsed immediately after use to prevent tarnishing caused by some foods. The Rinse wash programme is useful for this. Silver items should not come into contact with stainless steel, eg other cutlery. Mixing these items can cause staining. Remove silver cutlery from the DishDrawer® and hand dry it immediately after the programme has finished.

Aluminium

Aluminium can be dulled by dishwasher detergent. The degree of change depends on the quality of the product.

Other metals

Iron and cast iron objects can rust and stain other items. Copper, pewter and brass tend to stain.

Woodware

Wooden items are generally sensitive to heat and water. Regular use in the dishwasher may cause deterioration over time. If in doubt, wash by hand.

Glassware

Most everyday glassware is dishwasher safe. Crystal, very fine and antique glassware may etch that is, become opaque. You may prefer to wash these items by hand.

Plastic

Some plastic may change shape or colour with hot water. Check manufacturer's instructions about washing plastic items. Washable plastic items should be weighed down so they do not flip over and fill with water or fall through the base rack during the wash. Use the multi-purpose clip to hold plastic items in place.

Decorated items

Most modern china patterns are dishwasher safe. Antique items, those with a pattern painted over the glaze, gold rims or hand painted china may be more sensitive to machine washing. If in doubt, wash by hand.

Glued items

Certain adhesives are softened or dissolved in machine washing. If in doubt, wash by hand.

Holiday time

If the DishDrawer® is not going to be used for some time, we recommend you leave the DishDrawer® clean and empty. Leave the drawers ajar to allow air to circulate. Turn off both the power and water supply to the DishDrawer®.

12 Racking and accessories

Cutlery basket

- To reduce the risk of injury, we recommend loading knives and sharp utensils with handles facing up.
- Mix spoons, knives and forks within each section to stop cutlery nesting together and to ensure the water circulates freely.
- Keep stainless steel from touching silver cutlery to avoid staining.

Removable small items container

- Small, light items like baby bottle teats are best placed into the small items container to prevent them from being displaced during the wash.

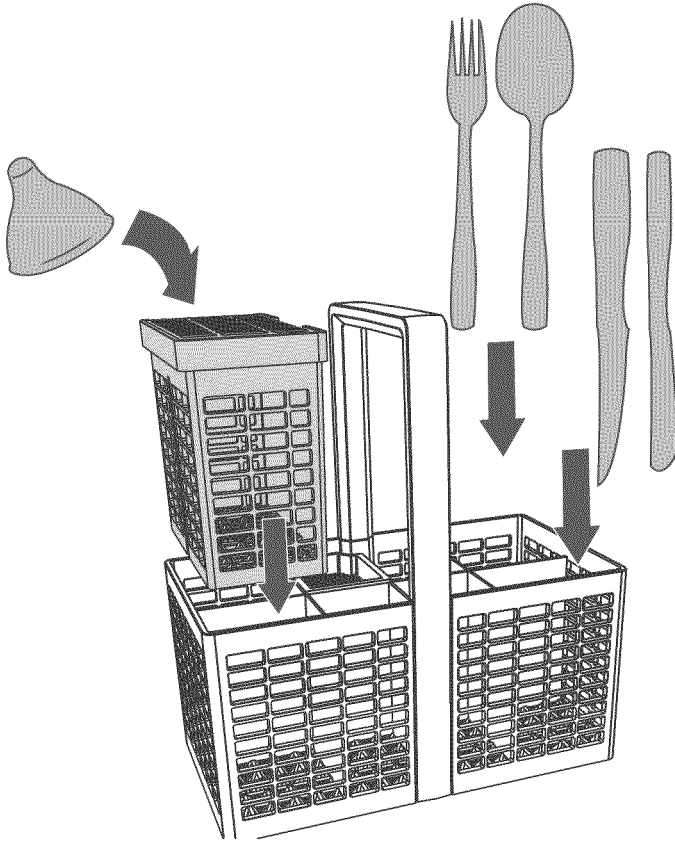

Removable small items container

- To optimise the cutlery space within the basket, the small items container can be placed elsewhere on the base rack. If laid flat, make sure the solid plastic side is facing up.
- If you place a fully laden small items container under the adjustable racks, it is best to leave the rack space directly above the container empty: there may not be enough water reaching items that are placed there.

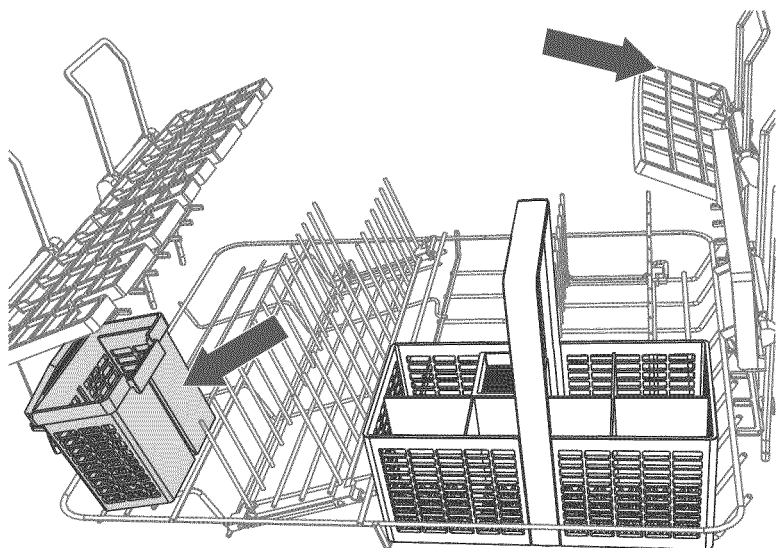
**Removable tablet tray**

- If you are using dishwasher tablets, place them on the removable tablet tray, as shown. See also 'Using tablets' for more information.
- We do not recommend using tablets in USA and Canada models. The pre-wash cycle in these models would dissolve the tablet, reducing the cleaning power left for the main wash.

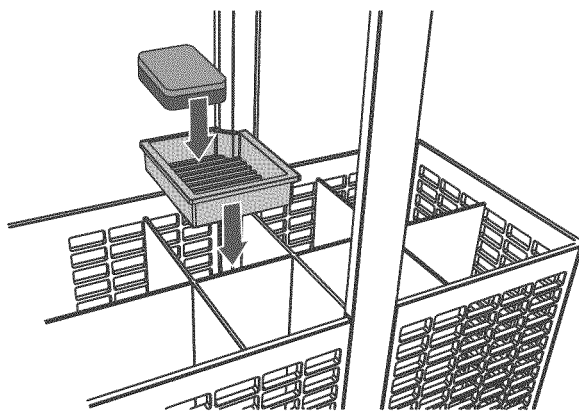

14 Racking and accessories

Stemware notches

- These notches help support long-stemmed glassware.

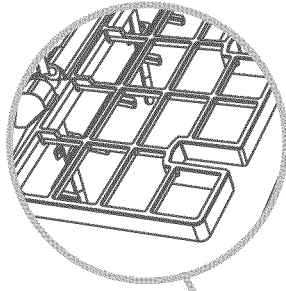

Glass supports

- These clip on the rack wires to give your tall glasses extra stability.

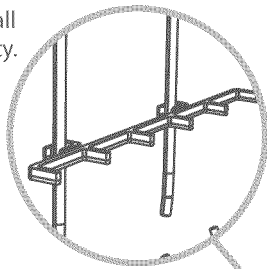

Folding tines

- The front half is ideal for large, deep bowls.
- Fold the tine sections down towards each other if you need space for pots or other large items.
- Fold down the right-hand section only and lean cups against the upright tines for extra stability.

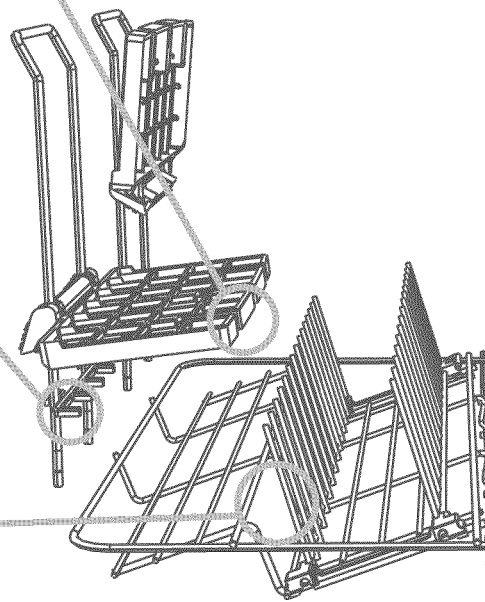

Adjustable racks

- You can adjust these independently of each other to any height:
 - 1 Fold up to unlock the rack.
 - 2 Adjust the height to suit by sliding up or down.
 - 3 Fold down to lock in position.
- Fold the racks away if you need the space.

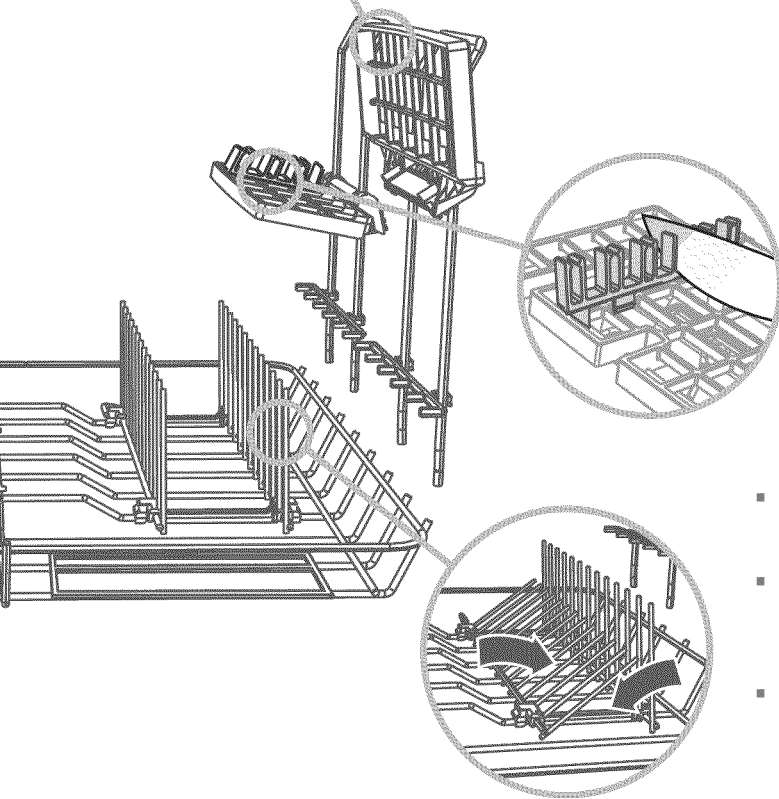
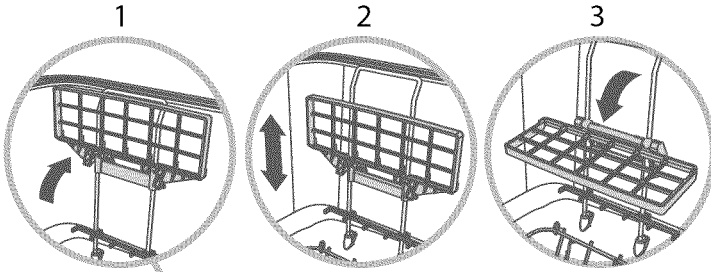

Knife clip (supplied with some models only)

- This clips onto the adjustable racks and supports knives and other utensils during the wash.
- Always ensure that knife blades are facing down.

'Slide-and-fold' tines

- Slide all the way to the left to fit larger dinner plates.
- For optimum stability, place larger plates between the longer tines in the front.
- Fold the tine sections down towards each other if you need the space for pots or other large items.

16 Loading suggestions

When loading your DishDrawer®, make sure that

- you place items so that water coming from the rotating spray arm below can reach all areas (wash performance will be reduced if it can't)
- nothing blocks the water from getting to items on the adjustable racks.

Typical breakfast load

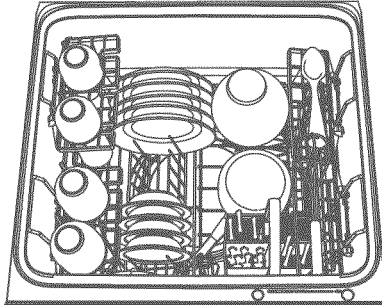

Typical dinner party load

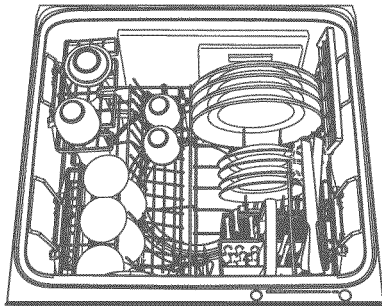

Typical heavy load

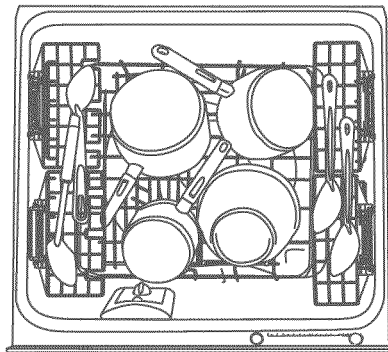

How NOT to load your DishDrawer®

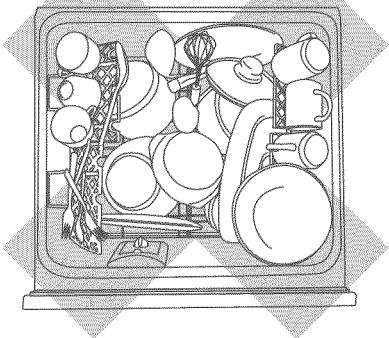

- Overcrowded and wash water will not reach some of the dinnerware.
- Cups, glasses and bowls must have their openings facing down.

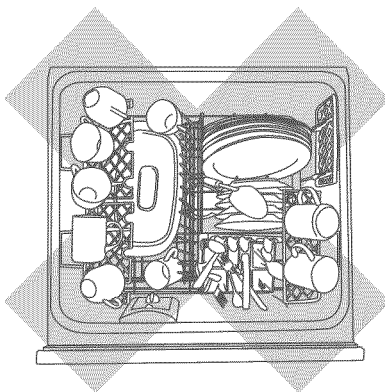

- The plates are nesting together and wash water may not get through.
- Ensure cutlery are not nesting or stuck together. They need to be evenly spread out.

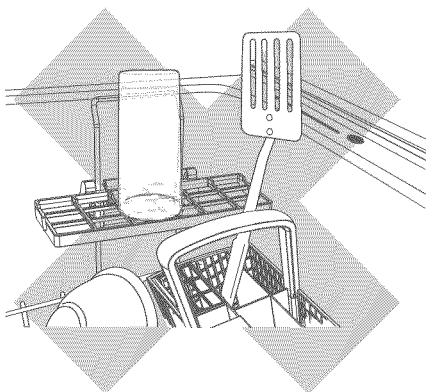

- Ensure dishware items are not forced into or protrude out of the drawer, as this may prevent the lid from properly sealing which could result in a service call.
- Locate sharp items safely to prevent injuring the user and damaging the lid assembly.
- Check the bottom of the cutlery basket to ensure sharp or pointed items have not come through as they may stop spray arm rotation.

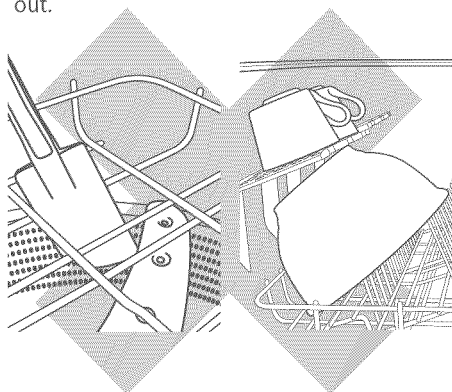

- Ensure cutlery has not fallen through the base rack and stopped the spray arm from rotating.
- The large bowl is blocking wash water reaching the adjustable racks.
- Large utensils should be on the adjustable racks so they do not become dislodged and stop the spray arm from rotating.
- Sharp or pointed items must be placed horizontally or with sharp edges/points facing down to avoid risk of injury.

What is water hardness?

Hard water is water with a high concentration of minerals such as calcium and magnesium. In soft water, this concentration is low. Water hardness varies by geographical location.

How does water hardness affect dishwashing?

- Hard water can be detrimental to the performance of your DishDrawer. Over time, glassware washed in hard water will become opaque and dishes will become spotted or covered in a white film. Using very hard water can cause DishDrawer parts to fail over time.
- Naturally soft or softened water has no detrimental effects if used with the correct amount of detergent. However, excess detergent combined with hot, soft water may cause irreversible etching on glassware. Etching first appears as a rainbow-coloured film and—if allowed to continue—can make glassware permanently opaque.

What can I do to minimise any detrimental effects?

Contact your local water company to find out about water hardness in your area.

If your home has hard water and your DishDrawer has no built-in water softener...

- Follow the detergent quantity recommendations on the following page.
- Use a detergent with high phosphate content. Phosphate softens the water and this improves wash results.
- Use rinse aid. We recommend you turn the rinse aid setting to 5 to help improve wash performance.
- Use a dishwasher cleaner/descaler regularly, or whenever you notice a build-up of limescale deposits in your DishDrawer.

- ***Important!***

We recommend fitting a water softener to the household water supply. If the water hardness in your home is above 250 ppm/14.6 gpg, a water softener has to be fitted to maintain the performance of your DishDrawer.

If your home has naturally soft or softened water...

- Avoid using too much detergent. Follow the quantity recommendations on the following page.
- Ensure the DishDrawer is not overloaded and water can reach all the dishes.

Wash programmes

Heavy <i>Heavily soiled pots, pans and dishes.</i>	Normal <i>Dishes with normal soils for optimum wash and dry performance.</i>	Fast <i>Lightly soiled dishes.</i>	Delicate <i>Lightly soiled and heat-sensitive crockery.</i>	Rinse <i>Prevents odours and soils drying on dishes.</i>
All programmes except Rinse can be used in ECO mode to save energy. If your dishes are heavily soiled or you require enhanced dry performance, we do not recommend ECO programmes. See section 'Operating instructions – Controls' for wash programme selection.				

Detergent quantities

- Find out about water hardness in your home, then use the table below to determine how much detergent to use for each wash programme. See also section 'Water hardness and dishwashing'.
- The detergent dispenser has markings to help you measure the correct quantities. See following section 'Detergent dispenser'.

	Water hardness <i>parts per million (ppm)</i> <i>grains per gallon (gpg)</i>	Wash programmes	Detergent quantities (per drawer)			
			US CA		NZ AU	GB IE
			<i>pre-wash</i>	<i>main wash</i>	<i>main wash</i>	<i>main wash</i>
			<i>teaspoons</i>		<i>teaspoons</i>	<i>teaspoons</i>
SOFTER	<100 ppm or < 6 gpg*	Heavy	1	3	4	4
		Normal	1	2	3	3
		Fast	-	1	1	1
		Delicate	-	1	1	1
		Rinse	-	-	-	-
	100 -150 ppm or 6 - 9 gpg	Heavy	2	4	6	
		Normal	2	4	6	
		Fast	-	4	4	
		Delicate	2	4	6	
		Rinse	-	-	-	
	>150 ppm or >9 gpg	Heavy	2	6	6	
		Normal	2	6	6	
		Fast	-	6	6	
		Delicate	2	6	6	
		Rinse	-	-	-	
HARDER						

* If you have a household water softener installed or your DishDrawer has a built-in water softener (US CA: DD24-H models only, GB IE: all models), use the quantities recommended for water with a **hardness under 100 ppm/6 gpg**, irrespective of the water hardness in the area. See also section 'Water softener'.

Important!

- Only use powdered detergent recommended for domestic automatic dishwashers in the detergent dispenser.
- Dishwasher detergents are strongly alkaline. They can be extremely dangerous if swallowed. Avoid contact with the skin and eyes and keep children and infirm persons away from the DishDrawer when it is open. Check that the detergent dispenser is empty after completion of the wash programme.
- Do not place dishwasher tablets in the detergent dispenser.
- Detergent and dishwasher tablets should not be in direct contact with dishes or cutlery.
- Liquid detergents are not suitable to be used in the DishDrawer®.
- Hand washing liquids, soap, laundry detergents or disinfectants will damage the DishDrawer®.

Filling the detergent dispenser

- 1 Press the latch down and the dispenser will open.
- 2 Pour detergent into the appropriate compartment(s). Use the markings to help you measure the correct quantities. No detergent is needed for the Rinse programme.
- 3 Close the dispenser until it clicks shut. The detergent will automatically be released into the DishDrawer® during the wash programme.

Amount of detergent to use

Refer to previous section 'Wash programmes and detergent quantities', and follow the quantities relevant to your location and water hardness level.

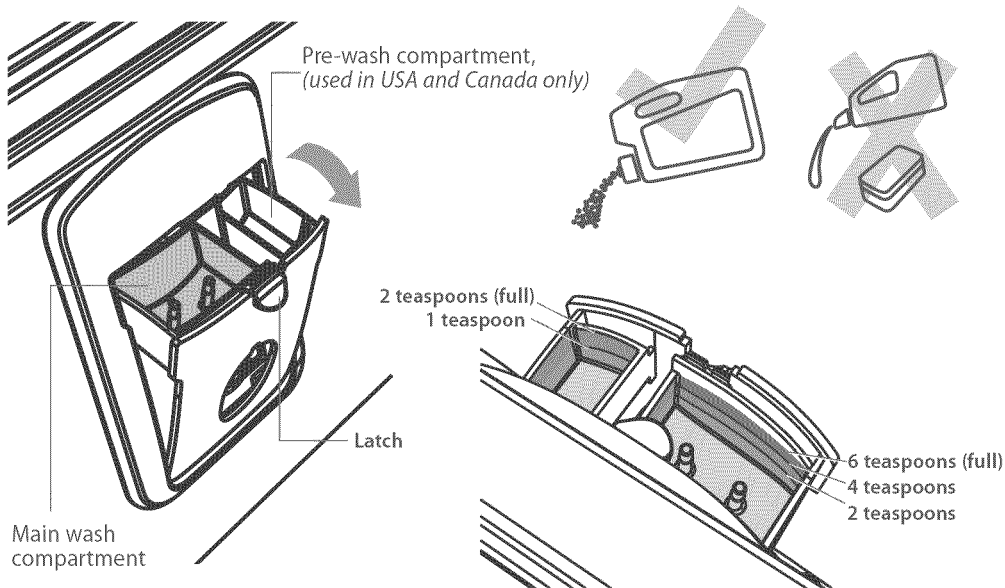

Important!

- We do not recommend using dishwasher tablets in USA and Canada models. The pre-wash cycle in these models would dissolve the tablet, reducing the cleaning power left for the main wash.
- If you are using tablets, we highly recommend you use the standard Normal or Heavy programmes only. We do not recommend you use the Fast, Delicate, or any wash programme using less than 50 °C (see section 'Wash programme data'). Follow the instructions of the tablet manufacturer for optimum performance.
- Using tablets could improve wash performance in hard water areas.

Tablets can either be placed in the cutlery basket or alternatively, placed directly in the wash compartment as below. If you are using dishwasher tablets with a built-in rinse aid component, you may need to reduce the rinse aid setting. See 'Option adjustments' for instructions.

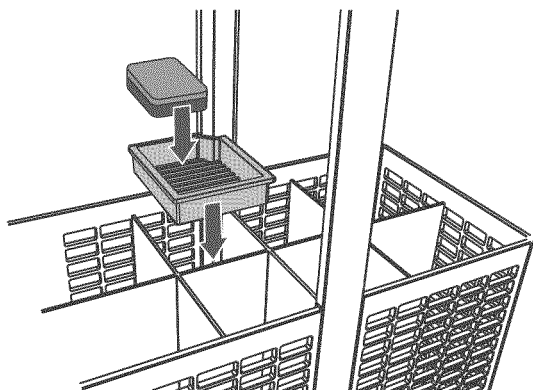
**Preferred:**

Place the tablet on the removable tablet tray.

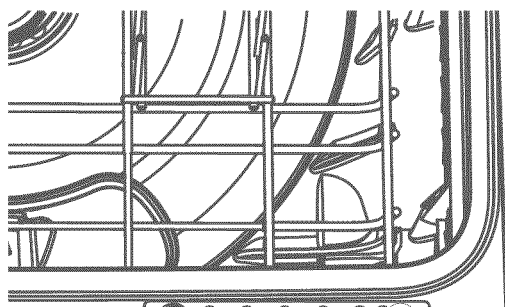
**Alternative:**

If the cutlery basket cannot be used, place tablet in the bottom of the DishDrawer.

22 Rinse aid dispenser

We highly recommend the regular use of liquid rinse aid to give the best drying results. Rinse aid gives a streak-free, sparkling clean look to glass and chinaware. In addition, it prevents metal from tarnishing. The rinse aid dispenser is on the inside of the drawer, located underneath the detergent dispenser. The rinse aid dispenser holds approximately 1.7 fl oz / 50 ml of rinse aid.

Filling the rinse aid dispenser

- 1 Turn the plug anticlockwise and remove.
- 2 Pour the rinse aid into the circular opening.
- 3 Take care not to spill rinse aid into the DishDrawer®.

Important!

Any spillages must be wiped up to prevent excess foaming. Failure to wipe rinse aid spillages may result in a service call which will not be covered by warranty.

- 4 Fit the plug back into the original position.

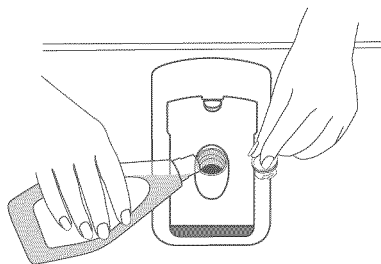

How much rinse aid to use

The regulator may need adjusting to suit your water conditions or the particular dishwasher tablet you are using. The lowest setting is '1' and the highest is '5'. Refer to the 'Option adjustments' section to adjust the rinse aid setting.

- If there is excessive foam at the end of the wash or you are using dishwasher tablets with built-in rinse aid, reduce the setting.
- If dishes are wet or streaky after drying, increase the setting.
- If you live in a hard water area and you have no water softener installed in your water supply or built into your DishDrawer, we recommend adjusting the rinse aid setting to 5.

Rinse aid indicator light

If the rinse aid indicator light is red, refill the dispenser.
If the rinse aid indicator light is dimly lit or not lit at all, there is enough rinse aid for the wash.

Note:

- Lighter coloured rinse aids will not dim the indicator light as effectively as darker coloured rinse aids.
- When the rinse aid is being dispensed, you may notice some unusual noises during the wash: this is normal.

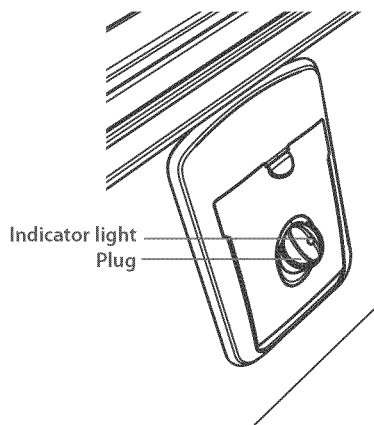

Setting up the water softener

Important!

Only some models (DD24-H and DD60-H) have a built-in water softener.

Models with water softener are not currently available in New Zealand and Australia.

Determine the water hardness in your local area

Your local water company will be able to provide you with information. Identify the setting you require for your DishDrawer® from the water hardness table below. For example, if your water hardness is 500ppm, then the water softener setting on your DishDrawer® should be 4. Refer to the 'Option adjustments' section to adjust the water softener so that the setting corresponds to your water hardness.

DishDrawer® setting	Parts per million (ppm)	Grains per gallon (gpg)	°dH	°fH	°e / °Clark	mmol/l
0	0 - 100	0 - 6	0 - 5.6	0 - 10	0 - 7	0 - 0.1
1	100 - 250	6 - 14	5.6 - 14	10 - 25	7 - 17.5	0.1 - 2.5
2	250 - 350	14 - 20	14 - 19.6	25 - 35	17.5 - 24.5	2.5 - 3.5
3	350 - 450	20 - 26	19.6 - 25.2	35 - 45	24.5 - 31.5	3.5 - 4.5
4	450 - 550	26 - 32	25.2 - 30.8	45 - 55	31.5 - 38.5	4.5 - 5.5
5	550 - 625	32 - 36	30.8 - 35	55 - 62	38.5 - 43.8	5.5 - 6.2

24 Water softener

Notes:

- If your water hardness is above 625ppm, we highly recommend you completely fill the appropriate compartment(s) of the detergent dispenser for all programmes except Rinse and the rinse aid setting should be at 5. If your water hardness is above 625ppm, the wash performance of your DishDrawer® will decline.
- You may hear some unusual noises when the water softener is in operation, this is normal.

How to fill the salt reservoir

- 1 Open the DishDrawer®.
- 2 Unscrew the salt reservoir cap by turning anticlockwise.
- 3 Place the salt into the salt container and pour the contents into the salt reservoir. The salt reservoir can hold up to approximately 1 lb/0.5 kg of salt.
- 4 Fit the cap tightly back into its original position.
- 5 If you do not wash your dishes immediately after filling the salt reservoir, run a Rinse programme to remove any salt water or spilt granules.

Note:

When filling the salt reservoir, you may notice water being displaced from the water softener overflow.

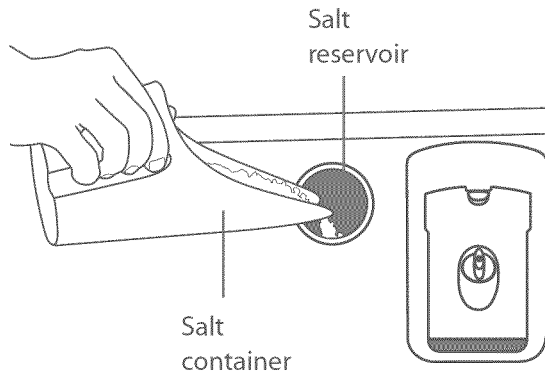

Important!

The water softener must always be filled with granular salt made especially for dishwasher water softening systems. We do not recommend the use of cooking salt like table salt, rock salt or pellets as they may contain impurities that will impair or diminish the life of the water softener.

The salt reservoir

Water softening can only take place when there is salt in the reservoir. The salt reservoir must be filled prior to using the DishDrawer® and whenever the salt indicator light is red.

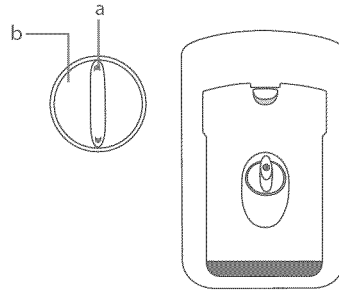

a Salt indicator light
b Salt reservoir cap

Salt indicator light

- If the salt indicator light is red, the salt reservoir is empty.
- If the salt indicator light is black, there is enough salt in the reservoir for the wash programme that has been selected.
- Models with LCD only: The electronic display will also indicate when the salt reservoir is empty by displaying the salt **S** symbol.

Important!

Do not pour detergent or rinse aid into the salt reservoir. Detergent and rinse aid will destroy the water softener.



Salt only

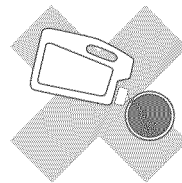

NO Detergent

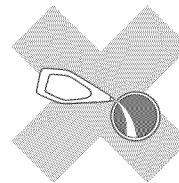

NO Rinse Aid

26 Option adjustments

The following options can be adjusted to suit your preferences:

Rinse aid setting

Reduce the Rinse aid setting if there is excess foam after a wash programme or if you are using dishwasher tablets with built-in rinse aid.

Increase the Rinse aid setting if dishes are wet or streaky after a wash programme.

Water softener setting

Refer to the 'Water softener' section.

Auto power setting

By default, DishDrawer® will automatically turn on whenever the drawer is opened. Washing will not start until the drawer is closed and the ►|| button has been pressed. If you do not want the DishDrawer® to turn on automatically, this feature can be turned off.

End of wash programme beeps

By default, DishDrawer® will beep six times at the end of a wash programme. This feature can be turned off.

Closed drawer option

The Closed drawer option will lock the DishDrawer® when the drawer is closed. When you wish to open the drawer, press the ◀ / Ⓛ button. When the drawer is fully closed again, the lid will automatically come down after 30 seconds and lock.

If the Keylock feature is used in conjunction with the Closed drawer option, pressing the ◀ / Ⓛ button will not unlock the drawer. The Keylock feature must be turned off to enable DishDrawer® to be opened.

Note: this option is highly recommended if the DishDrawer® is to be used in motor homes.

Clean dish indicator option (models with LCD only)

By default, DishDrawer® is programmed with the Clean dish indicator option off. When the Clean dish indicator option is on, the ☐☐ symbol will remain in the electronic display after a wash programme has finished to indicate the dishes are clean. When you have unloaded all the dishes, press the ◀ button to return to normal operating mode.

This option might be useful when dishes have been left in DishDrawer® and you cannot remember if they have been washed or in situations where household members regularly remove only a few clean dishes without emptying the drawer.

We do not recommend the Clean dish indicator option be used in conjunction with the Closed drawer option.

















How to make option adjustments (models with no LCD)

FIRST	Enter Option adjustment mode: 1 Press the / button to turn power on. Open DishDrawer®. 2 Press and hold the <i>ECO</i> / and buttons for 5 seconds until one long beep sounds.				
FOLLOW THE STEPS BELOW	<i>Rinse aid setting</i>	<i>Water softener setting*</i>	<i>Auto power option</i>	<i>End of wash programme beeps option</i>	<i>Closed drawer option**</i>
PRESS THE ▶ BUTTON TO SCROLL THROUGH OPTIONS	Prefinished red / unlit Integrated red / unlit /	blue / unlit green / unlit /	purple / lit orange / lit /	blue / lit green / lit /	red / lit red / lit /
	The current setting is shown on the wash programme selector in red lights. If four red lights are lit, the option selected setting is set to 4. Press the button to increase the setting.	Press the button to turn the selected option on or off.			
MAKE AN ADJUSTMENT	Press the / button to save the change.				
SAVE					
EXAMPLE	Setting set to 4 	On Off	On Off	On Off	

* This option is disabled on models without water softener. It appears in the sequence of options but cannot be adjusted.

** The option sequence will start again from the Rinse aid setting.

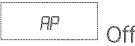
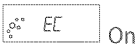
How to make option adjustments (models with LCD)

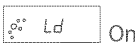
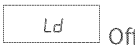
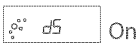
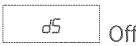
FIRST	Enter Option adjustment mode: 1 Press the  button to turn power on. Open DishDrawer®. 2 Press and hold the <i>ECO</i> /  and  buttons for 5 seconds until one long beep sounds.						
FOLLOW THE STEPS BELOW	<i>Rinse aid setting</i>	<i>Water softener setting*</i>	<i>Auto power option</i>	<i>End of wash programme beeps option</i>	<i>Closed drawer option</i>	<i>Clean dish option**</i>	
PRESS THE  BUTTON TO SCROLL THROUGH OPTIONS							
MAKE AN ADJUSTMENT	The current setting is shown on the wash programme selector in red lights. If four red lights are lit, the option selected setting is set to 4. Press the  button to increase the setting.			Press the  button to turn the selected option on or off.			
SAVE	Press the  button to save the change.						
EXAMPLE	 Setting set to 4			 On  Off	 On  Off	 On  Off	 On  Off

* This option is disabled on models without water softener. It appears in the sequence of options but cannot be adjusted.

** The option sequence will start again from the Rinse aid setting.

Important!

Disconnect the DishDrawer® from the power supply and allow all its parts to cool before any cleaning or maintenance.

Cleaning the surfaces

Important!

We do not recommend the use of the following cleaning aids on your DishDrawer® as they may damage the surfaces:

- Plastic or stainless steel scouring pads
- Acid or alkaline cleaners
- Stainless steel cleaners or polishes
- Abrasive, solvent, household cleaners
- Hand washing liquids or soap
- Laundry detergents or disinfectants

- 1 Wipe with a clean damp cloth. Take care not to wet the control panel.
- 2 Dry with a clean lint-free cloth.

Cleaning the drain filter, spray arm and filter plate

- We recommend that the drain filter is cleaned whenever there is evidence of food particles.
- The spray arm may need cleaning about once a month in normal use or more often should the need arise.

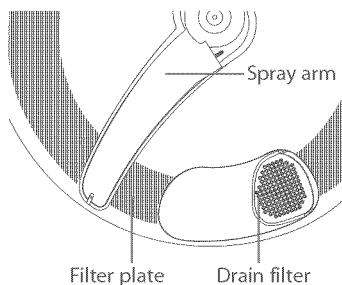

Important!

- If a dishwasher cleaner/descaler is used, you must run a wash programme with detergent immediately afterward to prevent any damage to your DishDrawer®.
- The DishDrawer® must be used with the filter plate, drain filter and spray arm correctly in place.

Cleaning the drain filter

- 1 Unplug the DishDrawer® or turn it off at the power supply.
- 2 Lift up the drain filter access panel on the base rack (if fitted).
- 3 Lift and remove the drain filter. It is normal to find some water under it.
- 4 Empty, rinse clean under running water and replace back into the allocated space.
- 5 Ensure the drain filter is flush with the filter plate.
- 6 Plug the DishDrawer® back in or turn it on at the power supply.

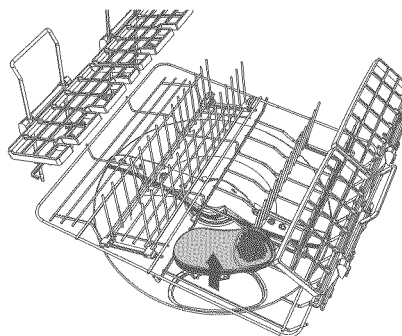
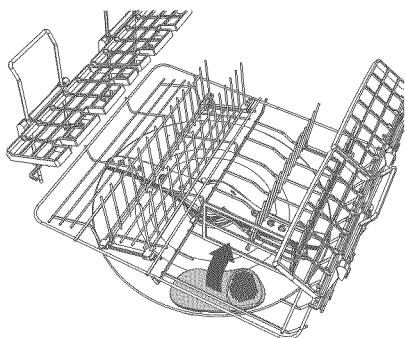

Cleaning the spray arm and filter plate

To remove and clean the spray arm and filter plate

- 1 Unplug the DishDrawer or turn it off at the power supply.
- 2 Unclip the glass supports from the rack wires and fold all the adjustable racks away, so that they are upright and close to the top.
- 3 Remove the base rack carefully. Lift from the back end first to prevent knocking the detergent and rinse aid dispenser.
- 4 Lift the spray arm and shake any foreign material out. Rinse it clean under running water and wipe with a damp cloth.
- 5 Lift and remove the drain filter.

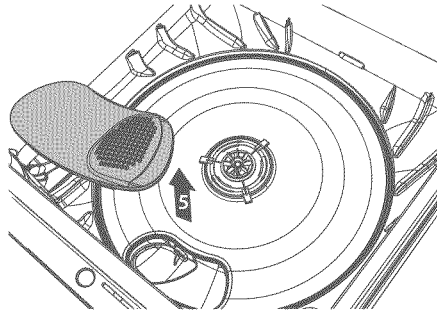
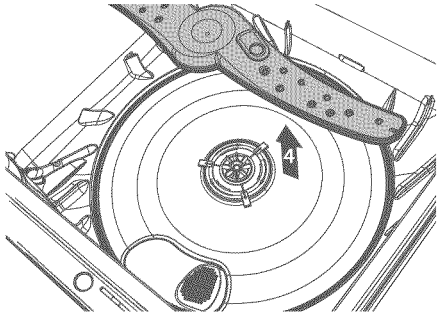
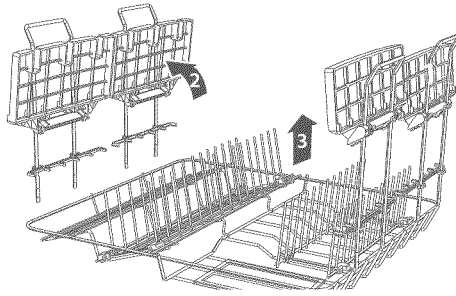

- 6 In the centre of the filter plate there are two rings. Turn the outer ring anticlockwise, about a 1/8 turn. This will release the filter plate.
- 7 Lift the filter plate out. Remove any foreign material, wash in hot soapy water and rinse thoroughly in clean water, then wipe with a damp cloth. Take care handling the sharp outer edge of the filter plate.

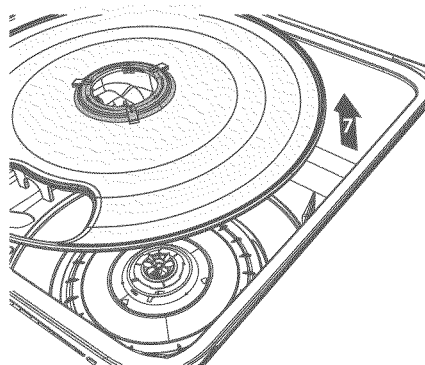
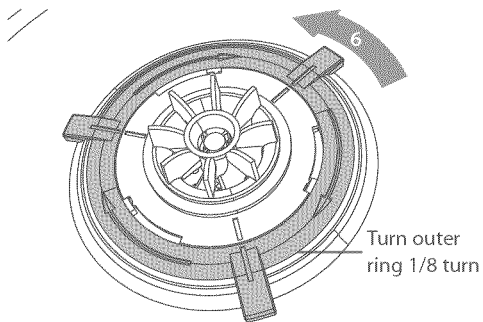

To replace the filter plate and spray arm

- 8 Some models only: Before replacing the filter plate, ensure the O-ring is correctly positioned on the motor assembly, as shown.
- 9 Orientate the filter plate and lower it into place: make sure its kidney-shaped hole aligns with the matching recess in the DishDrawer base.
- 10 Ensure the filter plate lies flat in the base, then lock it into position: turn the outer ring clockwise until the the marks align with each other and all three pin pairs firmly interlock, as shown.

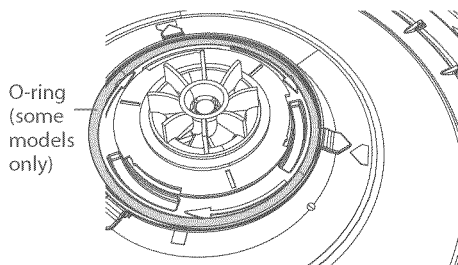

Important!

The filter plate must not be able to move about freely.

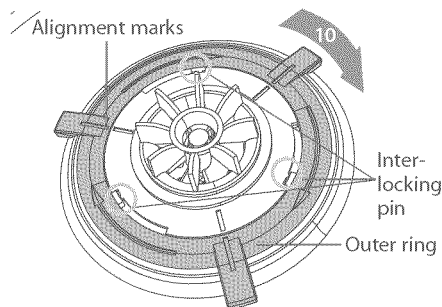
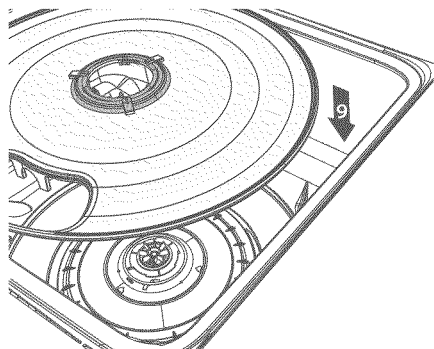



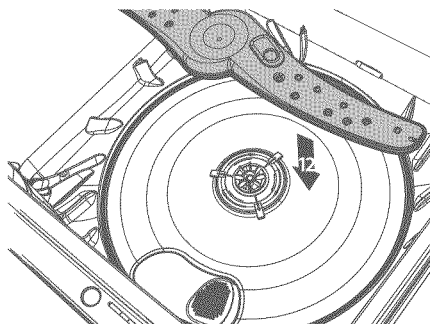
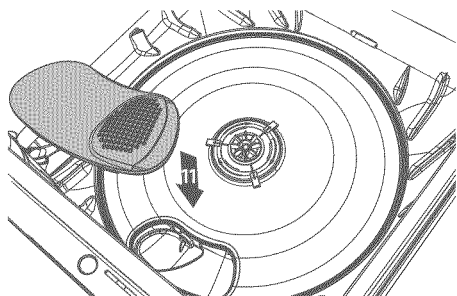

- 11 Replace the drain filter, ensuring it is flush with the filter plate.
- 12 Replace the spray arm back onto the impeller.



- 13 Replace the base rack, lowering its front edge into position first.
- 14 Plug the DishDrawer back in or turn it on at the power supply.

Note: Where there is broken crockery or glass in the drawer, it must be carefully removed to prevent damage to the DishDrawer.

Problem	Possible cause	What to do
Unclean dishes	Wash programme unsuitable for the load.	See section 'Wash programmes and detergent quantities' for a suitable wash programme, or the soils were too heavily baked on and dishes may need soaking.
	Spray arm unable to rotate.	Ensure no items are obstructing the spray arm path.
	DishDrawer® overloaded/incorrectly loaded.	Refer to the section on loading.
	Filter plate/drain filter is incorrectly inserted.	See section 'User maintenance instructions'
	Detergent put in the wrong compartment of the dispenser.	Detergent for the main wash must be placed in the large compartment. See section 'Detergent dispenser' for information.
	Excess food not removed from dinnerware prior to loading.	Scrape all food scraps off dinnerware prior to loading.
	Unsuitable detergent.	Use recommended brands of dishwasher detergent.
	Not enough detergent.	See section 'Wash programmes and detergent quantities' or follow the detergent manufacturer's instructions.
	Spray arm holes are blocked.	Clean the spray arm.
Foaming	Filter plate/drain filter is blocked.	Clean the filter plate and drain filter.
	Incorrect amount of detergent.	See section 'Wash programmes and detergent quantities' or follow the detergent manufacturer's instructions.
	Too much egg in the wash load.	Increase the amount of detergent.
Water leaking	Rinse aid setting too high.	Decrease the rinse aid setting.
	Drain hose disconnected from waste pipe.	Reconnect the drain hose to the waste pipe.
	Water inlet hose not properly connected.	Ensure the inlet hose is connected securely.
DishDrawer® will not open	Other leaks.	Turn water and power supplies to the DishDrawer® off. Call your dealer or Authorised Service Centre.
	Childlock feature is on or the Closed drawer option is on, or both.	Turn the Childlock off. Hold down the  button until the  symbol disappears from the LCD screen or the light above the  button disappears and/or press the  /  button to open the DishDrawer®.
Power failure during cycle		Wait until power resumes, cycle will restart in same part of wash programme.

Problem	Possible Cause	What to do
Continuous beeping	A fault has occurred.	Refer to the 'Fault codes' section.
Intermittent beeping	DishDrawer® is in pause mode.	Close the DishDrawer® and press the ▶ button.
DishDrawer® will not start	Power supply is not connected.	Connect the power supply.
	The drawer is not closed properly.	Ensure the drawer is firmly closed.
	Keylock or Childlock feature is on.	Turn the Keylock or Childlock off. Hold down the 🔒/🔒 button until the 🔒 symbol disappears from the LCD screen or the light above the 🔒/🔒 button disappears.
	▶ button not pressed.	Press the ▶ button.
Water under the drain filter	This is normal and needs no action.	
Excess water in the DishDrawer®	Drain hose(s) bent or kinked.	Straighten the drain hose(s).
	Blocked filters.	Clean the filter plate/drain filter. Refer to the 'User maintenance instructions' section.
Water marks on the dishes	Rinse aid depleted.	Refill the rinse aid dispenser.
	Rinse aid setting too low.	Increase the rinse aid setting.
	DishDrawer® overloaded/incorrectly loaded.	Refer to the section on loading.
DishDrawer® interior is stained	Some foods, like tomato based products, may stain the inside of the DishDrawer®.	Pre-rinse dishes before placing in the DishDrawer®. Alternatively, using the Rinse programme after adding the dishes may minimise staining.
Dishes did not dry	Incorrect loading.	Ensure the dishes are not nesting together.
	Rinse aid depleted.	Refill the rinse aid dispenser.
	Rinse aid setting too low.	Increase the rinse aid setting.
	Eco wash programme used.	Choose a standard wash programme.
No detergent dispensed	Detergent dispenser was wet when loaded.	Clean the dispenser and ensure the dispenser is dry when adding detergent.
Excessive motor noise	The filter plate and/or spray arm is incorrectly placed.	Refer to the 'User maintenance instructions' section for details on correct placement.
	No water in the motor area.	This usually occurs on the first use or when the DishDrawer® has not been used for long periods of time. Run the DishDrawer® through a wash programme.







How to recognise a fault code

When a fault has occurred, the DishDrawer® will continuously beep every second.

The fault code will be displayed on the wash programme selector.

Each fault code is shown in the following chart.

How to attend to a fault code

- 1 Press the  /  button briefly to stop the beeping.
- 2 Press the  /  button to turn the DishDrawer® off. Wait a few seconds.
- 3 Press the  /  button to turn the DishDrawer® back on.

Has the fault code disappeared? >YES > You can continue to use your DishDrawer®.











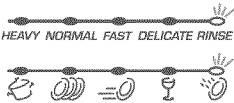
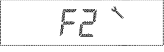
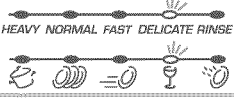

NO

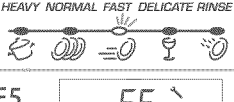

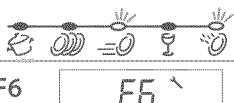

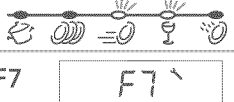

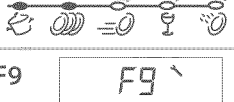
- 4 Note down the fault code.
- 5 Unplug the DishDrawer® or turn it off at the power supply.
- 6 Check the chart overleaf and try correcting the fault where possible, following the instructions in the 'What to do' column.

Has the fault code disappeared? >YES > You can continue to use your DishDrawer®.

NO

- 7 Unplug the DishDrawer® or turn it off at the power supply.
- 8 Call your Authorised Service Centre or Customer Care and advise them of the fault code. This information will help them respond to your request.

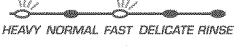
Fault codes	Possible causes	What to do
<p>F1 </p> 	<p>Flood switch has been activated.</p>	<p>Turn off the water supply to the DishDrawer® and call your Authorised Service Centre or Customer Care.</p>
<p>F2 </p> 	<p>Motor problem.</p>	<p>Call your Authorised Service Centre or Customer Care.</p>
<p>F3 </p> 	<p>Temperature sensor failed.</p>	<p>Ensure water coming in through the inlet hose is less than 65 °C. You may need to install a tempering valve on your water supply.</p>
<p>F4 </p> 	<p>Faulty temperature sensor or element.</p>	<p>Call your Authorised Service Centre or Customer Care.</p>
<p>F5 </p> 	<p>Lid fault.</p>	<p>Plug the DishDrawer back in or turn it on at the power supply. Fault may reset.</p>
<p>F6 </p> 	<p>Lid fault.</p>	<p>Plug the DishDrawer back in or turn it on at the power supply. Fault may reset.</p>
<p>F7 </p> 	<p>Lid fault.</p>	<p>Plug the DishDrawer back in or turn it on at the power supply. Fault may reset.</p>
<p>F9 </p> 	<p>Electronics malfunction.</p>	<p>Call your Authorised Service Centre or Customer Care.</p>

Fault codes	Possible causes	What to do
<p>U1 </p>  <p>HEAVY NORMAL FAST DELICATE RINSE</p> 	<p>Fill fault due to...</p> <p>...water supply not being turned on.</p> <p>OR</p> <p>...spray arm not being fitted correctly.</p>	<p>Check if there is water in the DishDrawer and follow the relevant steps below.</p> <p><i>If there is no water in the DishDrawer:</i></p> <ol style="list-style-type: none"> 1 Turn on the water supply to the DishDrawer. 2 Plug the DishDrawer back in or turn it on at the power supply. <p><i>If there is water in the DishDrawer:</i></p> <ol style="list-style-type: none"> 1 Plug the DishDrawer back in or turn it on at the power supply. 2 Press the ► button and wait for 30 seconds. 3 Press the ⏻ / ⏹ button. The DishDrawer will automatically drain (approx. 2 minutes). You may need to repeat steps 2 and 3 again. 4 When the DishDrawer is empty, check that the spray arm is correctly fitted and can rotate freely. See 'User maintenance instructions'.
<p>U4 </p>  <p>HEAVY NORMAL FAST DELICATE RINSE</p> 	<p>Fault in the other drawer preventing the use of this drawer.</p>	<p>Check other drawer, attend to fault code on that drawer.</p>

Before you call for service or assistance ...

Check the things you can do yourself. Refer to the installation instructions and your user guide and check that:

- 1 your product is correctly installed
- 2 you are familiar with its normal operation.

If after checking these points you still need assistance, please refer to the Service & Warranty book for warranty details and your nearest Authorised Service Centre, or contact us through our website listed on the back cover.

Fisher & Paykel Appliances

Model _____ Serial no. _____

Date of purchase _____ Purchaser _____

Dealer _____ Suburb _____

Town _____ Country _____

USA & CANADA				
Heavy	Normal	Fast	Delicate	Rinse
pre-wash	pre-wash 120°F		pre-wash	pre-wash
main wash 150°F	main wash 140°F	main wash 130°F	main wash 120°F	
post-rinse	post-rinse	post-rinse	post-rinse	
final rinse 163°F	final rinse 140°F	final rinse 120°F	final rinse 130°F	
drying phase	drying phase		drying phase	
Heavy ECO	Normal ECO	Fast ECO	Delicate ECO	
pre-wash			pre-wash	
main wash 150°F	main wash 120°F	main wash 115°F	main wash 115°F	
post-rinse	post-rinse	post-rinse	post-rinse	
final rinse 150°F	final rinse 125°F	final rinse 115°F	final rinse 120°F	
drying phase	drying phase		drying phase	

NEW ZEALAND AND AUSTRALIA				
Heavy	Normal	Fast	Delicate	Rinse
				pre-wash
main wash 70°C	main wash 50°C	main wash 55°C	main wash 50°C	
post-rinse	post-rinse	post-rinse	post-rinse	
final rinse 65°C	final rinse 60°C	final rinse 50°C	final rinse 60°C	
drying phase	drying phase		drying phase	
Heavy ECO	Normal ECO*	Fast ECO	Delicate ECO	
main wash 65°C	main wash 40°C	main wash 45°C	main wash 45°C	
post-rinse	post-rinse	post-rinse	post-rinse	
final rinse 60°C	final rinse 40°C	final rinse 45°C	final rinse 50°C	
drying phase	drying phase		drying phase	

*Reference programme for energy label in compliance with AS/NZS 2007.

GREAT BRITAIN AND IRELAND				
Heavy	Normal	Fast	Delicate	Rinse
				pre-wash
main wash 70°C	main wash 65°C	main wash 55°C	main wash 50°C	
post-rinse	post-rinse	post-rinse	post-rinse	
final rinse 65°C	final rinse 65°C	final rinse 50°C	final rinse 60°C	
drying phase	drying phase		drying phase	
Heavy ECO	Normal ECO*	Fast ECO	Delicate ECO	
main wash 60°C	main wash 55°C	main wash 45°C	main wash 45°C	
post-rinse	post-rinse	post-rinse	post-rinse	
final rinse 55°C	final rinse 60°C	final rinse 45°C	final rinse 50°C	
drying phase	drying phase		drying phase	

*Reference programme for energy label in compliance with EN50242 Regulations.

Note:

Wash times can vary depending on the incoming water temperature, ambient conditions, type of dish load and whether the drawer has been opened during the wash. Wash times are only APPROXIMATE on the electronic display and based on 120°F (USA and Canada), 20°C (New Zealand and Australia), or 15°C (Great Britain and Ireland) incoming water.

The DishDrawer®s are tested to various standards for both wash and dry performance using the parameters detailed below.

Wash program	Normal
Detergent quantities	5g (pre-wash) per drawer 10g (main wash) per drawer
Rinse agent setting	4
Maximum place setting (per drawer)	6
Water softener setting (for DD24-H models only)	Adjust the water softener to match the water hardness. Refer to the 'Water softener' and 'Option adjustments' section.

Height setting of adjustable racks

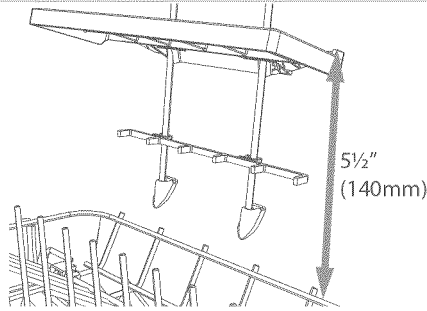

Recommended loading pattern

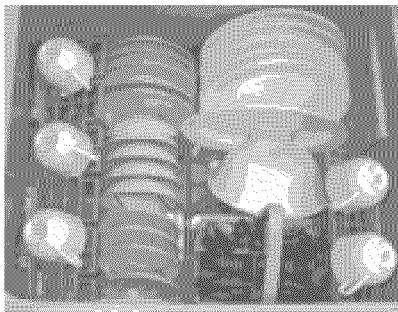

Top drawer

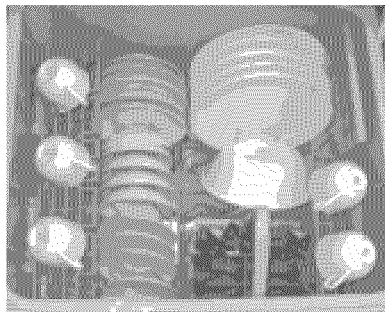

Bottom drawer

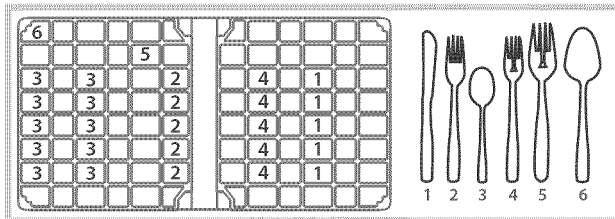

Cutlery basket

The DishDrawer®s are tested to AS/NZS 2007 standards for both wash and dry performance, using the parameters detailed below.

Wash programme	Normal Eco (At the end of the programme, open the DishDrawer 50 mm to improve the dry performance.)
Detergent quantities	22.5g (main wash) per drawer
Rinse aid setting	4
Maximum place setting (per drawer)	6
Accessories to be used in the Dishwasher standards test	Base rack, drain filter access panel, folding tines, 'slide-and-fold' tines, cutlery basket with cutlery grid, adjustable racks, glass supports.

Height setting of adjustable racks

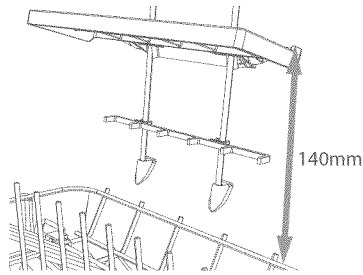

Correct orientation of glass supports on both sides of drawer

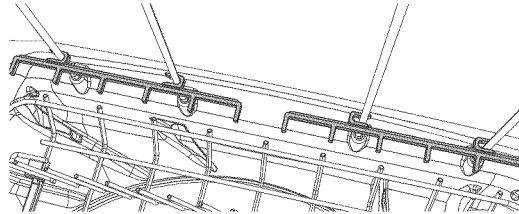

Recommended loading pattern

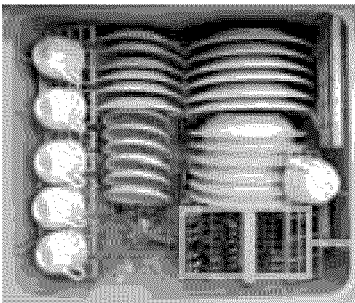

Top and Bottom drawer

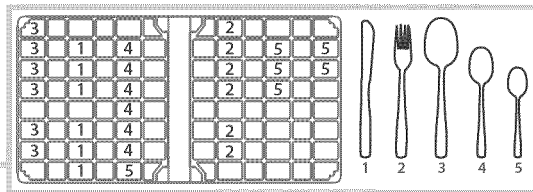

Cutlery basket

42 Standards test - GREAT BRITAIN and IRELAND

The DishDrawer®s are tested to EN50242 standards for both wash and dry performances using the parameters detailed below.

Wash programme	Normal Eco
Detergent quantities	2.5g (pre-wash) per drawer 15.5g (main wash) per drawer
Rinse aid setting	4
Water softener setting	Adjust the water softener to match the water hardness. Refer to the 'Water softener' and 'Option adjustments' sections.
Maximum place setting (per drawer)	6
Accessories to be used in the Dishwasher standards test	Base rack, drain filter access panel, folding tines, 'slide-and-fold' tines, cutlery basket, adjustable racks, glass supports.

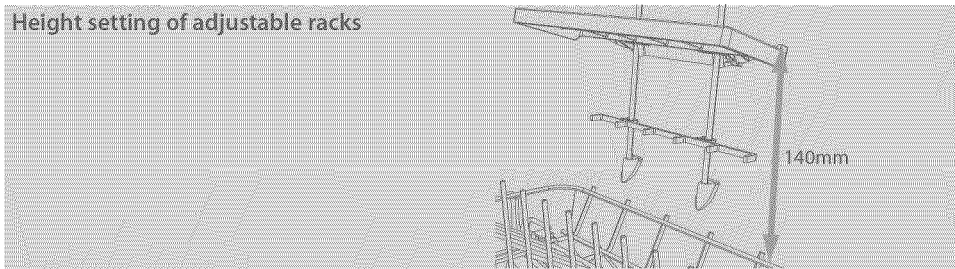

Correct orientation of glass supports on both sides of drawer

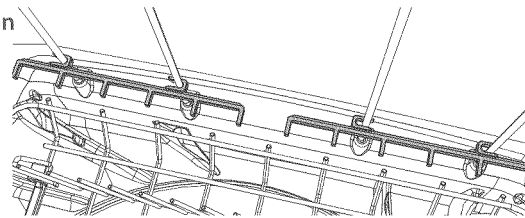

Recommended loading pattern

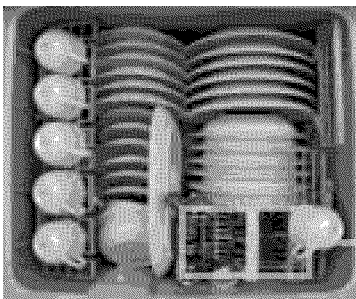

Top and Bottom drawer

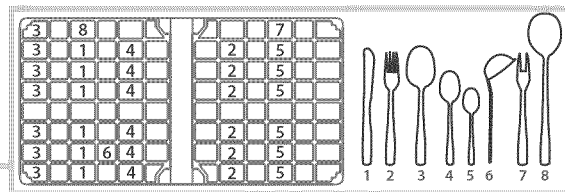

Cutlery basket

www.fisherpaykel.com
www.fisherpaykel.ca
www.fisherpaykel.co.nz
www.fisherpaykel.com.au
www.fisherpaykel.co.uk
www.fisherpaykel.ie

Fisher & Paykel

Copyright © Fisher & Paykel 2010. All rights reserved.

The product specifications in this booklet apply to the specific products and models described at the date of issue. Under our policy of continuous product improvement, these specifications may change at any time. You should therefore check with your Dealer to ensure this booklet correctly describes the product currently available.

US CA NZ AU GB IE

F&P PN - 590030 A

04.2010