

This Owner's Manual is provided and hosted by [Appliance Factory Parts](#).



FISHER & PAYKEL DD24DCTB6 Owner's Manual

[Shop genuine replacement parts for FISHER & PAYKEL
DD24DCTB6](#)



[Find Your FISHER & PAYKEL Dishwasher Parts - Select From 34 Models](#)

----- Manual continues below -----

User guide

DishDrawer

DD24 models

Guide de l'utilisateur

DishDrawer®

Modèles de série DD24

US CA

Safety and warnings	3
Operating instructions	
Controls (models with no LCD)	6
Controls (models with LCD)	8
Operation	10
Wash program chart	11
Caring for your dinnerware	12
Dishwasher standards test	13
Racking features	14
Loading suggestions	16
Detergent dispenser	18
Water softener	20
Rinse agent dispenser	22
Option adjustments	23
User maintenance instructions	26
Troubleshooting	29
Fault codes	31
Warranty and service	34

Important!

SAVE THESE INSTRUCTIONS

The models shown in this User Guide may not be available in all markets and are subject to change at any time. For current details about model and specification availability in your country, please visit our local website listed on the back cover or contact your local Fisher & Paykel dealer.

Your DishDrawer has been carefully designed to operate safely during normal dishwashing procedures. Please keep the following instructions in mind when you are using your DishDrawer®.

Important safety instructions

WARNING! - When using your dishwasher, follow basic precautions, including the following:

- *Read all instructions before using the DishDrawer®.*
- *The information in this manual must be followed to minimize the risk of fire or explosion or to prevent property damage, personal injury or loss of life.*
- *Use the DishDrawer® only for its intended function as described in this user guide.*
- *Use only detergents or rinse agent recommended for use in a domestic dishwasher and keep them out of reach of children. Check that the detergent dispenser is empty after the completion of each wash program.*
- *When loading items to be washed, locate sharp items so that they are not likely to damage the lid seal and load sharp knives with the handle up to reduce the risk of cut-type injuries.*
- *Do not touch the heater plate during or immediately after use.*
- *Do not operate your DishDrawer® unless all enclosure panels are properly in place.*
- *Do not tamper with the controls.*
- *Do not abuse, sit on, stand in or on the drawer or dish rack of the DishDrawer®.*
- *The adjustable racks are designed to support cups, glasses and kitchen utensils. When the adjustable racks are in the DishDrawer® do not lean on or use them to support your body weight.*
- *To reduce the risk of injury, do not allow children to play in or on the DishDrawer®.*
- *Under certain conditions, hydrogen gas may be produced in a hot water heater system that has not been used for two weeks or more. HYDROGEN GAS IS EXPLOSIVE. If the hot water system has not been used for such a period, before using the dishwasher, turn on all hot water faucets and let the water flow from each for several minutes. This will release any accumulated hydrogen gas. As the gas is flammable, do not smoke or use an open flame during this time.*
- *Remove the door to the washing compartment when removing an old dishwasher from service or discarding it.*
- *Dishwasher detergents are alkaline. They can be dangerous if swallowed. Avoid contact with skin and eyes, keep children and infirm persons away from the dishwasher when the drawer is opened.*

Important safety instructions

Installation

- *This DishDrawer® must be installed and located in accordance with the Installation instructions before it is used. If you did not receive Installation instruction sheets with your DishDrawer®, you can order them by calling your Authorized Service Agent or from the Fisher & Paykel website, www.fisherpaykel.com.*
- *Installation and service must be performed by a qualified technician.*
- *If the power supply cord is damaged, it must be replaced by a dealer or Authorized Service Center or a similar qualified trades person in order to avoid a hazard.*
- *Ensure the DishDrawer® is secured to adjacent cabinetry using the brackets provided. Failure to do so may result in an unstable product, which may cause damage or injury.*
- *Do not operate this appliance if it is damaged, malfunctioning, partially disassembled or has missing or broken parts, including a damaged power supply cord or plug.*
- *Do not store or use petrol, or other flammable vapors and liquids in the vicinity of the DishDrawer®.*
- *Connect to a properly rated, protected and sized power supply circuit to avoid electrical overload.*
- *Make sure that the power supply cord is located so that it will not be stepped on, tripped over or otherwise subject to damage or stress.*
- *Do not install or store the DishDrawer® where it will be exposed to temperatures below freezing or exposed to weather.*
- *Do not use an extension cord or a portable electrical outlet device (e.g. multi-socket outlet box) to connect the DishDrawer® to the power supply.*
- *This appliance must be grounded. In the event of a malfunction or breakdown, grounding will reduce the risk of electric shock by providing a path of least resistance for electric current. This appliance is equipped with a cord having an equipment-grounding conductor and a grounding plug. The plug must be plugged into an appropriate outlet that is installed and grounded in accordance with all local codes and ordinances. **WARNING** - Improper connection of the equipment-grounding conductor can result in a risk of electric shock. Check with a qualified electrician or service representative if you are in doubt as to whether the appliance is properly grounded. Do not modify the plug provided with the appliance; if it will not fit the outlet, have a proper outlet installed by a qualified technician.*
- *If the DishDrawer® is installed as a permanently connected appliance:
GROUNDING INSTRUCTIONS - This appliance must be connected to a grounded metal, permanent wiring system, or an equipment-grounding conductor must be run with the circuit conductors and connected to the equipment-grounding terminal or lead on the appliance.*

Important safety instructions

Maintenance

- Do not repair or replace any part of the appliance or attempt any servicing unless specifically recommended in this user guide. We recommend that you call an Authorized Service Agent.
- Keep the floor around your appliance clean and dry to reduce the possibility of slipping.
- Keep the area around/underneath your appliance free from the accumulation of combustible materials, such as lint, paper, rags and chemicals.
- When cleaning the underside of the filter plate, care must be taken on the sharp outer edge to avoid the risk of cut type injuries.

Important!



Under no circumstances should you open the drawer whilst the DishDrawer® is in operation.

Operational

- Always press the ►|| button to pause and wait until you hear the three additional beeps before opening the drawer.
- The DishDrawer® must be used with the motor assembly, filter plate, drain filter and spray arm in place.
- When disconnecting the appliance pull the plug rather than the power supply cord or junction of cord to avoid damage.
- Take care when loading the DishDrawer® not to load dishware items so they prevent the lid from properly sealing with the drawer. Items should be placed so they do not protrude above and/or forced into the drawer, otherwise a service call may result.
- Household appliances are not intended to be played with by children. Children or persons with a disability which limits their ability to use the appliance, should have a responsible person instruct them in its use. The instructor should be satisfied that they can then use the appliance without danger to themselves or their surroundings.
- Close supervision is necessary if this appliance is used by or near children. Do not allow children to play inside, on or with this appliance or any discarded appliance.
- If a dishwasher cleaner is used, we would strongly recommend a wash program with detergent should be run immediately afterward, to prevent any damage to the DishDrawer®.
- The DishDrawer® is designed for washing normal household utensils. Items that are contaminated by petrol, paint, steel or iron debris, corrosive, acidic or alkaline chemicals are not to be washed in the DishDrawer®.
- If the DishDrawer® is not being used for long periods of time, turn the electricity and water supply to the DishDrawer® off.
- Do not pour detergent or rinse agent into the salt reservoir. The detergent or rinse agent will destroy the water softener.



If you have a double DishDrawer®, each drawer has its own controls and can run independently of the other.

Power button

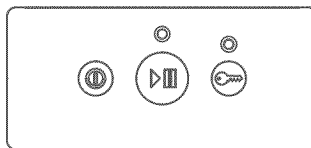
The  button turns the DishDrawer® on or off. Opening the drawer will automatically turn the DishDrawer® on for 30 seconds. To end a wash program in mid cycle, press the  button. Any water in the DishDrawer® will be pumped out.



Start/Pause button





The  button starts a wash program. Press the  button to pause or restart the DishDrawer® during a wash program. When paused, wait for three beeps before opening the drawer. Forcing the drawer open while in mid cycle may cause damage or injury.



Delay start

The  button also sets the Delay start feature which can delay the start of a wash program from 1 to 12 hours.

To activate Delay start

- 1 Press and hold the  button until the light above the  button turns orange (or purple, depending on your model).
- 2 Continue holding the  button down until the desired delay time has been reached. The DishDrawer® will emit audible 'beeps' as you hold the  button down, each beep indicates another hour delay.
- 3 The DishDrawer® will start once the delay time has elapsed and the drawer is closed.

To cancel Delay start

Press the  button.



Lock button (optional)



The  button activates/deactivates the Keylock or the Childlock functions.



Keylock



The Keylock feature disables all the buttons on the DishDrawer®.



To activate, press and hold the  button until you hear one beep (3 seconds). The light above the  button is lit when Keylock is activated.

To cancel the Keylock feature, press and hold the  button until the light above the  button disappears.

Childlock

The Childlock feature locks the drawer and disables all the buttons.

To activate, press and hold the  button until you hear two beeps (5 seconds). The light above the  button is lit when Childlock is activated.

To cancel the Childlock feature, press and hold the  button until the light above the  button disappears.

Wash program selector

Press the  button to select a wash program. The DishDrawer® will remember the last program used.



Eco button *ECO* (optional)

Press the *ECO* button if you would like the wash program to use less energy. The red ECO light will indicate the feature is on. If your dishes are heavily soiled or you require enhanced dry performance, we do not recommend ECO programmes.



Power failure

If the DishDrawer® is operating and a power failure occurs, it will stop. The DishDrawer® may be unable to be opened during this time. When the power supply is resumed, the DishDrawer® will restart in the same part of the wash program.

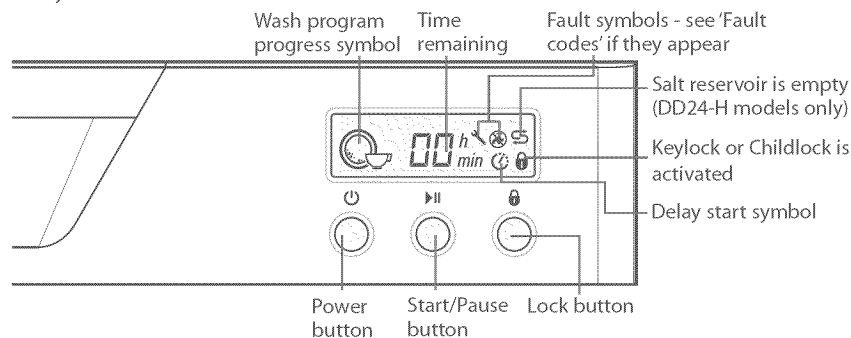

If you have a double DishDrawer®, each drawer has its own control panel and can run independently of the other.



Power button

The  button turns the DishDrawer® on or off. Opening the drawer will automatically turn the DishDrawer® on for 30 seconds. To end a wash program in mid cycle, press the  button. Any water in the DishDrawer® will be pumped out.



Start/Pause button

The  button starts a wash program. Press the  button to pause or restart the DishDrawer® during a wash program. When paused, wait for three beeps before opening the drawer. Forcing the drawer open while in mid cycle may cause damage or injury.

Delay start

The  button also sets the Delay start feature which can delay the start of a wash program from 1 to 12 hours.

To activate Delay start

- 1 Press and hold the  button until the delay symbol  appears on the electronic display.
- 2 Continue holding the  button down until the desired delay time has been reached.
- 3 The DishDrawer® will start once the delay time has elapsed and the drawer is closed.

To cancel Delay start



Press the  button.

Lock button (optional)

The  button activates/deactivates the Keylock or the Childlock functions.



Keylock



The Keylock feature disables all the buttons on the control panel.

To activate, press and hold the  button until you hear one beep (3 seconds). The  symbol appears in the electronic display when the Keylock feature is activated.

Childlock

The Childlock feature locks the drawer and disables all the buttons on the control panel.

To activate, press and hold the  button until you hear two beeps (5 seconds). The  symbol appears in the electronic display when the Childlock feature is activated.

To cancel the Childlock feature, press and hold the  button until you hear one beep and the  symbol disappears from the electronic display.

Wash program selector

Press the  button to select a wash program. The DishDrawer® will remember the last program used.

**Eco button *ECO* (optional)**

Press the *ECO* button if you would like the wash program to use less energy. The red ECO light will indicate the feature is on. If your dishes are heavily soiled or you require enhanced dry performance, we do not recommend ECO programmes.

Wash program progress symbols

As the wash program advances through the cycle, the following symbols will appear in the electronic display to indicate the progression. When a wash program has started, the electronic display also will count down the time remaining in one minute increments.

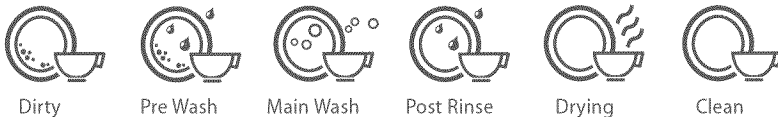
**Power failure**

If the DishDrawer® is operating and a power failure occurs, it will stop. The DishDrawer® may be unable to be opened during this time. When the power supply is resumed, the DishDrawer® will restart in the same part of the wash program.

1 Load dishes

Remove all food scraps and load the dishes.

2 Add detergent**3 Check rinse agent****4 Press the  button****5 Select a wash program**

The length of the wash program will appear on the electronic display (models with LCD only).

6 Select *ECO* (optional)**7 Check**

Ensure there is nothing obstructing the spray arm. The drain filter must be level with the filter plate.

8 Start

Close the drawer and press the  button.

9 Finish

The DishDrawer® will beep six times to indicate the end of the wash program. At the end of the wash program the drying fan will continue to run for a set time or until the drawer is opened. The fan assists with drying and uses negligible amounts of energy. It is normal for some water to remain in the drain filter area after the wash program is complete.

Double models only: At the end of a wash program, you may find both drawers draining simultaneously. This is normal.

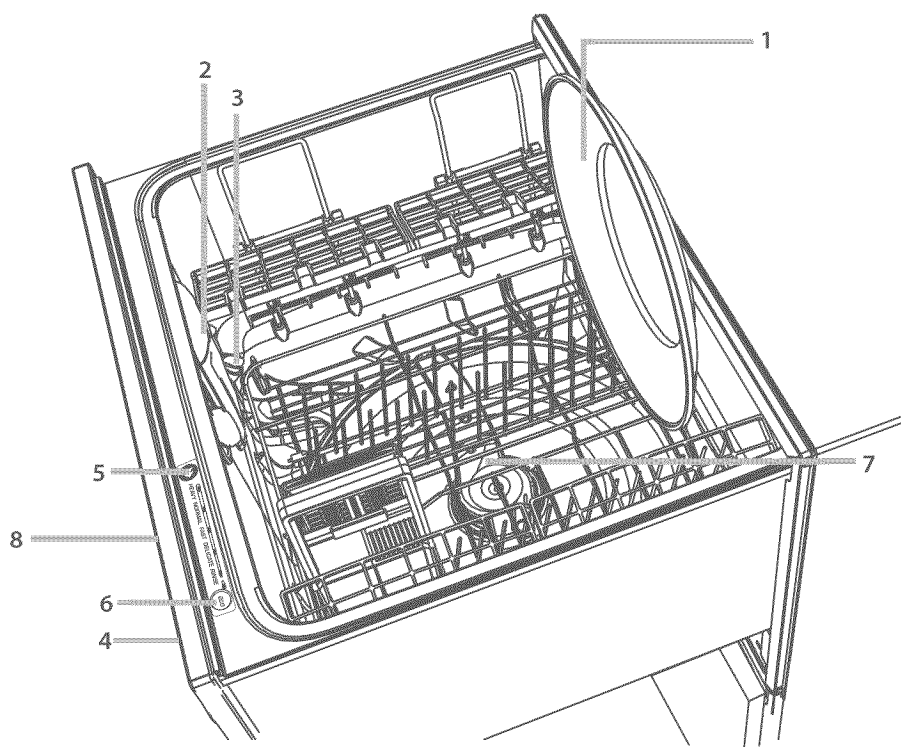

Standard wash program - when to use

Heavy <i>Heavily soiled pots, pans and dishes.</i>	Normal <i>Dishes with normal soils for optimum wash and dry performance.</i>	Fast <i>Lightly soiled dishes.</i>	Delicate <i>Lightly soiled and heat sensitive crockery.</i>	Rinse <i>Prevents odors and soils drying on dishes.</i>
pre-wash 1	pre-wash 1		pre-wash	pre-wash
pre-wash 2	pre-wash 2			
main wash 150°F	main wash 140°F	main wash 130°F	main wash 120°F	
post-rinse 1	post-rinse	post-rinse	post-rinse	
post-rinse 2				
final rinse 163°F	final rinse 140°F	final rinse 120°F	final rinse 130°F	
drying phase	drying phase		drying phase	

Eco wash program - when to use

Heavy <i>Heavily soiled everyday dishes.</i>	Normal <i>Normal soiled dishes for optimum energy use.</i>	Fast <i>Lightly soiled, non greasy dishes.</i>	Delicate <i>Lightly soiled, non greasy and heat sensitive crockery.</i>
pre-wash 1	pre-wash		pre-wash
pre-wash 2			
main wash 150°F	main wash 130°F	main wash 115°F	main wash 115°F
post-rinse 1	post-rinse	post-rinse	post-rinse
post-rinse 2			
final rinse 150°F	final rinse 130°F	final rinse 115°F	final rinse 120°F
drying phase	drying phase		drying phase

Note:

Wash times can vary depending on the incoming water temperature, ambient conditions, type of dish load and whether the drawer has been opened during the wash. Wash times are only APPROXIMATE on the electronic display and based on 120°F incoming water.

Caring for your dinnerware

The combination of high temperatures and dishwasher detergent may cause damage to some items if they are washed in the DishDrawer®. Remember, if in any doubt about any aspect concerning items washed in the DishDrawer®, follow the instructions from the manufacturer of the items, or wash the item by hand.

Cutlery & silverware

All cutlery and silverware should be rinsed immediately after use to prevent tarnishing caused by some foods. The Rinse wash program is useful for this. Silver items should not come into contact with stainless steel, eg other cutlery. Mixing these items can cause staining. Remove silver cutlery from the DishDrawer® and hand dry it immediately after the program has finished.

Aluminum

Aluminum can be dulled by dishwasher detergent. The degree of change depends on the quality of the product.

Other metals

Iron and cast iron objects can rust and stain other items. Copper, pewter and brass tend to stain.

Woodware

Wooden items are generally sensitive to heat and water. Regular use in the dishwasher may cause deterioration over time. If in doubt, wash by hand.

Glassware

Most everyday glassware is dishwasher safe. Crystal, very fine and antique glassware may etch that is, become opaque. You may prefer to wash these items by hand.

Plastic

Some plastic may change shape or color with hot water. Check manufacturer's instructions about washing plastic items. Washable plastic items should be weighed down so they do not flip over and fill with water or fall through the base rack during the wash.

Decorated items

Most modern china patterns are dishwasher safe. Antique items, those with a pattern painted over the glaze, gold rims or hand painted china may be more sensitive to machine washing. If in doubt, wash by hand.

Glued items

Certain adhesives are softened or dissolved in machine washing. If in doubt, wash by hand.

Vacation time

If the DishDrawer® is not going to be used for some time, we recommend you leave the DishDrawer® clean and empty. Leave the drawers ajar to allow air to circulate. Turn off both the power and water supply to the DishDrawer®.

The DishDrawer®s are tested to various standards for both wash and dry performance. The following are loading pattern diagrams, detergent quantities and rinse agent quantities used for the DishDrawer®.

Wash program	Normal
Detergent quantities	5g (pre-wash) per drawer 10g (main wash) per drawer
Rinse agent setting	4
Water softener setting (for DD24-H models only)	Adjust the water softener to match the water hardness. Refer to the 'Water softener' and 'Option adjustment' section.

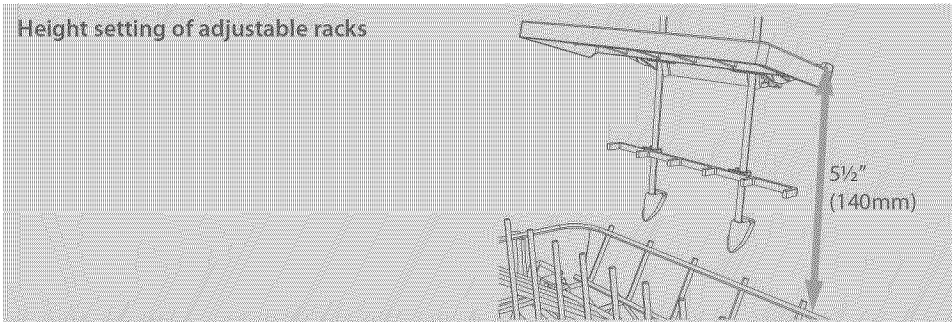

Recommended loading pattern

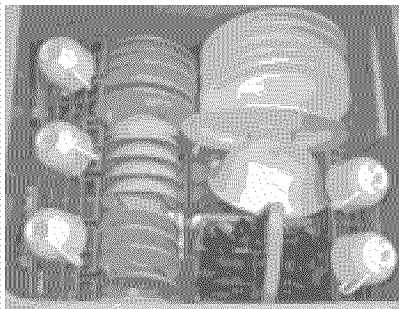

Top drawer

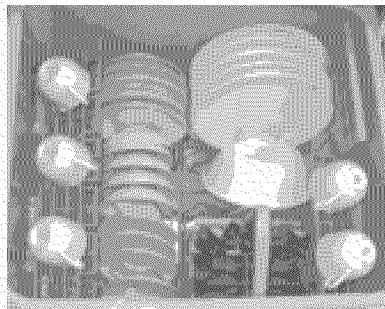

Bottom drawer

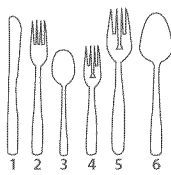
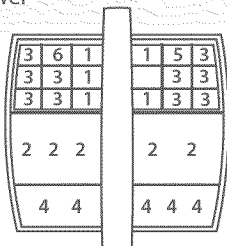

Cutlery basket

- Mix spoons, knives and forks within each section to stop cutlery nesting together.
- Most cutlery is placed with the handle pointing down.
- For your safety, knives and sharp utensils should have their handles up.
- Small light items like baby bottle teats are best placed under the anti-nesting grids to prevent them from being displaced.

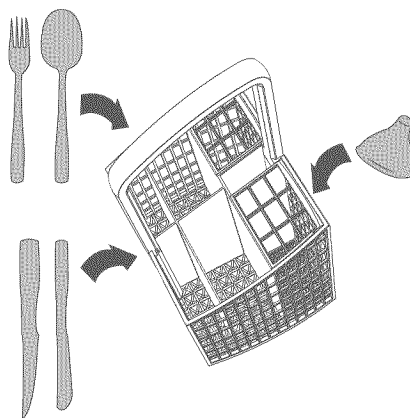

Stemware notches

- The six notches on the left-hand side help support long-stemmed glassware.

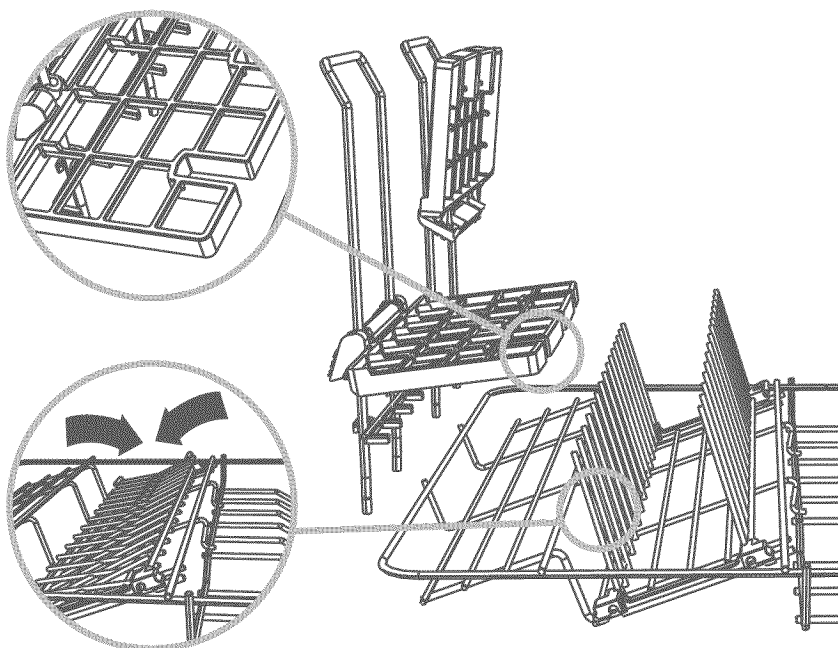

Folding tines

- The front half is ideal for large, deep bowls.
- Fold the tine sections down towards each other if you need the space for pots or other large items.
- Fold down the right-hand section only and lean cups against the upright tines for extra stability.

Adjustable racks

- You can adjust these independently of each other to any height:
 - 1 Fold up to unlock the rack.
 - 2 Adjust the height to suit by sliding up or down.
 - 3 Fold down to lock in position.
- Fold the racks away if you need the space.

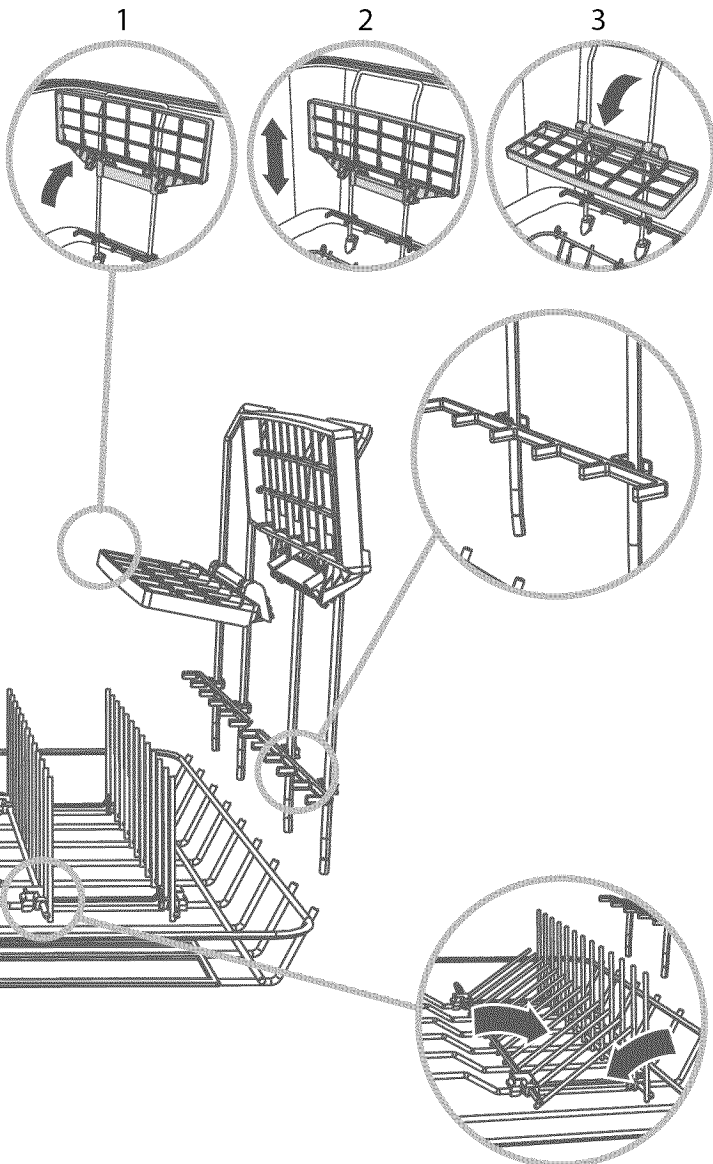

Glass supports

- These clip on the rack wires to give your tall glasses extra stability.

'Slide-and-fold' tines

- Slide all the way to the left to fit larger dinner plates.
- Fold the tine sections down towards each other if you need the space for pots or other large items.

When loading your DishDrawer, make sure that

- you place items so that water coming from the rotating spray arm below can reach all areas (performance will be reduced if it can't)
- nothing blocks the water from getting to items on the adjustable racks
- you place bowls and pots with their openings facing down
- plates do not nest together.

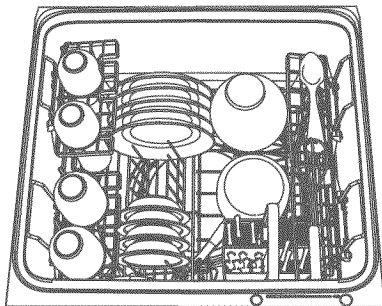
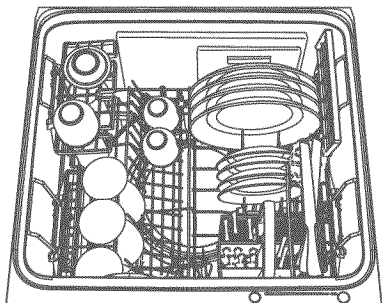
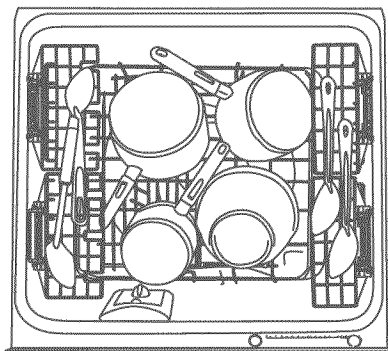
Typical breakfast load**Typical dinner party load****Typical heavy load**

How NOT to load your DishDrawer®

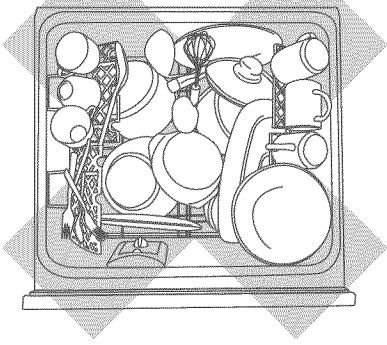

- Overcrowded and wash water will not reach some of the dinnerware.
- Cups, glasses and bowls must have their openings facing down.

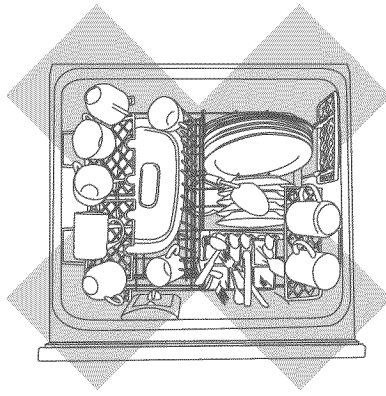

- The plates are nesting together and wash water may not get through.
- Ensure cutlery are not nesting or stuck together. They need to be evenly spread out.

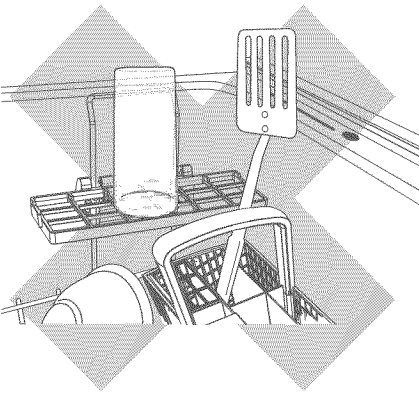

- Ensure dishware items are not forced into or protrude out of the drawer as it may prevent the lid from properly sealing which could result in a service call.
- Locate sharp items safely to prevent injuring the user and damaging the lid assembly.
- Check the bottom of the cutlery basket to ensure sharp or pointed items have not come through as they may stop spray arm rotation.

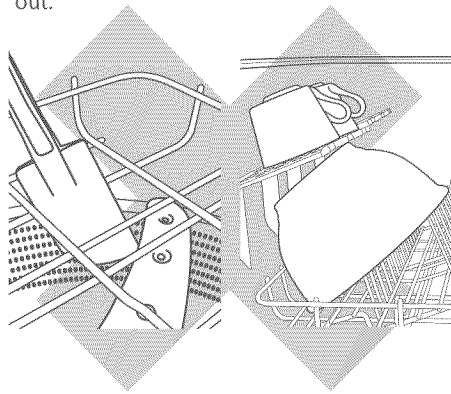

- Ensure cutlery has not fallen through the base rack and stopped the spray arm from rotating.
- The large bowl is blocking wash water reaching the adjustable racks.
- Large utensils should be on the adjustable racks so they do not become dislodged and stop the spray arm from rotating.
- Sharp or pointed items must be placed horizontally or with sharp edges/points facing down to avoid risk of injury.

Important!

- Only use powdered detergent recommended for domestic automatic dishwashers in the detergent dispenser.
- Dishwasher detergents are strongly alkaline and can be dangerous if swallowed.
- Avoid contact with skin and eyes.
- Keep children and infirm persons away from the DishDrawer® when the drawer is open.
- Check that the detergent receptacle is empty after completion of the wash cycle.
- We do not recommend using dishwasher tablets in the DishDrawer®.
- Do not place dishwasher tablets in the detergent dispenser.
- Detergent and dishwasher tablets should not be in direct contact with dishes or cutlery.
- Liquid detergents are not suitable to be used in the DishDrawer®.
- Hand washing liquids, soap, laundry detergents or disinfectants will damage the DishDrawer®.

Filling the detergent dispenser

- 1 Press the latch down and the door will open.
- 2 Pour in detergent. No detergent is needed for the Rinse program.
- 3 After filling the main wash compartment, close the dispenser door until it clicks shut. The detergent will automatically be released into the DishDrawer® during the wash program.

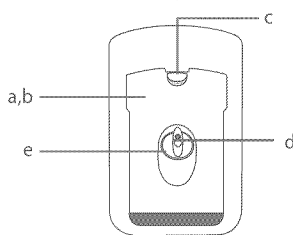

Closed detergent dispenser

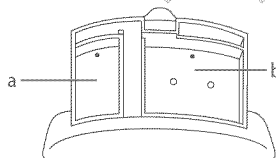
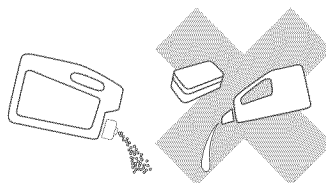

Open detergent dispenser

- a Pre-wash compartment, 10g / 2 teaspoon capacity
- b Main wash compartment, 30g / 6 teaspoon capacity
- c Detergent dispenser latch
- d Rinse agent indicator light
- e Rinse agent plug



Detergent quantities

The detergent quantities recommended below are for individual drawers.

Water type parts per million (ppm) grains per gallon (gpg)	Wash program	Detergent quantities	
		prewash (teaspoons)	main wash (teaspoons)
Hard (>150ppm or >9gpg)	All*	2	6
Medium (100-150ppm or 6-9gpg)	All*	2	4
Soft (<100ppm or <6gpg)	Heavy	1	3
	Normal	1	2
	Delicate		1
	Fast		1

* No detergent is required in the pre wash compartment for the Fast wash program.

Hard water situations

If you live in a hard water situation, we recommend the installation of a household water softener to improve the water quality, detergent effectiveness and prevent the build-up of calcium deposits on dishes and in the DishDrawer®.

Certain brands of dishwasher detergent contain varying quantities of phosphates, which help soften water. We suggest you use a detergent with high phosphate content to improve the wash. The detergent compartments need to be completely FULL and rinse agent is used with its setting fixed at 5.

We recommend the use of a dishwasher cleaner/descaler whenever you notice a build-up of calcium deposits in your DishDrawer®.

After you have used the dishwasher cleaner/descaler you must run another wash program with detergent to prevent damage to the DishDrawer®.

Soft water situations

If you live in an area of naturally soft water or your household water is softened, avoid using too much detergent in your DishDrawer®. An excess amount of detergent is very aggressive on glassware and may cause irreversible etching.

Etching is a chemical deterioration that occurs on the surface of glassware when it is subjected to high temperatures, too much detergent and/or soft water situations. Etching is caused by a combination of very hot water, which causes the detergent to become very aggressive, but because the water is soft, there are no water hardness mineral ions for the detergent to bind to, so it extracts mineral ions directly from the glass.

Etching looks like rainbow-colored film, as the glass is subjected to further washing the surface will eventually appear opaque. This type of etching is irreversible.

To prevent further etching from occurring on glassware, use less detergent (follow the recommended detergent quantities in the user guide for soft water situations), and ensure the DishDrawer® is not overloaded, so water can reach all the dishes during the wash.

Setting up the water softener

Using hard water (above 100ppm) for dishwashing can be detrimental to the performance of your DishDrawer®. Glasses will become opaque and dishes will become spotted or covered in a white film.

Determine the water hardness in your local area

Your local water company will be able to provide you with information. Identify the setting you require for your DishDrawer® from the water hardness table below. For example, if your water hardness is 500ppm, then the water softener setting on your DishDrawer® should be four. Refer to the 'Option adjustments' section to adjust the water softener so that the setting corresponds to your water hardness.

DishDrawer® setting	Grains per Gallon (gpg)	Parts per Million (ppm)
0	0-6	0-100
1	6-14	100-250
2	14-20	250-350
3	20-26	350-450
4	26-32	450-550
5	32-36	550-625

Note:

- If your water hardness is above 625ppm, we highly recommend you completely fill the detergent compartment for all programs except Rinse and the rinse agent setting be at 5. If your water hardness is above 625ppm, the wash performance of your DishDrawer® will decline.
- You may hear some unusual noises when the water softener is in operation, this is normal.

How to fill the salt reservoir

- 1 Open the DishDrawer®.
- 2 Unscrew the salt reservoir cap by turning counter-clockwise.
- 3 Place the salt into the salt container and pour the contents into the salt reservoir. The salt reservoir can hold just over one pound/0.5 kg of salt.
- 4 Fit the cap tightly back into its original position.
- 5 If you do not wash your dishes immediately after filling the salt reservoir, run a Rinse program to remove any salt water or spilt granules.

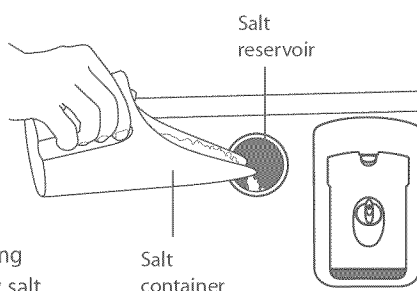

Note:

When filling the salt reservoir, you may notice water being displaced from the water softener overflow.

Important!

The water softener must always be filled with granular salt made especially for dishwasher water softening systems. We do not recommend the use of cooking salt like table salt, rock salt or pellets as they may contain impurities that will impair or diminish the life of the water softener.

The salt reservoir

Water softening can only take place when there is salt in the reservoir. The salt reservoir must be filled prior to using the DishDrawer® and whenever the salt reservoir indicator light is red.

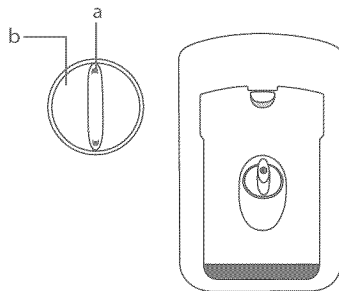

a Salt indicator light
b Salt reservoir cap

Salt indicator light

- If the salt indicator light is red, the salt reservoir is empty.
- If the salt indicator light is black, there is enough salt in the reservoir for the wash program that has been selected.
- Models with LCD only: The electronic display will also indicate when the salt reservoir is empty by displaying the salt **S** symbol.

Important!

Do not pour detergent or rinse agent into the salt reservoir. Detergent and rinse agent will destroy the water softener.



Salt only

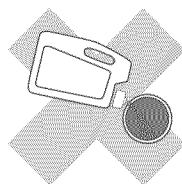

NO Detergent

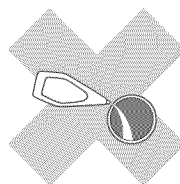

NO Rinse Agent

Rinse agent dispenser

We highly recommend the regular use of liquid rinse agent to give the best drying results. Rinse agent gives a streak-free, sparkling clean look to glass and chinaware. In addition, it prevents metal from tarnishing. The rinse agent dispenser is on the inside of the drawer, located underneath the detergent dispenser. The rinse agent dispenser holds approximately 1.7fl oz (50 ml) of rinse agent.

Filling the rinse agent dispenser

- 1 Turn the plug counter-clockwise and remove.
- 2 Pour the rinse agent into the circular opening.
- 3 Take care not to spill rinse agent into the DishDrawer®. Any spillages must be wiped up to prevent excess foaming. Failure to wipe rinse agent spillages may result in a service call which will not be covered by warranty.
- 4 Fit the plug back into the original position.

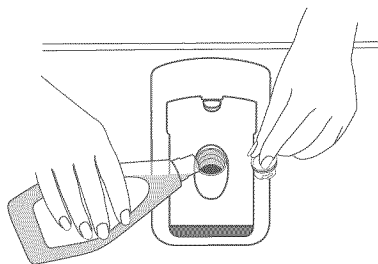

How much rinse agent to use

The regulator may need adjusting to suit your water conditions. The lowest setting is '1' and the highest is '5'. Refer to the 'Option adjustments' section to adjust the rinse agent setting. If there is excessive foam at the end of the wash, reduce the setting. If dishes are wet or streaky after drying, increase the setting.

Rinse agent indicator light

If the rinse agent indicator light is red, refill the dispenser. If the rinse agent indicator light is dimly lit or not lit at all, there is enough rinse agent for the wash.

Note:

- Lighter colored rinse agents will not dim the indicator light as effectively as darker colored rinse agents.
- When the rinse agent is being dispensed, you may notice some unusual noises during the wash: this is normal.



The following options can be adjusted to suit your preferences:

Rinse agent setting

Reduce the Rinse agent setting if there is excess foam after a wash program.
Increase the Rinse agent setting if dishes are wet or streaky after a wash program.

Water softener setting (DD24-H models only)

Refer to the 'Water softener' section.

Auto power setting

By default, DishDrawer® will automatically turn on whenever the drawer is opened. Washing will not start until the drawer is closed and the ►|| button has been pressed. If you do not want the DishDrawer® to turn on automatically, this feature can be turned off.

End of wash program beeps

By default, DishDrawer® will beep six times at the end of a wash program. This feature can be turned off.

Closed drawer option

The Closed drawer option will lock the DishDrawer® when the drawer is closed. When you wish to open the drawer, press the ⏻ button. When the drawer is fully closed again, the lid will automatically come down after 30 seconds and lock.

If the Keylock feature is used in conjunction with the Closed drawer option, pressing the ⏻ button will not unlock the drawer. The Keylock feature must be turned off to enable DishDrawer® to be opened.

Note: this option is highly recommended if the DishDrawer is to be used in motor homes.















Clean dish indicator option (models with LCD only)

By default, DishDrawer® is programmed with the Clean dish indicator option off. When the Clean dish indicator option is on, the ☐☐ symbol will remain in the electronic display after a wash program has finished to indicate the dishes are clean. When you have unloaded all the dishes, press the ⏻ button to return to normal operating mode.

This option might be useful when dishes have been left in DishDrawer® and you cannot remember if they have been washed or in situations where household members regularly remove only a few clean dishes without emptying the drawer.

We do not recommend the Clean dish indicator option be used in conjunction with the Closed drawer option.

How to make option adjustments (Integrated and Prefinished - no LCD)

Follow the steps below	Rinse agent setting	Water softener setting ¹	Auto power option	End of wash program beeps option	Closed drawer option ²
First	Enter Option adjustment mode: 1 Press the  button to turn power on. Open DishDrawer. 2 Press and hold the ECO and  buttons for 5 seconds until one long beep sounds.				
Press the  button to scroll through options	Prefinished - no LCD red / off Integrated - no LCD red / off 	blue / off green / off 	purple / on orange / on 	blue / on green / on 	red / on red / on 
Make an adjustment	The current setting is shown on the wash program selector in red lights. If four red lights are lit, the option selected setting is set to four. Press the  button to increase the setting.				
Save	Press the  button to save the change.				
Example	 Rinse agent setting set to four	 Water softener setting set to four	 On	 On	 Off

¹ Non-water softener models - the water softener setting does not appear in the sequence of options.

² The option sequence will start again from the Rinse agent setting.

How to make option adjustments (models with LCD)

Follow the steps below	Rinse agent setting	Water softener setting ¹	Auto power option	End of wash program beeps option	Closed drawer option	Clean dish ²
<p>First</p> <p>Enter Option adjustment mode:</p> <ol style="list-style-type: none"> 1 Press the U button to turn power on. Open the DishDrawer. 2 Press and hold the ECO and U buttons for 5 seconds until one long beep sounds. 						
<p>Press the ▶ button to scroll through options</p>						
<p>Make an adjustment</p> <p>The current setting is shown on the wash program selector in red lights. If four red lights are lit, the option selected setting is set to four. Press the U button to increase the setting.</p>	Press the U button to turn the selected option on or off.					
<p>Save</p> <p>Press the U button to save the change.</p>						
<p>Example</p>	 Rinse agent setting set to four	 Water softener setting set to four	 On Off	 On Off	 On Off	 On Off

¹ Non-water softener models - the water softener setting does not appear in the sequence of options.

² The option sequence will start again from the Rinse agent setting.

Cleaning the surfaces

Important!

We do not recommend the use of the following cleaning aids on your DishDrawer® as they may damage the surfaces:

- *Plastic or stainless steel scouring pads*
- *Abrasive, solvent, household cleaners*
- *Acid or alkaline cleaners*
- *Hand washing liquids or soap*
- *Laundry detergents or disinfectants*
- *Proprietary 'Stainless Steel' cleaners or polishes as these may damage the protective coating.*

- 1 Wipe with a clean damp cloth. Take care not to wet the control panel.
- 2 Dry with a clean lint-free cloth.

Cleaning the drain filter, spray arm and filter plate

We recommend that the drain filter is cleaned whenever there is evidence of food particles. The spray arm and filter plate may need cleaning about once a month in normal use or more often should the need arise.

If a dishwasher cleaner/descaler is used, you must run a wash program with detergent immediately afterward to prevent any damage to your DishDrawer®.

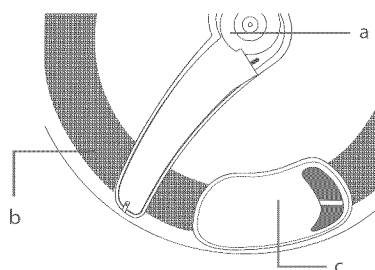

Internal parts of the DishDrawer® :

- a Spray arm
- b Filter plate
- c Drain filter

Important!

The DishDrawer® must be used with the filter plate, drain filter and spray arm correctly in place.

Cleaning the drain filter

- 1 Lift up the drain filter access panel on the base rack (if fitted).
- 2 Lift and remove the drain filter.
- 3 Empty, rinse clean under running water and replace back into the allocated space.
- 4 Ensure the drain filter is flush with the filter plate.

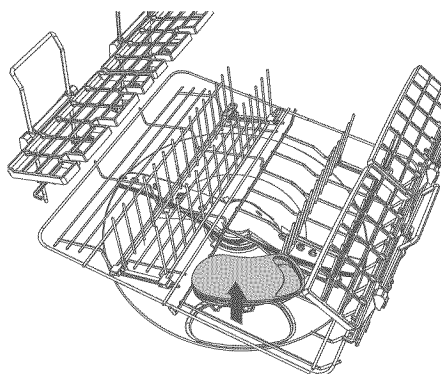
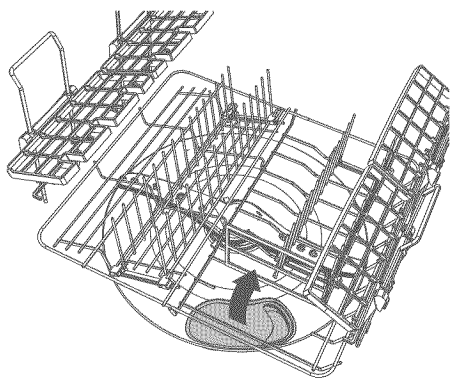

Cleaning the spray arm and filter plate

Ensure the DishDrawer® is cool before you start cleaning and follow the instructions for removing the drain filter and spray arm.

- 1 Unclip the glass supports from the rack wires and fold all the adjustable racks away, so that they are upright and close to the top.
- 2 Remove the base rack carefully. Lift from the back end first to prevent knocking the detergent and rinse agent dispenser.
- 3 Lift the spray arm and shake any foreign material out.

Rinse the spray arm clean under running water and wipe the with a damp cloth.

- 4 In the center of the filter plate there are two rings. Hold the center ring still and turn the outer ring counter-clockwise, about a 1/8 turn. This will release the filter plate.
- 5 Lift the filter plate out.

When cleaning the underside of the filter plate, take care handling the sharp outer edge to avoid the risk of cuts.

Remove any foreign material, wash in hot soapy water and rinse thoroughly in clean water. The heater plate can be wiped with a damp cloth.

- 6 Replace the filter plate so it lies flat in the base of the drawer ensuring the filter plate is fully locked into position with the center ring.

Important!

To lock the filter plate into position, ensure the lines align with each other (c) and all three pin pairs firmly interlock (e). Refer to the diagram for the correct position.

The filter plate must not be able to move about freely.



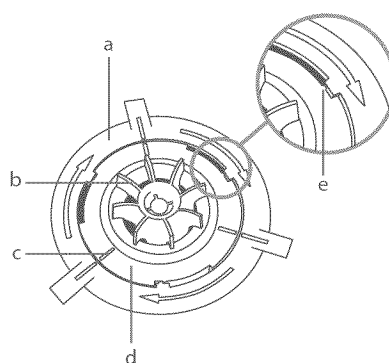
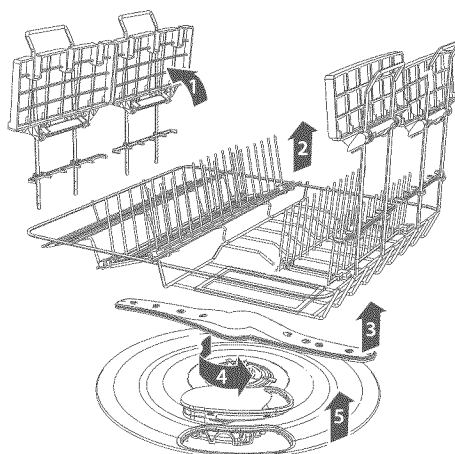

- 7 Replace the spray arm back onto the impeller.
- 8 Replace the base rack, lowering its front edge into position first.

Note: Where there is broken crockery or glass in the drawer, it must be carefully removed to prevent damage to the DishDrawer®.



Correct locking position of filter plate with motor assembly (under spray arm)

- a Outer ring
- b Impeller
- c Correct alignment marks
- d Center ring
- e Interlocking pins

Problem	Possible Cause	What to do
Unclean dishes	Wash program unsuitable for the load.	Refer to the 'Wash program chart' for a suitable wash program, or the soils were too heavily baked on and dishes may need soaking.
	Spray arm unable to rotate.	Ensure no items are obstructing the spray arm path.
	DishDrawer® overloaded/incorrectly loaded.	Refer to the section on loading.
	Filter plate/drain filter is incorrectly inserted.	Refer to the 'User maintenance instructions' section.
	Detergent put in the wrong compartment.	Detergent must be placed in the large compartment.
	Excess food not removed from dinnerware prior to loading.	Scrape all food scraps off dinnerware prior to loading.
	Unsuitable detergent.	Use recommended brands of dishwasher detergent.
	Not enough detergent.	Refer to the detergent section or the detergent manufacturer's instructions.
	Spray arm holes are blocked.	Clean the spray arm.
Foaming	Insufficient salt in the water softener (DD24-H models only).	Ensure there is enough salt in the water softener and/or increase the water softener setting.
	Incorrect amount of detergent.	Refer to the detergent section or consult the detergent manufacturer's instructions.
	Too much egg in the wash load.	Increase the amount of detergent.
Water leaking	Rinse agent setting too high.	Decrease the rinse agent setting.
	Drain hose disconnected from waste pipe.	Reconnect the drain hose to the waste pipe.
	Water inlet hose not properly connected.	Ensure the inlet hose is connected securely.
DishDrawer® will not open	Other leaks.	Turn water and power supplies to the DishDrawer® off. Call your dealer or Authorized Service Agent.
	Childlock feature is on or the Closed drawer option is on, or both.	Turn the Childlock off. Hold down the  button until the  symbol disappears from the LCD screen or the light above the  button disappears and/or press the  button to open the DishDrawer®.
Power failure during cycle.		Wait until power resumes, cycle will restart in same part of wash program.

Problem	Possible Cause	What to do
Continuous beeping	A fault has occurred.	Refer to the 'Fault codes' section.
Intermittent beeping	DishDrawer® is in pause mode.	Close the DishDrawer® and press the ▶ button.
DishDrawer® will not start	Power supply is not connected.	Connect the power supply.
	The drawer is not closed properly.	Ensure the drawer is firmly closed.
	Keylock or Childlock feature is on.	Turn the Keylock or Childlock off. Hold down the 🔒/🔒 button until the 🔒 symbol disappears from the LCD screen or the light above the 🔒/🔒 button disappears.
	▶ button not pressed.	Press the ▶ button.
Excess water in the DishDrawer®	Drain hose(s) bent or kinked.	Straighten the drain hose(s).
	Blocked filters.	Clean the filter plate/drain filter. Refer to the 'User maintenance instructions' section.
Water marks on the dishes	Rinse agent depleted.	Refill the rinse agent dispenser.
	Rinse agent setting too low.	Increase the rinse agent setting.
	DishDrawer® overloaded/incorrectly loaded.	Refer to the section on loading.
	Insufficient or no salt in the water softener (DD24-H models only).	Ensure there is enough salt in the water softener and/or increase the water softener setting.
DishDrawer® interior is stained	Some foods, like tomato based products, may stain the inside of the DishDrawer®.	Pre-rinse dishes before placing in the DishDrawer®. Alternatively, using the Rinse program after adding the dishes may minimize staining.
Dishes did not dry	Incorrect loading.	Ensure the dishes are not nesting together.
	Rinse agent depleted.	Refill the rinse agent dispenser.
	Rinse agent setting too low.	Increase the rinse agent setting.
	Eco wash program used.	Choose a standard wash program.
No detergent dispensed	Detergent dispenser was wet when loaded.	Clean the dispenser and ensure the dispenser is dry when adding detergent.
Excessive motor noise	The filter plate and/or spray arm is incorrectly placed.	Refer to the 'User maintenance instructions' section for details on correct placement.
	No water in the motor area.	This usually occurs on the first use or when the DishDrawer® has not been used for long periods of time. Run the DishDrawer® through a wash program.





How to recognize a fault code













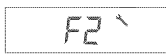
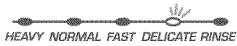

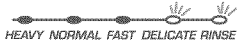

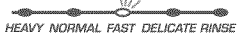
When a fault has occurred, the DishDrawer® will continuously beep every second.

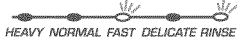

The fault code will be displayed on the electronic display for models with LCD and on the wash program selector for models with no LCD.

Each fault code is shown in the following chart.

How to attend to a fault code

- 1 Press the  button to remove the fault code.
- 2 If the fault code and continuous beeps cannot be removed by pressing the  button, turn the DishDrawer® off at the power supply.
- 3 We recommend you check the following chart and correct the fault where possible.
- 4 After attending to the fault, turn the DishDrawer® on at the power supply.
- 5 If the fault code and continuous beeps remain, turn the water and power supply off to the DishDrawer®.
- 6 When calling your Authorized Service Center, advise them of the fault code that has appeared on the DishDrawer®. This information will help the Authorized Service Center respond to your request.

Fault Codes	Possible Causes	What to Do
F1  	Flood switch has been activated.	Turn the water and power supply to the DishDrawer® off and call your Authorized Service Center.
F2  	Motor problem.	Call your Authorized Service Center.
F3  	Temperature sensor failed.	Ensure water coming in through the inlet hose is less than 150 °F. You may need to install a tempering valve on your water supply.
F4  	Faulty temperature sensor or element	Call your Authorized Service Center.
F5  	Lid fault	<ol style="list-style-type: none"> 1 Turn power supply to DishDrawer off, then turn on power supply. Fault may reset. 2 Call your Authorized Service Center.
F6  	Lid fault	<ol style="list-style-type: none"> 1 Turn power supply to DishDrawer off, then turn on power supply. Fault may reset. 2 Call your Authorized Service Center.
F7  	Lid fault	Call your Authorized Service Center.
F8  	Electrical problem	<ol style="list-style-type: none"> 1 Turn power supply to DishDrawer off. 2 Call your Authorized Service Center.
F9  	Electronics malfunction.	Call your Authorized Service Center.

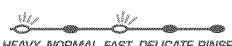
Fault Codes	Possible Causes	What to Do
U1  	Fill Fault	<ol style="list-style-type: none"> 1 Turn the DishDrawer® water supply on. 2 Ensure the spray arm is placed on the impeller and can rotate and if the DishDrawer® is full of water, it will need to be emptied manually. 3 Call your Authorized Service Center.
U4  	Fault in the other drawer preventing the use of this drawer	Check other drawer, attend to fault code on that drawer.

Before you call for service or assistance ...

Check the things you can do yourself. Refer to the installation instructions and your user guide and check that:

- 1 your product is correctly installed
- 2 you are familiar with its normal operation.

If after checking these points you still need assistance, please refer to the Service & Warranty book for warranty details and your nearest Authorized Service Center, or contact us through our website listed on the back cover.

Copyright © Fisher & Paykel 2009. All rights reserved.

The product specifications in this booklet apply to the specific products and models described at the date of issue. Under our policy of continuous product improvement, these specifications may change at any time. You should therefore check with your Dealer to ensure this booklet correctly describes the product currently available.

Droits réservés © Fisher & Paykel 2009.

Les spécifications du produit contenues dans ce manuel s'appliquent aux modèles et produits spécifiques comme décrits à la date de publication. Dans le cadre de notre politique d'améliorations en permanence de nos produits, ces spécifications pourront être modifiées à tout moment. Nous vous recommandons de vérifier auprès de votre revendeur que ce manuel décrit le produit actuellement disponible.

www.fisherpaykel.com

www.fisherpaykel.ca

US/CA

DishDrawer user guide

Published: 02/2009

Part No. 599595 B