

This Owner's Manual is provided and hosted by [Appliance Factory Parts](#).



# FISHER & PAYKEL DD24DI9N Owner's Manual

[Shop genuine replacement parts for FISHER & PAYKEL  
DD24DI9N](#)



[Find Your FISHER & PAYKEL Dishwasher Parts - Select From 34 Models](#)

----- Manual continues below -----

*Fisher & Paykel*

**User guide**

US CA NZ AU GB IE

---

This user guide is an accompaniment to your 'Quick start guide' which is included with your dishwasher.

For operating instructions, see your 'Quick start guide'. If you no longer have your 'Quick start guide', you can download it from our local website, listed on the back cover.

**Refer to your 'Quick start guide' for information on:**

- Starting a wash
  - Wash programs and when to use them
  - Controls
  - Dos and don'ts of loading
  - Preference options and how to change their settings
-

Electrical connection (GB IE only)	2
Safety and warnings	3
Caring for your dinnerware	7
Racking features	8
Loading suggestions	12
Water hardness and dishwashing	13
Wash programs and detergent quantities	14
Adding detergent	16
Using rinse aid	18
Water softener	19
User maintenance instructions	22
Troubleshooting	30
If there is a fault	33
How to attend to a fault	
Classic models	34
Designer models	36
Integrated models with badge	38
Integrated models with remote control	40
Warranty and service	42
Wash program data	44
Standards test	
USA and Canada	52
New Zealand and Australia	54
Great Britain and Ireland	56

## ***Important!***

### **SAVE THESE INSTRUCTIONS**

*The models shown in this user guide may not be available in all markets and are subject to change at any time. For current details about model and specification availability in your country, please visit our local website listed on the back cover or contact your local Fisher & Paykel dealer.*

## 2 Electrical connection (GB IE only)

### For Great Britain only

#### **Important!**

*This appliance must be earthed.*

#### Fuse replacement

The mains lead of this appliance is fitted with a BS 1363A 13 A fused plug. To change a fuse in this type of plug, use an ASTA approved fuse to BS 1362 type and proceed as follows:

- 1 Remove the fuse cover and fuse.
- 2 Fit the replacement 13A fuse into the fuse cover.
- 3 Refit both into plug.

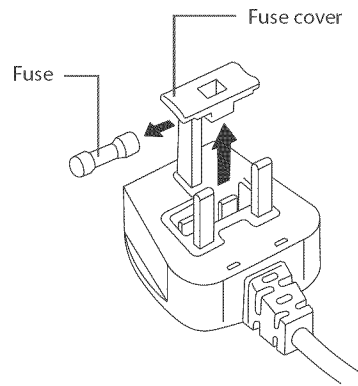

#### **Important!**

- *The fuse cover must be refitted when changing a fuse and if the fuse cover is lost, the plug must not be used until a correct replacement is fitted.*
- *Correct replacements are identified by the colour insert or the colour embossed in words on the base of the plug.*
- *Replacement fuse covers are available from your local electrical store.*

### For the Republic of Ireland

The information given in respect to Great Britain will frequently apply, but a third type of plug and socket is also used: the 2-pin, side earth type.

#### Socket outlet / plug (valid for both countries)

If the fitted plug is not suitable for your socket outlet, please contact an Authorised Service Agent. Please do not attempt to change the plug yourself. This procedure must be carried out by a qualified service technician in compliance with the manufacturer's instructions and current standard safety regulations.

Your dishwasher has been carefully designed to operate safely during normal dishwashing procedures. Please keep the following instructions in mind when you are using your dishwasher.

### **IMPORTANT SAFETY INSTRUCTIONS**

*WARNING! - When using your dishwasher, follow basic precautions, including the following:*

- *Read all instructions before using the dishwasher.*
- *The information in this manual must be followed to minimise the risk of fire or explosion or to prevent property damage, personal injury or loss of life.*
- *Use the dishwasher only for its intended function as described in this user guide and in your 'Quick start guide'.*
- *This appliance is intended to be used in household and similar applications such as:*
  - *staff kitchen areas in shops, offices and other working environments;*
  - *farm houses;*
  - *by clients in hotels, motels and other residential type environments;*
  - *bed and breakfast type environments.*
- *Use only detergents or rinse aid recommended for use in a domestic dishwasher and keep them out of reach of children. Check that the detergent dispenser is empty after the completion of each wash program.*
- *When loading items to be washed, locate sharp items so that they are not likely to damage the internal lid of the dishwasher and load sharp knives with the handle up to reduce the risk of cut-type injuries.*
- *Do not touch the filter plate (the round metal disc in the dishwasher base) during or immediately after use, as it may be hot from the heater plate underneath.*
- *Do not operate your dishwasher unless all enclosure panels are properly in place.*
- *Do not tamper with the controls.*
- *Do not abuse, sit on, stand in or on the drawer or dish rack of the dishwasher.*
- *The drawer should not be left in the open position since this could present a tripping hazard.*
- *The adjustable racks are designed to support cups, glasses and kitchen utensils. When the adjustable racks are in the drawer do not lean on or use them to support your body weight.*
- *To reduce the risk of injury, do not allow children to play in or on the dishwasher.*
- *Under certain conditions, hydrogen gas may be produced in a hot water heater system that has not been used for two weeks or more. HYDROGEN GAS IS EXPLOSIVE. If the hot water system has not been used for such a period, before using the dishwasher, turn on all hot water taps and let the water flow from each for several minutes. This will release any accumulated hydrogen gas. As the gas is flammable, do not smoke or use an open flame during this time.*
- *Remove the door to the washing compartment when removing an old dishwasher from service or discarding it.*
- *Some dishwasher detergents are strongly alkaline. They can be extremely dangerous if swallowed. Avoid contact with the skin and eyes and keep children away from the dishwasher when the door is open. Check that the detergent receptacle is empty after completion of the wash cycle.*

## IMPORTANT SAFETY INSTRUCTIONS

### Installation

- *This dishwasher must be installed and located in accordance with the Installation instructions before it is used. If you did not receive Installation instructions with your dishwasher, you can order them by calling your Authorised Repairer or download them from our local Fisher & Paykel website, listed on the back cover.*
- *Installation and service must be performed by a qualified technician.*
- *If the power supply cord is damaged, it must be replaced by a dealer or Authorised Repairer or a similar qualified trades person in order to avoid a hazard.*
- *Ensure the dishwasher is secured to adjacent cabinetry using the brackets provided. Failure to do so may result in an unstable product, which may cause damage or injury.*
- *Do not operate this appliance if it is damaged, malfunctioning, partially disassembled or has missing or broken parts, including a damaged power supply cord or plug.*
- *Do not store or use petrol, or other flammable vapours and liquids in the vicinity of the dishwasher.*
- *Connect to a properly rated, protected and sized power supply circuit to avoid electrical overload.*
- *Make sure that the power supply cord is located so that it will not be stepped on, tripped over or otherwise subject to damage or stress.*
- *Do not install or store the dishwasher where it will be exposed to temperatures below freezing or exposed to weather.*
- *Do not use an extension cord or a portable electrical outlet device (e.g. multi-socket outlet box) to connect the dishwasher to the power supply.*
- *This appliance must be grounded. In the event of a malfunction or breakdown, grounding will reduce the risk of electric shock by providing a path of least resistance for electric current. This appliance is equipped with a cord having an equipment-grounding conductor and a grounding plug. The plug must be plugged into an appropriate outlet that is installed and grounded in accordance with all local codes and ordinances. WARNING - Improper connection of the equipment-grounding conductor can result in a risk of electric shock. Check with a qualified electrician or service representative if you are in doubt as to whether the appliance is properly grounded. Do not modify the plug provided with the appliance; if it will not fit the outlet, have a proper outlet installed by a qualified technician.*
- *If the dishwasher is installed as a permanently connected appliance:  
GROUNDING INSTRUCTIONS - This appliance must be connected to a grounded metal, permanent wiring system, or an equipment-grounding conductor must be run with the circuit conductors and connected to the equipment-grounding terminal or lead on the appliance.*

## IMPORTANT SAFETY INSTRUCTIONS

### Maintenance

- *Disconnect the appliance from the power supply before any cleaning or maintenance.*
- *When disconnecting the appliance pull the plug rather than the power supply cord or junction of cord to avoid damage.*
- *Do not repair or replace any part of the appliance or attempt any servicing unless specifically recommended in this user guide. We recommend that you contact Customer Care to arrange service. See your 'Service and warranty' booklet for contact details.*
- *Keep the floor around your appliance clean and dry to reduce the possibility of slipping.*
- *Keep the area around/underneath your appliance free from the accumulation of combustible materials, such as lint, paper, rags and chemicals.*
- *Models with a remote control: Do not attempt to recharge, short-circuit, disassemble, heat or throw the remote control battery into a fire. Dispose of an old battery responsibly, keeping it out of reach of children.*

### Operational

- *Under no circumstances should you open the drawer whilst the dishwasher is in operation.*
- *Always press the ▶|| button to pause and wait until you hear the three additional beeps before opening the drawer.*
- *The dishwasher must be used with the motor assembly, filter plate, drain filter and spray arm(s) in place. To identify what these parts are, see drawings in section 'User maintenance instructions' of this user guide.*
- *Take care when loading the drawer not to load dishware items so they prevent the internal lid from properly sealing with the drawer. Items should be placed so they do not protrude above and/or forced into the drawer, otherwise a service call may result.*
- *Household appliances are not intended to be played with by children. Children or persons with a disability which limits their ability to use the appliance, should have a responsible person instruct them in its use. The instructor should be satisfied that they can then use the appliance without danger to themselves or their surroundings.*
- *Close supervision is necessary if this appliance is used by or near children. Do not allow children to play inside, on or with this appliance or any discarded appliance.*
- *If a dishwasher cleaner is used, we would strongly recommend a wash program with detergent should be run immediately afterward, to prevent any damage to the dishwasher.*
- *The dishwasher is designed for washing normal household utensils. Items that are contaminated by petrol, paint, steel or iron debris, corrosive, acidic or alkaline chemicals are not to be washed in the dishwasher.*
- *If the dishwasher is not being used for long periods of time, turn the electricity and water supply to the dishwasher off.*

## IMPORTANT SAFETY INSTRUCTIONS

### Operational - models with remote control

- *To prevent unauthorized use, keep the remote control out of reach of children.*
- *Make sure that you keep the remote away from water and steam. Do not immerse and take care not to drop the remote control into water. This may damage the parts or lead to malfunction. Damage or malfunction caused by exposure to water or steam is not covered by warranty.*
- *Do not drop, step on or otherwise impact the remote control. This may damage the parts or lead to malfunction.*
- *This device complies with part 15 of the FCC Rules. Operation is subject to the following two conditions: (1) This device may not cause harmful interference, and (2) this device must accept any interference received, including interference that may cause undesired operation.*
- *Do not tamper with or modify the remote control or the dishwasher in any way, as doing so will void the certification of the device.*
- *This device complies with Industry Canada licence-exempt RSS standard(s). Operation is subject to the following two conditions: (1) this device may not cause interference, and (2) this device must accept any interference, including interference that may cause undesired operation of the device.*
- |  |
|--|
| Complies with<br>IDA Standards<br>DB104887 |
|--|

SAVE THESE INSTRUCTIONS

The combination of high temperatures and dishwasher detergent may cause damage to some items if they are washed in the dishwasher. Remember, if in any doubt about any aspect concerning items washed in the dishwasher, follow the instructions from the manufacturer of the items, or wash the item by hand.

### **Cutlery & silverware**

All cutlery and silverware should be rinsed immediately after use to prevent tarnishing caused by some foods. The Rinse wash program is useful for this. Silver items should not come into contact with stainless steel, eg other cutlery. Mixing these items can cause staining. Remove silver cutlery from the dishwasher and hand dry it immediately after the program has finished.

### **Aluminium**

Aluminium can be dulled by dishwasher detergent. The degree of change depends on the quality of the product.

### **Other metals**

Iron and cast iron objects can rust and stain other items. Copper, pewter and brass tend to stain.

### **Woodware**

Wooden items are generally sensitive to heat and water. Regular use in the dishwasher may cause deterioration over time. If in doubt, wash by hand.

### **Glassware**

Most everyday glassware is dishwasher safe. Crystal, very fine and antique glassware may etch that is, become opaque. You may prefer to wash these items by hand.

### **Plastic**

Some plastic may change shape or colour with hot water. Check manufacturer's instructions about washing plastic items. Washable plastic items should be weighed down so they do not flip over and fill with water or fall through the base rack during the wash. Use the multi-purpose clip (supplied with some models only) to hold plastic items in place.

### **Decorated items**

Most modern china patterns are dishwasher safe. Antique items, those with a pattern painted over the glaze, gold rims or hand painted china may be more sensitive to machine washing. If in doubt, wash by hand.

### **Glued items**

Certain adhesives are softened or dissolved in machine washing. If in doubt, wash by hand.

## 8 Racking features

### Cutlery basket

- To reduce the risk of injury, we recommend loading knives and sharp utensils with handles facing up.
- Mix spoons, knives and forks within each section to stop cutlery nesting together and to ensure the water circulates freely.
- Keep stainless steel from touching silver cutlery to avoid staining.

### Removable small items container

- Small, light items like baby bottle teats are best placed into the small items container to prevent them from being displaced during the wash.
- You can extend your cutlery basket by clipping the container on its side.

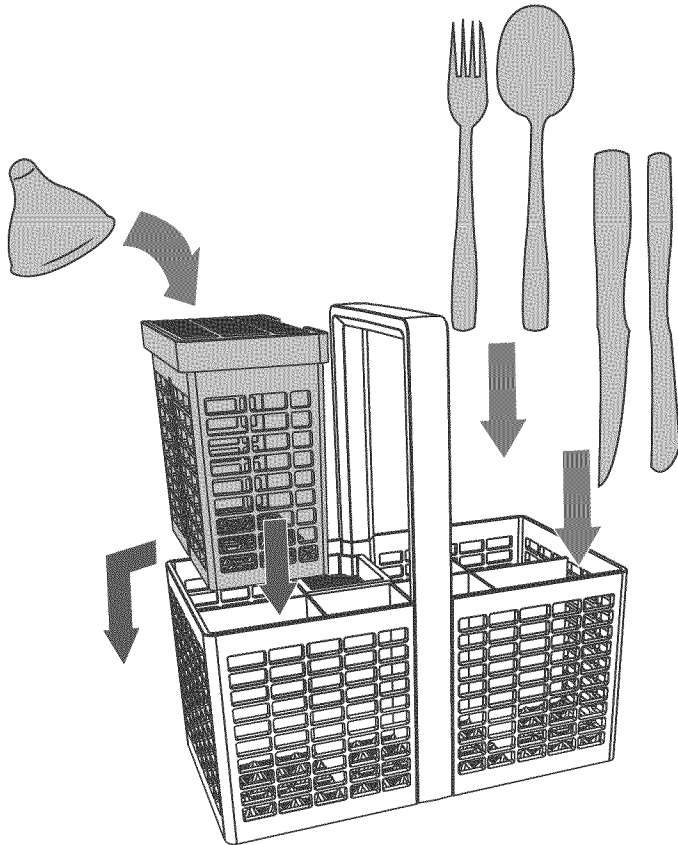

*Cutlery baskets will vary depending on model.*

### Removable small items container

- To optimise the cutlery space within the basket, the small items container can be placed elsewhere on the base rack. If laid flat, make sure the solid plastic side is facing up.
- If you place a fully laden small items container under the adjustable racks, it is best to leave the rack space directly above the container empty: there may not be enough water reaching items that are placed there.

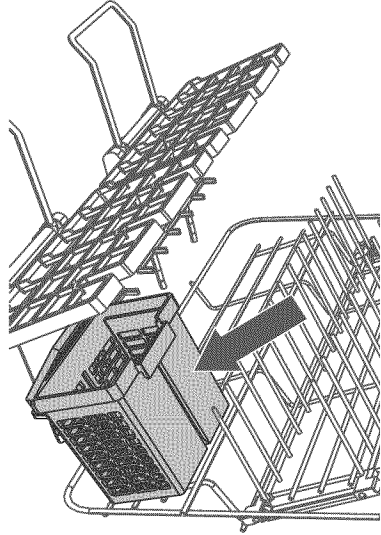

### Removable tablet tray

- If you are using dishwasher tablets, place them on the removable tablet tray, as shown. See also 'Adding detergent' for more information.

### **Important!**

*Dishwasher tablets should not be in direct contact with dishes or cutlery.*

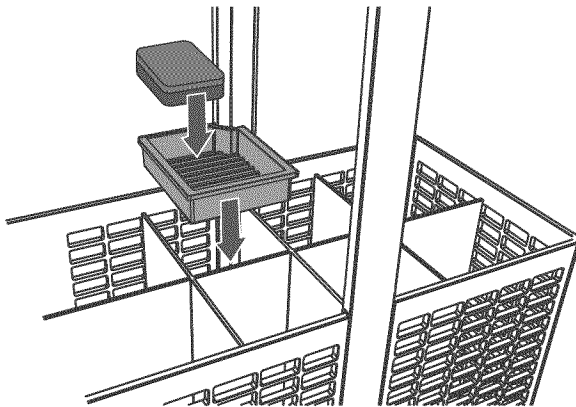

## 10 Racking features

*Racking features will vary depending on model.*

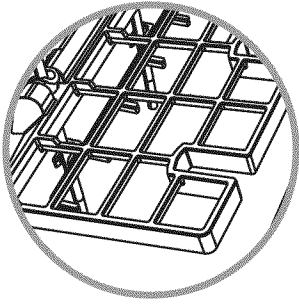

### Stemware notches

- These notches help support long-stemmed glassware.

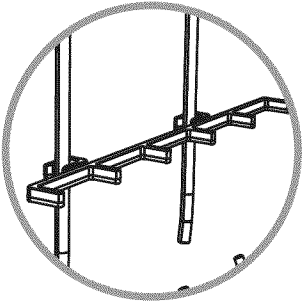

### Glass supports

- These clip on the rack wires to give your tall glasses extra stability.

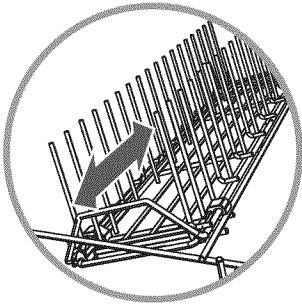

### Spacing-adjustable tines

*(DD24/DD60 models only)*

- Designed to fit deep bowls (wide spacing) or small plates (narrow spacing), depending on adjustment.
- To adjust between wide and narrow spacings, slide the tines backward or forward by the handle at the front.

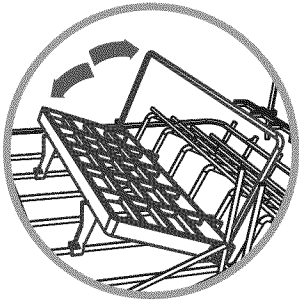

### Cup rack with folding support wire

*(DD36/DD90 models only)*

- Fold the wire up to support tall glasses.

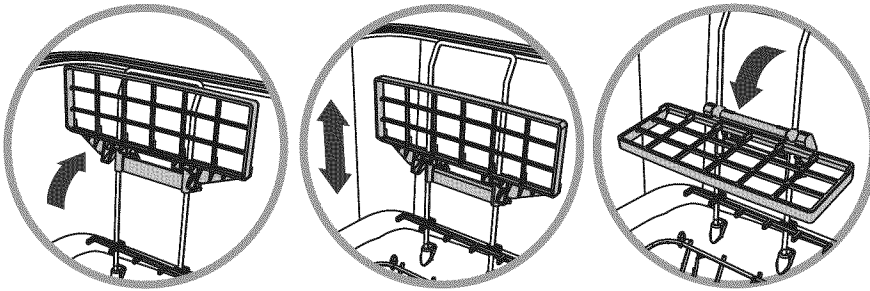

### Adjustable racks

- You can adjust these independently of each other to any height:
  - 1 Fold up to unlock the rack.
  - 2 Adjust the height to suit by sliding up or down.
  - 3 Fold down to lock in position.
- Fold the racks away if you need the space.

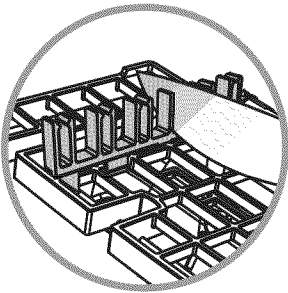

### Knife clip

- This clips onto the adjustable racks and supports knives and other utensils during the wash.
- Always ensure that knife blades are facing down.

### Multi-purpose clip

*(DD36/DD90 models only)*

- This keeps flimsy items (eg plastic lids and bottles) or large platters and plates stable, so they cannot be dislodged during the wash.
- Slide the item between the prongs of the clip.

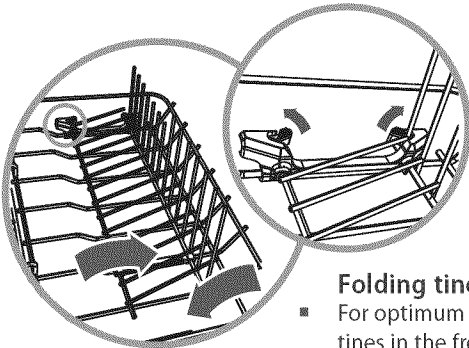
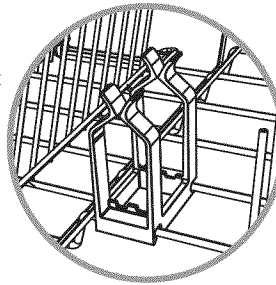

### Folding tines

- For optimum stability, place larger plates between the longer tines in the front.
- Release and fold the tine sections down towards each other if you need the space for pots or other large items.

## 12 Loading suggestions

- **When loading your drawer, make sure that**
  - you place items so that water coming from the rotating spray arms below can reach all areas (wash performance will be reduced if it can't)
  - nothing blocks the water from getting to items on the adjustable racks
  - glass and other fragile items are stable, so that they do not accidentally topple and break during the wash.

### How NOT to load your drawer

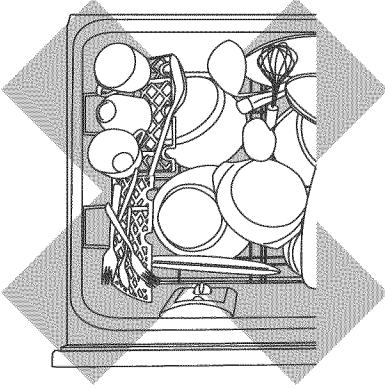

- Overcrowded and wash water will not reach some of the dinnerware.
- Cups, glasses and bowls must have their openings facing down.

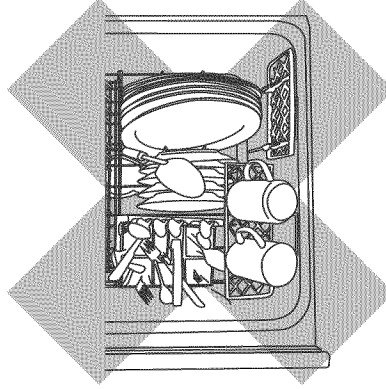

- The plates are nesting together and wash water may not get through.
- Ensure cutlery are not nesting or stuck together. They need to be evenly spread out.

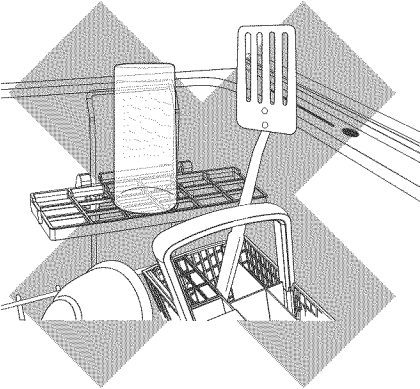

- Ensure dishware items are not forced into or protrude out of the drawer, as this may prevent the internal lid of the drawer from properly sealing which could result in a service call.
- Locate sharp items safely to prevent injuring the user and damaging the lid assembly.
- Check the bottom of the cutlery basket to ensure sharp or pointed items have not come through as they may stop spray arm rotation.

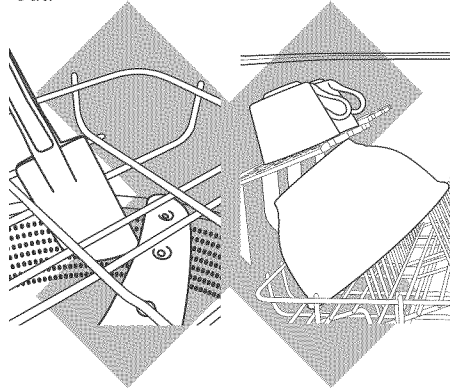

- Ensure cutlery has not fallen through the base rack and stopped the spray arms from rotating.
- The large bowl is blocking wash water reaching the adjustable racks.
- Large utensils should be on the adjustable racks so they do not become dislodged and stop the spray arms from rotating.
- Sharp or pointed items must be placed horizontally or with sharp edges/points facing down to avoid risk of injury.

## What is water hardness?

Hard water is water with a high concentration of minerals such as calcium and magnesium. In soft water, this concentration is low. Water hardness varies by geographical location.

## How does water hardness affect dishwashing?

- Hard water can be detrimental to the performance of your dishwasher. Over time, glassware washed in hard water will become opaque and dishes will become spotted or covered in a white film. Using very hard water can cause dishwasher parts to fail over time.
- Naturally soft or softened water has no detrimental effects if used with the correct amount of detergent. However, excess detergent combined with hot, soft water may cause irreversible etching on glassware. Etching first appears as a rainbow-coloured film and—if allowed to continue—can make glassware permanently opaque.

## What can I do to minimise any detrimental effects?

Contact your local water company to find out about water hardness in your area.

### **If your home has hard water and your dishwasher has no built-in water softener...**

- Follow the detergent quantity recommendations on the following pages.
- If available, use a detergent with high phosphate content. Phosphate softens the water and this improves wash results. If detergent with phosphate is not available, we recommend using multi-purpose tablets.
- Use rinse aid. We recommend you turn the rinse aid setting to 5 to help improve wash performance.
- Use a dishwasher cleaner/descaler regularly, or whenever you notice a build-up of limescale deposits in your dishwasher.

- ***Important!***

*We recommend fitting a water softener to the household water supply. If the water hardness in your home is above 250 ppm/14.6 gpg, a water softener has to be fitted to maintain the performance of your dishwasher.*

### **If your home has naturally soft or softened water...**

- Avoid using too much detergent. Follow the quantity recommendations on the following pages.
- Ensure the drawer is not overloaded and water can reach all the dishes.

## 14 Wash programs and detergent quantities

### DD24/DD60 models

- Find out about water hardness in your home, then use the table below to determine how much detergent to use for each wash program. See also section 'Water hardness and dishwashing'.
- For information on which program to use for your load, see your 'Quick start guide'.
- The detergent dispenser has markings to help you measure the correct quantities. See following section 'Adding detergent'.

	Water hardness <i>parts per million (ppm)</i> <i>grains per gallon (gpg)</i>	Wash programs	Detergent quantities (per drawer)		
			US CA	NZ AU	GB IE
			<i>detergent dispenser marking</i>	<i>grams</i>	<i>grams</i>
SOFTER	< 100 ppm or < 6 gpg*	Heavy	2/3	25	25
		Normal	2/3	25	25
		Fast	1/3	10	10
		Delicate	1/3	10	10
		Rinse	-	-	-
	100 - 150 ppm or 6 - 9 gpg	Heavy	full	30	
		Normal	full	30	
		Fast	full	25	
		Delicate	full	30	
		Rinse	-	-	
	> 150 ppm or > 9 gpg	Heavy	full	30	
		Normal	full	30	
		Fast	full	30	
		Delicate	full	30	
		Rinse	-	-	
HARDER					

\* If you have a household water softener installed or your dishwasher has a built-in water softener, use the quantities recommended for water with a hardness under 100 ppm/6 gpg, irrespective of the water hardness in your area. See also section 'Water softener'.

## DD36/DD90 models

- Find out about water hardness in your home, then use the table below to determine how much detergent to use for each wash program. See also section 'Water hardness and dishwashing'.
- For information on which program to use for your load, see your 'Quick start guide'.
- The detergent dispenser has markings to help you measure the correct quantities. See following section 'Adding detergent'.

	Water hardness <i>parts per million (ppm)</i> <i>grains per gallon (gpg)</i>	Wash programs	Detergent quantities		
			US CA	NZ AU	GB IE
			<i>detergent dispenser marking</i>	<i>grams</i>	<i>grams</i>
SOFTER	<100 ppm or < 6 gpg*	Heavy	<b>full</b>	<b>30</b>	<b>30</b>
		Normal	<b>full</b>	<b>25</b>	<b>25</b>
		Fast	<b>2/3</b>	<b>15</b>	<b>15</b>
		Delicate	<b>2/3</b>	<b>15</b>	<b>15</b>
		Rinse	-	-	-
	100 -150 ppm or 6 - 9 gpg	Heavy	<b>full</b>	<b>30</b>	
		Normal	<b>full</b>	<b>30</b>	
		Fast	<b>2/3</b>	<b>20</b>	
		Delicate	<b>full</b>	<b>30</b>	
		Rinse	-	-	
	>150 ppm or >9 gpg	Heavy	<b>full</b>	<b>30</b>	
		Normal	<b>full</b>	<b>30</b>	
		Fast	<b>full</b>	<b>30</b>	
		Delicate	<b>full</b>	<b>30</b>	
		Rinse	-	-	
HARDER					

\* If you have a household water softener installed or your dishwasher has a built-in water softener, use the quantities recommended for water with a hardness under 100 ppm/6 gpg, irrespective of the water hardness in your area. See also section 'Water softener'.

## 16 Adding detergent

### Suitable detergents and where to place them

Note: You may see other, equally suitable types of dishwasher detergent on the shelves of your supermarket. Read and follow the detergent manufacturer's recommendations.

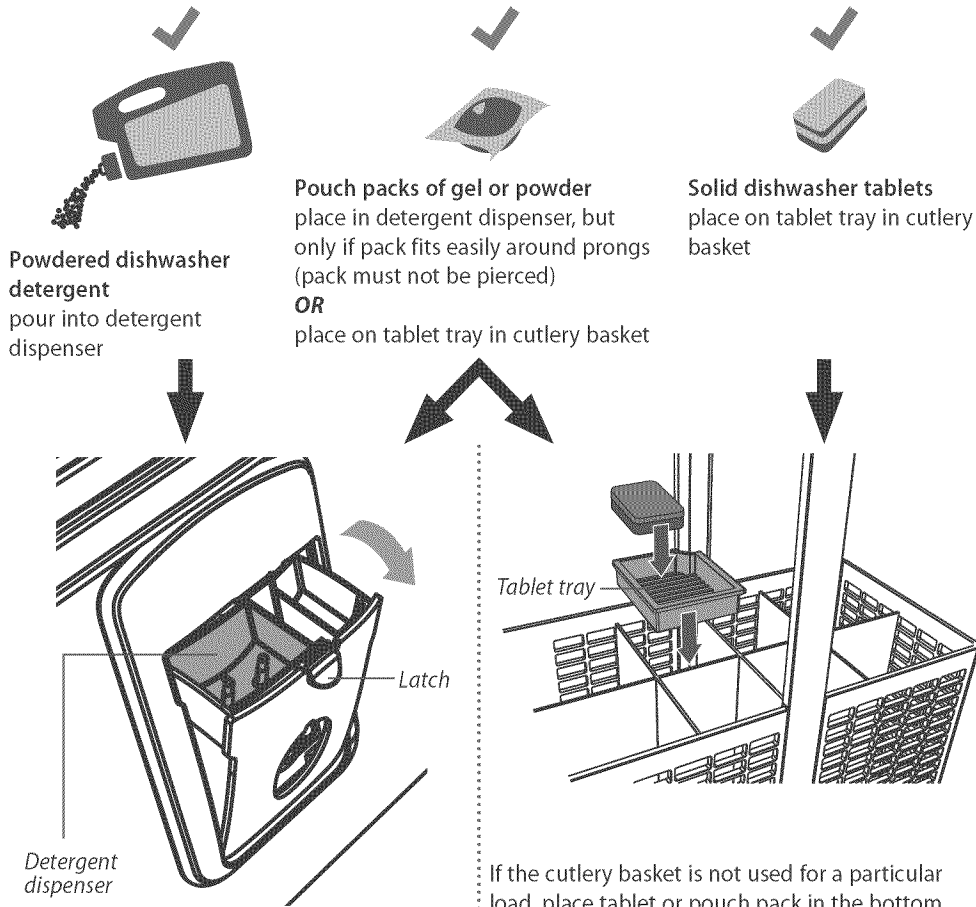

**Pouch packs of gel or powder**  
place in detergent dispenser, but  
only if pack fits easily around prongs  
(pack must not be pierced)  
**OR**  
place on tablet tray in cutlery basket

**Solid dishwasher tablets**  
place on tablet tray in cutlery  
basket

If the cutlery basket is not used for a particular load, place tablet or pouch pack in the bottom of the drawer.

#### Filling the detergent dispenser

- 1 Press the latch down to open the dispenser.
- 2 Check that the dispenser is empty and dry, then add detergent (do not place solid tablets in the dispenser). No detergent is needed for the Rinse program.
- 3 Close the dispenser until it clicks shut. The detergent will automatically be released into the drawer during the wash program.

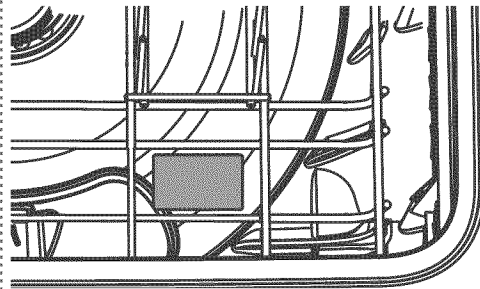

## Unsuitable detergents

These types of detergent are not suitable and may damage your dishwasher or lead to a service call that is not covered by warranty.

### **Important!**

*Do not use these in your dishwasher!*

- *Liquid detergents*
- *Laundry detergents*
- *Hand washing liquids*
- *Soaps*
- *Disinfectants*

## How much detergent to use

For powdered detergent, refer to previous section 'Wash programs and detergent quantities' and follow the quantities relevant to your location and water hardness level. Use the markings to help you measure the correct quantities. For other types of detergent, follow the manufacturer's recommendations.

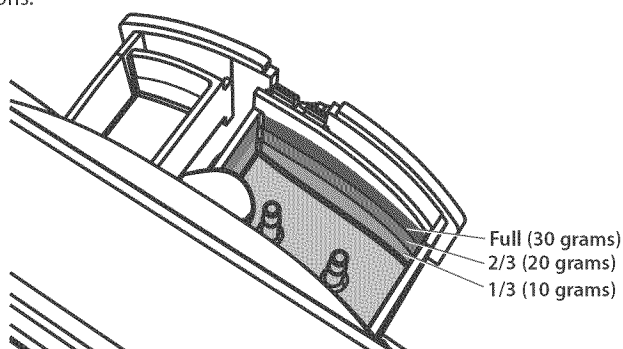

### Notes on using tablets

- If you are using tablets, follow manufacturer instructions on the packet. Some tablets may not be suitable for all wash programs.
- Using tablets could improve wash performance in hard water areas.
- Make sure that tablets never get in direct contact with dishes or cutlery.
- If you are using dishwasher tablets with a built-in rinse aid component, you may need to reduce the rinse aid setting. See your 'Quick start guide' for instructions.

### **Important!**

*Dishwasher detergents are strongly alkaline. They can be extremely dangerous if swallowed. Avoid contact with the skin and eyes and keep children and infirm persons away from the dishwasher when it is open. Check that the detergent dispenser is empty after completion of the wash program.*

## 18 Using rinse aid

- We recommend using liquid rinse aid regularly to give the best drying results.
- Rinse aid gives a streak-free, sparkling clean look to glass and chinaware. It also prevents metal from tarnishing.
- The rinse aid dispenser is on the inside of the drawer, underneath the detergent dispenser. It holds approximately 1.7 fl oz / 50 ml of rinse aid.
- You may hear some unusual, high-pitched beeping when rinse aid is being dispensed. This is normal.

### When to refill rinse aid

- If the indicator glows or flashes bright red, refill rinse aid.
- If the indicator glows or flashes dimly or not at all, you do not need to refill: there is enough rinse aid for the wash.

Note: Lighter coloured rinse aids will not dim the indicator as effectively as darker ones.

### How to refill rinse aid

- 1 Turn the plug anticlockwise and remove.
- 2 Pour rinse aid into the circular opening, taking care not to spill any into the drawer.

#### **Important!**

*Any accidental spillages of rinse aid must be wiped up. If not wiped up, spilt rinse aid will cause excessive foaming, resulting in a service call that will not be covered by warranty.*

- 3 Refit the plug, then turn it clockwise back to its original position.

#### **Important!**

*Make sure that the plug is closed tight, with its hand grip pointing straight ahead.*

### How much rinse aid to use

You may need to adjust the amount of rinse aid dispensed in each wash to suit your water conditions. The lowest setting is '1', the highest is '5'. See the 'Preference options' section of your 'Quick start guide' for instructions on how to change the rinse aid setting.

- If there is excessive foam at the end of the wash, reduce the setting.
- If dishes are wet or streaky after drying, increase the setting.
- If you live in a hard water area and you have no water softener installed in your water supply or built into your dishwasher, we recommend adjusting the rinse aid setting to 5.

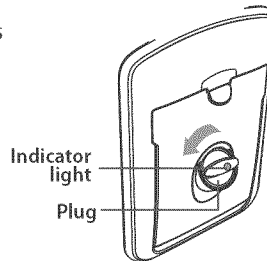

Turn the plug anticlockwise.

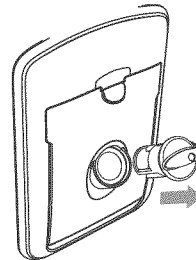

Remove the plug

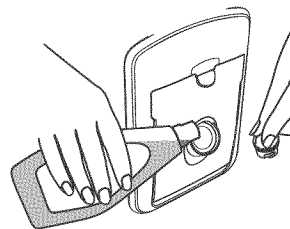

Pour rinse aid into the circular opening

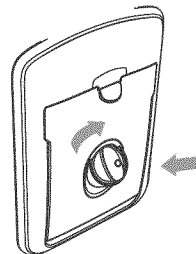

Refit the plug by turning it clockwise. Ensure it is closed tight.

## Setting up the water softener

### **Important!**

Only some models (those with a letter 'H' in the model name) have a built-in water softener.

Models with water softener are not currently available in New Zealand and Australia.

### Determine the water hardness in your local area

Your local water company will be able to provide you with information. Identify the setting you require for your dishwasher from the water hardness table below. For example, if your water hardness is 500ppm, then the water softener setting on your dishwasher should be 4. Refer to the 'Preference options' section of your 'Quick start guide' for instructions on adjusting the water softener setting.

Dishwasher setting	Parts per million (ppm)	Grains per gallon (gpg)	°dH	°fH	°e / °Clark	mmol/l
0	0 - 100	0 - 6	0 - 5.6	0 - 10	0 - 7	0 - 0.1
1	100 - 250	6 - 14	5.6 - 14	10 - 25	7 - 17.5	0.1 - 2.5
2	250 - 350	14 - 20	14 - 19.6	25 - 35	17.5 - 24.5	2.5 - 3.5
3	350 - 450	20 - 26	19.6 - 25.2	35 - 45	24.5 - 31.5	3.5 - 4.5
4	450 - 550	26 - 32	25.2 - 30.8	45 - 55	31.5 - 38.5	4.5 - 5.5
5	550 - 625	32 - 36	30.8 - 35	55 - 62	38.5 - 43.8	5.5 - 6.2

## 20 Water softener

### Notes:

- If your water hardness is above 625ppm/36 gpg, we highly recommend you completely fill the detergent dispenser for all programs except Rinse and the rinse aid setting should be at 5. If your water hardness is above 625ppm/36 gpg, the wash performance of your dishwasher will decline.
- You may hear some unusual noises when the water softener is in operation, this is normal.

### How to fill the salt reservoir

- 1 Open the drawer(s).
- 2 Unscrew the salt reservoir cap by turning anticlockwise.
- 3 Place the salt into the salt container and pour the contents into the salt reservoir.  
The salt reservoir can hold up to approximately 1 lb/0.5 kg of salt.
- 4 Fit the cap tightly back into its original position.
- 5 If you do not wash your dishes immediately after filling the salt reservoir, run a Rinse program to remove any salt water or spilt granules.

### Note:

When filling the salt reservoir, you may notice water being displaced from the water softener overflow.

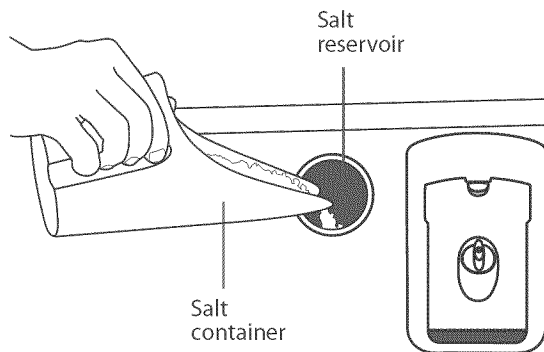

**Important!**

The water softener must always be filled with granular salt made especially for dishwasher water softening systems. We do not recommend the use of cooking salt like table salt, rock salt or pellets as they may contain impurities that will impair or diminish the life of the water softener.

**The salt reservoir**

Water softening can only take place when there is salt in the reservoir. The salt reservoir must be filled prior to using the dishwasher and whenever the salt indicator light is red.

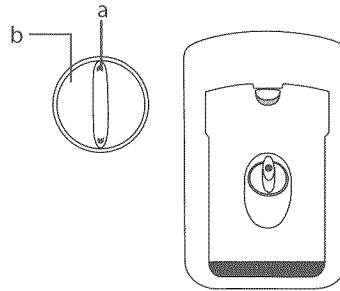

a Salt indicator light  
b Salt reservoir cap

**Salt indicator light**

- If the salt indicator light is red, the salt reservoir is empty.
- If the salt indicator light is black, there is enough salt in the reservoir for the wash program that has been selected.
- Classic models only: The electronic display will also indicate when the salt reservoir is empty by displaying the salt symbol.

**Important!**

Do not pour detergent or rinse aid into the salt reservoir. Detergent and rinse aid will destroy the water softener.



Salt only

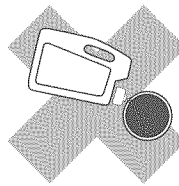

NO Detergent

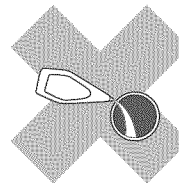

NO Rinse Aid

### **Important!**

*Disconnect the dishwasher from the power supply (unplug or switch off at the circuit breaker) and allow all its parts to cool before any cleaning or maintenance.*

#### **Holiday time**

- If the dishwasher is not going to be used for some time, we recommend you leave it clean and empty. Leave the drawer(s) ajar to allow air to circulate. Turn off both the power and water supply to the dishwasher.
- When using your dishwasher for the first time after a long period away, we recommend pouring 3 cups of water into the drawer before loading and starting a wash. This is to lubricate components that may have dried out during non-use.

#### **Cleaning the surfaces**

- 1 Wipe with a clean damp cloth. Take care not to wet the control panel.
- 2 Dry with a clean lint-free cloth.

### **Important!**

*We do not recommend the use of the following cleaning aids on your dishwasher as they may damage the surfaces:*

- |  |   |
|--|---|
| ■ Plastic or stainless steel scouring pads | ■ Abrasive, solvent, household cleaners |
| ■ Acid or alkaline cleaners                | ■ Hand washing liquids or soap          |
| ■ Stainless steel cleaners or polishes     | ■ Laundry detergents or disinfectants   |

#### **Cleaning the drain filter, spray arm and filter plate**

- We recommend that the drain filter is cleaned whenever there is evidence of food particles.
- The spray arm may need cleaning about once a month in normal use or more often should the need arise.
- The filter plate should not normally need cleaning. Food particles remaining on its surface can be wiped off with a clean, damp cloth.

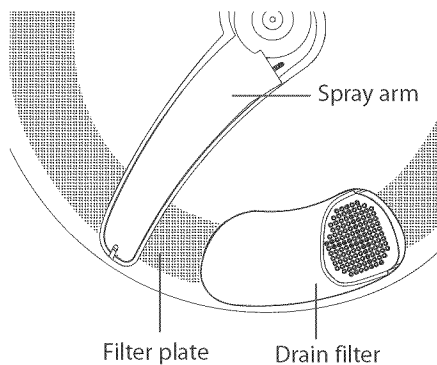

**Important!**

- If a dishwasher cleaner/descaler is used, you must run a wash program with detergent immediately afterward to prevent any damage to your dishwasher.
- The dishwasher must be used with the filter plate, drain filter and spray arm correctly in place.

**Cleaning the drain filter**

- 1 Unplug the dishwasher or turn it off at the power supply.
- 2 To access the drain filter, lift up the plastic grid above it, as shown.
- 3 Lift and remove the drain filter. It is normal to find some water under it.
- 4 Empty, rinse clean under running water and replace back into the allocated space.
- 5 Ensure the drain filter is flush with the filter plate, then lower the plastic grid back into place.
- 6 Plug the dishwasher back in or turn it on at the power supply.

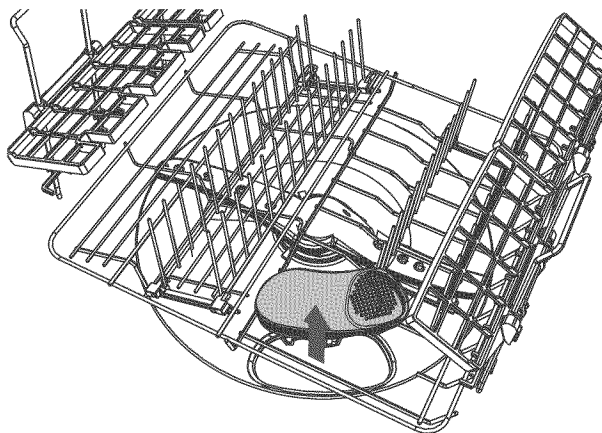
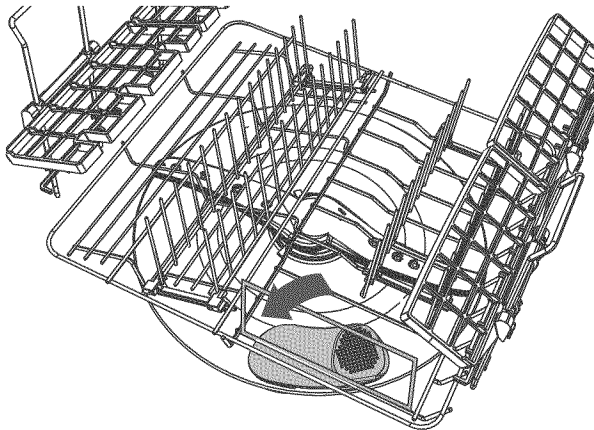

### Cleaning the spray arm and filter plate

#### *To remove and clean the spray arm and filter plate*

- 1 Unplug the dishwasher or turn it off at the power supply.
- 2 Unclip the glass supports (if fitted) from the rack wires and fold all the adjustable racks away, so that they are upright and close to the top.
- 3 Remove the base rack carefully. Lift from the back end first to prevent knocking the detergent and rinse aid dispenser.
- 4 Lift the spray arm and shake any foreign material out. Rinse it clean under running water and wipe with a damp cloth.
- 5 Lift and remove the drain filter.

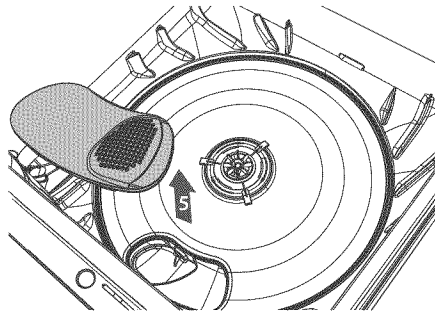
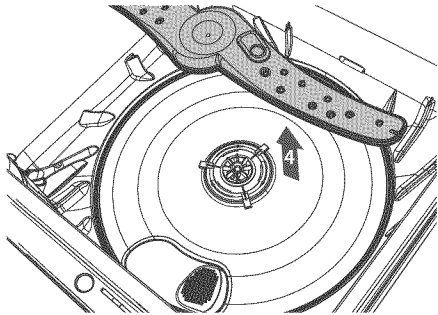
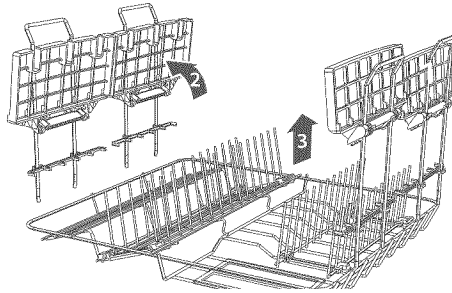

- 6 In the centre of the filter plate there are two rings. Turn the outer ring anticlockwise, about a 1/8 turn. This will release the filter plate.
- 7 Lift the filter plate out. Remove any foreign material, wash in hot soapy water and rinse thoroughly in clean water, then wipe with a damp cloth. Take care handling the sharp outer edge of the filter plate.

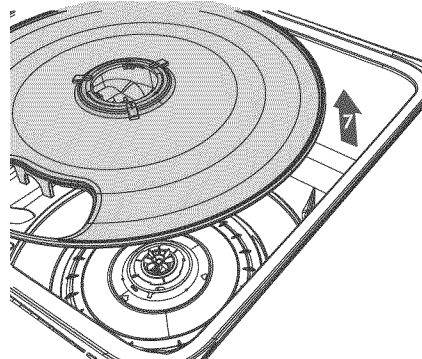
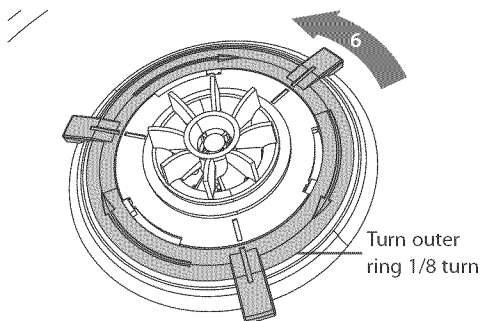

**To replace the filter plate and spray arm**

- 8 Before replacing the filter plate, ensure the O-ring is correctly positioned on the base, as shown.
- 9 Orientate the filter plate and lower it into place: make sure its kidney-shaped hole aligns with the matching recess in the dishwasher base.
- 10 Ensure the filter plate lies flat in the base, then lock it into position: turn the outer ring clockwise until the the marks align with each other and all three pin pairs firmly interlock, as shown.

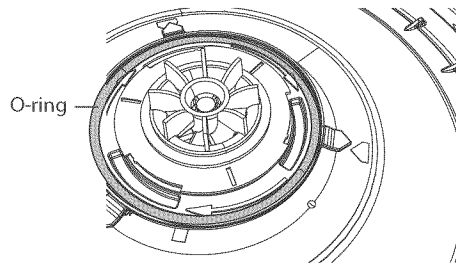

**Important!**

*The filter plate must not be able to move about freely.*

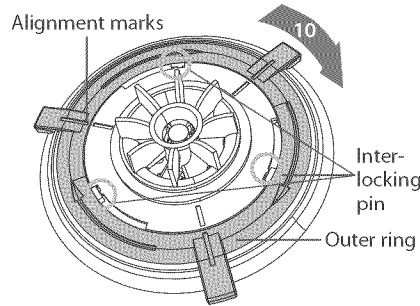
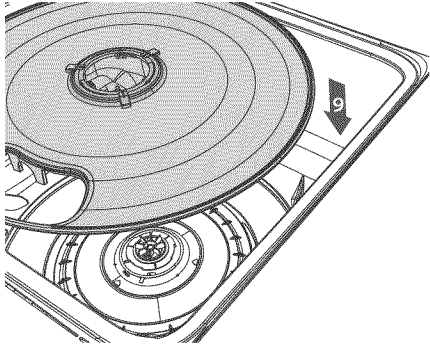

- 11 Replace the drain filter, ensuring it is flush with the filter plate.
- 12 Replace the spray arm back onto the impeller.

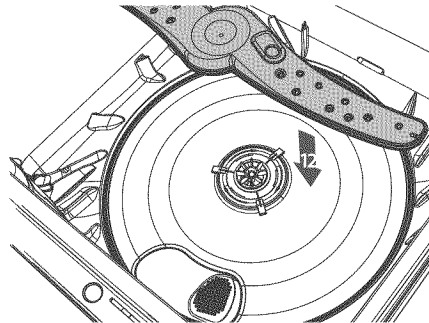
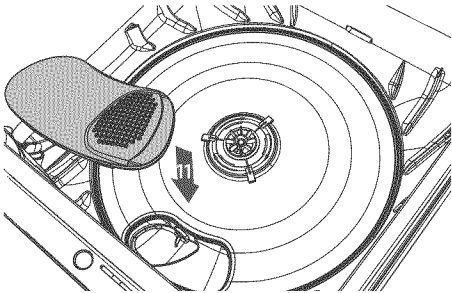

- 13 Replace the base rack, lowering its front edge into position first.
- 14 Plug the dishwasher back in or turn it on at the power supply.

Note: Where there is broken crockery or glass in the drawer, it must be carefully removed to prevent damage to the dishwasher.

### **Important!**

*Disconnect the dishwasher from the power supply (unplug or switch off at the circuit breaker) and allow all its parts to cool before any cleaning or maintenance.*

#### **Holiday time**

- If the dishwasher is not going to be used for some time, we recommend you leave it clean and empty. Leave the drawer ajar to allow air to circulate. Turn off both the power and water supply to the dishwasher.
- When using your dishwasher for the first time after a long period away, we recommend pouring 3 cups of water into the drawer before loading and starting a wash. This is to lubricate components that may have dried out during non-use.

#### **Cleaning the surfaces**

- 1 Wipe with a clean damp cloth. Take care not to wet the control panel.
- 2 Dry with a clean lint-free cloth.

### **Important!**

*We do not recommend the use of the following cleaning aids on your dishwasher as they may damage the surfaces:*

- *Plastic or stainless steel scouring pads*
- *Abrasive, solvent, household cleaners*
- *Acid or alkaline cleaners*
- *Hand washing liquids or soap*
- *Stainless steel cleaners or polishes*
- *Laundry detergents or disinfectants*

#### **Cleaning the drain filter, spray arm and filter plate**

- We recommend that the drain filter is cleaned whenever there is evidence of food particles.
- The spray arm may need cleaning about once a month in normal use or more often should the need arise.
- The filter plate should not normally need cleaning. Food particles remaining on its surface can be wiped off with a clean, damp cloth.

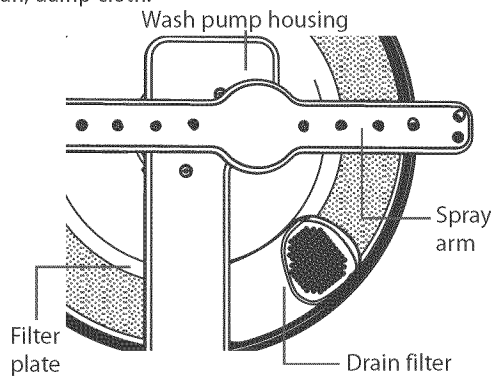

### ***Important!***

- *If a dishwasher cleaner/descaler is used, you must run a wash program with detergent immediately afterward to prevent any damage to your dishwasher.*
- *The dishwasher must be used with the filter plate, drain filter and spray arms correctly in place.*

#### **Cleaning the drain filter**

- 1 Unplug the dishwasher or turn it off at the power supply.
- 2 Ensure the tines above the drain filter are in the upright position.
- 3 Lift and remove the drain filter. It is normal to find some water under it.
- 4 Empty, rinse clean under running water and replace back into the allocated space.
- 5 Ensure the drain filter is flush with the filter plate.
- 6 Plug the dishwasher back in or turn it on at the power supply.

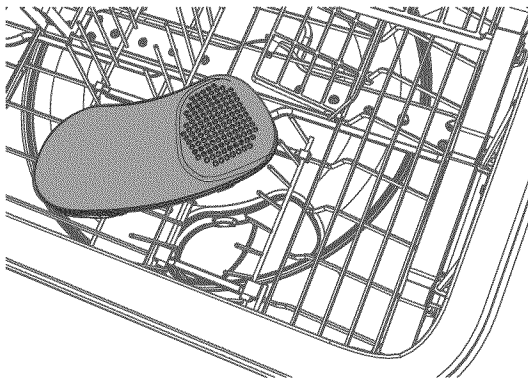
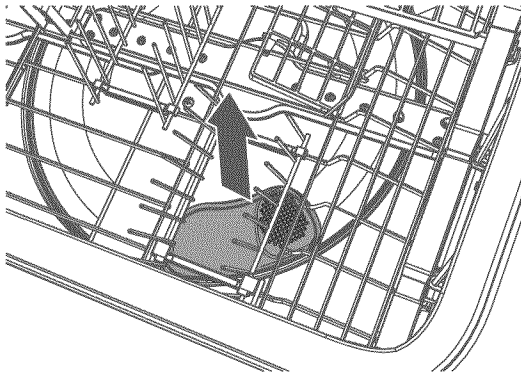

### Cleaning the spray arms and filter plate

Ensure the dishwasher is cool before you start cleaning.

#### *To remove the base rack and spray arms*

- 1 Unplug the dishwasher or turn it off at the power supply.
- 2 Take out the cutlery basket.
- 3 Unclip the glass supports (if fitted) from the rack wires and fold all the adjustable racks away, so that they are upright and close to the top.
- 4 Fold down all the tines.
- 5 Remove the base rack carefully. Start lifting from the back first, tilting the rack as needed to clear the adjustable racks and the dispenser in the front.
- 6 Unclip the spray arms off their mounting valves and shake any foreign material out.
- 7 Rinse the spray arm clean under running water and wipe with a damp cloth.
- 8 If necessary, wipe any soiling off the filter plate with a clean, damp cloth.

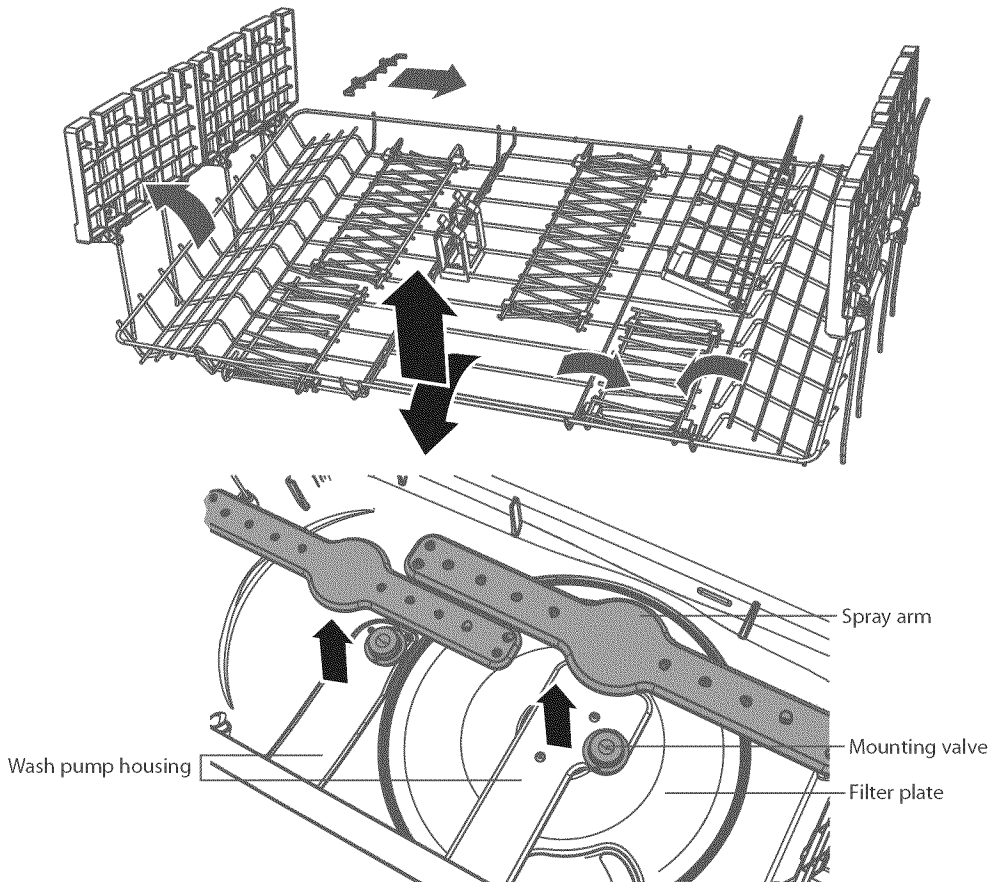











### *To replace the spray arms and base rack*

- 9 Clip the spray arms back onto their mounting valves. **Be careful that you don't force them too hard and apply too much pressure on the wash pump housing.** You should hear them click into place. Rotate them with your hand to check that they are located properly.
- 10 Replace the base rack, lowering its front edge into position first.
- 11 Clip the glass supports back on and arrange the racking back to your preference.
- 12 Plug the dishwasher back in or turn it on at the power supply.

Note: Where there is broken crockery or glass in the drawer, it must be carefully removed to prevent damage to the dishwasher.

Problem	Possible cause	What to do
<b>Unclean dishes</b>	Wash program unsuitable for the load.	See your 'Quick start guide' for a suitable wash program, or the soils were too heavily baked on and dishes may need soaking.
	Spray arm unable to rotate.	Ensure no items are obstructing the spray arm path.
	Drawer overloaded/incorrectly loaded.	Refer to the section on loading.
	Filter plate/drain filter is incorrectly inserted.	See section 'User maintenance instructions'.
	Detergent put in the wrong compartment of the dispenser.	Detergent must be placed in the large compartment. See section 'Adding detergent' for information.
	Excess food not removed from dinnerware prior to loading.	Scrape all food scraps off dinnerware prior to loading.
	Unsuitable detergent.	Use detergents suitable for automatic dishwashers. See section 'Adding detergent' for examples of suitable and unsuitable detergents.
	Not enough detergent.	See section 'Wash programs and detergent quantities' or follow the detergent manufacturer's instructions.
	Spray arm holes are blocked.	Clean the spray arm.
<b>Foaming</b>	Filter plate/drain filter is blocked.	Clean the filter plate and drain filter.
	Incorrect amount of detergent.	See section 'Wash programs and detergent quantities' or follow the detergent manufacturer's instructions.
	Too much egg in the wash load.	Increase the amount of detergent.
	Rinse aid setting too high.	Decrease the rinse aid setting.
<b>Water leaking</b>	Rinse aid dispenser plug not closed properly.	Ensure that the rinse aid dispenser plug is closed tight, with its hand grip pointing straight ahead. See section 'Using rinse aid'.
	Drain hose disconnected from waste pipe.	Reconnect the drain hose to the waste pipe.
	Water inlet hose not properly connected.	Ensure the inlet hose is connected securely.
	Other leaks.	Turn water and power supplies to the dishwasher off. Call Customer Care or your Authorised Service Centre. See your 'Service and warranty' booklet for contact details.
	Rinse aid dispenser plug not closed properly.	Ensure that the rinse aid dispenser plug is closed tight, with its hand grip pointing straight ahead. See section 'Using rinse aid'.

Problem	Possible cause	What to do
Drawer will not open (no beeping, no wash underway)	Childlock feature is on or the 'Closed drawer autolock' option is on, or both.	Turn the Childlock off. Hold down the  button until the  symbol disappears from the display or the light above the  button goes out and/or press the  /  button to open the drawer.
Power failure during cycle	Power outage in your home or area.	Wait until power resumes, cycle will restart in same part of wash program.
Continuous beeping	A fault has occurred.	Refer to section 'If there is a fault'.
Intermittent beeping	Dishwasher is in pause mode.	Close the dishwasher and press the  button to resume the program.
High-pitched, subtle beeping during a wash program	Rinse aid is being dispensed.	This is normal and needs no action.
Control buttons inside the drawer do not respond to touch	Water over control buttons.	Wipe the area dry.
Dishwasher will not start	Power supply is not connected.	Connect the power supply.
	The drawer is not closed properly.	Ensure the drawer is firmly closed.
	<i>Models with three buttons on the front only:</i> Keylock or Childlock feature is on.	Turn the Keylock or Childlock off. Hold down the  button until the  symbol disappears from the display or the light above the  button goes out.
	 button not pressed.	Press the  button.
Fan noise coming from the dishwasher after a wash program has finished	This is normal. The drying fan continues to run for a set period of time after a program has finished to assist with drying.	No action required. The fan will automatically stop after the set time is over, or when the drawer is opened. In some cases, the fan may resume when the drawer is closed again.
Fan noise starts up when I close the drawer, even though I didn't start a new wash	This is normal. In some cases, the drying fan will run whenever the drawer is closed for a set period of time after a program has finished.	No action required. The fan will automatically stop after the set time is over.

Problem	Possible Cause	What to do
The wash program seems to have finished (the dishwasher is idle), but the end of wash beeps haven't sounded and the drawer cannot be opened	The wash program is still underway. It is in a 'quiet' phase that is needed for ensuring the best wash results.	No action required. The program will transition into a more audible phase after the 'quiet' phase is over.
Water pooling on inner rim of drawer after a wash	This is normal condensation.	If there is any water over the control buttons, wipe dry.
Water under the drain filter	This is normal and needs no action.	
Excess water in the drawer	Drain hose(s) bent or kinked.	Straighten the drain hose(s).
	Blocked filters.	Clean the filter plate/drain filter. Refer to 'User maintenance instructions'.
Water marks on the dishes	Rinse aid depleted.	Refill the rinse aid dispenser.
	Rinse aid setting too low.	Increase the rinse aid setting.
	Dishwasher overloaded/incorrectly loaded.	Refer to the section on loading.
Drawer interior is stained	Some foods, like tomato based products, may stain the inside of the drawer.	Pre-rinse dishes before placing in the drawer. Alternatively, using the Rinse program after adding the dishes may minimise staining.
Dishes did not dry	Incorrect loading.	Ensure the dishes are not nesting together.
	Dishes were left in the drawer for several hours after a wash.	We recommend unloading the dishes within a few hours after a wash program has finished, as the small amount of vapour left after the wash may -with time- resettle on dishes as condensation. Using rinse aid or increasing its setting may also help reduce this problem.
	Rinse aid depleted.	Refill the rinse aid dispenser.
	Rinse aid setting too low.	Increase the rinse aid setting.
	Eco wash program used.	Choose a standard wash program.
No detergent dispensed	Detergent dispenser was wet when loaded.	Clean the dispenser and ensure it is dry before adding detergent.
Excessive motor noise	The filter plate and/or spray arm is incorrectly placed.	Refer to the 'User maintenance instructions' section for details on correct placement.
	No water in the motor area.	This usually occurs on the first use or when the dishwasher has not been used for long periods of time. Pour 3 cups of water into the drawer before running a wash program.

### How do I know if there is a fault?

Your dishwasher will self-diagnose and let you know by beeping continuously and showing a fault code on the wash program panel inside the drawer (all models) and in the display (Classic models only) .

### What should I do if there is a fault?

Check what kind of model you have and attend to the fault by following the appropriate flowchart following. You may be able to fix some of the faults yourself – with others, you will need to contact Fisher & Paykel Customer Care to organise a visit by a service technician.

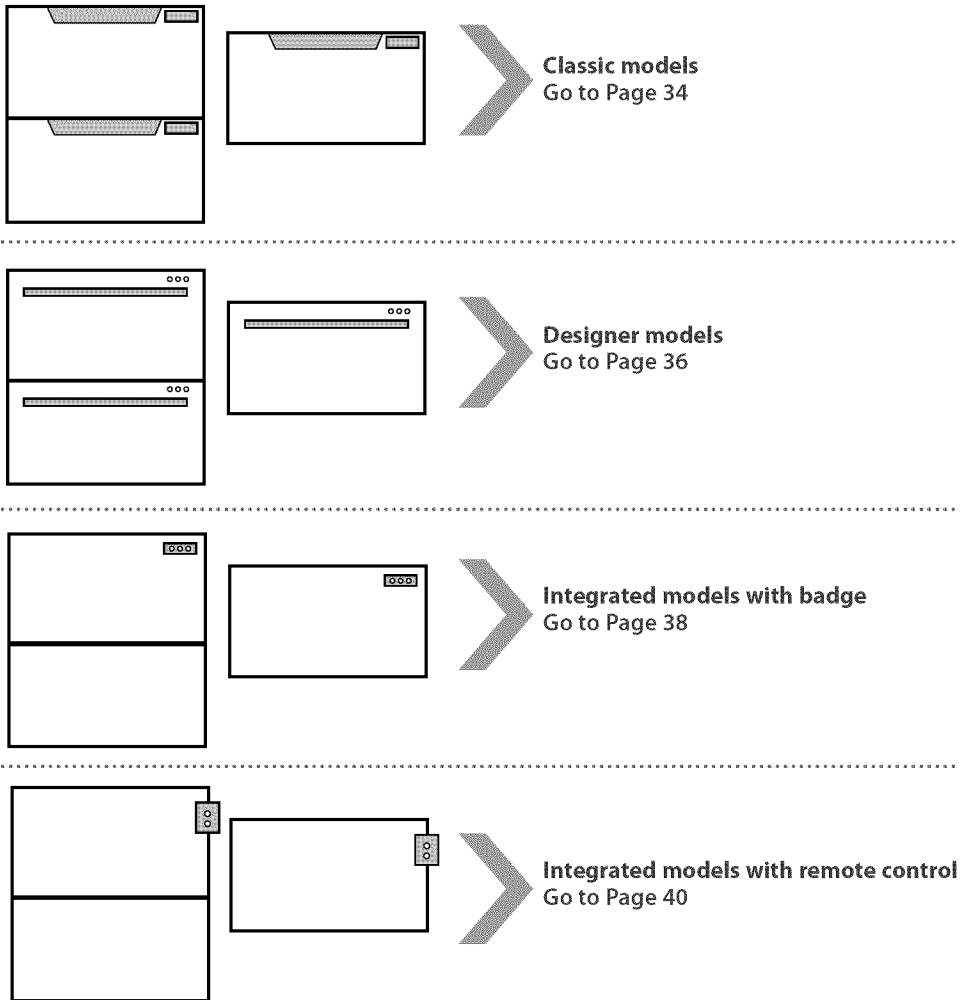

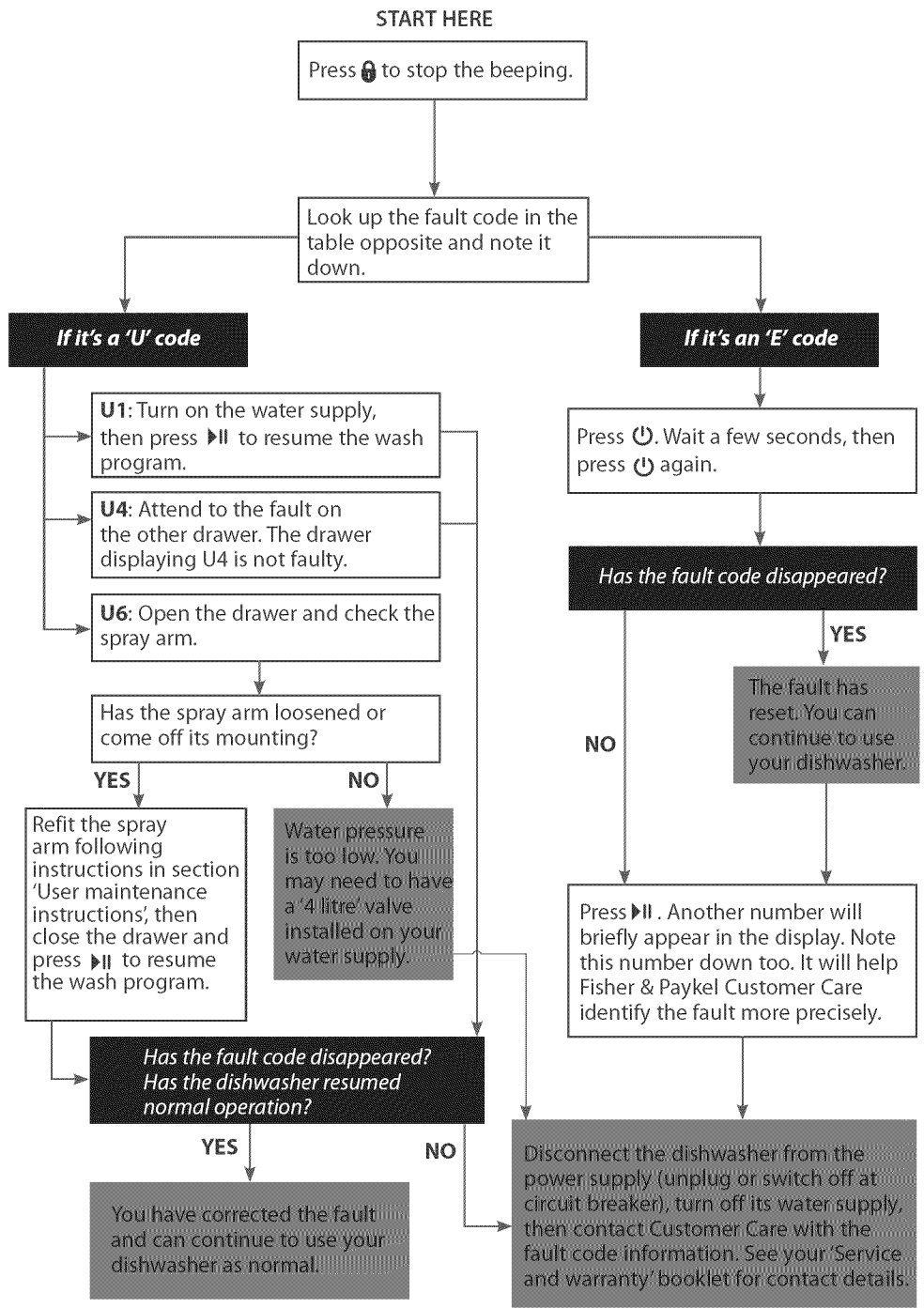

Display	Fault Code	Possible cause of fault
U1 <sup>⊗</sup>	U1	No water – the water supply hasn't been turned on.
U4	U4	Fault in the <i>other</i> drawer preventing the use of this drawer.
U6	U6	The spray arm has loosened or come off its mounting, or water pressure is too low.

Display	Fault Code	Possible cause of fault
E1 <sup>^</sup>	E1	Flood detected.
E2 <sup>^</sup>	E2	Motor fault.
E3 <sup>^</sup>	E3	Temperature sensor fault. You may need to have a tempering valve installed on your water supply, to ensure that incoming water is less than 65°C (149°F).
E4 <sup>^</sup>	E4	Heating element failed.
E5 <sup>^</sup>	E5	Fault with the internal lid of the dishwasher.
E6 <sup>^</sup>	E6	Fault with the drying fan.
E7 <sup>^</sup>	E7	Electronics fault—detergent dispensing system.
E8 <sup>^</sup>	E8	Electronics fault—other systems.
E9 <sup>^</sup>	E9	Electronics fault—controller.
EC <sup>^</sup>	EC	Electronics fault—communication between drawers.

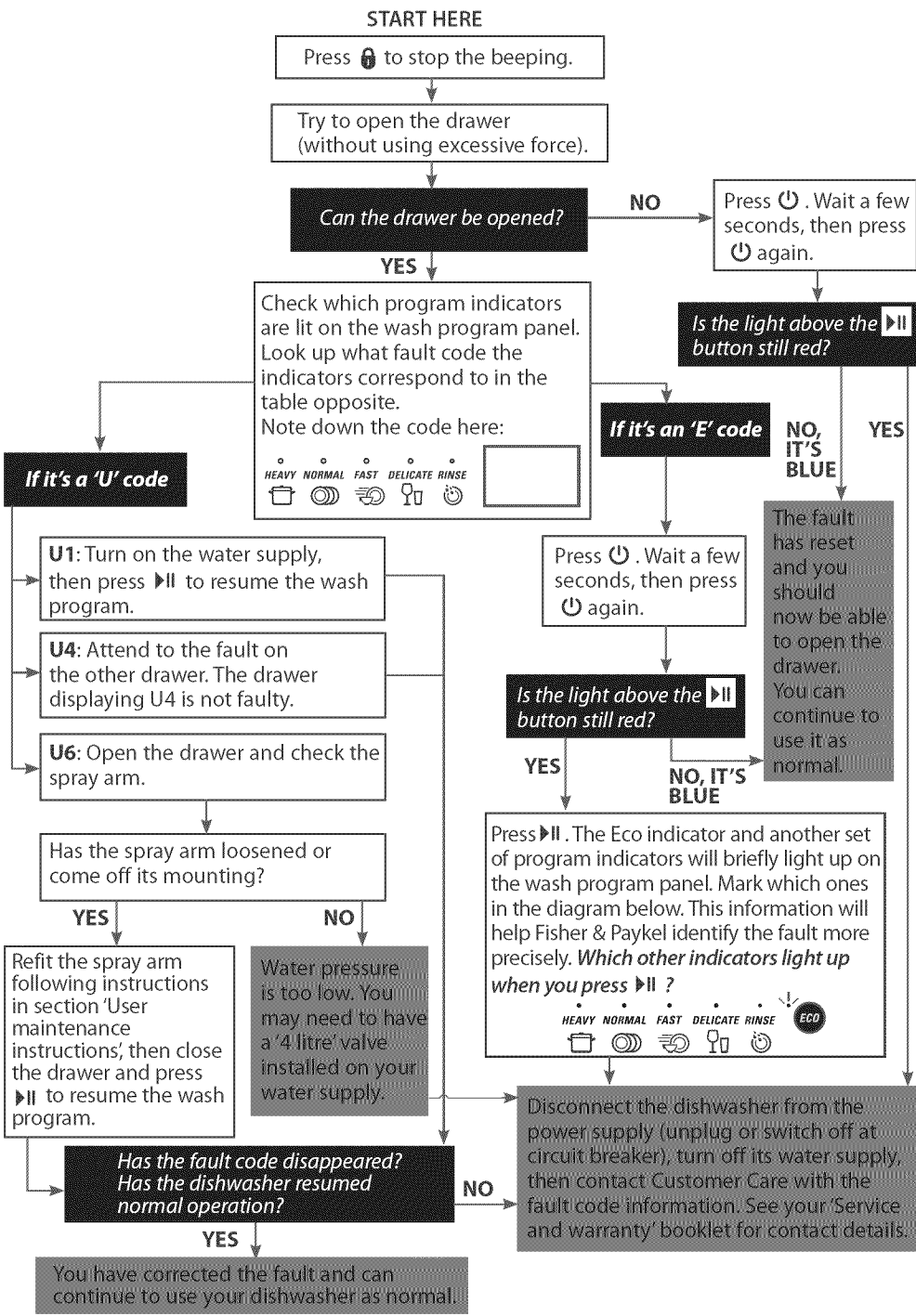

Wash program panel	Fault Code	Possible cause of fault
	U1	No water – the water supply hasn't been turned on.
	U4	Fault in the <i>other</i> drawer preventing the use of this drawer.
	U6	The spray arm has loosened or come off its mounting, or water pressure is too low.

Wash program panel	Fault Code	Possible cause of fault
	E1	Flood detected.
	E2	Motor fault.
	E3	Temperature sensor fault. You may need to have a tempering valve installed on your water supply, to ensure that incoming water is less than 65°C (149°F).
	E4	Heating element failed.
	E5	Fault with the internal lid of the dishwasher.
	E6	Fault with the drying fan.
	E7	Electronics fault—detergent dispensing system.
	E8	Electronics fault—other systems.
	E9	Electronics fault—controller.
	EC	Electronics fault—communication between drawers.

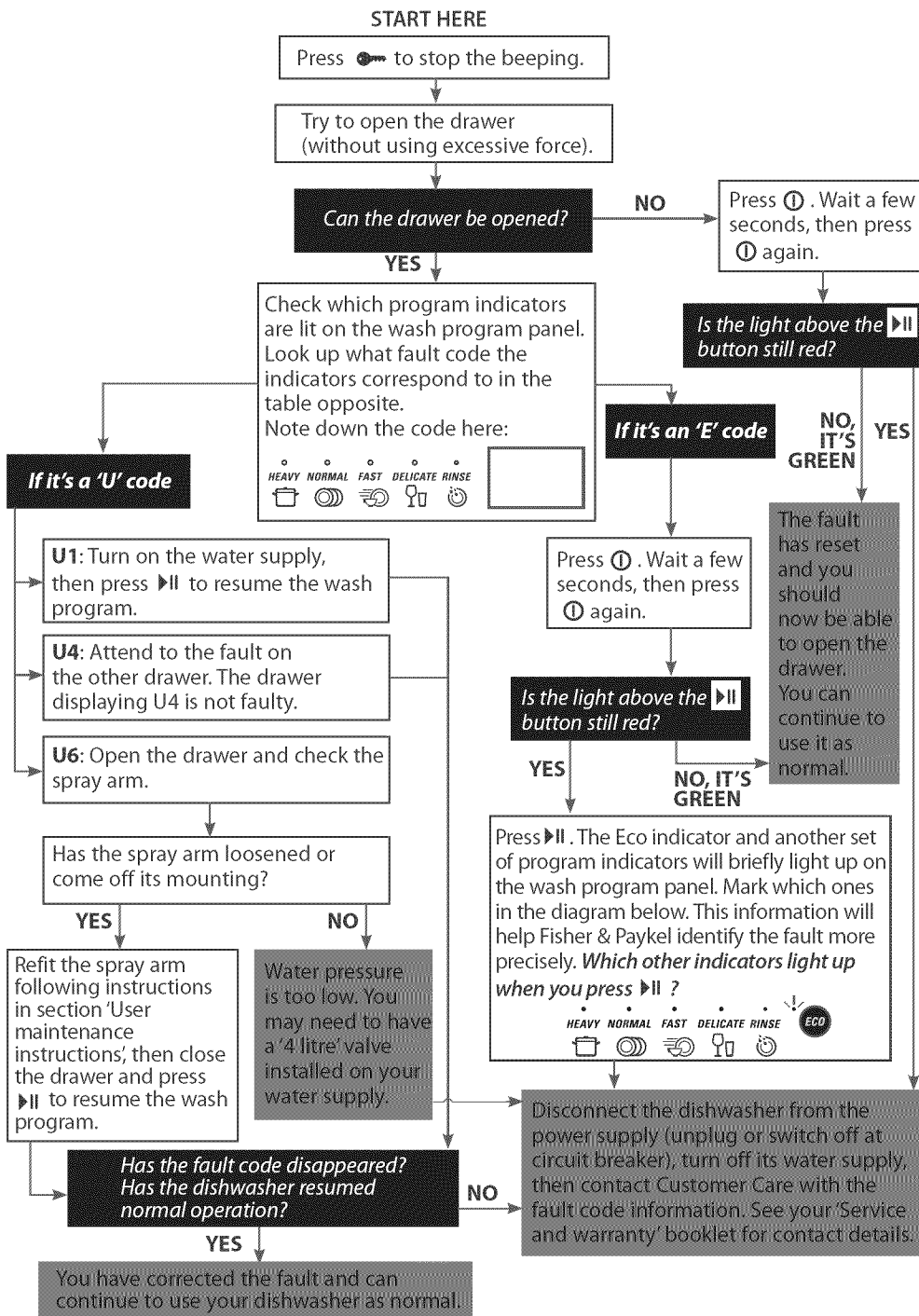

Wash program panel	Fault Code	Possible cause of fault
	U1	No water – the water supply hasn't been turned on.
	U4	Fault in the <i>other</i> drawer preventing the use of this drawer.
	U6	The spray arm has loosened or come off its mounting, or water pressure is too low.

Wash program panel	Fault Code	Possible cause of fault
	E1	Flood detected.
	E2	Motor fault.
	E3	Temperature sensor fault. You may need to have a tempering valve installed on your water supply, to ensure that incoming water is less than 65°C (149°F).
	E4	Heating element failed.
	E5	Fault with the internal lid of the dishwasher.
	E6	Fault with the drying fan.
	E7	Electronics fault—detergent dispensing system.
	E8	Electronics fault—other systems.
	E9	Electronics fault—controller.
	EC	Electronics fault—communication between drawers.

40 How to attend to a fault - Integrated models with remote control

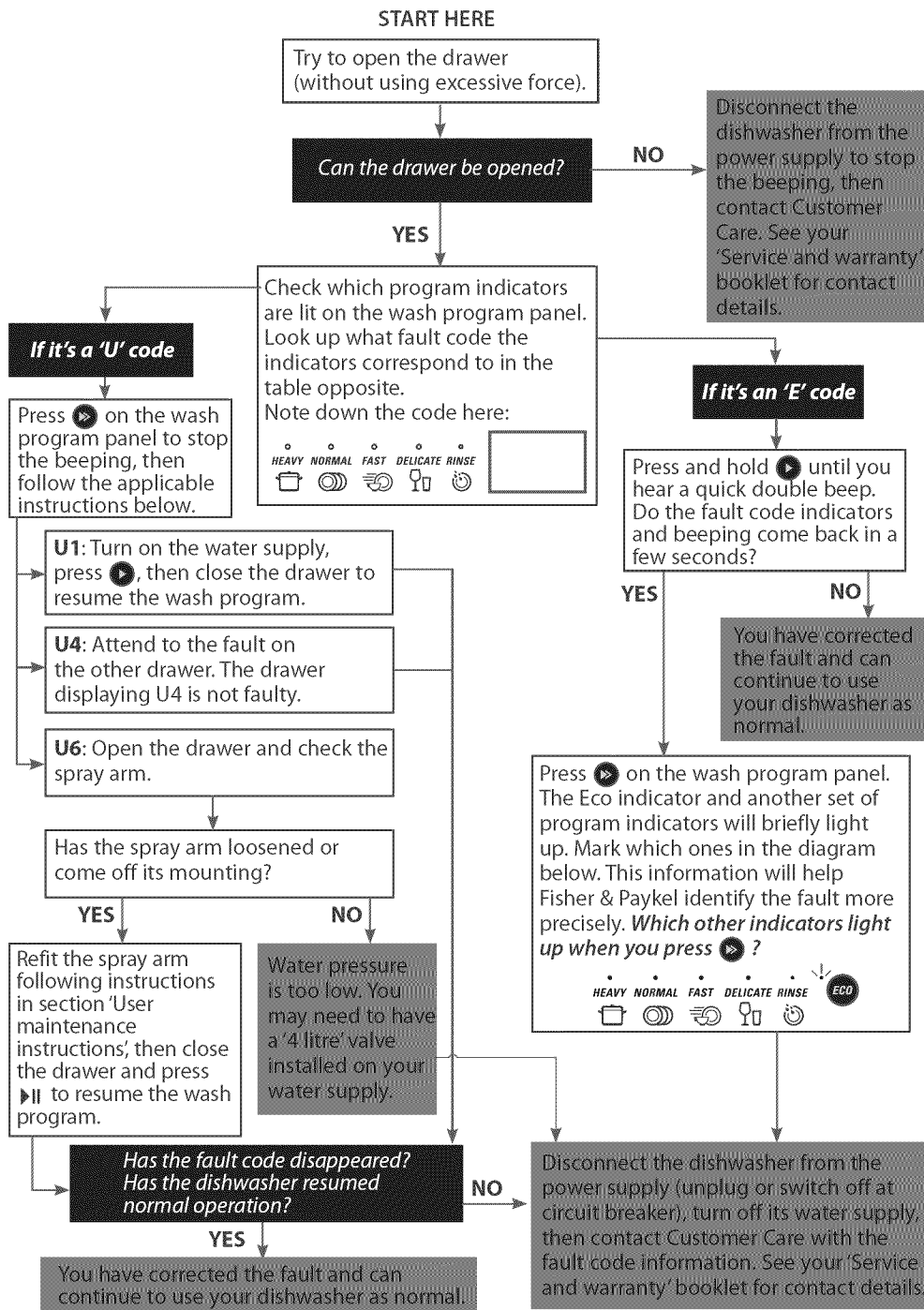

## Integrated models with remote control

Wash program panel	Fault Code	Possible cause of fault
	U1	No water – the water supply hasn't been turned on.
	U4	Fault in the <i>other</i> drawer preventing the use of this drawer.
	U6	The spray arm has loosened or come off its mounting, or water pressure is too low.

Wash program panel	Fault Code	Possible cause of fault
	E1	Flood detected.
	E2	Motor fault.
	E3	Temperature sensor fault. You may need to have a tempering valve installed on your water supply, to ensure that incoming water is less than 65°C (149°F).
	E4	Heating element failed.
	E5	Fault with the internal lid of the dishwasher.
	E6	Fault with the drying fan.
	E7	Electronics fault—detergent dispensing system.
	E8	Electronics fault—other systems.
	E9	Electronics fault—controller.
	EC	Electronics fault—communication between drawers.

**Before you call for service or assistance ...**

Check the things you can do yourself. Refer to the 'Installation instructions', 'User guide' and 'Quick start guide' and check that:

- 1 your product is correctly installed
- 2 you are familiar with its normal operation.

If after checking these points you still need assistance, please see your 'Service and warranty' booklet for warranty information and Customer Care contact details, or contact us through our website listed on the back cover.

.....  
**Fisher & Paykel Appliances**

**Model no.** ..... **Serial no.** .....

*Copy this from the serial label of your dishwasher.  
The label is located inside cabinet, underneath the  
(top) drawer.*

**Date of purchase** .....

**Contact details** ..... **Dealer name** .....

.....



## 44 Wash program data - DD24/DD60 models

For information on which program to use for your load, see your 'Quick start guide'.  
Wash cycle times indicated are approximate.

USA & CANADA - Classic, Designer, and Integrated double models				
HEAVY (~127 mins)	NORMAL (~128 mins)	FAST (~53 mins)	DELICATE (~82 mins)	RINSE (~11 mins)
pre-wash 120°F			pre-wash	
main wash 150°F	main wash 130°F	main wash 130°F	main wash 120°F	
post-rinse x3	post-rinse	post-rinse	post-rinse x2	
final rinse 163°F	final rinse 130°F	final rinse 120°F	final rinse 130°F	
drying phase	drying phase		drying phase	
HEAVY ECO (~107 mins)	NORMAL ECO (~100 mins)	FAST ECO (~35 mins)	DELICATE ECO (~68 mins)	
main wash 150°F	main wash 120°F	main wash 115°F	main wash 115°F	
post-rinse x3	post-rinse	post-rinse	post-rinse x2	
final rinse 150°F	final rinse 125°F	final rinse 115°F	final rinse 120°F	
drying phase	drying phase		drying phase	

USA & CANADA - Integrated single models				
HEAVY (~163 mins)	NORMAL (~164 mins)	FAST (~82 mins)	DELICATE (~118 mins)	RINSE (~11 mins)
pre-wash 120°F			pre-wash	
main wash 150°F	main wash 130°F	main wash 130°F	main wash 120°F	
post-rinse x3	post-rinse	post-rinse	post-rinse x2	
final rinse 135°F	final rinse 130°F	final rinse 120°F	final rinse 130°F	
drying phase	drying phase	drying phase	drying phase	
HEAVY ECO (~158 mins)	NORMAL ECO (~133 mins)	FAST ECO (~62 mins)	DELICATE ECO (~99 mins)	
main wash 150°F	main wash 120°F	main wash 115°F	main wash 115°F	
post-rinse x3	post-rinse	post-rinse	post-rinse x2	
final rinse 135°F	final rinse 125°F	final rinse 115°F	final rinse 120°F	
drying phase	drying phase	drying phase	drying phase	

**NEW ZEALAND & AUSTRALIA - Classic, Designer, and Integrated double models**

HEAVY (~124 mins)	NORMAL (~128 mins)	FAST (~49 mins)	DELICATE (~92 mins)	RINSE (~11 mins)
----------------------	-----------------------	--------------------	------------------------	---------------------

pre-wash

main wash 70°C	main wash 60°C	main wash 55°C	main wash 50°C
post-rinse x2	post-rinse	post-rinse	post-rinse x2
final rinse 65°C	final rinse 60°C	final rinse 55°C	final rinse 60°C
drying phase	drying phase		drying phase

HEAVY ECO (~120 mins)	NORMAL ECO* (~149 mins)	FAST ECO (~33 mins)	DELICATE ECO (~80 mins)
--------------------------	----------------------------	------------------------	----------------------------

main wash 65°C	main wash 40°C	main wash 45°C	main wash 45°C
post-rinse x2	post-rinse	post-rinse	post-rinse x2
final rinse 55°C	final rinse 40°C	final rinse 45°C	final rinse 50°C
drying phase	drying phase		drying phase

**NEW ZEALAND & AUSTRALIA - Integrated single models**

HEAVY (~170 mins)	NORMAL (~174 mins)	FAST (~83 mins)	DELICATE (~128 mins)	RINSE (~11 mins)
----------------------	-----------------------	--------------------	-------------------------	---------------------

pre-wash

main wash 70°C	main wash 60°C	main wash 55°C	main wash 50°C
post-rinse x2	post-rinse	post-rinse	post-rinse x2
final rinse 57°C	final rinse 57°C	final rinse 55°C	final rinse 57°C
drying phase	drying phase	drying phase	drying phase

HEAVY ECO (~166 mins)	NORMAL ECO* (~189 mins)	FAST ECO (~60 mins)	DELICATE ECO (~111 mins)
--------------------------	----------------------------	------------------------	-----------------------------

main wash 65°C	main wash 40°C	main wash 45°C	main wash 45°C
post-rinse x2	post-rinse	post-rinse	post-rinse x2
final rinse 55°C	final rinse 40°C	final rinse 45°C	final rinse 50°C
drying phase	drying phase	drying phase	drying phase

\*Reference program for energy label in compliance with AS/NZS 2007.

46 Wash program data - DD24/DD60 models

GREAT BRITAIN AND IRELAND				
HEAVY (~126 mins)	NORMAL (~95 mins)	FAST (~53 mins)	DELICATE (~92 mins)	RINSE (~11 mins)
				pre-wash
main wash 70°C	main wash 65°C	main wash 55°C	main wash 50°C	
post-rinse x2	post-rinse x2	post-rinse	post-rinse x2	
final rinse 65°C	final rinse 65°C	final rinse 50°C	final rinse 60°C	
drying phase	drying phase		drying phase	
HEAVY ECO (~121 mins)	NORMAL ECO* (~159 mins)	FAST ECO (~39 mins)	DELICATE ECO (~87 mins)	
main wash 60°C	main wash 50°C	main wash 45°C	main wash 45°C	
post-rinse x2	post-rinse	post-rinse	post-rinse x2	
final rinse 55°C	final rinse 60°C	final rinse 45°C	final rinse 50°C	
drying phase	drying phase		drying phase	

\*Reference program for energy label in compliance with EN50242 Regulations.

**Note:**

Wash times can vary depending on the incoming water temperature, ambient conditions, type of dish load and whether the drawer has been opened during the wash. Wash times are only APPROXIMATE on the electronic display and based on 120°F (USA and Canada), 20°C (New Zealand and Australia), or 15°C (Great Britain and Ireland) incoming water.



## 48 Wash program data - DD36/DD90 models

For information on which program to use for your load, see your 'Quick start guide'.  
Wash cycle times indicated are approximate.

USA & CANADA - Designer models				
HEAVY (~141 mins)	NORMAL (~148 mins)	FAST (~58 mins)	DELICATE (~85 mins)	RINSE (~9 mins)
pre-wash 120°F			pre-wash	
main wash 150°F	main wash 140°F	main wash 130°F	main wash 120°F	
post-rinse x3	post-rinse x3	post-rinse	post-rinse x2	
final rinse 163°F	final rinse 150°F	final rinse 140°F	final rinse 130°F	
drying phase	drying phase		drying phase	
HEAVY ECO (~135 mins)	NORMAL ECO (~113 mins)	FAST ECO (~39 mins)	DELICATE ECO (~60 mins)	
pre-wash				
main wash 140°F	main wash 120°F	main wash 115°F	main wash 115°F	
post-rinse x3	post-rinse	post-rinse	post-rinse x2	
final rinse 150°F	final rinse 150°F	final rinse 115°F	final rinse 120°F	
drying phase	drying phase		drying phase	

USA & CANADA - Integrated models				
HEAVY (~179 mins)	NORMAL (~186 mins)	FAST (~94 mins)	DELICATE (~122 mins)	RINSE (~9 mins)
pre-wash 120°F			pre-wash	
main wash 150°F	main wash 140°F	main wash 130°F	main wash 120°F	
post-rinse x3	post-rinse x3	post-rinse	post-rinse x2	
final rinse 135°F	final rinse 135°F	final rinse 135°F	final rinse 130°F	
drying phase	drying phase	drying phase	drying phase	
HEAVY ECO (~173 mins)	NORMAL ECO (~151 mins)	FAST ECO (~72 mins)	DELICATE ECO (~95 mins)	
pre-wash				
main wash 140°F	main wash 120°F	main wash 115°F	main wash 115°F	
post-rinse x3	post-rinse	post-rinse	post-rinse x2	
final rinse 135°F	final rinse 135°F	final rinse 115°F	final rinse 120°F	
drying phase	drying phase	drying phase	drying phase	

NEW ZEALAND & AUSTRALIA - Designer models				
HEAVY (~130 mins)	NORMAL (~120 mins)	FAST (~55 mins)	DELICATE (~98 mins)	RINSE (~11 mins)
pre-wash				
main wash 70°C	main wash 50°C	main wash 55°C	main wash 50°C	
post-rinse x2	post-rinse	post-rinse	post-rinse x2	
final rinse 65°C	final rinse 60°C	final rinse 60°C	final rinse 60°C	
drying phase	drying phase		drying phase	
HEAVY ECO (~129 mins)	NORMAL ECO* (~146 mins)	FAST ECO (~45 mins)	DELICATE ECO (~91 mins)	
main wash 60°C	main wash 42°C	main wash 45°C	main wash 45°C	
post-rinse x2	post-rinse	post-rinse	post-rinse x2	
final rinse 55°C	final rinse 43°C	final rinse 45°C	final rinse 50°C	
drying phase	drying phase		drying phase	

NEW ZEALAND & AUSTRALIA - Integrated models				
HEAVY (~168 mins)	NORMAL (~158 mins)	FAST (~91 mins)	DELICATE (~136 mins)	RINSE (~11 mins)
pre-wash				
main wash 70°C	main wash 50°C	main wash 55°C	main wash 50°C	
post-rinse x2	post-rinse	post-rinse	post-rinse x2	
final rinse 57°C	final rinse 57°C	final rinse 57°C	final rinse 57°C	
drying phase	drying phase	drying phase	drying phase	
HEAVY ECO (~166 mins)	NORMAL ECO* (~177 mins)	FAST ECO (~78 mins)	DELICATE ECO (~126 mins)	
main wash 60°C	main wash 42°C	main wash 45°C	main wash 45°C	
post-rinse x2	post-rinse	post-rinse	post-rinse x2	
final rinse 55°C	final rinse 43°C	final rinse 45°C	final rinse 50°C	
drying phase	drying phase	drying phase	drying phase	

\*Reference program for energy label in compliance with AS/NZS 2007.

50 Wash program data - DD36/DD90 models

GREAT BRITAIN AND IRELAND				
HEAVY (~126 mins)	NORMAL (~95 mins)	FAST (~60 mins)	DELICATE (~99 mins)	RINSE (~11 mins)
				pre-wash
main wash 70°C	main wash 65°C	main wash 55°C	main wash 50°C	
post-rinse x2	post-rinse x2	post-rinse	post-rinse x2	
final rinse 65°C	final rinse 65°C	final rinse 60°C	final rinse 60°C	
drying phase	drying phase		drying phase	
HEAVY ECO (~121 mins)	NORMAL ECO* (~179 mins)	FAST ECO (~42 mins)	DELICATE ECO (~92 mins)	
main wash 60°C	main wash 50°C	main wash 45°C	main wash 45°C	
post-rinse x2	post-rinse	post-rinse	post-rinse x2	
final rinse 55°C	final rinse 55°C	final rinse 45°C	final rinse 50°C	
drying phase	drying phase		drying phase	

\*Reference program for energy label in compliance with EN50242 Regulations.

**Note:**

Wash times can vary depending on the incoming water temperature, ambient conditions, type of dish load and whether the drawer has been opened during the wash. Wash times are only APPROXIMATE on the electronic display and based on 120°F (USA and Canada), 20°C (New Zealand and Australia), or 15°C (Great Britain and Ireland) incoming water.



**52 Standards test - DD24 models (USA & CANADA)**

The dishwashers are tested to various standards for wash performance using the parameters detailed below.

<b>Wash program</b>	Normal Eco (At the end of the program, open the drawer 2" (50 mm) to improve the dry performance.)
<b>Rinse agent setting</b>	4
<b>Maximum place setting</b>	10 for double models
<b>Water softener setting</b> (for DD24-H models only)	Adjust the water softener to match the water hardness. Refer to the 'Water softener' section.

**Height setting of adjustable rack.**

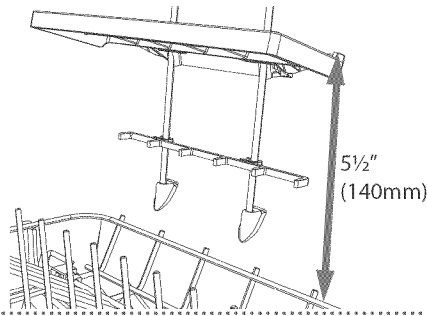

**Recommended loading pattern**

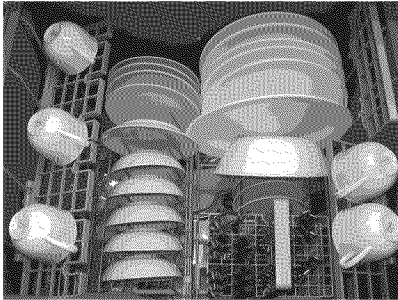

Top drawer

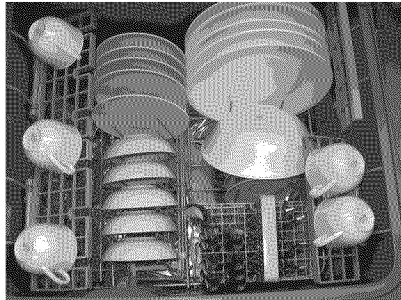

Bottom drawer

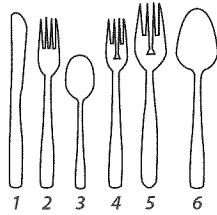
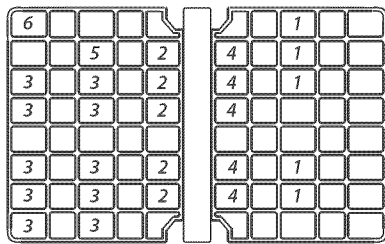

Cutlery basket

The dishwashers are tested to various standards for wash performance using the parameters detailed below.

<b>Wash program</b>	Normal Eco (At the end of the program, open the drawer 2" (50 mm) to improve the dry performance.)
.....	
<b>Rinse agent setting</b>	4
.....	
<b>Maximum place setting</b>	9
.....	
<b>Accessories to be used in the dishwasher standards test</b>	Base rack, folding tines, cutlery basket with cutlery grid, adjustable racks, glass supports, multi-purpose clip. Use the multi-purpose clip to hold the platter
.....	
<b>Recommended loading pattern</b>	

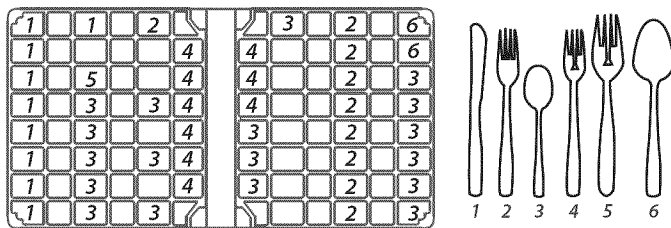
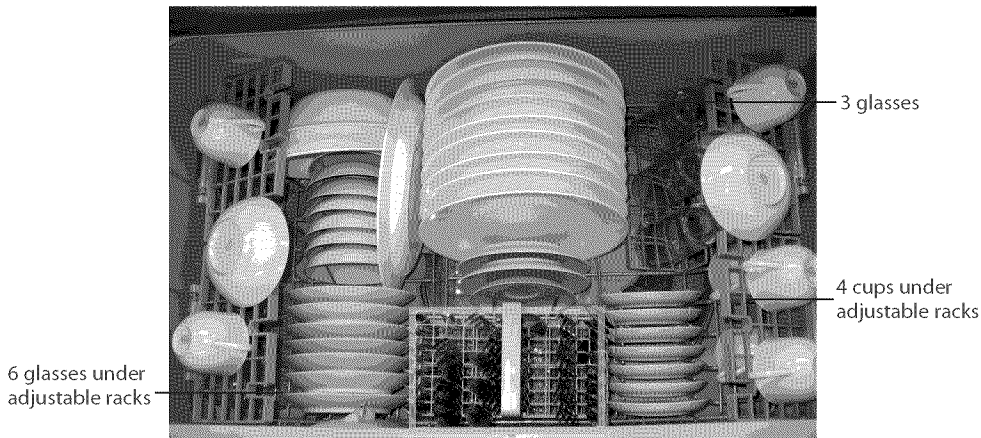

Cutlery basket

54 Standards test - DD60 models (NZ & AUSTRALIA)

The dishwashers are tested to AS/NZS 2007 standards for both wash and dry performance, using the parameters detailed below.

Wash program	Normal Eco (At the end of the program, open the drawer 50 mm to improve the dry performance.)
Detergent quantities	23.75g (main wash) per drawer
Rinse aid setting	4
Maximum place setting (per drawer)	7
Accessories to be used in the Dishwasher standards test	Base rack, folding tines, spacing-adjustable tines, cutlery basket with cutlery grid, adjustable racks, glass supports.

Height setting of adjustable racks

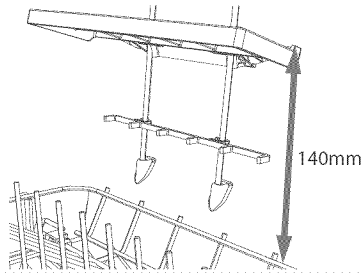

Correct orientation of glass supports on both sides of drawer

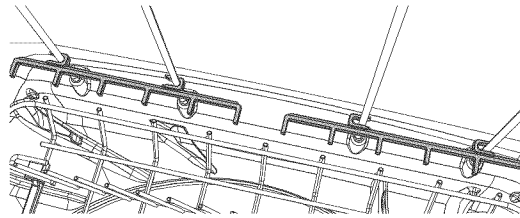

Recommended loading pattern

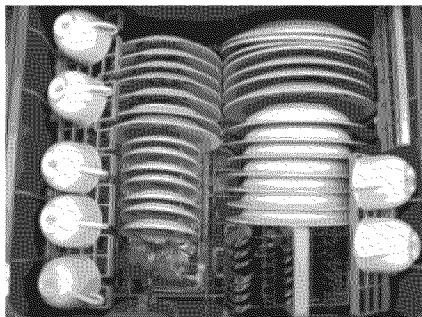

Top and Bottom drawer

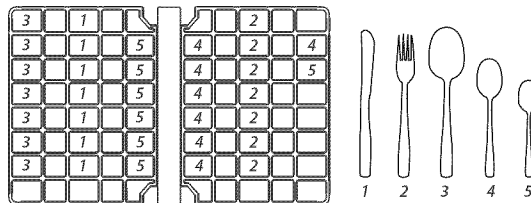

Cutlery basket

The dishwashers are tested to AS/NZS 2007 standards for both wash and dry performance using the parameters detailed below.

Wash programme	Normal Eco (At the end of the programme, open the drawer 50 mm to improve the dry performance.)
Detergent quantities	26.25g (main wash)
Rinse aid setting	4
Maximum place setting	9
Accessories to be used in the dishwasher standards test	Base rack, folding tines, cutlery basket with cutlery grid, adjustable racks, glass supports, multi-purpose clip.
Height setting of adjustable racks	

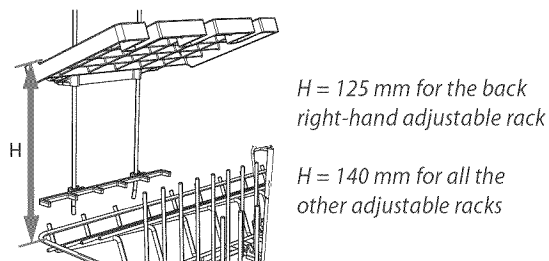

Correct orientation of glass supports on both sides of drawer

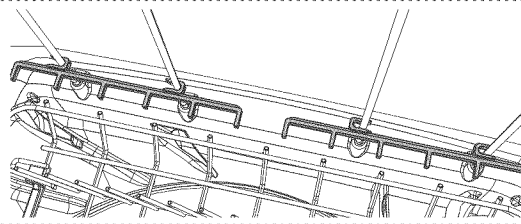

Recommended loading pattern

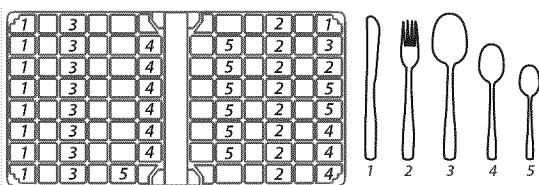
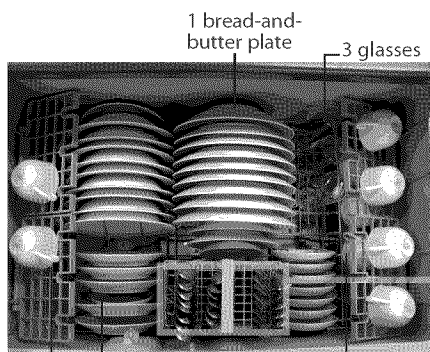

3 cups + 1 glass under adjustable racks

56 Standards test - DD60 models (GREAT BRITAIN & IRELAND)

The dishwashers are tested to EN50242 standards for both wash and dry performances using the parameters detailed below.

Wash program	Normal Eco
Detergent quantities	2.5g (pre-wash) per drawer 15.5g (main wash) per drawer
Rinse aid setting	4
Water softener setting	Adjust the water softener to match the water hardness. Refer to the 'Water softener' and 'Option adjustments' sections.
Maximum place setting (per drawer)	6
Accessories to be used in the Dishwasher standards test	Base rack, folding tines, spacing-adjustable tines, cutlery basket, adjustable racks, glass supports.
Height setting of adjustable racks	

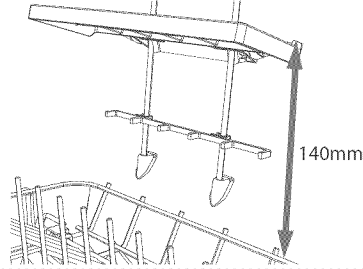

Correct orientation of glass supports on both sides of drawer

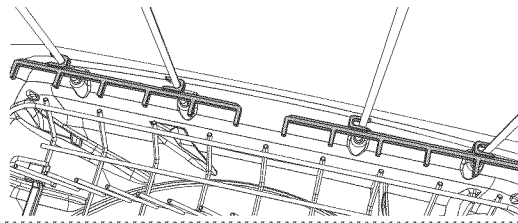

Recommended loading pattern

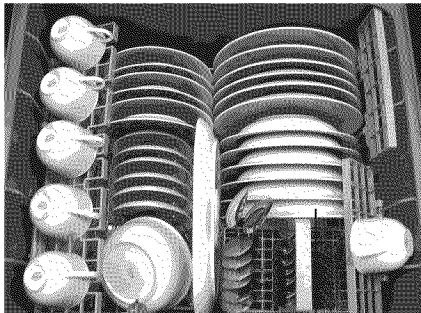

Top and Bottom drawer

small bowl between cutlery basket and first soup bowl

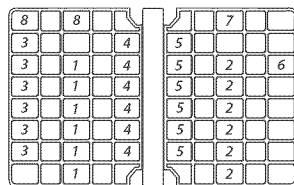

Cutlery basket

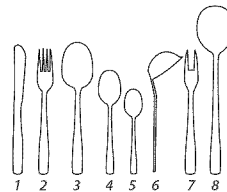

The dishwashers are tested to EN50242 standards for both wash and dry performances using the parameters detailed below.

Wash programme	Normal Eco
Detergent quantities	5g (pre-wash) 22g (main wash)
Rinse aid setting	4
Water softener setting	Adjust the water softener to match the water hardness. Refer to the 'Water softener' and 'Option adjustments' sections.
Maximum place setting	9
Accessories to be used in the dishwasher standards test	Base rack, 'slide-and-fold' tines, cutlery basket with cutlery grid, adjustable racks, glass supports, multi-purpose clip.
Height setting of adjustable racks	

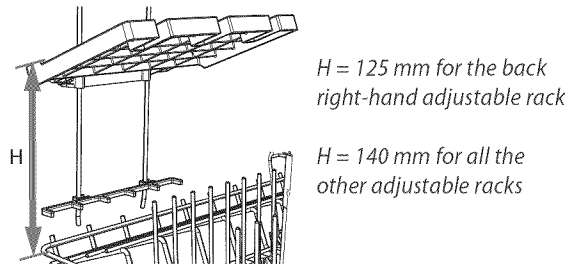

Correct orientation of glass supports on both sides of drawer

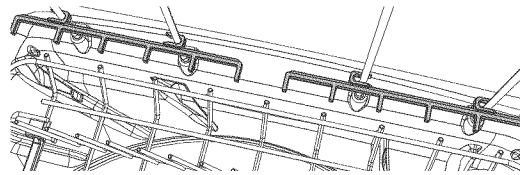

Recommended loading pattern

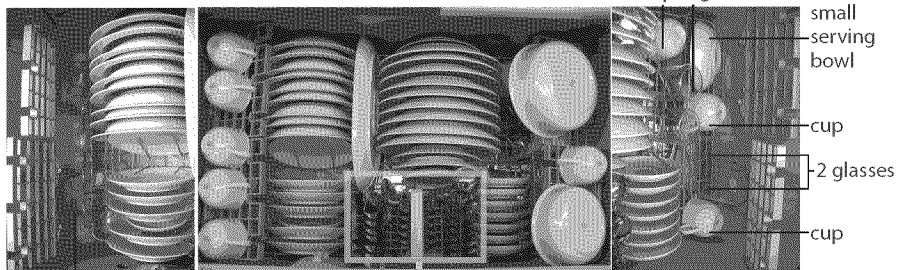

5 glasses under left-hand adjustable rack

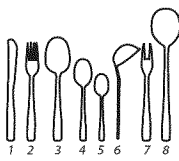
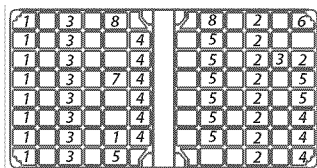

Cutlery basket

[www.fisherpaykel.com](http://www.fisherpaykel.com)

*Fisher & Paykel*

Copyright © Fisher & Paykel 2014. All rights reserved.  
The product specifications in this booklet apply to the specific products and models described at the date of issue. Under our policy of continuous product improvement, these specifications may change at any time. You should therefore check with your Dealer to ensure this booklet correctly describes the product currently available.

US CA NZ AU GB IE

F&P PN - 590199 D

06.2014