

MONESSEN HEARTH SYSTEMS

Natural Gas Models
DB24NTG / DB24NTS
DF24NTG / DF24NTS
DF24NMG / DF24NMS
DF32NTG / DF32NTS
DF32NMG / DF32NMS

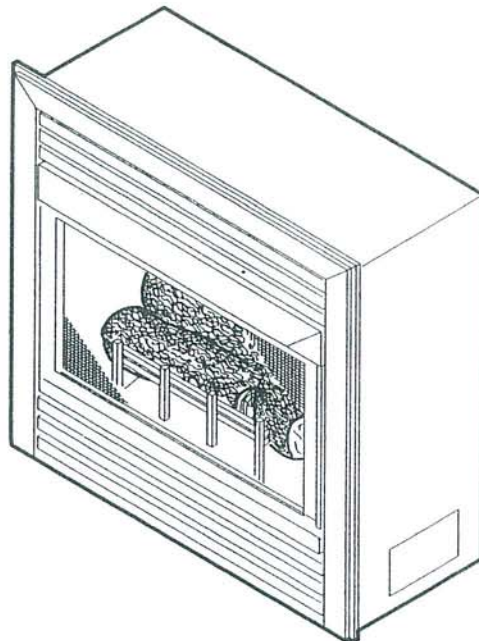

Propane (LPG) Models
DB24PTG / DB24PTS
DF24PTG / DF24PTS
DF24PMG / DF24PMS
DF32PTG / DF32PTS
DF32PMG / DF32PMS

UNVENTED GAS LOG FIREPLACE INSTALLATION AND OPERATING INSTRUCTIONS



This is an unvented gas-fired heater. It uses air (oxygen) from the room in which it is installed. Provisions for adequate combustion and ventilation air must be provided.

WARNINGS

If the information in this manual is not followed exactly, a fire or explosion may result causing property damage, personal injury or loss of life.

- Do not store or use gasoline or other flammable vapors and liquids in the vicinity of this or any other appliance.
- **WHAT TO DO IF YOU SMELL GAS**
 - Do not try to light any appliance.
 - Do not touch any electrical switch; do not use any phone in your building.
 - Immediately call your gas supplier from a neighbor's phone. Follow the gas supplier's instructions.
 - If you cannot reach your gas supplier, call the fire department.
- Installation and service must be performed by a qualified installer, service agency or the gas supplier.

READ AND SAVE THESE INSTRUCTIONS

CONTENTS

IMPORTANT SAFETY INFORMATION	1
PRODUCT FEATURES	3
PRODUCT FEATURES / SPECIFICATIONS	4
CONTENTS	5
ITEMS REQUIRED FOR INSTALLATION	6
INSTALLATION	7
GAS CONNECTION	11
GAS PRESSURE CHECK	13
LOG PLACEMENT	14
OPERATING INSTRUCTIONS	15
SHUTTING OFF HEATER	16
MANUAL CONTROL LIGHTING	17
THERMOSTAT CONTROL LIGHTING	18
FLAME APPEARANCE	20
CLEANING and SERVICING	22
PARTS LIST and ILLUSTRATIONS	23
TROUBLE SHOOTING	34

IMPORTANT SAFETY INFORMATION

INSTALLER: Please leave these instructions with the owner.

OWNER: Please retain these instructions for future reference.

IMPORTANT: Read these instructions carefully before installing or trying to operate this unvented gas heater.

WARNING

Any modification to this unvented gas heater or its controls can be dangerous. Improper installation or use of the heater can cause serious injury or death from fire, burns, explosion or carbon monoxide poisoning.

1. **CARBON MONOXIDE POISONING:** Early signs of carbon monoxide poisoning are similar to the flu with headaches, dizziness and/or nausea. If you have these signs, obtain fresh air immediately. Have the heater serviced as it may not be operating properly.
2. The installation must conform with local codes or, in the absence of local codes, with the National Fuel Gas Code, ANSI Z223.1.
3. This unit complies with ANSI Z21.11.2b-1995 Unvented Heaters.
4. The DB24PTG, DB24PTS, DB24NTG, DB24NTS unvented gas heater system may be installed in a bedroom per local codes with the wall support kit provided. The DF24 and DF32 series **MUST NOT** be installed in a bedroom.
5. Do not install the heaters in a bathroom.
6. Installation and repair should be done by a qualified service person.
7. To prevent malfunction and/or sooting, an unvented gas heater should be cleaned at least annually by a professional service person. More frequent cleaning may be required due to excessive lint from carpeting, etc. It is imperative that control compartments, burners and circulating air passageways be kept clean.
8. Correct placement of the ceramic fiber logs is necessary to avoid problems with sooting. Sooting can settle on surfaces outside the heater and cause discoloration. See the appropriate sections of this manual for instructions.
9. Avoid any drafts that alter burner flame patterns. Do not allow fans to blow directly into fireplace. Do not place a blower inside burn area of firebox. Ceiling fans may create drafts that alter burner flame patterns. Sooting and improper burning will occur.

IMPORTANT SAFETY INFORMATION

10. This is an unvented gas-fired heater. It uses air (oxygen) from the room in which it is installed. Provisions for adequate combustion and ventilation air must be provided. Refer to installation guidelines.
11. Children and adults should be alerted to the hazard of high surface temperature and should stay away to avoid burns or clothing ignition.
12. Young children should be carefully supervised when they are in the same room with the heater.
13. Do not place clothing or other flammable material near the fireplace when the heater is in use.
14. Keep room area clear and free from combustible materials, gasoline and other flammable vapors and liquids.
15. Any safety screen or guard removed for servicing, must be replaced prior to operating the heater.
16. This unvented gas heater is intended to be smokeless. If logs appear to smoke, turn off the heater and call a qualified service person. Initial burn off may cause slight smoke and odor during the first four hours of operation.
17. Input ratings are shown in BTU per hour and are for elevations up to 2,000 feet. For elevations above 2,000 feet, input ratings should be reduced 4 percent for each 1,000 feet above sea level. Refer to the National Fuel Gas Code.
18. The heater and its individual shutoff valve must be disconnected from the gas supply piping system during any pressure testing of that system at test pressures in excess of 1/2 psig (3.5 kPa).
19. The heater must be isolated from the gas supply piping system by closing its individual manual shutoff valve during any pressure testing of the gas supply piping system at test pressures equal to or less than 1/2 psig (3.5 kPa).
20. Do not use this room heater if any part has been under water. Immediately call a qualified service technician to inspect the room heater and to replace any part of the control system and any gas control which has been under water.
21. Due to high temperatures, the heater should be located out of traffic and away from furniture and draperies.

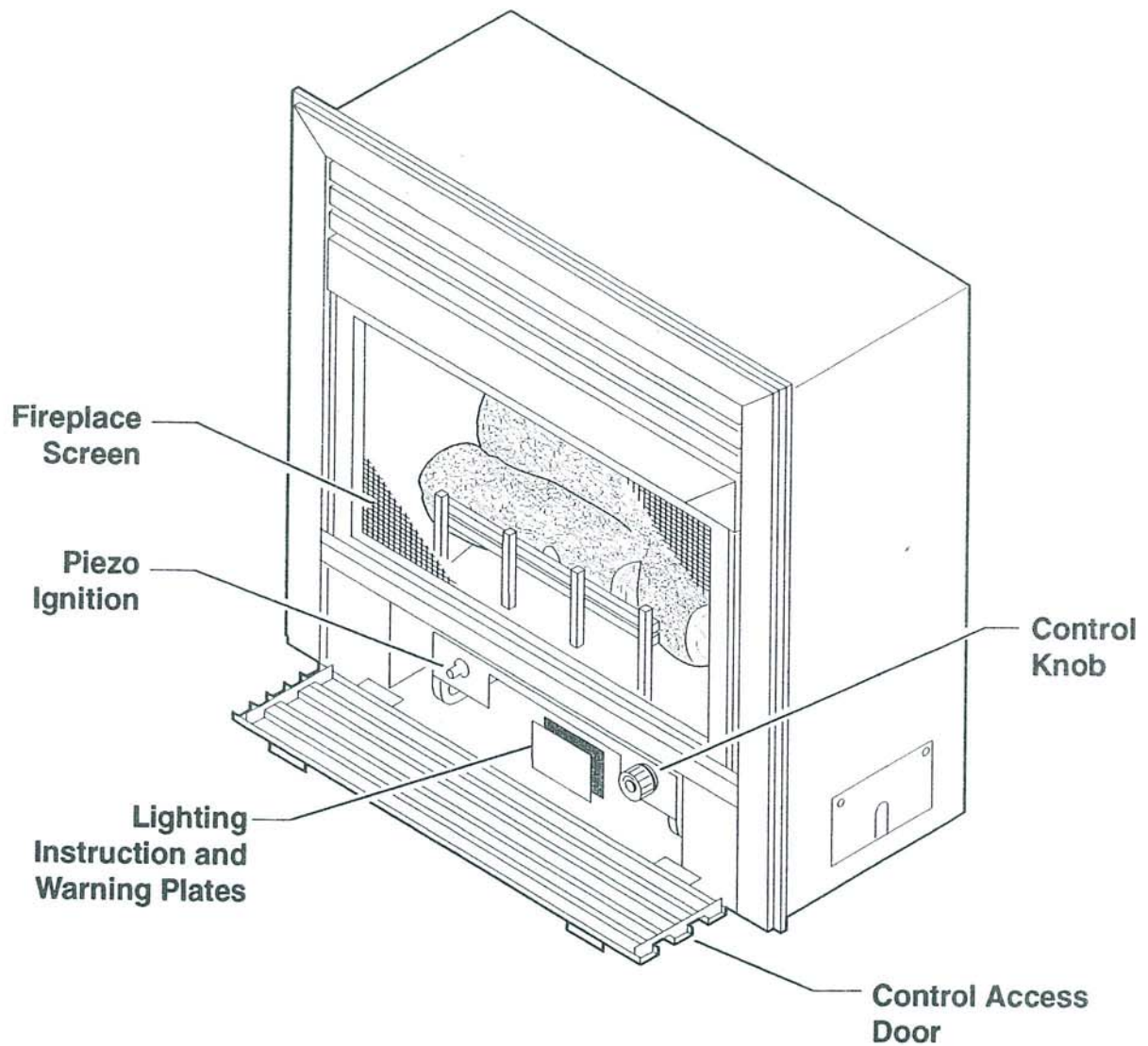

**FIGURE 1. Unvented Gas Heater
(Control Access Door Shown Open)**

Your vent-free fireplace must be mounted on the floor or on the optional fireplace hearth.

OPERATION

This unvented gas heater requires no outside venting, burns cleanly with high heating efficiency.

This zero-clearance unvented gas heater can be installed against (or recessed into) any wall that is accessible to a gas line.

PRODUCT FEATURES/SPECIFICATIONS

Natural Gas

Regulator Pressure Setting 3" w.c.
 Gas Inlet Pressure Maximum 10 1/2" w.c.
 Minimum 5" w.c.

Model No.	Type	Gas Rate		Number of Burners
		Max BTU/Hr	Min BTU/Hr	
DF24NMG / DF24NMS	Manual	20,000	10,000	2
DF24NTG / DF24NTS	T-stat	20,000	15,000	2
DB24NTG / DB24NTS	T-stat	10,000	N/A	1
DF32NMG / DF32NMS	Manual	28,000	19,000	2
DF32NTG / DF32NTS	T-stat	28,000	18,000	2

Propane / LPG

Note: An external regulator is required to reduce supply pressure to a maximum of 13" w.c.
 Regulator Pressure Setting 10" w.c.
 Gas Inlet Pressure Maximum 13" w.c.
 Minimum 11" w.c.

Model No.	Type	Gas Rate		Number of Burners
		Max BTU/Hr	Min BTU/Hr	
DF24PMG / DF24PMS	Manual	20,000	10,000	2
DF24PTG / DF24PTS	T-stat	20,000	15,000	2
DB24PTG / DB24PTS	T-stat	10,000	N/A	1
DF32PMG / DF32PMS	Manual	24,000	14,000	2
DF32PTG / DF32PTS	T-stat	24,000	17,000	2

Ignition - Piezo ignitor allows ignition of the pilot without the use of matches or batteries.

Controls- Manual control has 4 positions:

1. **OFF** - All gas to the gas logs is shut off at the valve
2. **IGN** - Valve position to light / maintain a standing pilot
3. **LOW** - Minimum gas rate - front burner provides a realistic glow on the center log.
4. **HI** - Maximum gas rate - front burner provides a realistic glow on the center log and the rear burner provides a pleasing yellow flame

Thermostat Control has 3 positions:

1. **OFF** - All gas to the gas logs is shut off at the valve
2. **IGN** - Valve position to light / maintain a standing pilot
3. **LOW/HI** - Variable position adjustable to a comfortable room temperature, both front and rear burners are in operation to provide realistic glow and yellow flame

DF32 Fireplace System

1. Packet containing Homeowners/Installation instructions and two anchoring screws.
2. Log box containing front and rear logs, refer to installation instructions.
3. 32" unvented gas heater.

DF24 Fireplace System

1. Packet containing Homeowners/Installation instructions and two anchoring screws.
2. 24" unvented gas heater (20,000 BTU/Hr) with integral logs.

DB24 Fireplace System

1. Packet containing Home-owners/Installation instructions and two anchoring screws.
2. Wall support kit
3. 24" unvented gas heater (10,000 BTU/Hr) with integral logs.

CHECK THAT ALL LISTED PARTS HAVE BEEN RECEIVED.

CAUTION

HANDLE GAS LOG BURNER ASSEMBLY BY THE BASE ONLY. DO NOT PICK UNIT UP BY THE BURNERS.

CAUTION

GLOVES ARE RECOMMENDED WHEN HANDLING CERAMIC FIBER LOGS TO PREVENT SKIN IRRITATION FROM LOOSE FIBERS. LOGS ARE FRAGILE, HANDLE WITH CARE.

Carefully inspect the contents for shipping damage and immediately inform your dealer if any damage is found.

ITEMS REQUIRED FOR INSTALLATION

Remove fireplace screen by removing two bottom screws on either side and pulling frame clear and down (FIGURE 3).

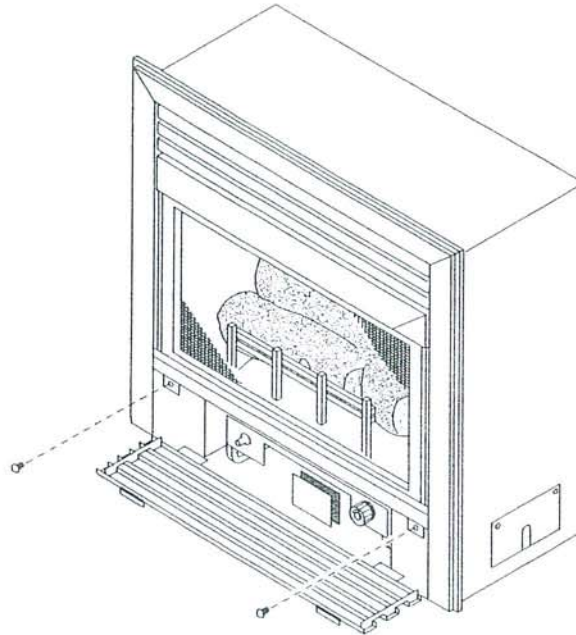

FIGURE 3. Removing Fireplace Screen

ITEMS REQUIRED FOR INSTALLATION

Ensure that the following items are available before proceeding with installation:

- External regulator (for propane/L.P.G. only)
- Piping which complies with local codes
- Pipe sealant approved for use with propane/L.P.G. (resistant to sulfur compounds)
- Manual shutoff valve
- Sediment trap
- Tee joint
- Pipe wrench
- Phillips head screwdriver
- 1/4" nut driver or wrench
- Wall support kit for installation of the DB24NTG / DB24PTG in a bedroom

CODES

Adhere to all local codes or, in their absence, the latest edition of THE NATIONAL FUEL GAS CODE ANSI Z223.1 or NFPA54 which can be obtained from:

American National Standards Institute, Inc.

1430 Broadway
New York, NY 10018

or

National Fire Protection Association, Inc.

Batterymarch Park
Quincy, MA 02269

WARNING

Do not install the heater:

- Where curtains, furniture, clothing, or other flammable objects are less than 42" from the front of the heater.
- In high traffic areas.
- In windy or drafty areas.

ADEQUATE COMBUSTION AND VENTILATION AIR

This heater shall not be installed in a confined space unless provisions are provided for adequate combustion and ventilation air.

The National Fuel Gas Code defines a confined space as a space whose volume is less than 50 cubic feet per 1,000 BTU per hour (4.8 m³ per kw) of the aggregate input rating of all appliances installed in that space and an unconfined space is defined as a space whose volume is not less than 50 cubic feet per 1,000 BTU per hour (4.8 m³ per kw) of the aggregate input rating of all appliances installed in that space. Rooms communicating directly with the space in which the appliances are installed, through openings not furnished with doors, are considered a part of the unconfined space.

INSTALLATION

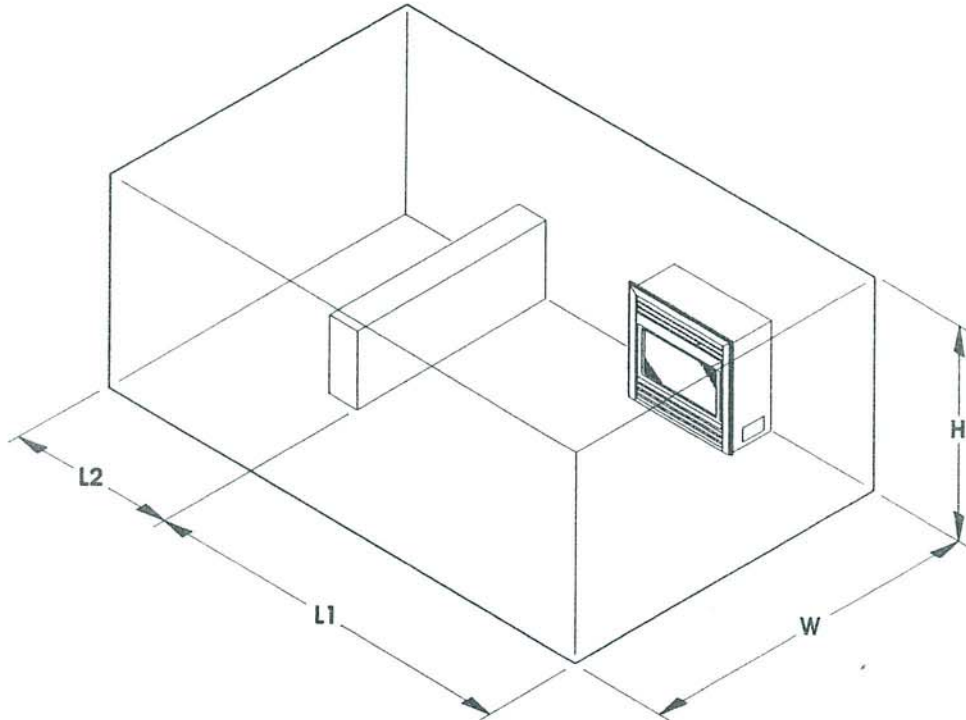

The following formula can be used to determine the maximum heater rating per the definition of unconfined space:

$$\text{BTU/HR} = \frac{(L1 + L2) \text{ Ft} \times (W) \text{ Ft} \times (H) \text{ Ft} \times 1000}{50}$$

Consider two connecting rooms with an open area between, with the following dimensions:
L1 = 15 1/2 Ft., L2 = 12 Ft., W = 12 Ft., H = 8 Ft.

$$\begin{aligned} \text{BTU/HR} &= \frac{(15 \frac{1}{2} + 12) \times (12) \times (8) \times 1000}{50} \\ &= 52800 \text{ BTU/HR} \end{aligned}$$

If there were a door between the two rooms the calculation would be based only on the room with the heater.

$$\begin{aligned} \text{BTU/HR} &= \frac{(15 \frac{1}{2}) \times (12) \times (8) \times 1000}{50} \\ &= 29760 \text{ BTU/HR} \end{aligned}$$

WARNING

If the area in which the heater may be operated is smaller than that defined as an unconfined space, provide adequate combustion and ventilation air by one of the methods described in the National Fuel Gas Code, ANSI Z223.1, 1992, Section 5.3.

WARNING

Ensure the minimum clearances shown in FIGURES 4 and 5 are maintained. Left and right clearances are determined when facing the front of the heater.

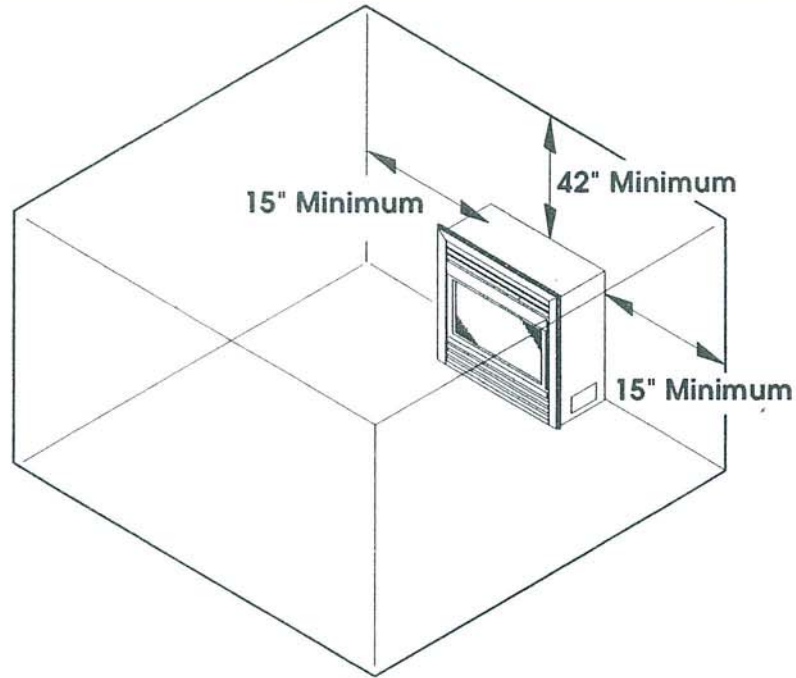

FIGURE 4. Minimum Clearances - Top and Sides of Room Heater to Ceiling and Walls

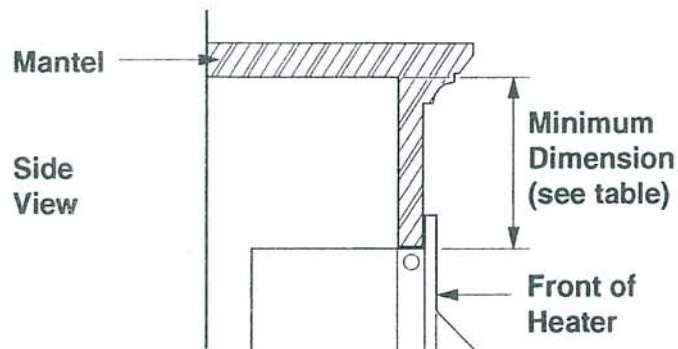

FIGURE 5. Minimum Distances From Projections Above Heater

Model	Min. Dimension
DF24 Fireplace System	5"
DB24 Fireplace System	5"
DF32 Fireplace System	9"

INSTALLATION

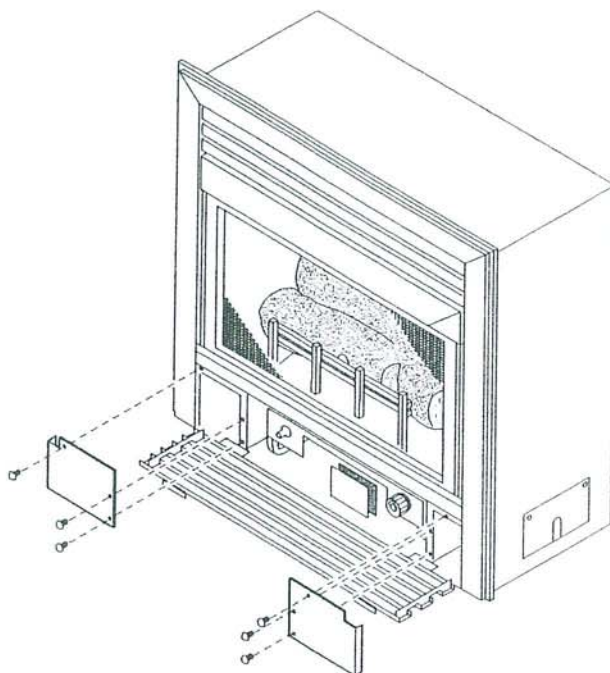

FIGURE 6. Removing Left and Right Inner Access Panels (DF32 only)

To prevent movement of the heater, the unit must be secured to the floor or hearth. Open the control access door, on the DF32 remove the right and left side covers, see FIGURE 6. Secure the heater with the two anchoring screws (3/16" x 1 1/4" length) supplied with the fireplace system. If the unit is mounted on carpeting, tile, or other combustible material without the hearth, a metal or wooden base covering the entire width and depth of the base must be installed.

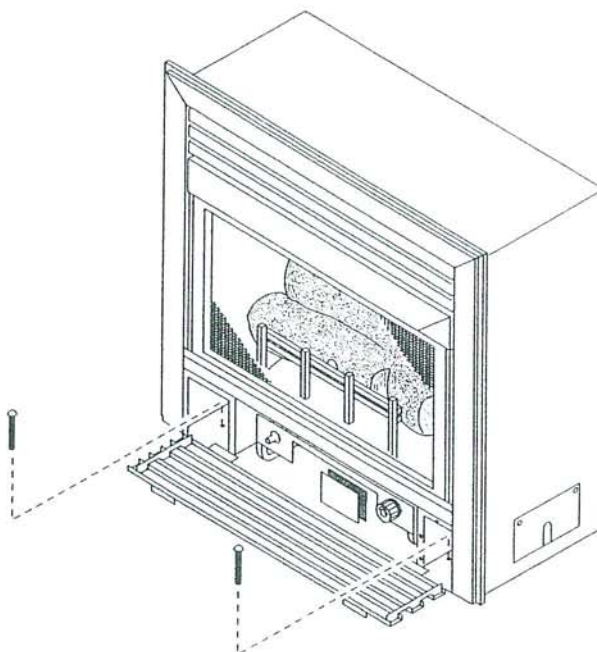

FIGURE 7. Securing Heater to Floor or Hearth

NOTICE

A qualified gas appliance installer must connect the fireplace to the gas supply.
Consult all local codes.

CAUTION

Use new black iron or steel pipe only. Internally tinned copper tubing can be used in some areas when permitted by local codes. Only use pipe of 1/2" or greater diameter to allow full gas volume to heater. Excessive pressure loss will occur if the pipe is too small.

A manual shutoff valve, union and plugged 1/8" NPT pressure tapping point must be installed upstream of the heater (FIGURE 8).

A sediment trap must be installed upstream of the heater to prevent moisture and contaminants from passing through the pipe to the heater controls and burners. Failure to do so could prevent the heater from operating reliably (FIGURE 8).

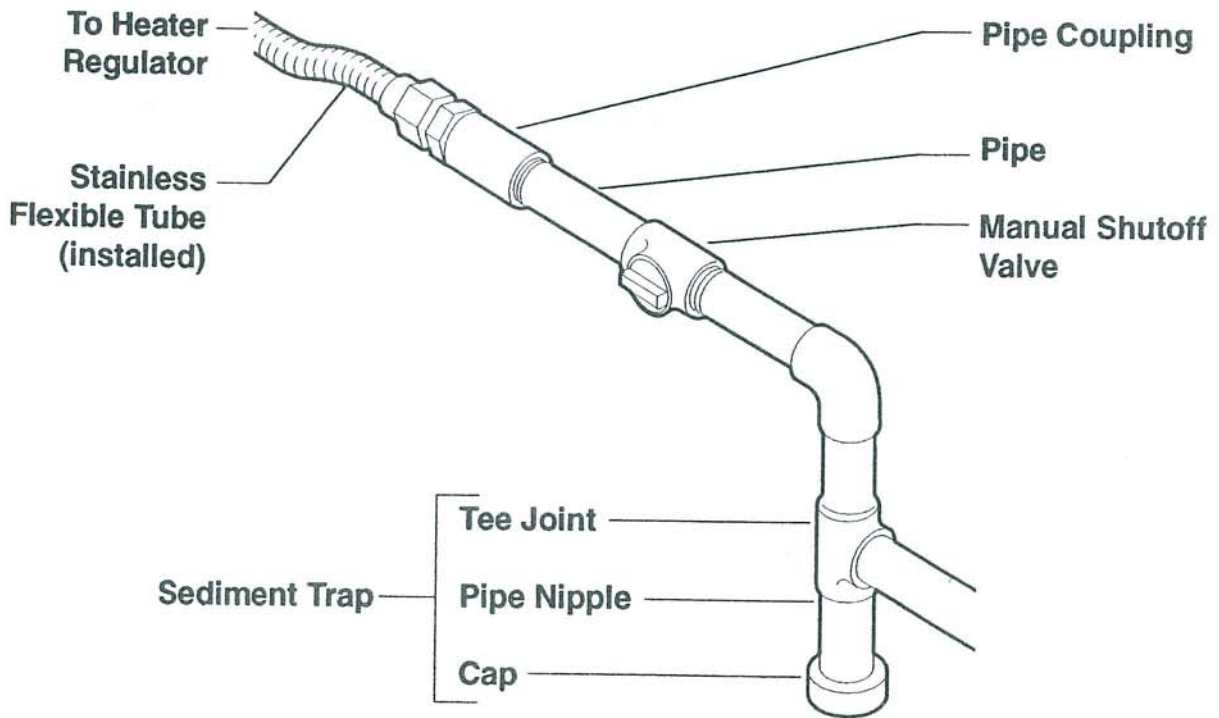

IMPORTANT: Loosen the pipe adapter on the flex tube before installing to the system piping.

FIGURE 8. Gas Connection

GAS CONNECTION (CONTINUED)

CHECK GAS TYPE: The gas supply must be the same as stated on heater's rating plate. If the gas supply is different, **DO NOT INSTALL** the heater. Contact your dealer for the correct model.

WARNING

Connecting directly to an unregulated propane/L.P.G. tank can cause an explosion.

To reach the regulator, remove two screws as shown in FIGURE 9 and lift out the right outer access plate.

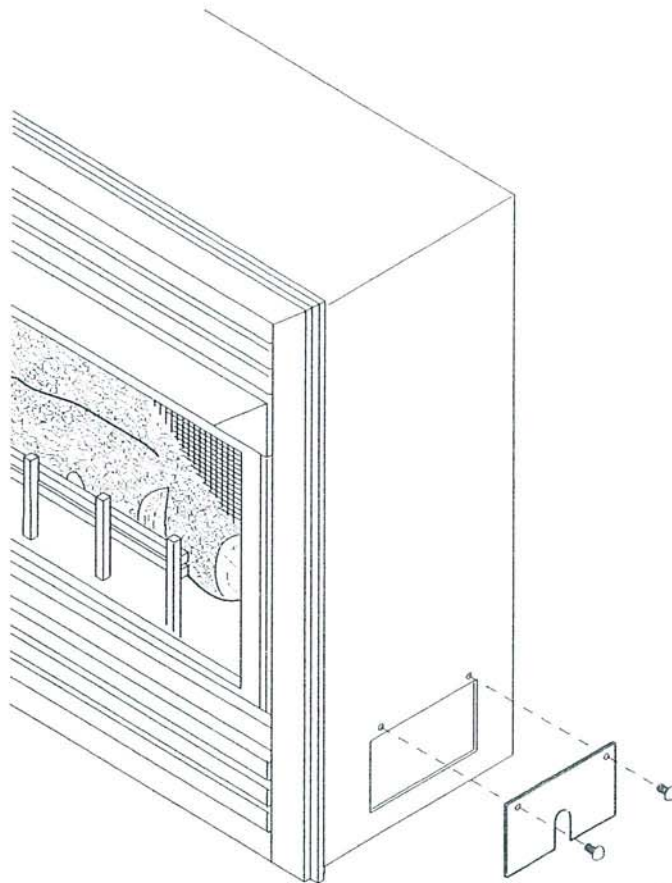

FIGURE 9. Removing Right Outer Access Plate

The regulator gas inlet connection is 3/8" NPT, made on the right side facing the fireplace.

Test all gas joints from the gas meter to the heater for leaks using soap and water solution after completing connection. **DO NOT USE AN OPEN FLAME.**

The heater regulator controls the burner pressure which should be checked at the pressure test point (1/8" NPT plug) located on the side of the regulator and is accessible from front (see FIGURE 10 or 10A).

The pressure should be checked with the heater burning and the control set to high (HI).

The pressure regulator is preset and locked to avoid tampering. If the pressure is not as specified in Product Specifications (page 4), contact your dealer and replace the regulator.

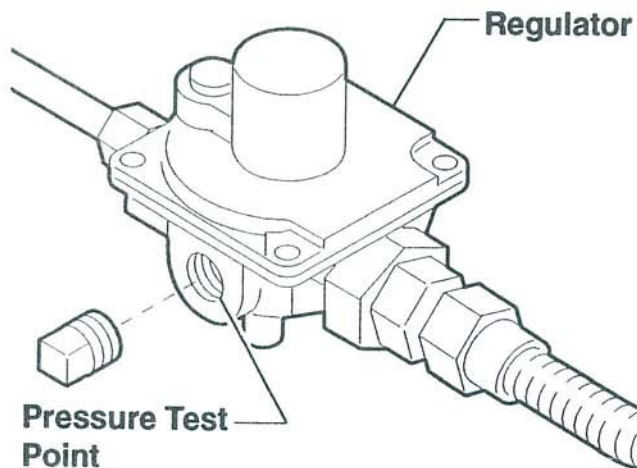

Remove 1/8" NPT plug, located on side of regulator body. Install fitting and tubing to pressure gauge. After taking pressure reading, re-install test plug.

Check for leaks.

FIGURE 10. Pressure Test Point Location

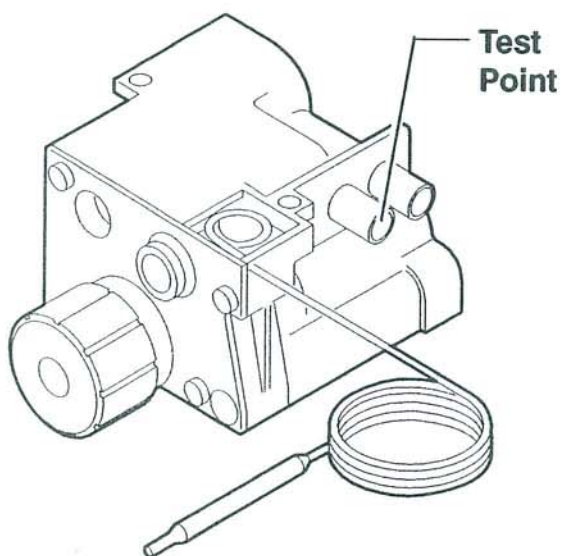

Turn captured screw counterclockwise 2 or 3 turns and then place tubing to pressure gauge over test point (use test point closest to control knob). After taking pressure reading. Be sure and turn captured screw clockwise firmly to re-seal. Do not over torque.

Check for gas leaks.

FIGURE 10a. Alternate Test Point Location for Thermostat Control Unit

DF 32 LOG PLACEMENT

Before you begin:

This unit is supplied with a set of two ceramic fiber logs. Do not handle these logs with your bare hands! **Always wear gloves to prevent skin irritation from ceramic fibers.** After handling logs, wash your hands gently with soap and water to remove any traces of fibers.

WARNING

The positioning of the logs is critical to the safe and clean operation of this heater. Sooting and other problems may result if the logs are not properly and firmly positioned in the heater. Never add additional logs or embellishment such as pine cones, vermiculite, volcanic rock or rock wool to the heater.

DF 32 Proper Installation Sequence:

1. Install the rear log (no. 2) on the top set of locating pins. Visually check to verify the log is securely placed on the pins, and in contact with the grate.
2. Install the front log (no. 1) on the bottom set of locating pins. Visually check to verify the log is securely placed on the pins.

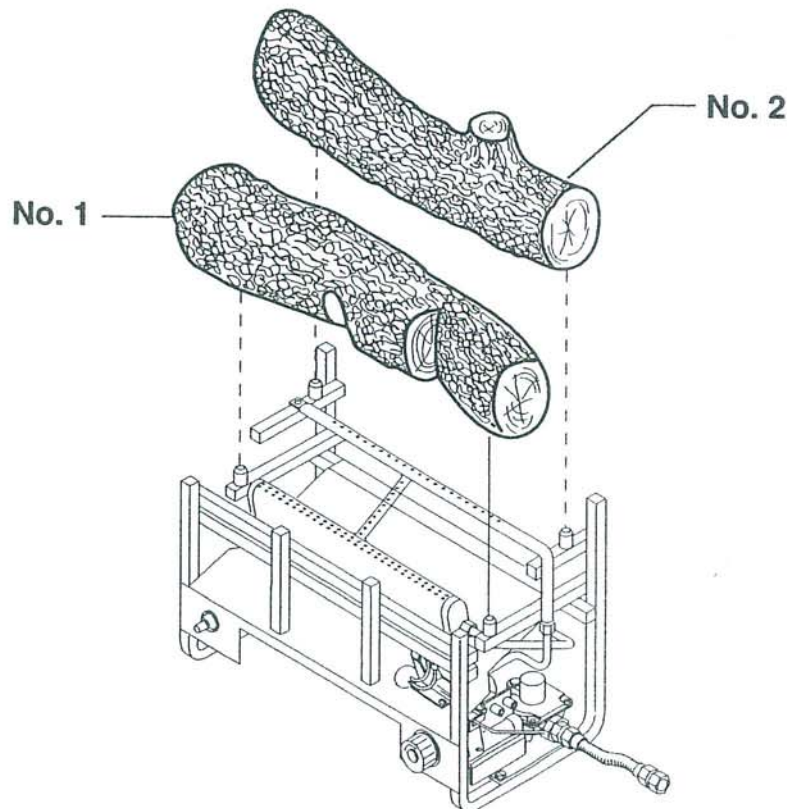

FIGURE 11. DF32 Log Placement

DB/DF 24 Proper Removal / Installation Sequence:

The heater is shipped with logs mounted with retaining screws. If necessary to remove the logs for cleaning or servicing the following sequence should be followed.

1. Remove the screen, Figure 3.
2. Remove the two screws that retain the front log and lift the log vertically off the log bracket. Removal of front grate may be required.
3. Remove the two screws that retain the rear log and lift the log vertically off the log bracket.
4. Install the rear log in the rear log cavity. Install the two mounting screws, do not over tighten.
5. Position the front log into the front log cavity to center the log. Install the two mounting screws, do not over tighten.

WARNING

Do not operate the heater without the log mounting screws installed and tightened, and the screen installed.

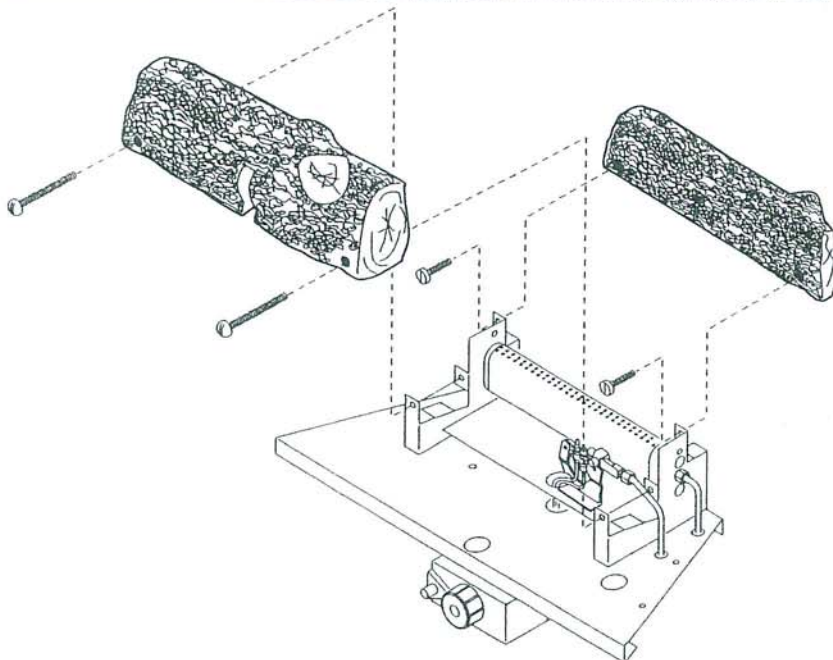

FIGURE 12. DB32 Log Placement

OPERATING INSTRUCTIONS

WARNING

Avoid any drafts that alter the burner flame patterns. Do not allow fans to blow directly into the fireplace. Do not place a blower inside burn area of firebox. Ceiling fans may create drafts that alter burner flame patterns. Sooting and improper burning will occur. Do not use a blower insert, heat exchange insert or other accessory not approved for use with this heater.

This unvented gas heater is intended to be smokeless. If logs appear to smoke, turn off the heater and call a qualified service person. Initial burn off may cause slight smoke and odor during the first four hours of operation.

FOR YOUR SAFETY READ BEFORE LIGHTING

WARNING

If you do not follow these instructions exactly, a fire or explosion may result causing property damage, personal injury or loss of life.

- A. This heater is equipped with an ignition device (piezo) which automatically lights the pilot.
- B. BEFORE LIGHTING smell all around the heater area for gas. Be sure to smell next to the floor because propane/LPG is heavier than air and will settle on the floor.

WHAT TO DO IF YOU SMELL GAS

- Do not attempt to light any appliance or heater.
 - Do not touch any electric switch; do not use any phone in your building.
 - Immediately call your gas supplier from a neighbor's phone. Follow the gas supplier's instructions.
 - If you cannot reach your gas supplier, call the fire department.
- C. Use only your hand to push in or turn the gas control knob. Never use tools. If the knob will not push in or turn by hand, don't try to repair or adjust the valve or mechanism. Call a qualified service technician. Force or attempted repair may result in a fire or explosion.
 - D. Do not use this heater if any part has been under water. Immediately call a qualified service technician to inspect the heater and to replace any part of the control system or any gas control which has been under water.

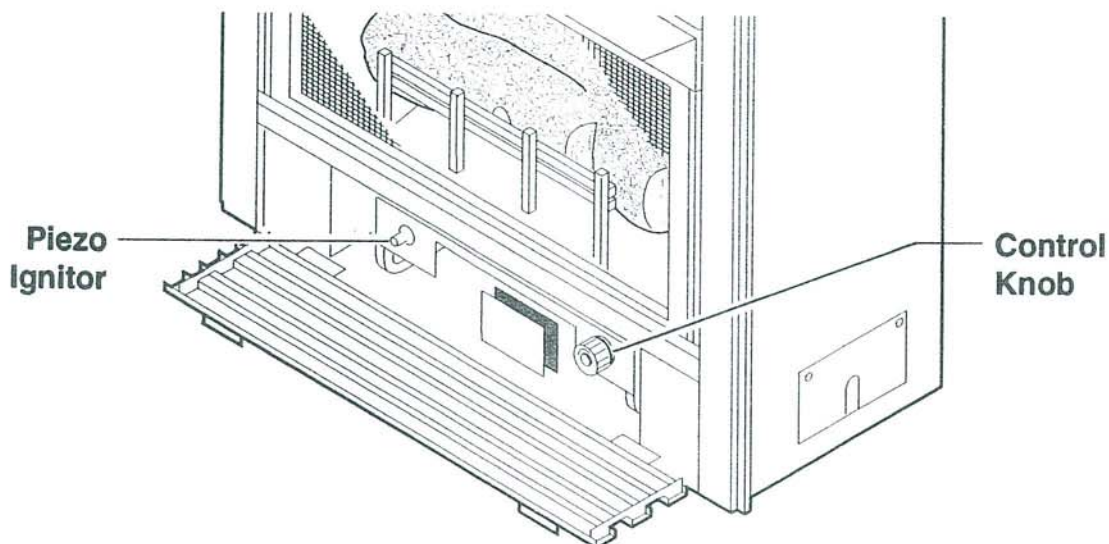



FIGURE 13

MANUAL CONTROL LIGHTING INSTRUCTIONS

1. STOP! Read the safety information.
2. Make sure manual shutoff valve is fully open.
3. This heater is equipped with an ignition device (piezo) which automatically lights the pilot.
4. Refer to illustration above for location of piezo ignitor and control knob. Push in gas control knob slightly and then turn clockwise  to the off position.

NOTE: Knob cannot be turned to off unless knob is pushed in slightly.

5. Wait 5 minutes to clear out any gas. Then smell for gas, including near the floor. If you smell gas, STOP! Follow the instructions under "WHAT TO DO IF YOU SMELL GAS". If you don't smell gas, go to the next step.
6. From off position, push in gas control knob counterclockwise  to the IGN position (FIGURE 14) Push and hold control knob for 5 seconds.

NOTE: If you are running the heater for the first time it will be necessary to press in the control knob for 30 seconds to allow air to bleed out of the gas piping.

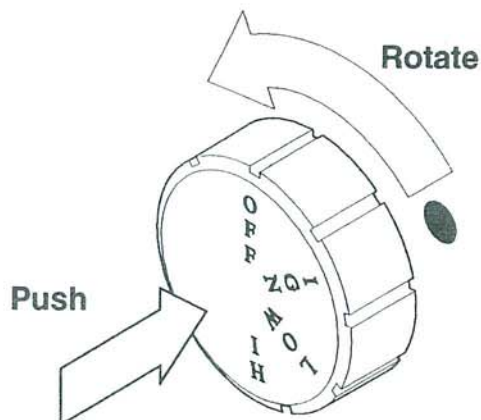



FIGURE 14. Control Knob



OPERATING INSTRUCTIONS



7. With the control knob pushed in, push and release the piezo ignitor button to light the ODS pilot. If piezo ignitor does not light the pilot, refer to "Match Lighting Instructions".
8. Hold the control knob in for a additional 10 seconds to prevent the ODS from shutting off the gas while the thermocouple is warming up.
9. Release the control knob.
 - If the control knob does not pop out when released, stop and immediately call your service technician or gas supplier.
 - If the ODS pilot will not stay lit after several tries, press and turn the gas control knob clockwise  to OFF and wait 15 seconds. Repeat steps 6 through 9.
10. Push in control knob and turn to desired setting (LOW or HIGH). The control knob must be set at either the low or high position, control knob will pop out when positioned correctly. Do not set the control knob at a position between LOW and HIGH.

WARNING

Wait 30 seconds before readjusting the heater when the control knob has been turned down to a lower setting.

THERMOSTATIC CONTROL LIGHTING INSTRUCTIONS

1. STOP! Read the safety information.
2. Make sure the manual shut off valve is fully open.
3. This heater is equipped with an ignition device (piezo) which automatically lights the pilot.
4. Refer to FIGURE 13 for location of piezo ignitor and control knob. Turn control knob clockwise  to OFF position.
5. Wait 5 minutes to clear out any gas. Then smell for gas, including near the floor. If you smell gas, STOP! Follow the instructions under "WHAT TO DO IF YOU SMELL GAS". If you don't smell gas, go to the next step.
6. Turn the control knob counterclockwise  to the IGN position (FIGURE 15). Push in and hold control knob for 5 seconds.

7. With the control knob pushed in and held, push and release the piezo ignitor button to light the ODS pilot. If piezo ignitor does not light refer to *"Match Lighting Instructions"*
8. Hold the control knob in for an additional 10 seconds to prevent the ODS pilot from shutting off the gas while the thermocouple is warming up.
9. Release the control knob.
 - If the knob does not pop out when released, stop and immediately call your service technician or gas supplier.
 - If the ODS pilot will not stay lit after several tries, press in and turn the control knob clockwise  to OFF release and wait 15 seconds. Repeat steps 6 through 9.
10. Turn control knob to any position between LOW or HIGH. The knob position controls the thermostat temperature.
11. The heater is now in proper operation. The following procedure should be used to achieve thermostatic control of the desired room temperature.
 - a. Operate unit at higher setting until desired room temperature is achieved.
 - b. At the desired temperature, slowly turn the control knob clockwise  and stop rotating when the flame disappears.
 - c. Thermostat is now set to maintain the current room temperature.
 - d. As the room temperature decreases, the thermostat valve will open to ignite the front and rear burner.
 - e. When the temperature reaches its set point (knob position) the thermostat valve will again shut off the front and rear burner.
 - f. This is the normal operating cycle of the heater.

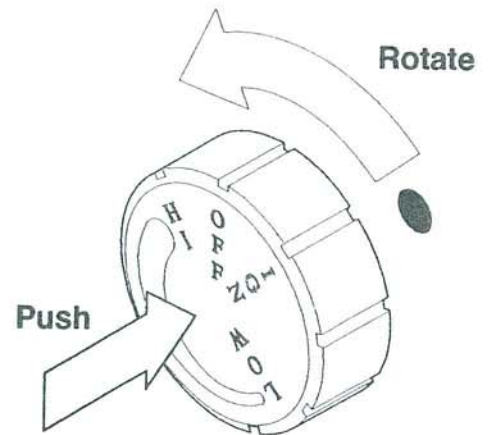



FIGURE 15. Control Knob

OPERATING INSTRUCTIONS

WARNING

Wait 30 seconds before readjusting the heater when the control has been turned down to a lower setting.

SHUTTING OFF HEATER

1. Refer to FIGURE 12. Turn control knob clockwise  to the OFF position.
2. If applicable: Turn off all electric power to the heater.

MATCH LIGHTING INSTRUCTIONS

1. Remove any items necessary for easy access to the pilot (for example: logs, screens etc).
2. Follow appropriate lighting instructions found previously. Instead of pushing and releasing the piezo button, light a match and hold the flame to the end of the pilot and ignite the pilot.
3. After control knob has been released and pilot stays lit, re-install any items that were removed for pilot access.
4. Call a qualified service technician for repair or replacement of the piezo ignitor.

CHECKING FLAME APPEARANCE

Flames from the pilot, front and rear burner should be visually checked when the heater is installed. In addition a periodic visual check of the flames should be made.

PILOT FLAME

The pilot flame should always be present when the heater is in operation and should just touch the top of the thermocouple tip (FIGURE 16).

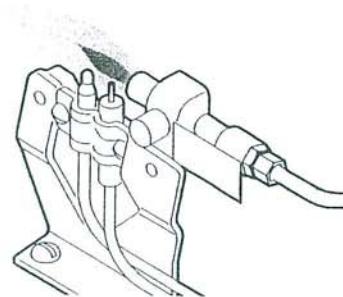

FIGURE 16. Pilot Flame

If the pilot flame does not touch the thermocouple, then the main burner is unlikely to function reliably (FIGURE 17).

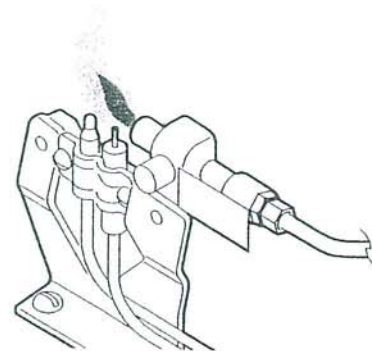

FIGURE 17. Incorrect Shape of Pilot Flame

FLAME APPEARANCE

In normal operation, at high setting, after 15 minutes, the following flame appearance should be observed:

REAR BURNER FLAMES

The rear flames above and behind Log No. 1, and in front of Log No. 2, may be yellow. The flames should extend about 2-3" above Log No. 1.

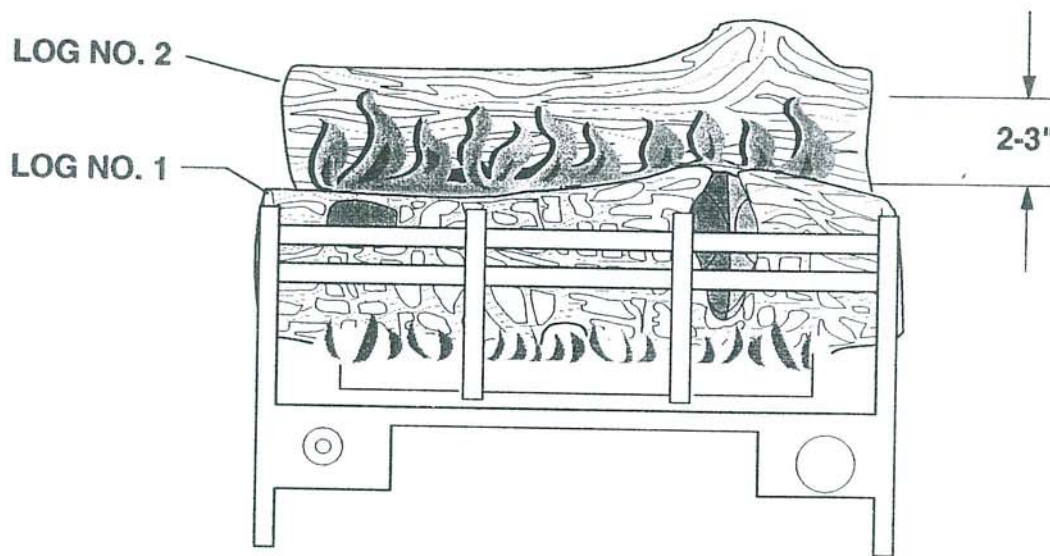

FIGURE 18 Main and Rear Burner Flame

MAIN BURNER FLAMES

The front burner flames are blue, and contact the face of the front log (FIGURE 18). The face of the front log will glow a bright reddish-orange when the heater is operated at the high setting. The DB24 is a single burner, yellow flame heater.

The DB24 will not have glow on the front log.

CLEANING and SERVICING

Annual inspection and cleaning by your dealer or qualified service technician is recommended to prevent malfunction and/or sooting.

WARNING

Turn off heater and allow to cool before cleaning. Disconnect electrical power (optional DF32 blower) before cleaning or servicing.

Remove fireplace screen, retaining screws. Carefully lower screen from mounting lugs and set aside during cleaning. Refer to instructions in manual for installation of screen. **Do not operate the unit with the screen removed.**

Remove logs, handling carefully by holding gently at each end. Gloves are recommended to prevent skin irritation from ceramic. If the skin becomes irritated, wash gently with soap and water. Refer to manual for correct log placement.

Periodic Cleaning - *Refer to parts diagram for location of items discussed below*

- Do not use cleaning fluid to clean logs or any part of heater.
- Logs - Brush with soft bristle brush or vacuum with brush attachment.
- Vacuum loose particles and dust from the front and rear burner, control, and piezo covers and grate weldment.
- Inspect and clean rear burner air intake holes. Remove lint or particles with vacuum or brush. Failure to keep air holes clean will result in sooting and poor combustion.
- External case should be dusted and wiped with a wet soapy cloth.

Annual Cleaning / Inspection - *Refer to parts diagram for location of items discussed below*

- Inspect and clean rear burner air intake holes. Remove lint or particles with vacuum or brush. Failure to keep air holes clean will result in sooting and poor combustion.
- Inspect and clean all burner ports.
- Inspect ODS pilot for operation and accumulation of lint at air intake holes.
- Verify flame pattern and log placement for proper operation.
- Verify smooth and responsive ignition of main burner and rear burner.

HEATER TRIM ILLUSTRATION and PARTS LIST

ITEM	DESCRIPTION	QTY	DF 24	DB 24	DF32
1	Assembly Screen	1	18D1202	18D1202	13B1005
2	Assembly Canopy	1	18D0111	18D0111	13B1006
3	Louver Top Black	3	18D0131	18D0131	13B0168
	Louver Top Brass	3	18D0132	18D0132	13B0169
4	Louver Door Black	3	18D0115	18D0115	13B0190
	Louver Door Brass	3	18D0116	18D0116	13B0196
5	Brass Surround Kit	1	18D2000	18D2000	13B2000
6	Manual-Home Owners	1	15D1995	15D1995	15D1995

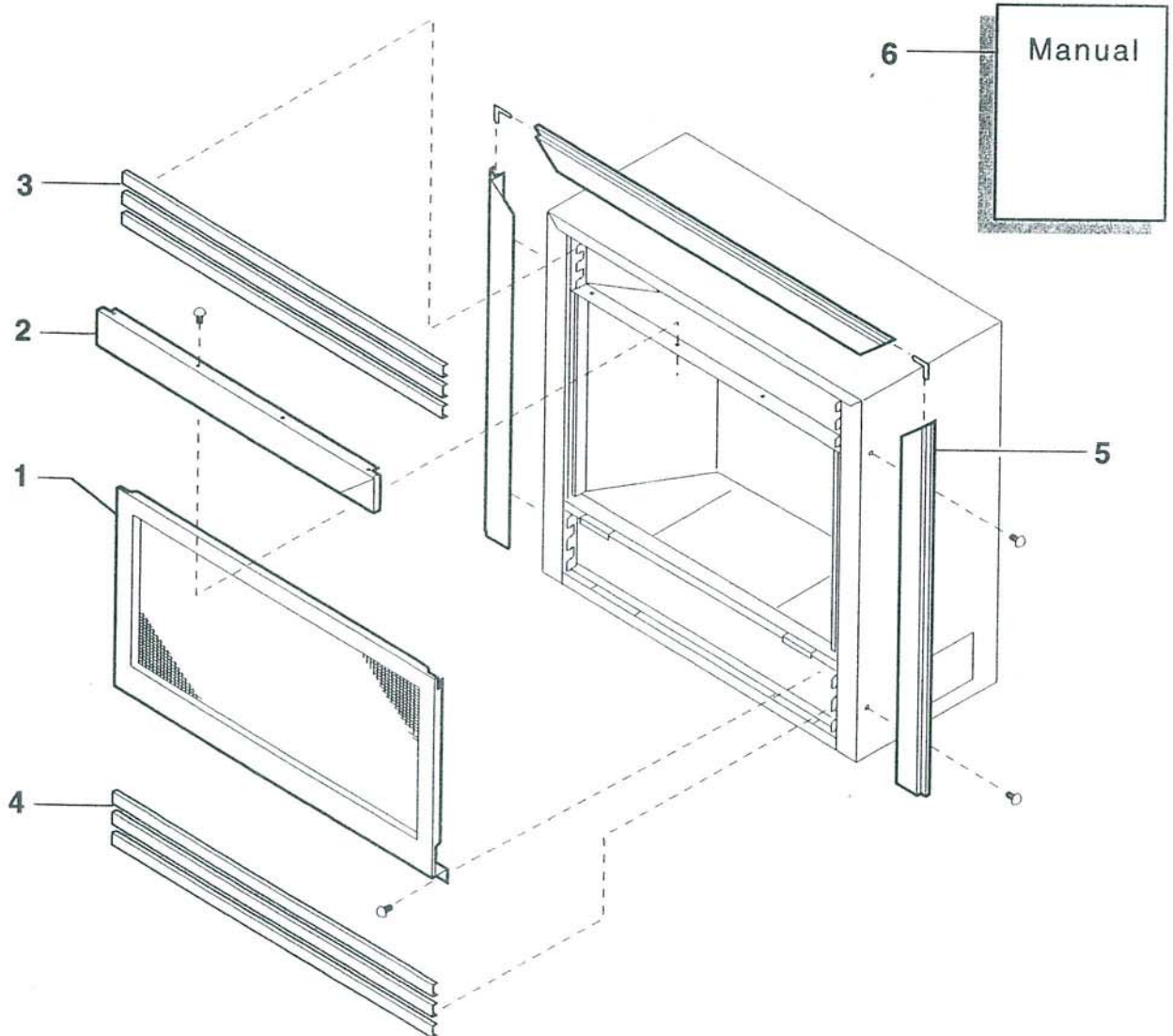

DF24 MANUAL CONTROL PARTS LISTS

ITEM	DESCRIPTION	QTY	NATURAL GAS	PROPANE
1	Burner Front	1	14D0516	14D0516
2	Injector Front	1	18D0510	18D0515
3	Burner Rear	1	18D0501	18D0501
4	Injector Rear	1	18D0514	18D0516
5	Valve, Manual Control	1	00K0910	00K0910
6	Valve Pressure Regulator	1	18D0351	18D0352
7	Tube 1/4 Valve/Rear Burner	1	18D0305	18D0305
8	Tube 1/4 Valve/Front Burner	1	18D0306	18D0306
9	Tube 5/16 Regulator/Valve	1	18D0307	18D0307
10	Tube 3/16 Valve/Pilot	1	18D0308	18D0308
11	Nut 1/4 Tube	4	00F0079	00F0079
12	Ferrule 1/4 Tube	4	00F0080	00F0080
13	Nut 3/16 Tube	2	00F0077	00F0077
14	Ferrule 3/16 Tube	2	00F0078	00F0078
15	Nut 5/16 Tube	2	00K0917	00K0917
16	Ferrule 5/16 Tube	2	00K0918	00K0918
17	Piezo Ignitor	1	00F0011	00F0011
17	Piezo Nut	1	00F0587	00F0587
18	Wire Piezo	1	00K0632	00K0632
19	ODS Pilot Assembly	1	15D1013	15D1022
20	Fitting - 3/8 x 5/16 Tube	1	11V0313	11V0313
21	Plug Pipe 1/8 NPT	1	00F0092	00F0092
22	Flex Tube with Fittings	1	20H0022	20H0022
	Log Set, Golden Oak			
23	Front Log	1	21D0902	21D0902
24	Rear Log	1	21D0903	21D0903
	Log Set, Split Oak			
23	Front Log	1	18D0903	18D0903
24	Rear Log	1	21D0903	21D0903

DF24 MANUAL CONTROL ILLUSTRATION

WARNING

Failure to position the parts in accordance with these diagrams or failure to use only parts specifically approved with this heater may result in property damage or personal injury.

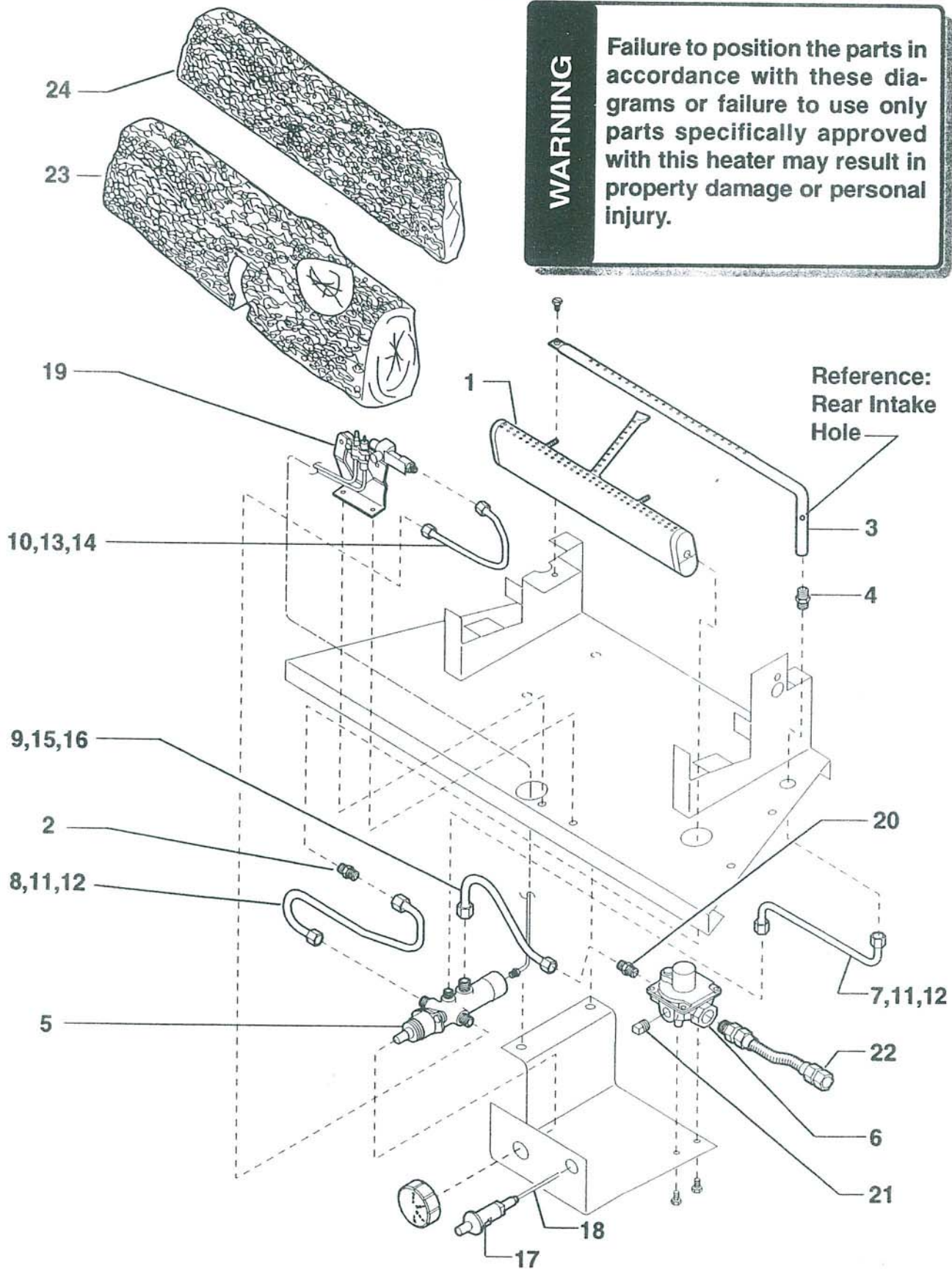

DF24T-STAT CONTROL PARTS LISTS

ITEM	DESCRIPTION	QTY	NATURAL GAS	PROPANE
1	Burner Front	1	14D0516	14D0516
2	Injector Front	1	18D0510	18D0515
3	Burner Rear	1	18D0501	18D0501
4	Injector Rear	1	18D0514	18D0516
5	Valve Control T-Stat	1	11V0701	11V0701
6	Screw Modulating (Min Flow)	1	945624	945618
7	Valve Pressure Regulator	1	18D0351	18D0352
8	Tube 1/4 Valve/Tee	1	18D0301	18D0301
9	Tube 1/4 Tee/Rear Burner	1	18D0302	18D0302
10	Tube 1/4 Tee/Front Burner	1	18D0303	18D0303
11	Tube 3/16 Valve/Pilot	1	18D0304	18D0304
12	Nut 1/4 Tube	4	00F0079	00F0079
13	Ferrule 1/4 Tube	4	00F0080	00F0080
14	Nut 3/16 Tube	1	00F0077	00F0077
15	Ferrule 3/16 Tube	2	00F0078	00F0078
16	Tee 1/4 Tube	1	00F0474	00F0474
17	Reverse Flare Nut, 3/16 Tube	1	11V0314	11V0314
18	Piezo Kit	1	18D0402	18D0402
19	Piezo Ignitor	1	18D0401	18D0401
20	Wire, Piezo	1	00K0632	00K0632
21	ODS Pilot Assembly	1	15D1013	15D1022
22	Fitting - 3/8 NPT x 1 1/2"	1	18D0310	18D0310
23	Fitting - 3/8 NPT 1/4 Tube	1	11V0312	11V0312
24	Plug Pipe 1/8 NPT	1	00F0092	00F0092
25	Flex Tube with Fittings	1	20H0022	20H0022
Log Set, Golden Oak				
26	Front Log	1	21D0902	21D0902
27	Rear Log	1	21D0903	21D0903
Log Set, Split Oak				
26	Front Log	1	18D0903	18D0903
27	Rear Log	1	21D0903	21D0903

DF24T-STAT CONTROL ILLUSTRATION

WARNING

Failure to position the parts in accordance with these diagrams or failure to use only parts specifically approved with this heater may result in property damage or personal injury.

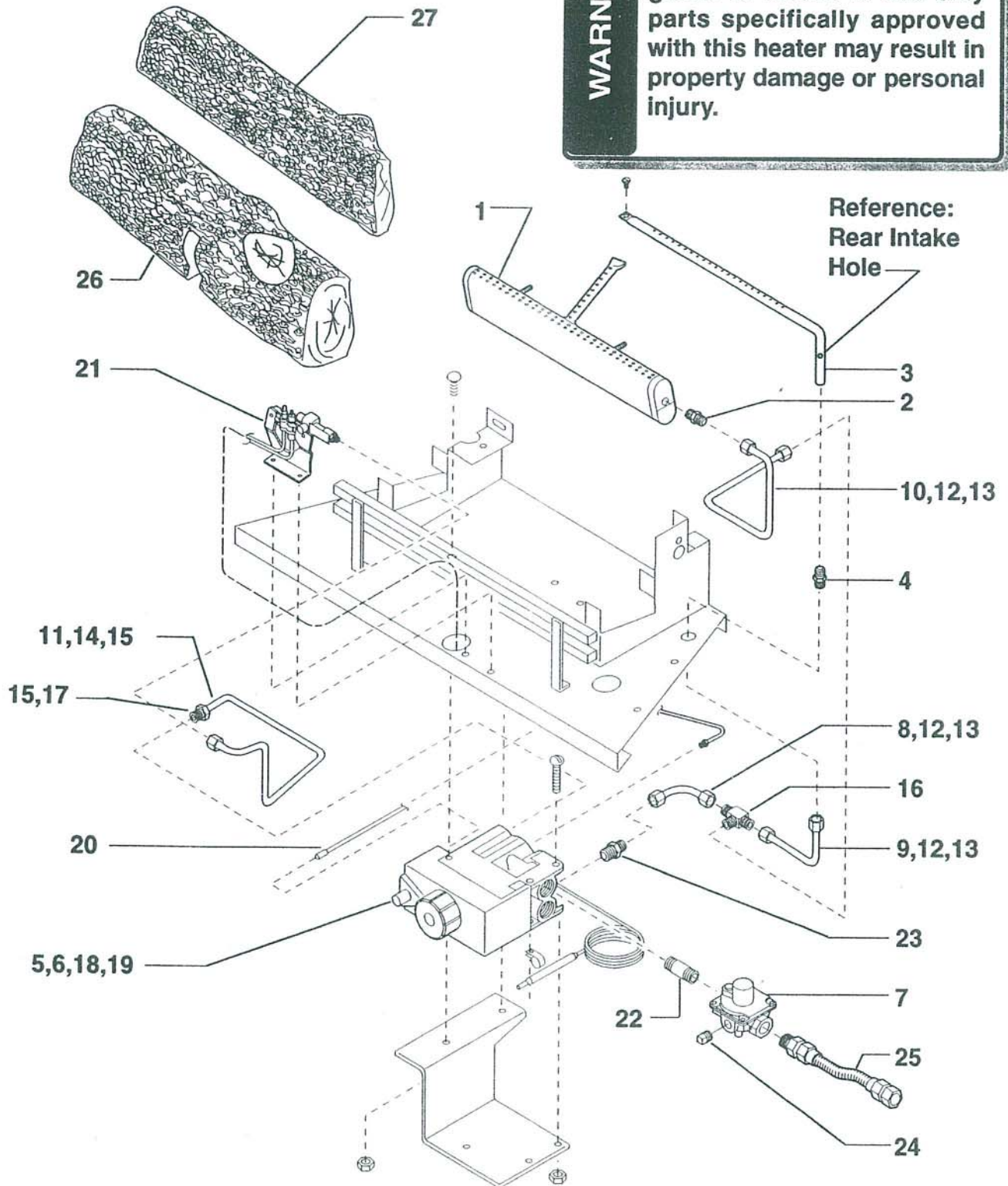

DB24T-STAT CONTROL PARTS LISTS

ITEM	DESCRIPTION	QTY	NATURAL GAS	PROPANE
1	Burner, Main	1	14D0517	14D0517
2	Injector, Main	1	18D0518	18D0517
3	Valve Control T-stat	1	11V0701	11V0701
4	Screw Modulating (Min Flow)	1	972057	972057
5	Valve Pressure Regulator	1	18D0351	18D0352
6	Tube 1/4 Tstat/Main Burner	1	18D0312	18D0312
7	Tube 3/16 Tstat/Pilot	1	18D0311	18D0311
8	Nut 1/4 Tube	2	00F0079	00F0079
9	Ferrule 1/4 Tube	2	00F0080	00F0080
10	Nut 3/16 Tube	1	00F0077	00F0077
11	Ferrule 3/16 Tube	2	00F0078	00F0078
12	Reverse Flare Nut 3/16" Tube	1	11V0314	11V0314
13	Piezo Kit	1	18D0402	18D0402
14	Piezo Ignitor	1	18D0401	18D0401
15	Wire Piezo	1	00K0632	00K0632
16	ODS Pilot Assembly	1	15D1013	15D1022
17	Fitting - 3/8 x 1 1/2 NPT	1	18D0309	18D0309
18	Fitting - 3/8x 1/4 Tube	1	11V0312	11V0312
19	Plug Pipe 1/8 NPT	1	00F0092	00F0092
20	Flex Tube with Fittings	1	20H0022	20H0022
Log Set, Golden Oak				
21	Front Log	1	18D0905	18D0905
22	Rear Log	1	21D0903	21D0903
Log Set, Split Oak				
21	Front Log	1	18D0906	18D0906
22	Rear Log	1	21D0903	21D0903

Optional Blower (Not Illustrated)		
Blower Kit	1	BLO-32
Switch	1	20H0103
Motor/Fan Assembly	1	13B0413
Harness, Wiring	1	13B0405

DB24T-STAT CONTROL ILLUSTRATION

WARNING

Failure to position the parts in accordance with these diagrams or failure to use only parts specifically approved with this heater may result in property damage or personal injury.

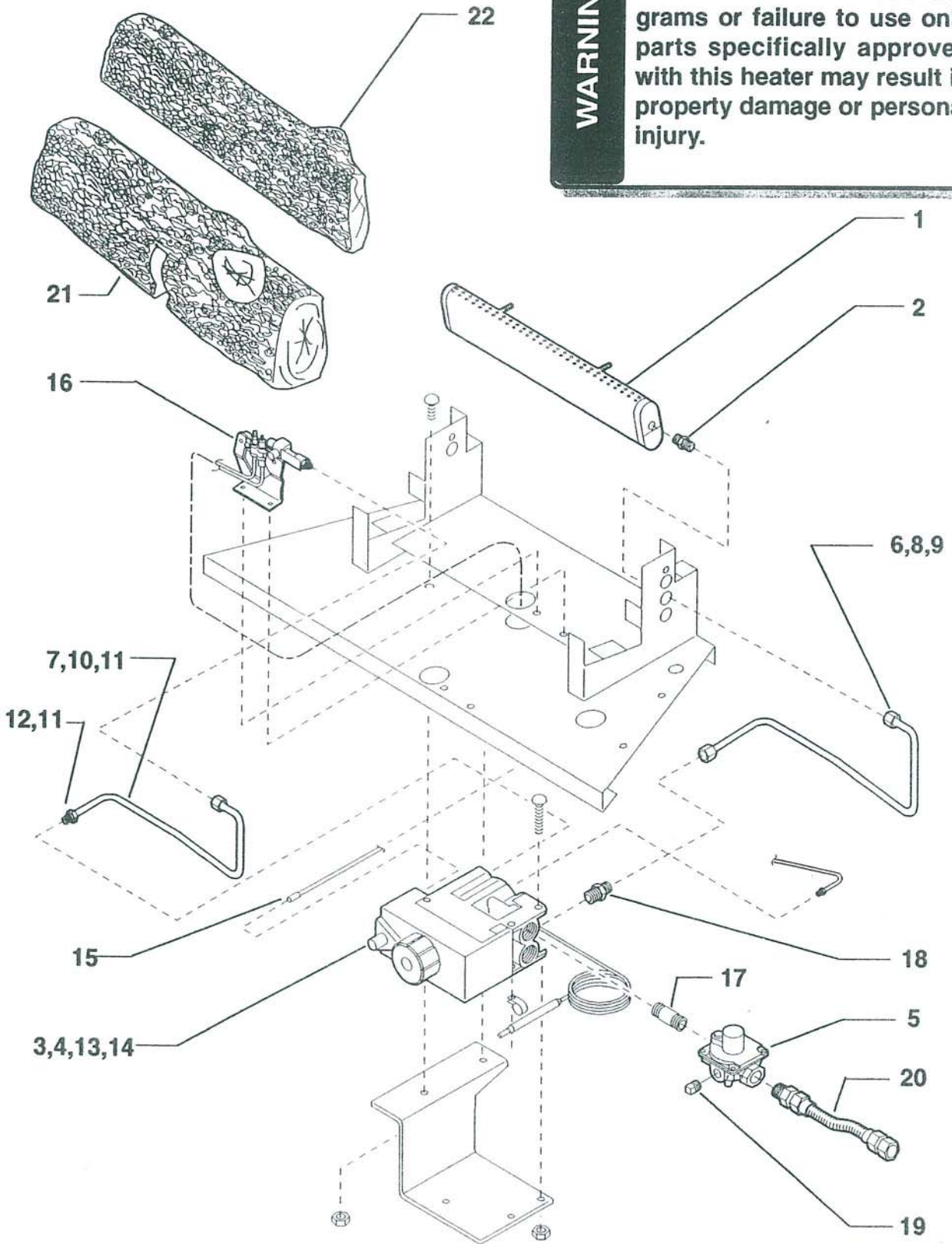

DF32 MANUAL CONTROL PARTS LISTS

ITEM	DESCRIPTION	QTY	NATURAL GAS	PROPANE
1	Burner Front	1	14D0512	14D0512
2	Injector Front	1	00K0913	00K0915
3	Burner Rear	1	13B0531	13B0532
4	Injector Rear	1	15D0552	15D0550
5	Valve Control Manual	1	00K0910	00K0910
6	Valve Pressure Regulator	1	18D0351	18D0352
7	Tube 5/16 Regulator/Valve	1	15D0324	15D0324
8	Nut 5/16 Tube	2	00K0917	00K0917
9	Ferrule 5/16 Tube	2	00K0918	00K0918
10	Tube 1/4 Valve/Front Burner	1	15D0321	15D0321
11	Tube 1/4 Valve/Rear Burner	1	15D0322	15D0322
12	Nut 1/4 Tube	4	00F0079	00F0079
13	Ferrule 1/4 Tube	4	00F0080	00F0080
14	Tube 3/16 Valve/ODS Pilot	1	15D0320	15D0320
15	Nut 3/16 Tube	2	00F0077	00F0077
16	Ferrule 3/16 Tube	2	00F0078	00F0078
17	Piezo Ignitor	1	14D0503	14D0503
18	Wire Piezo	1	00K0632	00K0632
19	ODS Pilot Assembly	1	15D1013	15D1022
20	Plug Pipe 1/8 NPT	1	00F0092	00F0092
21	Flex Tube with Fittings	1	20H0022	20H0022
	Log Set, Golden Oak			
22	Front Log	1	15D0905	15D0905
23	Rear Log	1	15D0906	15D0906
	Log Set, Split Oak			
22	Front Log	1	15D2906	15D2906
23	Rear Log	1	15D2907	15D2907

DF32 MANUAL CONTROL ILLUSTRATION

WARNING

Failure to position the parts in accordance with these diagrams or failure to use only parts specifically approved with this heater may result in property damage or personal injury.

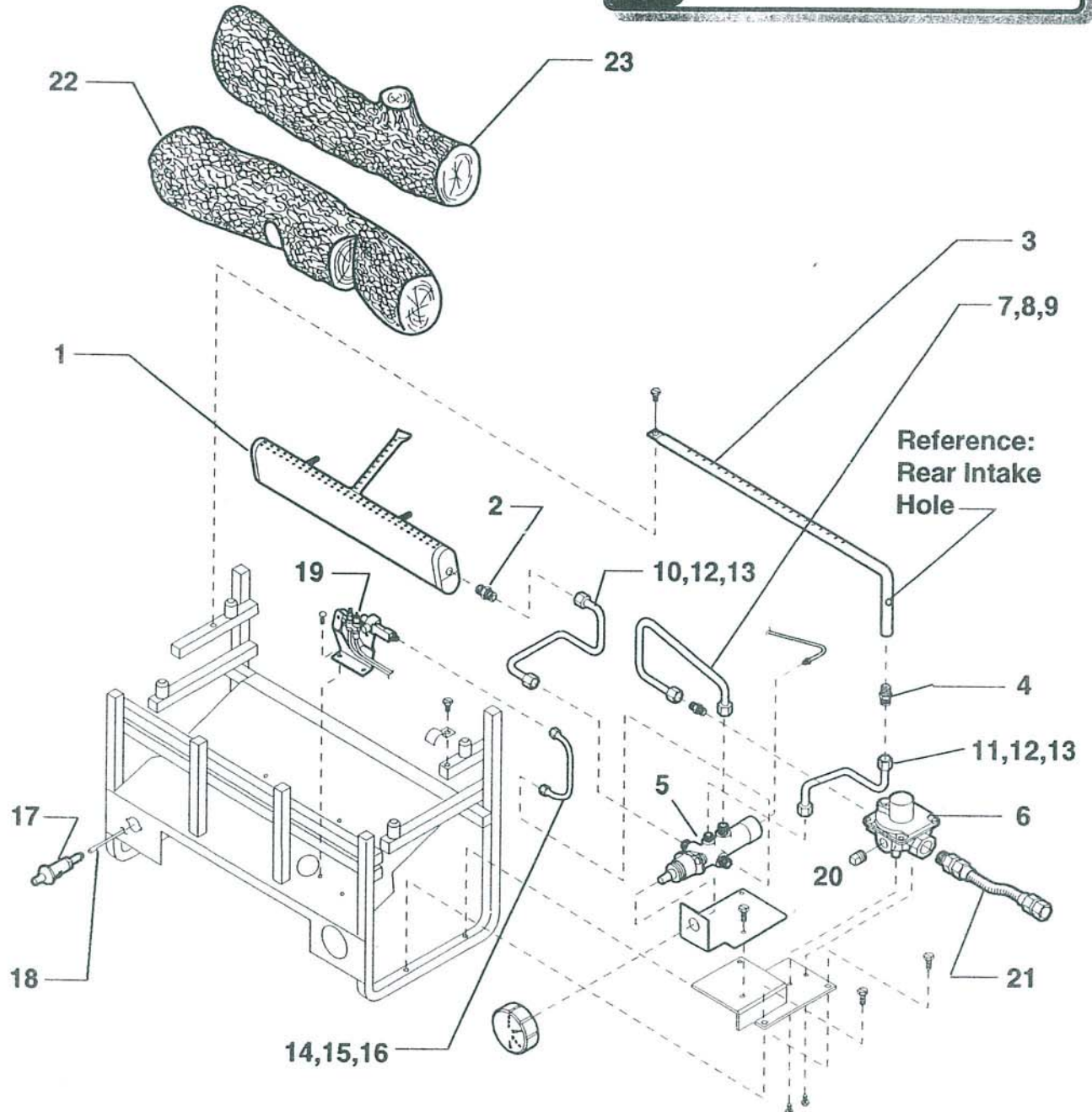

DF32T-STAT CONTROL PARTS LISTS

ITEM	DESCRIPTION	QTY	NATURAL GAS	PROPANE
1	Burner Front	1	14D0512	14D0512
2	Injector Front	1	00K0913	00K0915
3	Burner Rear	1	13B0531	13B0532
4	Injector Rear	1	15D0552	15D0550
5	Valve Control T-stat	1	11V0701	11V0701
6	Screw Modulating (Min Flow)	1	945624	945618
7	Valve Pressure Regulator	1	18D0351	18D0352
8	Tube 5/16 Regulator/Valve	1	15D0315	15D0315
9	Nut 5/16 Tube	2	00K0917	00K0917
10	Ferrule 5/16 Tube	2	00K0918	00K0918
11	Tube 1/4 Valve/Front Burner	1	15D0314	15D0314
12	Tube 1/4 Valve/Rear Burner	1	15D0313	15D0313
13	Nut 1/4 Tube	4	00F0079	00F0079
14	Ferrule 1/4 Tube	4	00F0080	00F0080
15	Tube 3/16 Valve/ODS Pilot	1	15D0311	15D0311
16	Nut 3/16 Tube	1	00F0077	00F0077
17	Ferrule 3/16 Tube	1	00F0078	00F0078
18	Reverse Flare Nut 3/16 Tube	1	11V0314	11V0314
19	Piezo Ignitor	1	14D0503	14D0503
20	Wire Piezo	1	00K0632	00K0632
21	ODS Pilot Assembly	1	15D1013	15D1022
22	Fitting 3/8 NPT x 5/16 Tube	2	11V0313	11V0313
23	Fitting 3/8 NPT x 1/4 Tube	2	11V0312	11V0312
24	Plug Pipe 1/8 NPT	1	00F0092	00F0092
25	Flex Tube with Fittings	1	20H0022	20H0022
Log Set, Golden Oak				
26	Front Log	1	15D0905	15D0905
27	Rear Log	1	15D0906	15D0906
Log Set, Split Oak				
26	Front Log	1	15D2906	15D2906
27	Rear Log	1	15D2907	15D2907

DF32T-STAT CONTROL ILLUSTRATION

WARNING

Failure to position the parts in accordance with these diagrams or failure to use only parts specifically approved with this heater may result in property damage or personal injury.

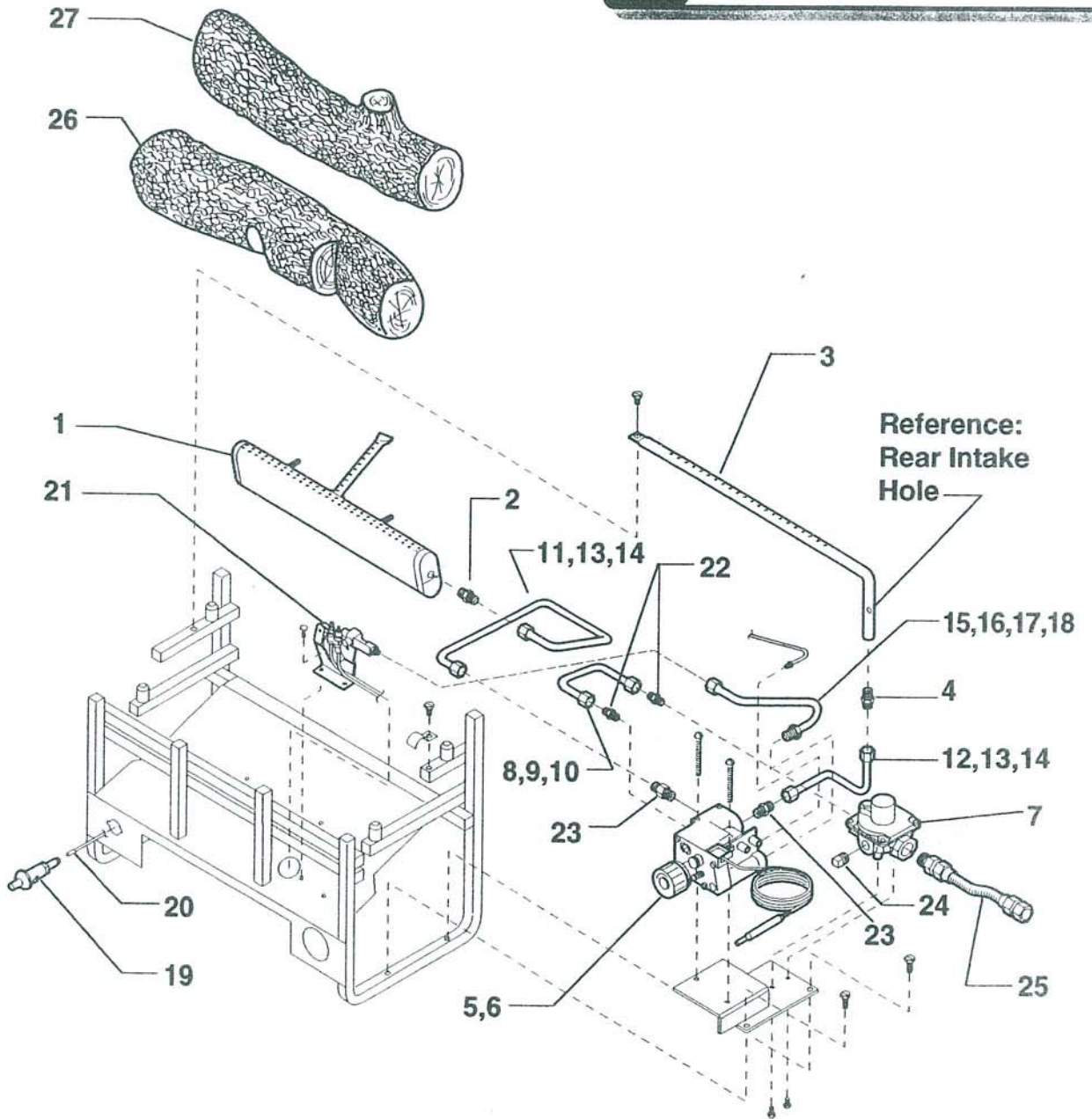

TROUBLESHOOTING

WARNING

Turn off and let cool before servicing. Only a qualified service person should service and repair heater.

NOTE: All troubleshooting items are listed in order of operation.

OBSERVED PROBLEM	POSSIBLE CAUSE	REMEDY
When ignitor button is pressed, there is no spark at ODS/pilot.	<ol style="list-style-type: none">1. Ignitor electrode positioned wrong2. Ignitor electrode is broken.3. Ignitor electrode not connected to ignitor cable.4. Ignitor cable pinched or wet. Keep ignitor cable dry5. Piezo ignitor nut is loose.6. Broken ignitor cable.7. Bad piezo ignitor.	<ol style="list-style-type: none">1. Replace ignitor.2. Replace ignitor.3. Reconnect ignitor cable.4. Free ignitor cable if pinched by any metal or tubing.5. Tighten nut.6. Replace ignitor cable.7. Replace piezo ignitor.
Appliance produces unwanted odors.	<ol style="list-style-type: none">1. Appliance burning vapors from paint, hair spray, glues, etc.2. Gas leak.	<ol style="list-style-type: none">1. Ventilate room. Stop using odor-causing products while heater is running.2. Locate and correct all leaks.
Appliance shuts off in use.	<ol style="list-style-type: none">1. Not enough fresh air is available for ODS/pilot to operate.2. Low line pressure.3. ODS/pilot is partially clogged.	<ol style="list-style-type: none">1. Open window and/or door ventilation2. Contact local gas company.3. Clean ODS/pilot.
Gas odor even when control knob is in OFF position.	<ol style="list-style-type: none">1. Gas leak.2. Control valve defective.	<ol style="list-style-type: none">1. Locate and correct all leaks.2. Replace control valve.
When ignitor button is pressed, there is spark at ODS/pilot, but no ignition.	<ol style="list-style-type: none">1. Gas supply turned off or manual shutoff valve closed.2. Control knob not in PILOT position.3. Control knob not pressed in while in PILOT position.4. Air in gas lines when installed.5. ODS/pilot is clogged.6. Gas regulator setting is not correct.	<ol style="list-style-type: none">1. Turn on gas supply or open manual shutoff valve.2. Turn control knob while in PILOT position.3. Press in control knob while in PILOT position.4. Continue holding down control knob. Repeat igniting operation until air is removed.5. Replace ODS/pilot assembly or get it serviced.6. Replace gas regulator.
ODS/pilot lights, but flame goes out when control knob is released.	<ol style="list-style-type: none">1. Control knob not fully pressed in.2. Control knob not pressed in long enough.3. Manual shutoff valve not fully open.	<ol style="list-style-type: none">1. Press in control knob fully.2. After ODS/pilot lights, keep control knob pressed in 30 seconds.3. Fully open manual shutoff valve.

OBSERVED PROBLEM	POSSIBLE CAUSE	REMEDY
	<ol style="list-style-type: none"> 4. Thermocouple connection loose at valve. 5. Pilot flame not touching thermocouple, which allows thermocouple to cool, causing pilot flame to go out. This problem could be caused by one or both of the following; <ol style="list-style-type: none"> A) Low gas pressure B) Dirty or partially clogged ODS/pilot. 6. Thermocouple damaged. 7. Control valve damaged. 	<ol style="list-style-type: none"> 4. Hand tighten until snug, then tighten 1/4 turn more. 5. Contact local gas company. 6. Replace thermocouple. 7. Replace control valve.
One or both burners do not light after ODS/Pilot is lit.	<ol style="list-style-type: none"> 1. Burner orifice is clogged. 2. Burner orifice diameter is too small. 3. Inlet gas pressure is too low. 	<ol style="list-style-type: none"> 1. Clean burner or replace light burner orifice. 2. Replace burner orifice. 3. Contact qualified service person.
Delayed ignition of burner.	<ol style="list-style-type: none"> 1. Manifold pressure is too low. 2. Burner orifice is clogged. 	<ol style="list-style-type: none"> 1. Contact local gas company 2. Clean burner or replace burner orifice.
Burner backfiring during combustion.	<ol style="list-style-type: none"> 1. Burner orifice is clogged or damaged. 2. Burner is damaged. 3. Gas regulator defective 	<ol style="list-style-type: none"> 1. Clean burner or replace burner orifice. 2. Replace Burner. 3. Replace gas regulator.
Slight smoke or odor during initial operation.	<ol style="list-style-type: none"> 1. Vapors from paint or curing process of logs. 	<ol style="list-style-type: none"> 1. Problem will stop after a few hours of operation. Run the heater with the damper open if you have one or open a window for the first few hours.
Logs appear to smoke (after initial operation).		<ol style="list-style-type: none"> 1. Log heater is intended to be smokeless. Turn off heater and call qualified service person.
Heater produces a whistling noise when burner is lit.	<ol style="list-style-type: none"> 1. Turning control knob to HI position when burner is cold. 2. Air in gas line. 3. Dirty or partially clogged burner orifice. 	<ol style="list-style-type: none"> 1. Turn control knob to LO position and let warm up for a minute. 2. Operate burner until air is removed from line. Have gas line checked by local gas company. 3. Clean burner or replace burner orifice.
No Gas to Pilot	<ol style="list-style-type: none"> 1. LP regulator shut down due to inlet pressure being too high 	<ol style="list-style-type: none"> 1. Verify LP tank regulator is installed and set at 11 to 13 inches w.c. 2. Replace LP regulator on heater.

LIMITED WARRANTY POLICY

Monessen Hearth Systems, Inc., warrants this unvented gas heater for a period of one year, logs and burners for five years, from date of purchase against defects in material or workmanship. This warranty covers only the cost of defective parts and applies only to the original consumer purchaser. The replacement of defective parts by Monessen Hearth Systems Inc., will be without charge. This warranty does not extend to (1) heater damage by accident, neglect, misuse, abuse, alteration, negligence of others, including the installation thereof by unqualified installers, (2) the costs of removal, reinstallation or transportation of defective parts on the heater, or (3) incidental or consequential damage.

THIS WARRANTY IS EXPRESSLY IN LIEU OF OTHER WARRANTIES, EXPRESS OR IMPLIED, INCLUDING THE WARRANTY OF MERCHANTABILITY OF FITNESS FOR PURPOSE AND OF ALL OTHER OBLIGATIONS OR LIABILITIES, MONESSEN HEARTH SYSTEMS, INC., DOES NOT ASSUME FOR IT, ANY OTHER OBLIGATION OR LIABILITY IN CONNECTION WITH THE SALE OR USE OF THIS HEATER.

The heater must be installed by a qualified installer in accordance with the instructions furnished with the unit. The defective heater should be returned at your expense to the dealer from whom the product was purchased or an authorized service agent. Any products presented for warranty repair must be accompanied by a dated proof of purchase and date of purchase. Since some states do not allow the exclusion on limitation of incidental or consequential damages, or on how long an implied warranty lasts, the above limitations may not apply to you.

If you would like to communicate with the manufacturer, write to:

**Monessen Hearth Systems
Attention: Customer Service
P.O. Box 1018
793 Lemons Mill Road
Georgetown, Kentucky 40324**

or:

**Phone: (800) 867-0454
Fax: (800) 863-9548**

Monessen Hearth Systems welcomes your comments and suggestions.