

This Owner's Manual is provided and hosted by [Appliance Factory Parts](http://ApplianceFactoryParts.com).

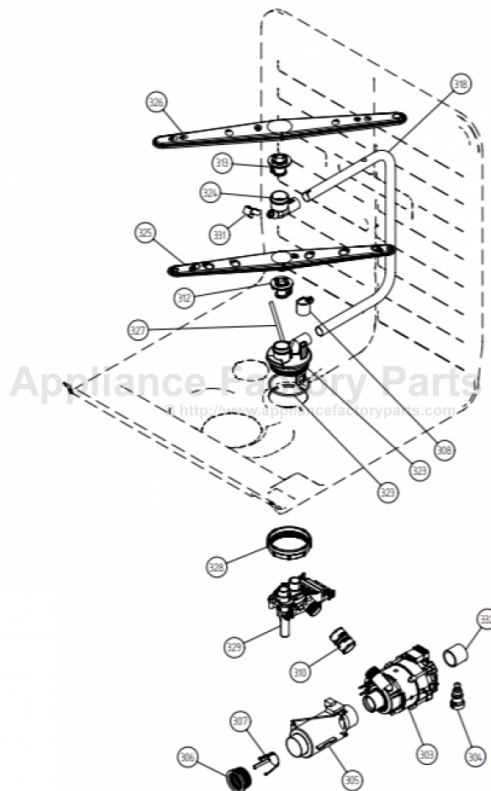

ASKO D3120SS Owner's Manual

[Shop genuine replacement parts for ASKO D3120SS](#)



[Find Your ASKO Dishwasher Parts - Select From 210 Models](#)

----- Manual continues below -----

Use & Care Guide

Dishwasher

ASKO D3120

Dear ASKO-customer;

Congratulations on your excellent product choice and welcome to the Asko family. A global family with its roots in Scandinavia.

Cleaning results, design, environmental impact on nature and home, user-friendliness, low consumption of time, energy and water; a long life span, reliability... Good appliances should include all of these. And this is what we try to give you.

When you buy an ASKO product, we want you to feel assured that the inside is as good as the outside and that the ethics and morals on which we built this machine are just as high as the quality and performance you get from it. That is what Scandinavian quality is all about.

In order to get the best possible results from your machine and all its functions, please read this Use and Care Guide before using the machine for the first time. And if you have any questions, please do not hesitate to call us or contact us via our web site.

Best regards from Scandinavia and the people at Asko.

Contents

| | | |
|--|--------------|--|
| Contents | Page | |
| Before doing your first wash | 5 | |
| Read the directions of use | | |
| Take care with certain materials | | |
| Check the door | | |
| Check water hardness level | | |
| Machines with water softener | | |
| Safety | 6 | |
| General | | |
| Winter storage/Transport | | |
| Overfill protection | | |
| Cleaning | | |
| Packaging materials | | |
| Scrapping | | |
| Child safety | 7 | |
| Child-safe dishwashing | | |
| Child safety lock | | |
| Protect your children! Dishwasher detergent is corrosive | | |
| Parts of the dishwasher | 8 | |
| Technical information | 8 | |
| Baskets | 9 | |
| Control panel | 10 | |
| Dispenser | 10 | |
| Basic Course | 11-12 | |
| Load the baskets correctly | | |
| Dispense dishwasher detergent | | |
| Select program | | |
| Options | 13 | |
| High temperature | | |
| Extra dry | | |
| Press start | | |
| Changing options | | |
| | | Do you want to load more dishes? If the machine is switched off with the main switch After dishwashing |
| | | Eco-dishwashing 14 |
| | | Only perform washes with a full machine |
| | | Do not rinse before dishwashing |
| | | Choose environmentally-friendly dishwasher detergent |
| | | Fragile dishes 15 |
| | | Fragile decoration |
| | | Crystal/glass |
| | | Silver |
| | | Cutlery with glued handles |
| | | Wood |
| | | Aluminium |
| | | Plastic |
| | | Protect plastic goods |
| | | Standard program 16-17 |
| | | Cleaning 18-19 |
| | | Coarse filter |
| | | Fine filter |
| | | Drain pump |
| | | Spray arms |
| | | Door |
| | | Rinse aid 20 |
| | | Pour in rinse aid |
| | | Select dosage |
| | | Salt 21 |
| | | Pour in salt |
| | | Settings 22 |
| | | Setting water hardness |
| | | Fault indications 23 |





| | | | |
|--|--------------|--------------------------------|-----------|
| Troubleshooting | 24-26 | Setting water hardness | |
| The dishes are not clean | | Service & guarantee | 33 |
| Stains or a film on the china | | Own comments | 34 |
| The china has a whitish-blue sticky film | | Search words | 35 |
| Stains on stainless steel or silver | | Quick Guide | 36 |
| Stains which remain after dishwashing | | | |
| Rattling sounds during dishwashing | | | |
| The machine will not start | | | |
| Water remains in the machine | | | |
| Overfilling/leakage | | | |
| Bad odour in the machine | | | |
| Performance information | 27 | | |
| Installation | 28-32 | | |
| Suggestions on positioning the dishwasher | | | |
| A. Built-in | | | |
| B. Freestanding | | | |
| C. Semi-freestanding | | | |
| Connection to water supply | | | |
| Connection to electricity | | | |
| Drainage connection | | | |
| Positioning the machine | | | |
| A. Adjusting machines with six feet (freestanding dishwasher) | | | |
| B. Adjusting machines with three or four feet | | | |
| C. Adjusting dish washers with adjustable foot | | | |
| Installing the plinth (Only with kick-plate as accessory) | | | |
| Screw the dishwasher into place | | | |
| Fitting fixed kick-plate | | | |
| Fitting strip seal (on floor plinth covering plate) | | | |
| NB! Not all models | | | |

Before doing your first wash

Read the directions of use

Read the directions of use before starting to use your machine, especially the Safety, Child Safety and Basic Course sections.

Take care with certain materials

Read the section 'Fragile dishes' before washing china with unglazed decoration or other household goods made of plastic, wood or crystal requiring careful treatment.

Check the door

Check that the door of the dishwasher fits properly: open the door a little and let it go. Does it stay exactly where you released it? If not, you should check the installation instructions or consult the installer.

Check water hardness level

Phone your local Water Board to check the water hardness in your area. This is important when dispensing dishwasher detergent and rinse aid.

Machine with water softener

Once you know the water hardness, you can set the water softener, see Settings. Before you start dishwashing, you must also fill with salt, see Salt.

Safety

General

- Read and keep the directions for use!
- Installation of water, drainage and electricity must be carried out by a qualified professional.
- Do not use the dishwasher for any purposes other than those stated in these directions for use.
- Do not load the dishwasher door or the dishwasher baskets with anything other than dishes.
- Only use **dishwasher** detergent!
- Place knives and other sharp objects so that they cannot cause injury to people or damage the dishwasher.

Never put dishes containing solvent residue in the machine due to risk of explosion. Neither may dishes containing ashes, wax or lubricating grease be washed in the dishwasher.

Winter storage/Transport

Store the machine away from frost. Avoid long journeys in extreme cold. Transport the machine in an upright position or lying on its back.

Overfill protection

The overfill protection starts pumping out water and closes off the water intake if the machine's water level exceeds the normal level. If the overfill protector starts up, shut off the water supply and phone for service. See also 'Troubleshooting' on pages 23-25.

Cleaning

Only use a slightly damp cloth for cleaning around the edge of the door. Do not use a spray bottle! Water can penetrate into the lock and come into contact with the electrical components.

Packaging materials

Sort at source in accordance with the recommendations of your local authority.

Scrapping

When the time comes for the machine to be scrapped, it should immediately be rendered unusable. Remove the plug and cut off the lead as short as possible.

Contact the refuse collection department or your local authority for information on the correct way to dispose of the dishwasher! The dishwasher is manufactured and labelled for recycling.

Child safety!



KidLock™



KidSAFE™

Child-safe dishwashing

- Always close the door and start the program immediately once dishwasher detergent has been added.
- Keep children away from the dishwasher when it is open. There might be the remains of dishwasher detergent present!
- Do not allow children to use or play with the dishwasher. Always take particular care when the door is open.

Child safety lock

A child safety lock is fitted to prevent children from opening the door of the dishwasher.

1. Activate the child safety lock by pressing in the door latch and turning the screw slot (up in the left hand corner) to the vertical position with a screwdriver.
2. To open the door, you must slide the white plastic latch (illustrated below) to the left at the same time as pressing the catch upwards.

Reset by returning the screw slot to the horizontal position.

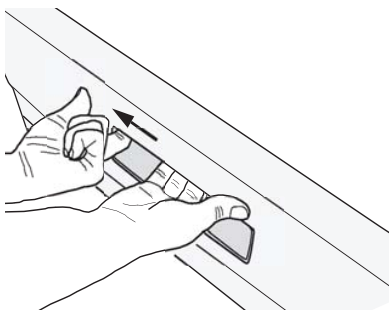

Closed



Open

Protect your children!



- Dishwasher detergent is corrosive!

WARNING: Dishwasher detergents are strongly alkaline. They can be extremely dangerous if swallowed. Avoid contact with skin and eyes and keep children away from the dishwasher when the door is open.

Check that the detergent receptacle is empty after completion of the wash cycle.

Store dishwasher detergent and rinse aid out of the reach of children! Should dishwasher detergent be swallowed, immediately drink one or two glasses of milk or water. Do not attempt to induce vomiting. Contact a doctor! Should dishwasher detergent come into contact with the eyes, rinse (for at least 15 minutes) with copious amounts of water.

Parts of the dishwasher*

1. Knife basket
2. Upper basket
3. Spray arms
4. Lower basket
5. Cutlery basket
6. Rinse aid dispenser
7. Dishwasher detergent compartment
8. Main switch
9. Program panel
10. Filter
11. Type plate

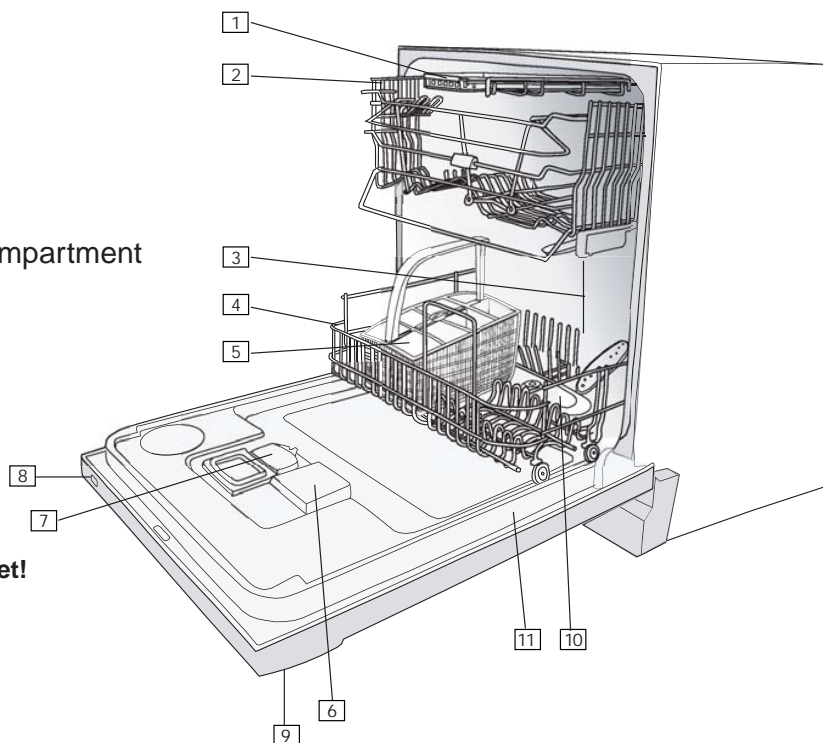

* Details may differ depending on model and market!

Technical information

| | |
|----------------|---|
| Height | 820-870 mm |
| Width | 596 mm |
| Depth | 550 mm**** |
| Weight | 48 kg/51 kg with water softener* |
| Capacity** | 14 place settings |
| Water pressure | 0.03-1.0 MPa (0.3–10 kp/cm ²) |
| Connection | 1-phase, 230 V, 50Hz 10/10A*** |
| Max output | 1900 W*** |
| Accessories | Work surface, Side panels, Anti-tilt |

* Details may differ depending on model and market!

**In accordance with standard, AS/NZS 2007

***See type plate.

****Without fitted wooden door.

Baskets*



FLEXIRACKS™

Upper basket

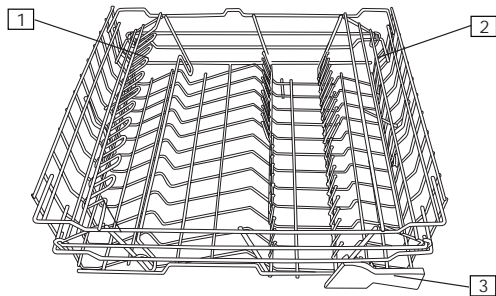

1. Wine glass shelf
2. Cup rack
3. Knife stop
4. Cutlery basket with door and folding handle

Lower basket

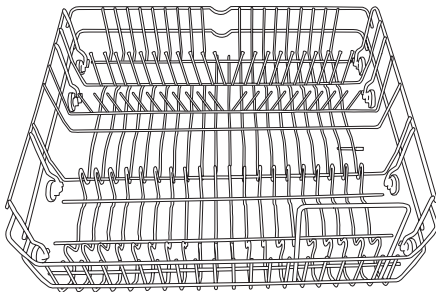

Cutlery basket

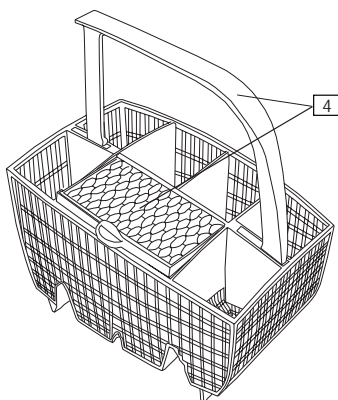

***Details may differ depending on the model and market!**

Control panel

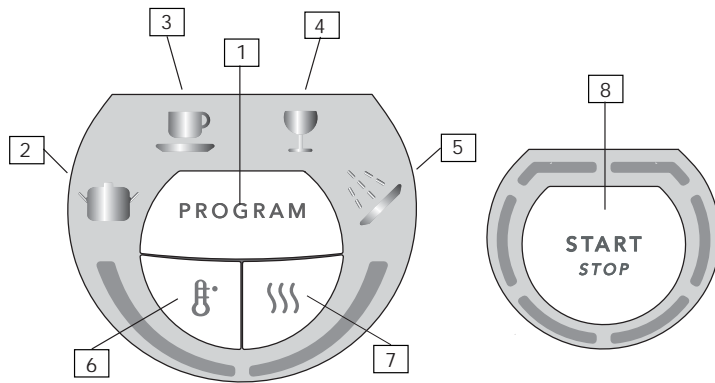

- 1. Program selector
- 2. Heavy wash
- 3. Normal wash
- 4. Quick wash

- 5. Rinse & Hold
- 6. High temperature
- 7. Extra dry
- 8. Start/stop

Dispenser

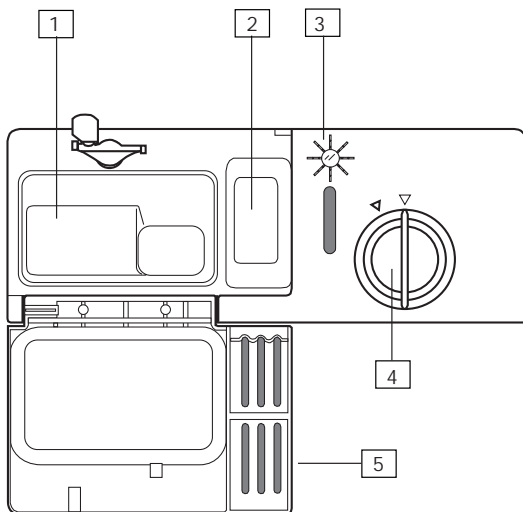

- 1. Compartment for main wash dishwasher detergent
- 2. Compartment for pre-wash detergent
- 3. Refill indicator rinse aid
- 4. Rinse aid cover
- 5. Detergent compartment cover

Below are step by step instructions to help you achieve the best possible dishwashing results.

1 Load the baskets correctly!

Your dishwasher is equipped with Super Cleaning System™. It is not necessary to rinse the dishes before washing.

Simply remove large food particles and debris. Convenient and environmentally friendly!

Place glasses, cups, bowls, side plates and dishes in the upper basket.

NB!

Ensure that all soiled surfaces face inwards or downwards!

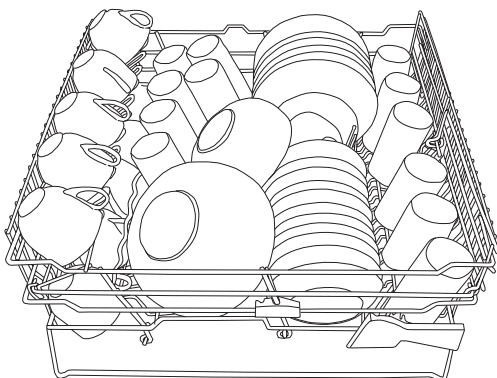

Place dinner plates, side plates, serving dishes, saucepans and cutlery (in the cutlery basket) in the lower basket.

Stand the cutlery with handles downward and as spread out as possible. Ensure that spoons are not resting inside each other.

Do not put cutlery made of different materials, e.g. silver and stainless steel, in the same compartment (risk of stains).

Check that the spray arms are able to move freely.

See Fragile dishes, if you want to wash articles that may be fragile.

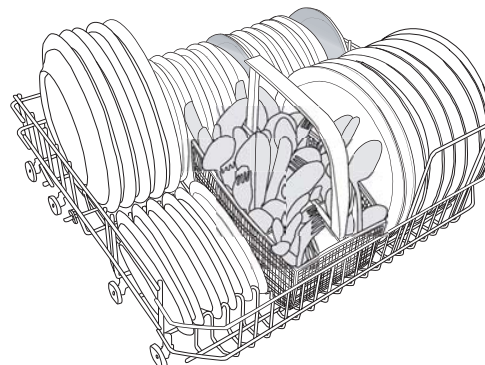

2 Detergent dosage

Detergent should be dispensed in accordance with the water's hardness level.

Follow the dosage instructions on the detergent package. If your dishwasher is fitted with a water softener, dispense as for soft water.

Pour the dishwasher detergent into the dishwasher detergent compartment. There is one compartment for pre-wash and one for main wash, see Dispenser. Phone the dishwasher detergent manufacturer if you have any questions regarding the detergent.

CAUTION!



Protect your children!

- Dishwasher detergent is corrosive!

NB!

Only use dishwasher detergent

Detergent for washing by hand cannot be used as the build-up of foam impedes the machine's performance.





3 Switch on the main switch

 and close the door

4 Select program

Select a program by pressing the program selector one or more times until the required program is displayed.

Heavy wash

The Heavy Wash program should be used for heavily soiled dishes, e.g. saucepans, pots and gratin dishes. If there is still space in the machine after loading such items, you can add plates etc.

Normal wash

Used for washing normally soiled dishes such as plates, serving dishes, cups and glasses, etc.

Quick wash

Select Quick Wash if the dishes are very lightly soiled. This program is used for very lightly soiled glass and china, e.g. coffee cups.

Rinse & Hold

For rinsing the dishes while waiting for the machine to be filled.

If you wish to use further options continue to point 5. Otherwise you can now start the dishwasher, see point 6.

Options

5 Select options

To select an option, press one of the option buttons.

High temperature

With the temperature option button you can select the wash temperature yourself. You can vary the temperatures as follows:

| | |
|-------------|----------|
| Heavy wash: | 70°/55°C |
| Normal wash | 45°/50°C |
| Quick wash: | 30°/50°C |

The field next to the button lights up if you have selected the **higher** temperature. The selection remains until changed.

Extra dry

If you require a better drying result, press the option button Drying selection. The field next to the button lights up. Should you require a program without Extra drying – press again and the light will go out. Cannot be used in the Rinse & Hold program.

6 Press Start

The dishwasher will now start. It manages the entire wash automatically. Ensure that the door is properly closed or the machine will not start. The circle around the Start/Stop button lights up progressively as it works through the program.

Changing options

If you want to change program after having started the dishwasher, press the Start/Stop button for three seconds. Then select a new program and press the Start/Stop button.

Do you want to load more dishes?

Open the door slowly; the machine stops automatically, put in the dishes, close the door and the dishwasher will continue from where it left off.

If the machine is switched off from the main switch

(or in the event of a power cut) before the washing program has been completed, the interrupted program will continue when power comes back on.

7 After dishwashing

When the dishwasher has finished, the whole circle around the Start/Stop button will be lit up. It will then only consume standing current. Should you wish to disconnect the current completely, just switch off at the main switch. Turn off the water tap if the machine is not to be used for an extended period, e.g. during holidays.

Advice!

For quicker drying allow the door to stand slightly ajar.

Eco-dishwashing

Only perform washes with a full machine

Put off dishwashing until the machine is full, and in this way you will save energy.

Do not rinse before dishwashing

Thanks to the dishwasher's Super Cleaning System™ you do not need to rinse the dishes under running water before loading them into the machine.

Choose environmentally-friendly dishwasher detergent

Read environmental declarations on the package!

Fragile dishes

A number of household goods are not suitable for machine washing. There can be many reasons for this. Certain materials cannot withstand intense heat, others can be damaged by the dishwasher detergent.

Fragile decoration

China with decoration on top of the glaze (the article has a rough feel) should not be machine washed.

Crystal/ glass

Place the articles so that they do not knock together during the wash. Antique and very fragile items should not be machine washed.

Silver

Silver and stainless steel items should not come into contact with each other as the silver can discolour.

Cutlery with glued handles

Certain types of adhesive cannot withstand machine washing. In such cases the handles can come loose.

Wood

Wooden articles should only be machine washed if they are labelled as dishwasher proof.

Aluminium

Aluminium can be dulled by machine washing. However, good quality aluminium saucepans can be machine washed, although a reduction in lustre should be expected.









Plastic

Certain types of plastic cannot withstand the high temperature generated in machine dishwashing.

To protect plastic articles

Select either the Normal wash or the Quick wash program. Not Heavy Wash.

Standard program

| Program | | | Tested program | | |
|------------------------------|---|---|---|---|---|
| Press |  |  |  |  |  |
| Program | Heavy wash | Heavy wash | Normal wash | Quick wash | Quick wash |
| Options |   | -- | -- |  | -- |
| | | | | | |
| How the machine works | | | | | |
| Temperature | 70 °C | 55 °C | 45 °C | 30 °C | 30 °C |
| Pre-wash with SCS* (number) | 2 | 2 | 1 | -- | -- |
| Main wash (number) | 1 | 1 | 1 | 1 | 1 |
| Rinse & Dry (number) | 3 | 3 | 2 | 2 | 2 |
| Final rinse | 70 °C | 60 °C | 60 °C | 60 °C | -- |
| Fan | -- | -- | -- | -- | -- |
| Consumption values | | | | | |
| 1. Wash time (approx. min)** | 160 | 150 | -- | 55 | 15 |
| 1. Energy (approx. kWh) | 1,1 | 0,8 | -- | 0,3 | 0,1 |
| 2. Wash time (approx. min)** | 185 | 155 | 95 | 70 | 20 |
| 2. Energy (approx. kWh) | 1,8 | 1,2 | 1,0 | 0,7 | 0,2 |
| Water consumption (litres) | 20 | 20 | 14 | 9,5 | 9,5 |

* SCS = Super Cleaning System™.

** All quoted times are only indicative, fluctuations may occur. Due to water temperature, water pressure, variations in voltage etc.

1. Hot water connection approx. 60°C.

2. Cold water connection approx. 15°C.

Standard program

| | | | | | |
|------------------------------|---|--|--|--|--|
| Program | | | | | |
| Press |  | | | | |
| Program | Rinse & Hold | | | | |
| Options | -- | | | | |
| | | | | | |
| How the machine works | | | | | |
| Temperature | -- | | | | |
| Pre-wash with SCS* (number) | -- | | | | |
| Main wash (number) | -- | | | | |
| Rinse & Dry (number) | -- | | | | |
| Final rinse | 1 | | | | |
| Fan | -- | | | | |
| Consumption values | | | | | |
| 1. Wash time (approx. min)** | 4 | | | | |
| 1. Energy (approx. kWh) | 0,01 | | | | |
| 2. Wash time (approx. min)** | 4 | | | | |
| 2. Energy (approx. kWh) | 0,01 | | | | |
| Water consumption (litres) | 3,0 | | | | |

* SCS = Super Cleaning System™.

** All quoted times are only indicative, fluctuations may occur. Due to water temperature, water pressure, variations in voltage etc.

1. Hot water connection approx. 60°C.

2. Cold water connection approx. 15°C.

Cleaning

Cleaning

The dishwasher's inner container is made of stainless steel and is kept clean through normal use. However, if you have calciferous (hard) water, lime deposits can form in the dishwasher. In this case, run a normal wash program with two tablespoons of citric acid in the dishwasher detergent compartment.

Coarse filter

The coarse filter collects large food particles which cannot get past the outflow pump. Lift out and empty the coarse filter as necessary. Don't forget to replace it!

Fine filter

The residue which collects on the fine filter is automatically rinsed off with each wash. The fine filter should still be cleaned once or twice a year.

1. Remove the fine filter by first turning the filter's tubular strainer anti-clockwise and then lifting it straight up with the coarse filter.
2. Clean with a dishwashing brush. Ensure that the edges are properly sealed when replacing the fine filter.

Drain pump

The pump can be accessed from the inside of the machine.

1. Always remove the plug from the wall socket before you clean the pump.
2. Remove the coarse screen first by pressing together the two lugs and pulling the screen upwards.
3. Now loosen the tubular part of the screen by turning it anticlockwise and removing the fine screen.
4. Finally remove the small adapter to the left of the bottom drain.
5. It's possible, by inserting your finger in the hole, to turn the pump impeller and remove any blockage.
6. Refit the adapter and screens.
7. Insert the plug in the wall socket.

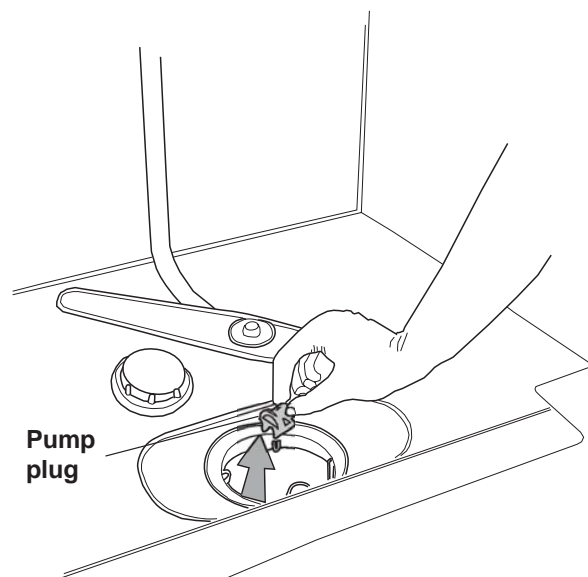
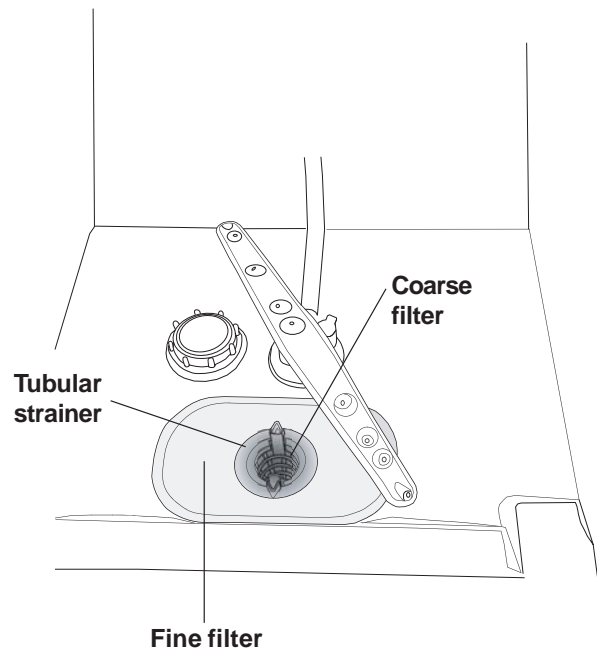

If you still cannot start the machine and a humming noise can be heard, then the overfilling protection has been activated.

- Shutoff the water
- Remove the plug from the wall socket
- Call Service

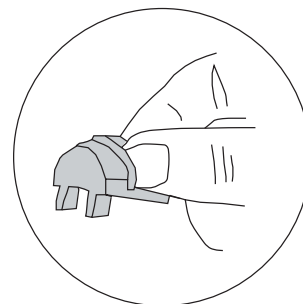

CAUTION!



Do not forget to replace the pump plug.

Spray arms

The holes and bearings can occasionally become clogged.

1. Pull the lower spray arm straight up to release it.
2. Scrape away the debris with a needle or similar. The spray arms also have holes on the underside.

To release the upper spray arm, the upper basket must be removed.

3. Pull out the basket and turn the basket stop outwards on both rails (see picture). The basket can now be removed.
4. Remove the upper spray arm in the same way as the lower arm and clean it.

Door

When cleaning the edge around the door, use only a slightly damp cloth, possibly with a little detergent. Do not use a spray bottle or similar around the door catch. This is to ensure that water does not penetrate into the door catch and come into contact with the electrical components.

CAUTION!



Do not use a spray bottle or similar around the door catch.

Tip!

In order to prevent bad odours in the dishwasher, clean the strips and corners with a dish brush and low-lather detergent.

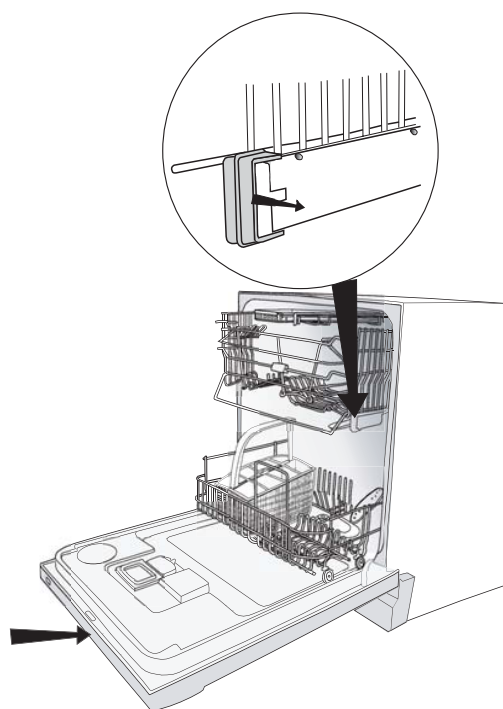

Rinse aid

Pour in rinse aid

Rinse aid, helps quicken the drying process. There is a refill indicator in the middle of the dispenser (see picture). If the refill indicator is totally black, there is sufficient rinse aid. However, if the indicator has a more transparent appearance, you need to top up with rinse aid.

1. Turn and lift up the cover of the rinse aid compartment to the right of the dispenser. This is where you top up and set the amount of rinse aid to be dispensed in each wash.
2. Fill until the indicator is totally black and change the dosage as follows if required. Do not forget to close the cover.

Select dosage

The dispenser is usually set at 1= soft water. However, depending on the water hardness, it may be necessary to change the dosage.

Open the rinse aid cover . Here you will find the dispenser's adjustment dial. Settings 1-6: the harder the water, the higher the dosage.

Where the water hardness exceeds 10-12 °dH you should use rinse aid with citric acid (acid rinse aid) if the dishwasher does not have a water softening filter. If the dishwasher has a water softening filter, dispense as for soft water.

Too much rinse aid can lead to the build-up of foam. If your water is particularly soft, you can dilute the rinse aid (1 part rinse aid, 1 part water).

Too much rinse aid can cause streaks on the dishes, while too little can result in water stains.

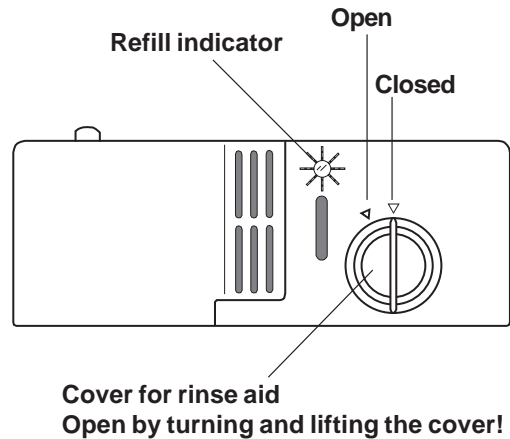

Salt

(applies to dishwashers with water softeners)

Pour in salt

Before using a dishwasher with a water softening filter, you must fill the salt compartment with salt. Use coarse salt or special salt for dishwashers.

It is best to fill with salt when you are about to do a wash, as the dishwasher needs to be rinsed out immediately after filling.

Proceed as follows the first time:

1. First unscrew the cover as illustrated.
2. Place the funnel, which is supplied with the dishwasher, into the compartment's filler hole. First pour in approximately 1 litre of water.
3. Then fill the compartment with max 1.5 kg salt.
4. Wipe away excess salt so that the cover can be properly screwed into place.
5. Run a Normal wash program so that any salt in the machine is rinsed away.

When the salt runs out, unscrew the cover and fill the compartment with salt. Water is only needed on the first occasion! Wipe clean and screw back in place. Run a Normal wash program so that any salt is rinsed away.

Occasionally check to see if more salt is needed. A green indicator can be seen in the cover of the salt compartment.

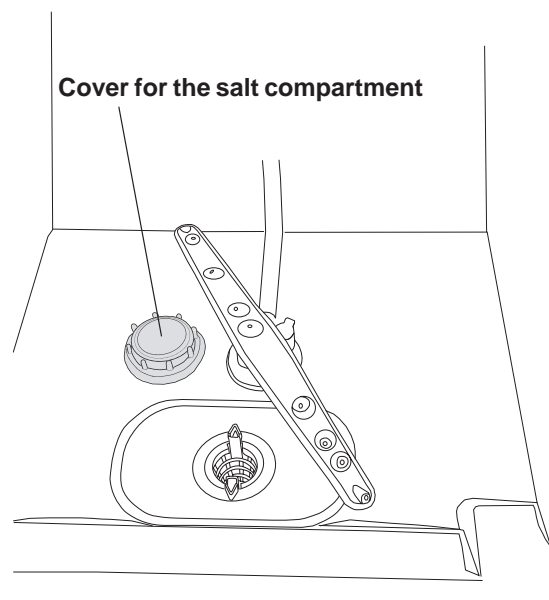

CAUTION!



Never pour dishwasher detergent into the salt compartment. The water softener will be ruined!

Settings

Setting water hardness

If you have a dishwasher with a water softener, you may need to change the setting depending on the water's hardness level. Phone your local Water Board to check the water hardness in your area. The dishwasher is set for low water hardness on delivery.

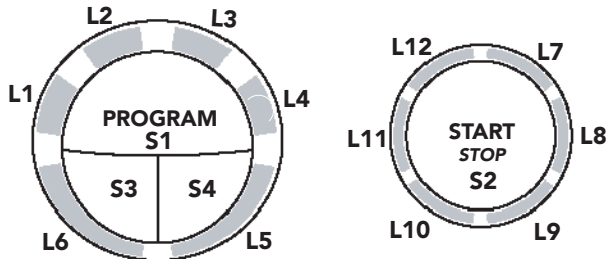

1. Switch off the dishwasher with the main switch.
2. Press the main switch while holding in the Start/Stop button.
3. Release both buttons and the L7 light will flash.
4. Select desired setting (see table below) by pressing repeatedly on the Program button.

| Setting | °dH | °fH |
|--------------------------------------|-----------|-----------|
| All extinguished | 0-5* | 0-9* |
| L1 lit | 6-8 | 9-14 |
| L1, L2 lit | 9-14 | 15-25 |
| L1, L2, L3 lit | 15-19 | 26-34 |
| L1, L2, L3, L4 lit | 20-29 | 35-52 |
| L1, L2, L3, L4, L5, L11 lit | 30-44 | 53-79 |
| L1, L2, L3, L4, L5, L6, L11, L12 lit | 45 and up | 80 and up |

5. Confirm your selection by pressing the Start/Stop button. You now automatically leave the settings menu and the selected setting remains until you want to change it.

Fault indications

| Indication | Type of fault | Action |
|-------------|----------------------------------|---------------|
| L2 flashing | Too much water in the dishwasher | Phone service |

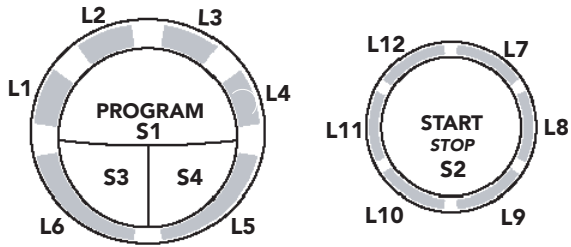

Troubleshooting

Problems

The dishes are not clean.

Possible causes

- The spray arms are not rotating.
- Old dishwasher detergent. NB! Detergent is a perishable.
- Incorrect dosage of detergent.
- Insufficiently powerful dishwashing program.
- Incorrect loading of the dishwasher.
- Glasses and cups have tipped over during the wash.

Action

- Lift off the arms and clean.
- Avoid large packs.
- Dispense according to the level of water hardness.
- Change to a more intensive program.
- Do not cover china with large bowls or similar.
- Load the china securely.

Stains or a film on the china.

- Dishwasher fitted with water softener is leaking salt.
- Incorrectly set water softener.
- Incorrectly set rinse aid dispenser.
- The salt compartment is empty.
- Phosphate-free detergent in combination with hard water.
- Too high a temperature and/or too much detergent can cause etching on (crystal) glass. Unfortunately this cannot be remedied, only prevented!

- Check that the cover of the salt compartment is properly screwed on. Otherwise phone for Service.
- See the chapter on water softeners.
- See the chapter on rinse aid.
- Top up with salt.
- Change detergent.
- Wash (crystal) glass at a low temperature and dispense dishwasher detergent with care. Contact the dishwasher detergent manufacturer.
- Use liquid detergents on fine china.

Problems

The china has a whitish-blue sticky film.

Stains on stainless steel or silver.

Stains which remain after dishwashing.

Rattling sound during dishwashing.

The machine will not start.

To restart the machine, press Start/stop for 3 seconds. Now select a new programme and press Start/stop.

Possible causes

- Too high dosage of rinse aid.

- Certain food remnants such as mustard, mayonnaise, lemon, vinegar, salt and dressings can cause stains on stainless steel if allowed to remain for any length of time. All stainless steel can mark silver if allowed to come into contact during the dishwashing process. Aluminium can also cause stains on dishes.

- Lipstick and tea can be difficult to remove.

- The dishes are not properly loaded or the spray arms are not rotating.

- You have forgotten to switch on the main switch.

- The door is not properly closed.

- A fuse has blown.

- The plug is not plugged in.

- The water tap is off.

- Overfilling/leakage

- A droning sound (drainage pump) can be heard from the machine, this does not stop when the power is switched off using the main power switch.

Action

- Reduce dosage. See the chapter on rinse aid. If the water is very soft, you could try diluting the rinse aid (1 part rinse aid, 1 part water).

- Rinse off food residue of this type if you do not intend to start the dishwasher immediately.

- Separate your cutlery into various compartments in the basket. Make sure silver and stainless steel are not together.

- Change to a detergent with bleach.

- Check that the china is loaded securely. Spin the spray arms to make sure that they rotate.

- Check

- Check

- Check

- Check

- Check

1. Close the water tap.
2. Pull out the plug.
3. Call a service engineer





Problems

Water remains in the machine.

Possible causes

- Obstruction in the drain hose.
- Kinks in the drain hose.
- The filters are clogged.
- Objects in the drain pump.

Action

- Disconnect the drain hose where it is connected to the sink's water trap. Check that no debris has become stuck. Is the cone-shaped part of the pipe cut so that the diameter is at least 16 mm?
- Check that the hose is free from kinks or sharp bends.
- Clean out the coarse filter, the fine filter and the filter.
- Clean out the drain pump. See chapter on cleaning

Bad odour in the machine

- Dirt along the strips and in corners

- Clean with a dish brush and low-lather detergent.

Performance information

Test dosage

Heavy wash/Normal wash

Main wash 25 gram Standard detergent.
Rinse aid dosage 3.

Energy labelling

Australia:

AS/NZS 2007

Dishwasher program:

Normal wash, 45°C

Program time:

95 minutes.

Connection:

Cold water

Test method noise measurement:

IEC-704-3

Example of dishwasher loading

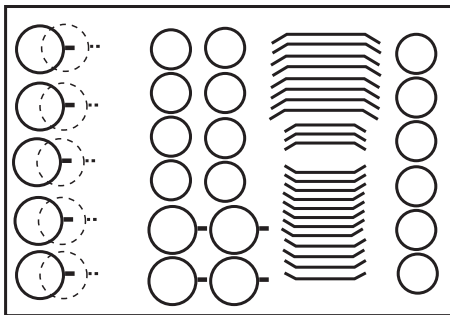

AS/NZS 2007

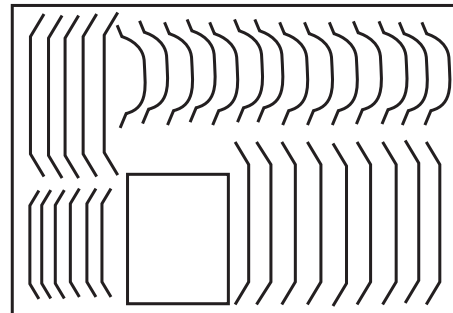

AS/NZS 2007

Technical information

Height:

820-870 mm

Width:

596 mm

Weight:

48 kg*

51 kg with water softener*

Capacity:

14 IEC place settings

Water pressure:

0.03-1.0 MPa

0.3-10 kp/cm² (Bar)

3-100 N/cm²

Connection:

See type plate

Output:

See type plate

*The weight can vary due to varying specifications.

Installation

Suggestions for positioning the dishwasher

The dishwasher can be built in, fully free-standing or semi-free-standing.

CAUTION!



Connection to electricity, water and drainage must be carried out by a suitably qualified person.

A. Built-in

The dishwasher can be built in under a worktop with a working height of 820 - 870 mm. The width measurement must be at least 600 mm. For additional measurements, see picture.

B. Freestanding

A freestanding dishwasher must be fitted with anti-tilt. This comprises two fastening irons which are screwed into place as illustrated.

The dishwasher is then pushed in so that the fastening irons grip onto the rear feet. The dishwasher cannot now tilt in the event a load is placed on the open door. If the dishwasher is to be fully freestanding, both side panels and the work top should be fitted. These accessories can be purchased where you purchased the dishwasher.

C. Semi-free-standing

If the dishwasher is positioned so that either side is visible, a side panel can be fitted. These accessories can be purchased where you purchased the dishwasher.

Built-in installation

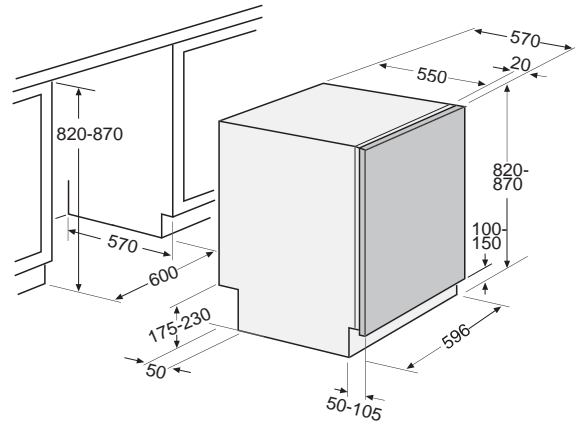

Freestanding installation

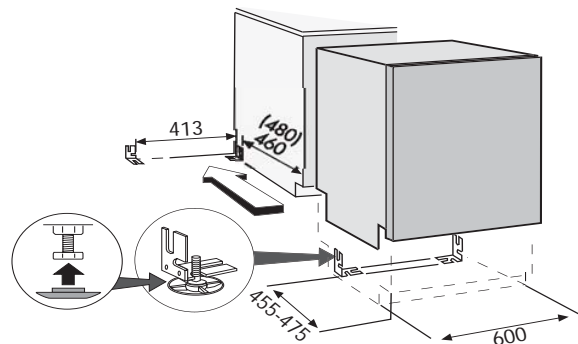

CAUTION!



A fully freestanding dishwasher must be fitted with anti-tilt.

Connection to water supply

There must be a shut-off tap on the water supply pipe. The shut-off tap should be positioned above the work surface or at the front of the sink unit.

The water supply pipe has a connection with a 1/2" or 3/4" internal thread depending on country.

When the installation is complete, the shut-off tap should be opened to allow the pressure to settle for a while and to check that all connections are tight.

Connection to electricity

A dishwasher fitted with a lead and plug must be connected to an earthed socket. Repairs and maintenance affecting safety or performance must be carried out by a qualified professional.

Technical data

See the type plate on the right hand side of the door.

CAUTION!



The lead must be disconnected or the socket voltage-free while the work is carried out!

Connection to drainage

NB!

The hose must be fastened level with the underside of the work surface.

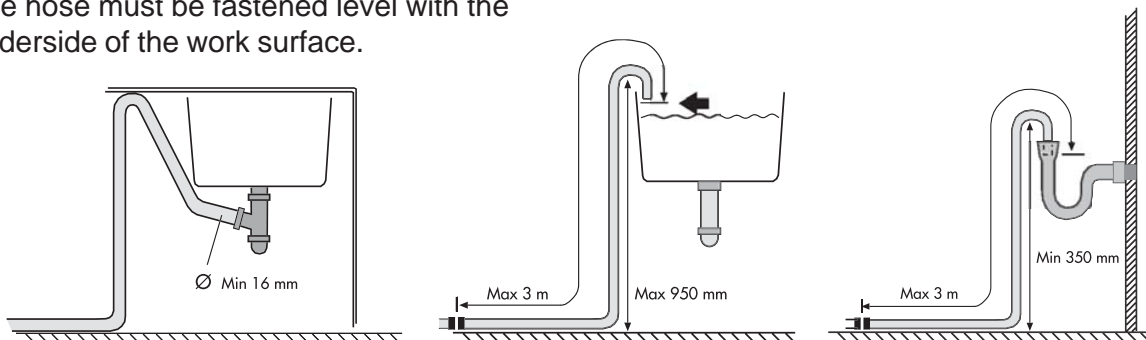

Details may differ depending on the model and the market!

Connection to drainage

The drain hose is routed to a connection nipple at the sink's water trap, as illustrated below. Note that the hose must be fastened level with the underside of the sink unit – otherwise the dishwater from the sink will run down into the dishwasher, as illustrated.

The drain hose is threaded onto a cone-shaped connecting pipe at the sink unit's water trap. The cone-shaped pipe must be cut to an internal diameter of at least 16 mm.

The drain hose may be lengthened by a maximum of 3 m. Any connections and connecting pipes must have an internal diameter of at least 16 mm.

No part of the drain hose may be more than 950 mm above the floor.

The hose must not be routed directly to the floor drain or similar. In such cases, the hose can act as a siphon and empty the dishwasher.

The hose must always discharge at least 350 mm above the floor.

Positioning the machine

A. Adjusting machines with 6 feet (freestanding dishwasher)

1. Adjust the height of the dishwasher with the four steel feet.
2. Lock the feet with the nuts.
NB! The dishwasher must not be allowed to lean more than 5 mm.

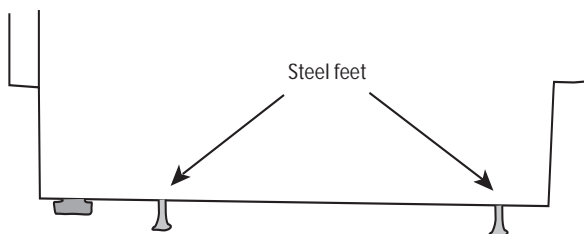

3. After the steel feet have been adjusted, screw down the two rubber feet tightly against the floor.
The rubber feet now work as anti-tilt protection.

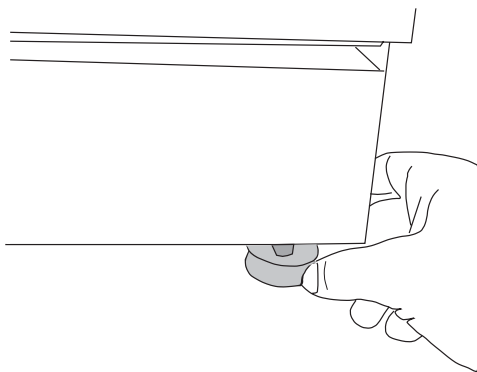

B. Adjusting machines with three or four feet

1. Start by measuring the height from the floor to the underside of the work top of your kitchen bench.
2. Install the sliding feet on the dishwasher.

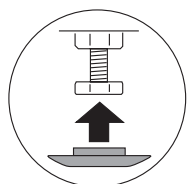

3. Measure the height from the floor to the top edge of the dishwasher.
4. Adjust all the feet by screwing them

- clockwise to raise or anti-clockwise to lower.
5. Check that the height of the machine corresponds to the height from the floor to the underside of the work surface.
Tighten the locking nuts (locking nut) on the rear feet.
6. Push the dishwasher into place.
7. Finely adjust the front feet (the machine may lean max. 5 mm) and tighten the locking nuts.

C. Adjusting dishwashers with adjustable foot

1. Start by measuring the height from the floor to the underside of the work surface.
2. Install the sliding feet on the dishwasher.

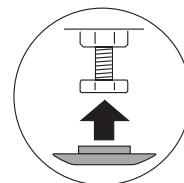

3. Measure the height from the floor to the top edge of the dishwasher.
4. Tilt the dishwasher forward a fraction and roughly adjust the rear foot by screwing the set screw at the front clockwise to raise or anti-clockwise to lower (illustrated below).
Use a broad screwdriver or a hexagonal head screwdriver.
5. Adjust the front feet by turning them clockwise to raise or anti-clockwise to lower.
6. Check that the height of the machine corresponds to the height from the floor to the underside of the work surface.
7. Push the dishwasher into place.
8. Finely adjust the feet (the machine may lean max. 5 mm) and tighten the locking nuts on the front feet.

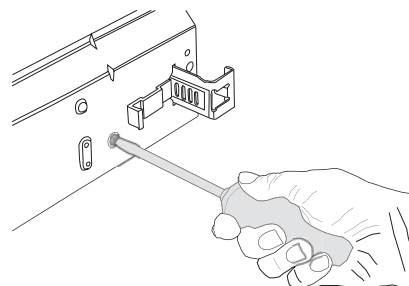

To prevent kinks, pull the drain hose and the connecting pipe.

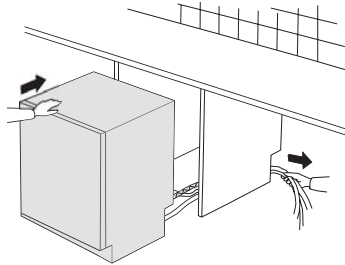

Installing the plinth (Only with kick-plate as accessory)

The dishwasher has two kick-plates (some models).

The taller one should be used if the machine is to be 850 - 870 mm high and the depth of the plinth can be varied between 45 - 105 mm. The lower one is to be used if the machine will be 820 - 845 mm with a plinth depth of between 50 - 105 mm. Attach the enclosed felt insulation to the kick-plate (some models).

Set the correct plinth depth as follows:

1. Bring the grey hooks towards each other and pull out the brackets as far as required. Press in the catches so that they lock the brackets in place.
2. Suspend the kick-plate from the brackets by pushing into the slots.

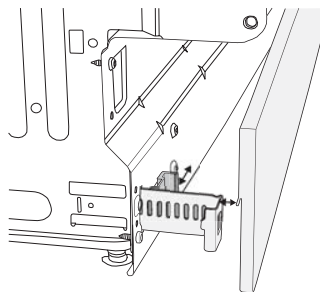

Screw the dishwasher into place

The enclosed plastic plugs are used for covering the screw holes if the dishwasher is to be screwed at the sides. After fixing check that the front feet are in contact with the floor.

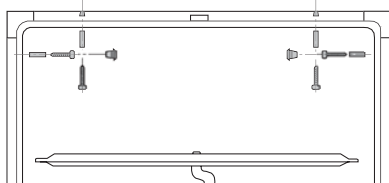

Fitting fixed kick-plate

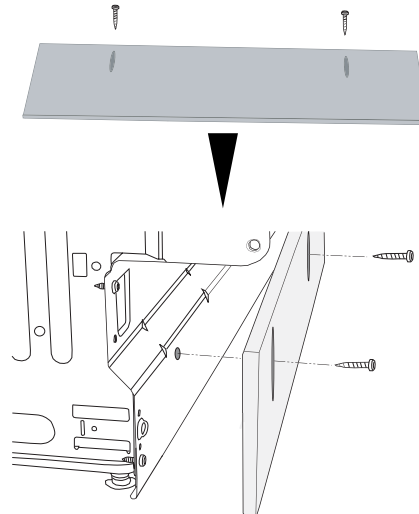

Fitting strip seal (on floor plinth covering plate)

Proceed as follows:

1. Remove the plastic plinth by gripping with both hands under the plastic plinth (A), and break outwards and upwards.

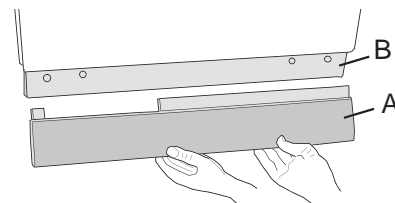

2. Undo the two screws on the covering plate (B).
3. Glue the accompanying rubber strip (C) to the underside of the covering plate (against the floor).
4. Screw the covering plate back into place. Adjust the covering plate so that the rubber strip is just in contact with the floor.

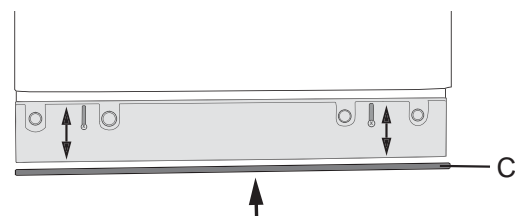

5. Replace the plastic plinth



Setting water hardness

If you have a dishwasher with a water softener, you may need to change the setting depending on the water's hardness level. Phone your local Water Board to check the water hardness in your area. The dishwasher is set for low water hardness on delivery.

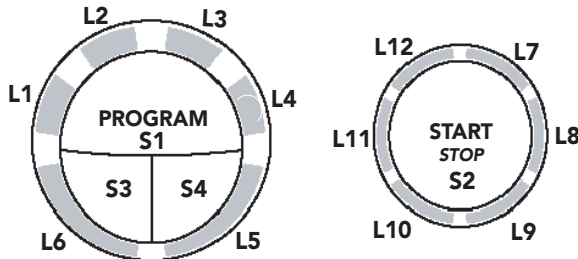

1. Switch off the dishwasher with the main switch.
2. Press the main switch while holding in the Start/Stop button.
3. Release both buttons and the L7 light will flash.
4. Select desired setting (see table below) by pressing repeatedly on the Program button.

| Setting | °dH | °fH |
|--------------------------------------|-----------|-----------|
| All extinguished | 0-5* | 0-9* |
| L1 lit | 6-8 | 9-14 |
| L1, L2 lit | 9-14 | 15-25 |
| L1, L2, L3 lit | 15-19 | 26-34 |
| L1, L2, L3, L4 lit | 20-29 | 35-52 |
| L1, L2, L3, L4, L5, L11 lit | 30-44 | 53-79 |
| L1, L2, L3, L4, L5, L6, L11, L12 lit | 45 and up | 80 and up |

5. Confirm your selection by pressing the Start/Stop button. You now automatically leave the settings menu and the selected setting remains until you want to change it.

Service & guarantee

Service

Before calling for service, check to see whether the faults are due to something that you can rectify yourself. See Trouble shooting pages **24-26**.

Guarantee

For guarantee details, see the guarantee card.

Search words

C

Child safety 5, 7
Crystal 5, 14

D

Dishes 5, 6, 11, 12, 14
Dishwasher detergent 6, 8, 10, 11, 13, 17, 20
Drainage 27, 28

E

Energy 13, 26
Environment 36

G

Guarantee 32

L

Lime 17

P

Plastics 5, 14
Programs 12, 15, 16

Q

Quick Guide 36

R

Rinse aid 5, 8, 10, 18, 19

S

Safety 5, 6, 28
Salt 5, 20, 21
SCS 15
Service 6, 22
Settings 21
Silver 11, 14

W

Washing programs 12, 17
Water hardness 5, 21, 31
Water softener 5, 8, 11, 20, 21, 26, 31
Winter storage 6

1. Loading the baskets

Remove large food particles and debris. There is **no** need to rinse thanks to the Super Cleaning System™.

2. Dispensing dishwasher detergent

The detergent compartment has a small compartment for pre-wash and one for main wash.





3. Ensure that the spray arms can rotate freely

4. Switch on the main switch

5. Close the door

6. Select program and press start

Mini Program Guide

| Program | | Tested program | | |
|-----------------------|---|---|---|---|
| Press |  |  |  |  |
| Program | Heavy wash | Normal wash | Quick wash | Rinse & Hold |
| Options |  | -- | -- | -- |
| How the machine works | | | | |
| Temperature Main wash | 70°C | 45°C | 30°C | -- |
| Final rinse | 70°C | 60°C | -- | -- |

Art. No.: 80 752 57. Rev. 02. We reserve the right to make changes. Disclaimer! Not all models contain all the features listed in this manual.

Printed on environmentally-friendly paper which meets the demands of Friends of the Earth and the Swedish Society for Nature Conservation.

