

How to use the washing machine

10504

Important:

**Read all instructions before using the appliance.
The machine must be installed by a qualified
electrician.**

**The machine must not be started until the transit
packing has been removed. (It prevents the tub from
shaking while the machine is being transported.)**

**WARNING – To reduce the risk of fire, electric shock, or
injury to persons, read the IMPORTANT SAFETY
INSTRUCTIONS before operating this appliance.**

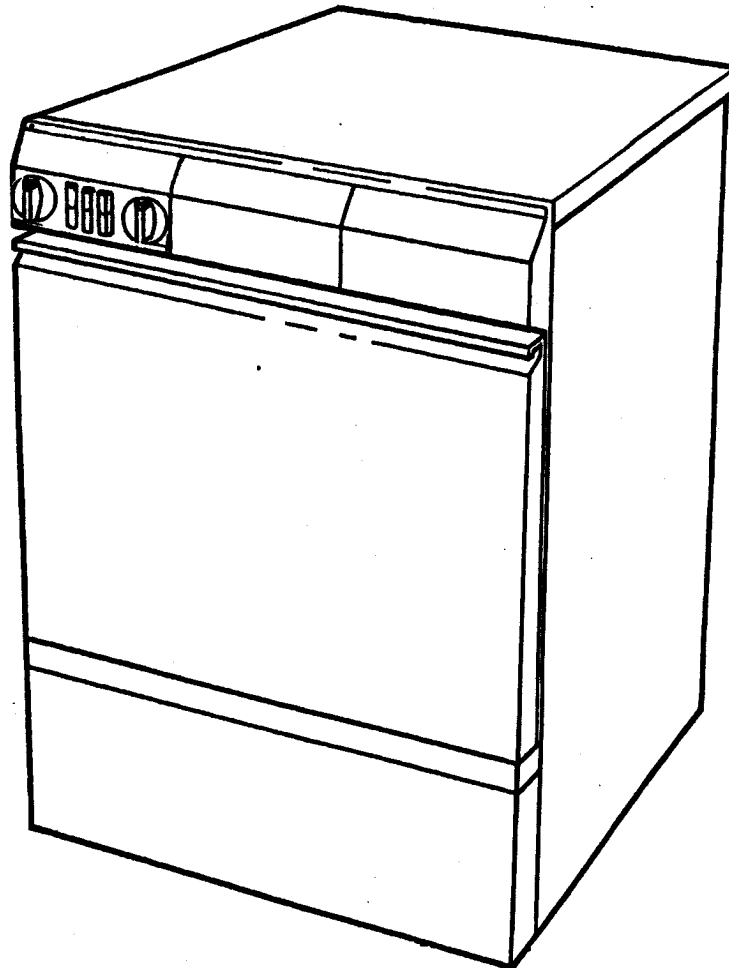

WARNING - Important!

Improper connection of the equipment grounding conductor can result in a risk of electric shock. Check with a qualified electrician or serviceman if you are in doubt as to whether the appliance is properly grounded.

This appliance must be grounded. The plug must be plugged into an appliance outlet that is properly installed and grounded in accordance with all local codes and ordinances.

Do not wash or dry articles that have been previously cleaned in, washed in, soaked in, or spotted with gasoline, dry-cleaning solvents, other flammable or explosive substances as they give off vapors that could ignite or explode.

How to use the machine

Follow the figures in the strip through this booklet for brief instructions on how to use the machine.

Full details and comments can be found below the strip and must be fully read before operating the washing machine.

Contents:

How to use the machine	2
Guide to parts	2
The control panel	3
Opening the door	3
Sorting the washing	4
Detergent	5
Which program should I use?	6
Program examples	6-7
Care of the machine	8
Safety	9
If the machine won't work	9
Technical details	10
Installation	10-11
<i>Removing the transport braces</i>	
<i>Adjusting the feet</i>	
<i>Building in the machine</i>	
<i>Electrical installation</i>	
<i>Water supply</i>	
<i>Draining connection</i>	
Problems and Solutions	12-14
Warranty	15
Instructions Summary	16
<i>How to use the machine</i>	
<i>Choosing the right program</i>	

Guide to parts

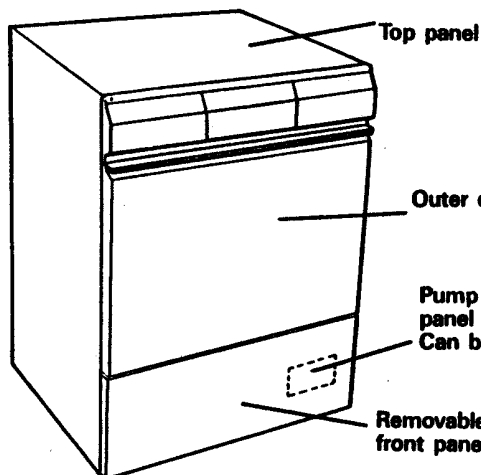

This indicator light shows when the machine is turned on

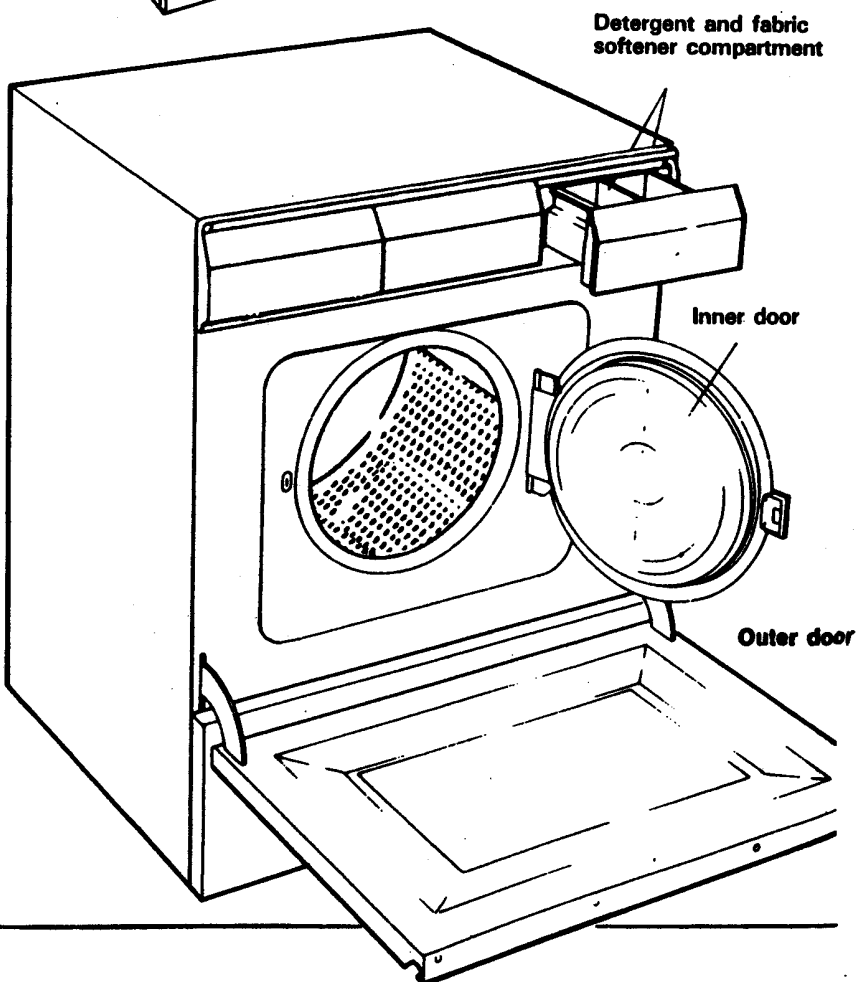

1. Press the main On/Off button.

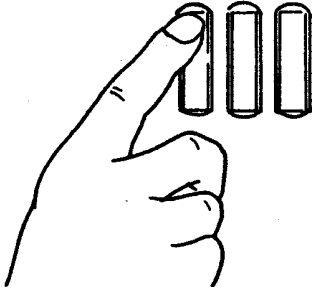

2. Open the door by pressing



If the door does not open, see below.

The control panel

Program control knob

The program control knob must be turned clockwise only.

Program options

Thermostat knob

Indicating lamp

Lights to show that the power is turned on.

Safety device

Ensures that a child cannot change the temperature setting. Press the button while turning the temperature knob to a higher temperature (clockwise). See also page 9.

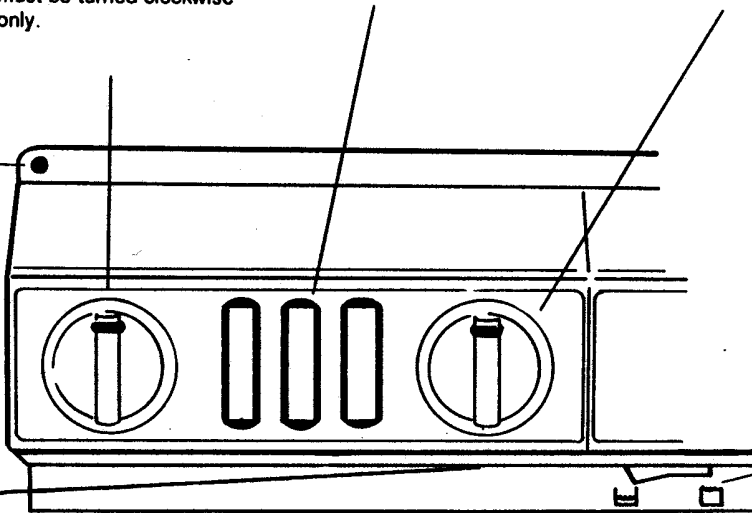

Rinse level

For a high rinse water level, press the right-hand end of the switch. Press the left-hand end to revert to the normal rinse water level.

Main On/Off switch

Must be pressed in when opening the door.

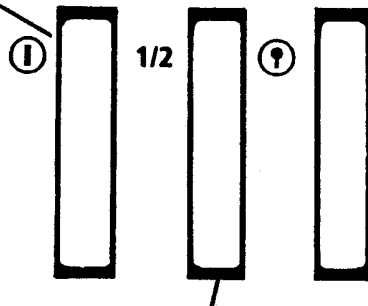

Door opening

The door can be opened only when the program control knob is at the end of a program, as shown by the red mark. If it has stopped anywhere else, turn it to position 9 to pump out the water. The door can be opened about two minutes after pumping out.

Half load button

Use this button for small loads. Pressing it omits two rinses and the intermediate spin in programs 1-3. One rinse is omitted in programs 5 and 6.

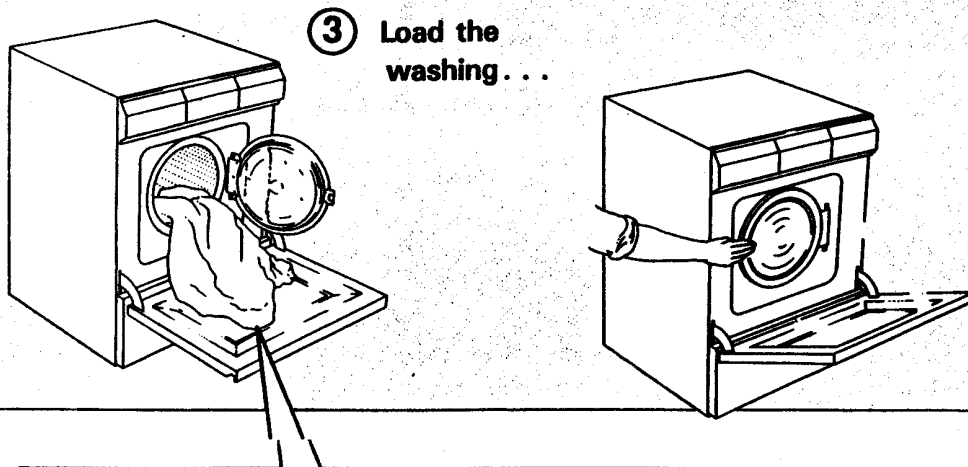

③ Load the washing . . .

. . . and press the inner door shut.
(It cannot be slammed shut.)

Close the outer cover.

Sort the washing

Sort clothes by color, fiber content, amount of soil, lint shedding properties (cotton, chenille, and terrycloth shed), lint attracting properties (permanent press, corduroy, velveteen, flannel and synthetics attract) and those requiring a delicate cycle. Most clothes and other washable items have **permanent care labels**. Read these labels carefully! Care label instructions and warnings should be followed for the best cleaning results.

Load the Washer Properly

The following chart shows how full to load the washer for the best results. The load size depends on what types of fabrics you are washing.

Permanent press items need room to move freely during washing for the most wrinkle-free results. Therefore, fill the machine only **half full** for permanent press loads. These items should only have a **brief spin** cycle after which they should be promptly removed from the washer for drying. Follow the guidelines on the Program Charts for "permanent press, synthetics".

Machine washable **wool** loads should only be one-third full for the cleanest results in this shortened cycle.

Recommended load sizes

Full Load	Half Load	Third Load
Cotton Linen	Permanent Press Synthetics Acrylics Special finish cottons	Wool (machine washable) Silk Acetates

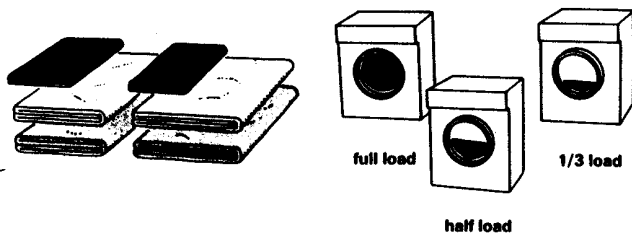

How much is in a full load?

If the drum is filled without packing it tightly, it will hold the equivalent of two sheets, pillow cases and mattress pad or thin blanket off of a queen size bed or two king size sheets, two pillow cases and two to four bath towels.

Water level in the washer

There is no need to set a load size or water level because the Asko Automatic Level Control System automatically selects the correct amount of water for each load.

Preparing clothes for washing

- Turn delicate items, sweaters and t-shirts inside out to prevent pilling and to protect the prints.
- Empty pockets and turn them inside out.
- Remove any sharp ornaments, pins or buckles to prevent snags.
- Close zippers and hooks to prevent snagging.
- Tie sashes and strings to prevent tangling.
- Mend any small rips or tears to prevent them from getting bigger.



New colored items

Read labels carefully! If a label says "Wash Separately", the item will lose color (excess dye) for the first few washings. To minimize the possibility of this color transferring to white or lighter colored items, wash new colored garments with items of similar color or alone before wearing. Bright reds and oranges on cottons are the dyes most likely to transfer colors to the wash load. Fluorescent colors should always be washed separately.

Prewash or not?

When washing items that are only slightly soiled, the prewash cycle can be omitted. Starting the machine at the main wash stage will save about 25 minutes.

4. Pour detergent (and fabric softener, if used) into the appropriate sections of the detergent compartment.

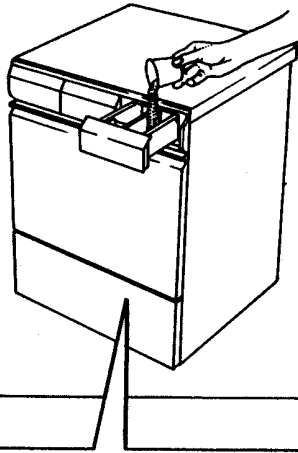

Detergents-What kind-How much?

Use only low sudsing laundry detergents!

Detergents are available in low, normal and full sudsing formulas. A detergent's ability to clean is **not** related to the amount of suds it produces. Excess suds in a front loading washer actually interfere with cleaning action because they cushion the tumbling of clothes. High sudsing detergents are also more difficult to completely rinse out.

Use 1/4 to 1/2 of the recommended U.S. detergents

Because of the Asko washer's low water consumption and the fact that all the wash water and detergent are completely circulated repeatedly through the laundry, ensuring that all the detergent is fully utilized, detergent usage is cut by 50% to 75%. Different brands of detergents recommend using different amounts. Read all package labels carefully. The first time you use any detergent, **start with 1/4 of the recommended amount.** (For example: if the label says use 1 cup, use 1/4 cup.)

If the detergent produces a good, low level of suds, you may add slightly more detergent if you have **very hard water** or if your clothes are not getting perfectly clean. It is advisable to check your water hardness with the local water department.

Recommended detergents

Avoid normal and full sudsing detergents. The chart below lists several low sudsing detergents that have been successfully tested in the Asko washer, along with the recommended amounts.

Recommended Detergents	Main Wash Detergent Amount*
Fab (powder)	1/4 cup to 1/2 cup
Amway SA8 (powder)	1-2 tablespoons (1/8 cup)
Fresh Start (powder)	2 tablespoons (1/8 cup) to 1/4 cup
All (powder)	1/4 cup to 1/2 cup

* Add slightly less additional detergent for prewash (program 1 only).

In general, liquid detergents tend to be higher sudsing than powders. Do not use powder detergents that do not wash completely out of the detergent cup as the machine fills with water.

Liquid detergents

Liquid detergents tend to produce more suds than powder detergents. When trying a liquid detergent for the first time, start out with a very small amount, such as 1 to 2 tablespoons.

Liquid detergent can be used for all programs without pre-wash. Add it into the main wash compartment.

Bleach

The use of bleaches is **not necessary** with these machines, nor is it recommended.

Note: Detergents: Using more detergent does not improve the washing performance, but merely imposes an extra load on the environment. Try reducing the amount of detergent you use, and increase it only if the results are unsatisfactory.

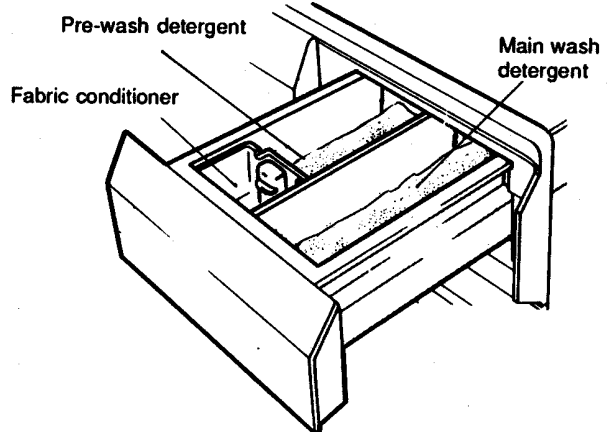

Fabric softeners

Use 1/3 to 1/2 of the recommended amount of fabric softener, because of the low water usage of the Asko washer. Fabric softeners are available in several concentrations. Read the labels carefully and use only 1/3 to 1/2 of the recommended amount. (For example: if the label says to use 1 capful, use 1/4 capful.) If more softening is desired, try adding slightly more the next time.

Oversudsing

The use of anything other than a low sudsing detergent can cause severe oversudsing. If this happens, run the wash through one or more rinse programs (starting on 5) until items are thoroughly rinsed. Then, run the empty washer through an entire wash program (starting on 1) to clear the machine of any remaining high sudsing detergent.

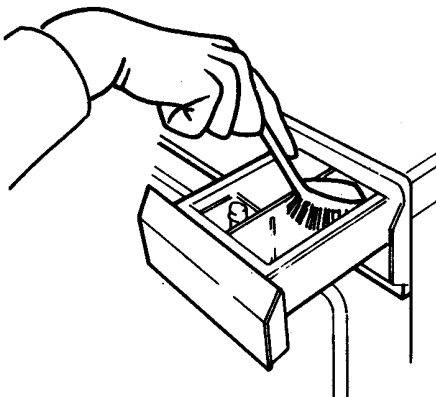

Clean the detergent compartment regularly

1. Pull out the compartment and remove the fabric conditioner insert.
2. Select any program.
3. Clean the compartment with a brush while water flows through it.
4. When finished, select program 8 to pump the water out of the machine.

5. Set the required temperature on the thermostat . . .

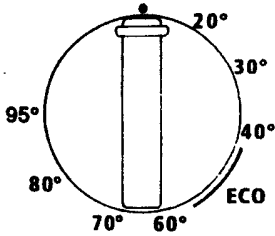

6. Press any required program option buttons

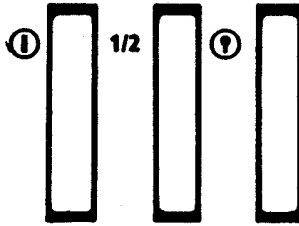

7. . . . and start the program with the program knob.

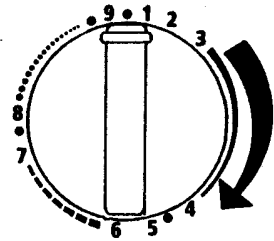

Remember – turn the program knob clockwise only.

What the figures on the program knob mean

8 Wool program

8. Start wool

9 Pumping out

1–4 Whites/Colors

1. Start Whites/Colors with prewash

2. Start Whites/Colors, main wash

3. Start Quick wash program

4. Long spin

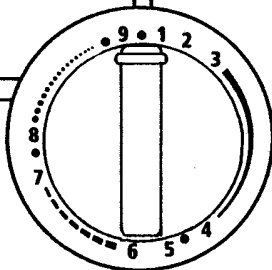

5–7 Synthetics

5. Start long Synthetics wash

6. Start short Synthetics wash

7. Short spin

The red marks

indicate program finishing points. The door can be opened only when the pointer is against a red mark. For safety reasons, there is a delay of about two minutes after the end of a program before the door can be opened.

Quick Wash program

The machine has a special Quick Wash program, which saves both time and energy.

The program can be used at any temperature. If the load is small, you can also press the half-load button and speed the program up even more.

Which program should I choose?

You can naturally select a standard program or, by combining your preferred temperature setting, program and option selection, produce a program to suit your requirements.

The programs below are suggestions, with the shaded programs being the standard programs.

Fabric care label	Type of Fabric	Fill	Program	Option button	Temperature
	White cottons with pre-wash	●	1		95°
	White cottons without pre-wash	●	2		95°
	Fast colors	●	2		60°
	Non-colorfast cottons	◐	2	1/2	40°
	Quick wash	◐	3	1/2	40°
	Acrylics, white	◐	5		60°
	Acrylics, colors	◐	5		40°
	Quick synthetics wash*	◐	6		40°
	Delicates/Wool	○	8		40°

8. The machine starts and works through the stages shown below.

If you change your mind . . .

. . . and want a different program:

Turn the program knob and thermostat knob to the required positions, and press any option switches that you want.

. . . or want to interrupt the program

Turn the program knob to 9 to make the machine pump out. After about two minutes, you can open the door. If you add more washing and restart the machine, check that there is detergent left in the detergent compartment.

- Points to note:**
- The Wool program cannot be modified by the option buttons.
 - The main wash in programs 2 and 5 starts with a cold soak in order to remove stains such as blood.
 - The main wash water is always cooled by the admission of cold water before pumping out in order to prevent risk of scalding.
 - Before starting to spin, the machine checks that the load is evenly distributed in the drum. If not, it redistributes the load by turning at normal drum speed and then makes another attempt to start spinning.

Water-consumption, gallons	Automatic operations:					
	Pre-wash	Main wash	3 rinses	Spin, 3.5 min	2 rinses	Spin, 9 min
17	■	■	■ ■ ■	⊙	■ ■	⊙
16		■	■ ■ ■	⊙	■ ■	⊙
16		■	■ ■ ■	⊙	■ ■	⊙
10		■	■ ■ ■			⊙
10		■	■ ■ ■			⊙
10		■	■ ■ ■	⊙		
10		■	■ ■ ■	⊙		
9		■	■ ■ ■	⊙		
17		■	■ ■ ■	⊙		

* This program is ideal for small, slightly soiled loads, which only need freshening. For best results, use only 1/3 of the normal recommended dosage of detergent.

The machine finished these programs with a short spin.

The machine stops with the final rinse water still in it.

Turn the program knob to 9 to pump out the machine. Or you can turn it to 7 for pumping out followed by a short spin. Most garments can withstand a short, careful spin.

9. When the machine has stopped:

Open the door
by pressing



- After a program that has finished by pumping out the water, you can open the door after about two minutes.
- After a program that has finished with water left in the machine, turn the program knob to 7 or 9 to pump out the water (7 will give a short spin). You can then open the door after a further two minutes.

Care of the machine

Check the needle trap and outlet pump

The machine has a needle trap which will trap needles, hairpins, coins and similar items. Clean it at intervals as follows:

1. Open the flap in front of the pump, and place a bowl on the floor in front of it (1).
2. Turn the pump cover counter clockwise to the position shown in (2). This uncovers the drain holes and water will run out into the bowl.
3. When the water has finished draining out, turn the pump cover further and pull it off. Clean out the needle trap, and clean the pump rotor at the back of the pump housing (3).
4. Check that there is no grit or small objects in the pump, and replace the pump cover. Turn it clockwise in two stages: when you hear a click, turn it a little more to its end stop, as shown in (4).

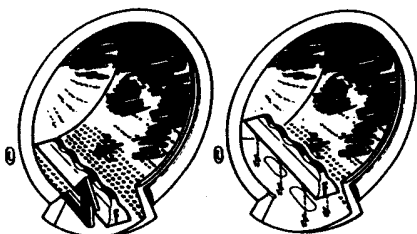
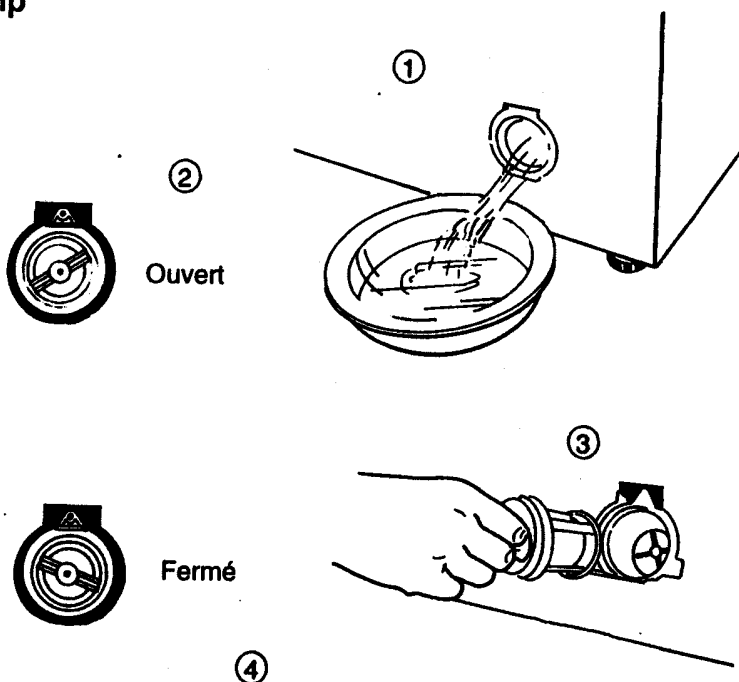

Access openings under the drum paddles

If an object has fallen between the drum and the outer container, you can get it out as follows:

1. Undo the screw on top of the paddle with a screwdriver (three turns).
2. Pull the paddle towards you and lift it upwards.
3. Remove the object. Be careful not to bend the immersion heater elements.
4. Locate the paddle in its fixing hole, with the F-mark to the front (i.e. facing you). Slide the paddle backwards as far as it will go. Check that its clips are properly located in the slots in the drum, and retighten the screw.

10. After use:

Turn off the machine at the On/Off button.

Note: Don't close the door after using the machine: leave it ajar.

Safety

The machine cannot be started if the inner door is open. The inner door cannot be opened while the machine is running or if it has stopped with water in.

Safety catch

The machine has a safety catch which prevents children from turning the thermostat/main switch away from the 0 position or increasing the temperature. As supplied, the safety catch on the machine is disengaged.

To engage it:

- Press the button beneath the thermostat knob and then release it.

To disengage the safety catch:

- Press the slot in the end of the button with a coin.
- Push and turn the button slightly in the same direction as if screwing in a screw (clockwise).

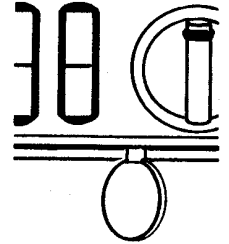

If the machine won't work

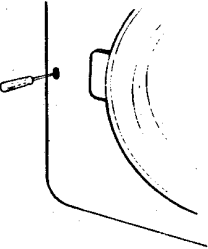
Problem	Response
<p>The door will not open.</p> 	<ol style="list-style-type: none">1. Check that the main On/Off switch is turned on.2. If the indicator lamp is not lit, there is no power supply. Check the plug and fuses. The door cannot be opened normally if there is no power supply.3. If the door cannot be opened in the normal manner, it can be opened as follows. Insert a small screwdriver in the hole to the left of the door and press the door catch upwards to release the door. <p>If the door still cannot be opened in the normal way afterwards, call a service technician.</p>
<p>The machine does not fill with water when started.</p>	<ol style="list-style-type: none">1. Is the tap in the supply line open?2. Is the strainer in the inlet connection blocked? Unscrew the hose and check. Remember to turn off the water supply first.
<p>The machine does not start when the program knob is turned to the starting position.</p>	<ol style="list-style-type: none">1. Is the door properly closed? Press it shut firmly – don't slam it.2. Is the main On/Off switch turned on?3. Has the power supply failed? Check the plug and fuses.
<p>The machine will not spin.</p>	<ol style="list-style-type: none">1. Is the pump or outlet hose blocked? Clean if necessary, as described on page 8.2. Has the power supply failed? Check the plug and fuses.3. The machine will make up to 30 attempts to start, redistributing the washing if the drum is out of balance. After that, it passes on to the next stage of the program.
<p>A lot of foam in the final rinse water, or water left in the machine after spinning and pumping out.</p>	<ol style="list-style-type: none">1. Is anything blocking the outlet hose? A button or a coin can do so. Make sure that no part of the hose (including any joints) is less than 5/8" mm in diameter.2. Is the pump blocked? Clean it as described on page 8.3. Is the outlet hose kinked?

Specifications

Dimensions	32 1/4" x 23 1/2" x 23 1/2"
Weight	137 lbs.
Drum volume	43 liters
Spin speed	1000 rpm
Rated load	2100 W
Supply voltage	208–240 V, single-phase
Heater rating	1800 W
Material of drum and barrel	Stainless steel
Material of outer casing	Stove-enamelled hot-dip-galvanized steel sheet
Mounting	Stationary: four adjustable rubber covered feet
Water supply hose	63" pex hose
Supply pressure	0.1–1 MPa (10–100 N/cm ² , 1–10 kp/cm ² , 15–142 PSI)
Outlet	65" of poly- propene hose, 3/4" internal diameter

Accessories

The machine is supplied with:

- Operating instructions and installation instructions.
- Type-approved inlet hose for connection to water supply.

Installation

Removing the shipping brace

The shipping brace consists of two tubes which prevent the barrel from moving around inside the machine during transport. The tubes are secured to a cross beam at the back of the machine.

Remove the shipping brace as follows:

1. Remove the bolts and special washers which retain the beam, and remove the beam.
2. Replace the washers on the flattened part of the tubes. Use them as tools to turn the tubes through about 45°, as shown in the drawing, and pull out the tubes.
3. Turn the washers so that they cover the holes where the tubes were fitted and replace the bolts.
4. Remove the wooden blocks from inside the front casing of the machine.

Save the tubes and cross beam, which will be needed if the machine has to be transported elsewhere. Fit them in the reverse order to that described above.

Adjusting the feet

It is important that the machine does not move around when it is spinning. This means that it must be standing firmly and level on the floor. The four feet are individually adjustable. Set them carefully so that the machine is standing level, and tighten the locknuts securely.

Positioning the machine

The machine can be installed beneath a worktop with a height of 33 1/2"–35 1/2". There must be a gap of about 1/4" all round the machine, including between the rear edge of the machine top panel and the wall behind. This is important: if no space is left, the machine may hit the wall when it starts to spin.

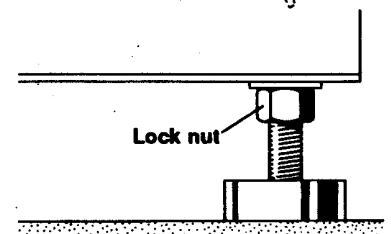
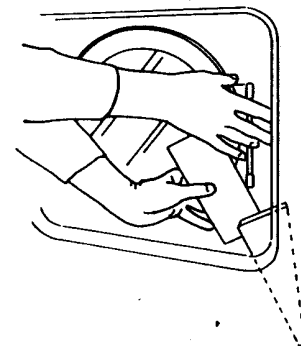
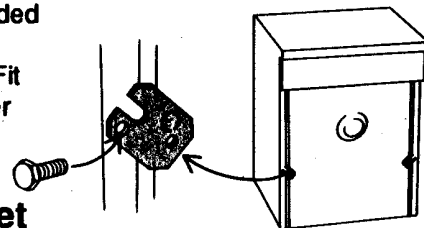
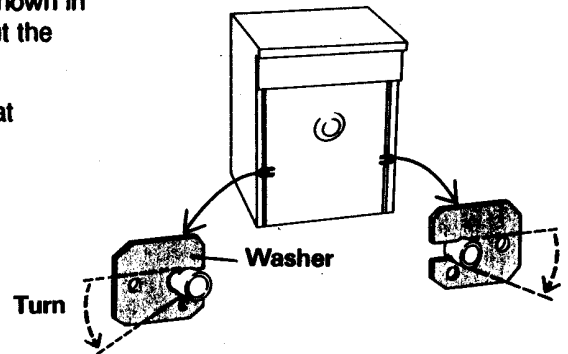
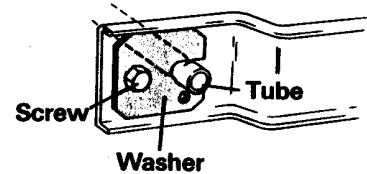
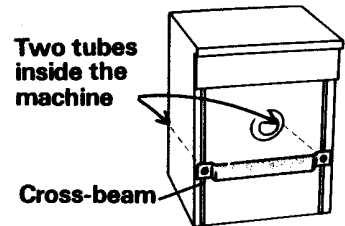

NOTE
Height Adjustment: 32 1/4"–33 1/2"
Do not Raise Higher than 33 1/2"

Electrical connection

Electrical specifications

Single phase, 208/240 Volt, minimum 15 A requirement.

ASKO washers and dryers are provided with a power supply cord and are internally protected with two 15 A fuses.

Single unit installation

Units are supplied with a power cord for the electrical supply. Be certain this supply cord is connected to the BLACK terminal block located on the upper back panel inside the unit. Since the units are internally protected, this cord can be connected to a 208/240 V supply with a minimum of 15 A. The plug for connection is not supplied with the unit. It may be direct wired to the electrical supply or a plug obtained locally.

Pair Installation

You will need to provide a 30 A, 250 V, AWG 10/3 standard U.S. dryer cord available at most home improvement or electrical supply stores. An ASKO washer and dryer can be installed together using the standard U.S. 250 V, 30 A dryer supply provided in most homes. Follow these steps for proper installation.

1. Remove the top of the washer by removing the three 25 Torx screws, located on the upper back of the unit. Lift the top rear and slide it back, then lift off.

2. Disconnect the electrical cord supplied with the washer from the terminal block and discard it.

3. Connect the electrical cord from the dryer to the washer by threading it through the power cord restraint on the washer which held the washer cord and connecting the wires to the TOP of the BLACK terminal block located on the upper back panel inside the unit. Tighten power cord restraint.

Water supply connection

The water supply connections must be made by a person having the necessary competence. Connect the machine to the supply using the hoses supplied with the machine. Water pressure must be in the range 15–146 PSI.

A tap must be fitted in the supply pipe for the hose. If a new supply pipe has been installed for the machine, it should be flushed through thoroughly in order to remove any particles of dirt which might otherwise block the strainer in the water inlet of the machine.

Drain outlet connection

The machine is supplied with the outlet hose ready fitted. The hose should be hung at a height of 15 3/4" - 35 1/2" above the floor: the lower height is preferable.

Make sure that the hose is not kinked.

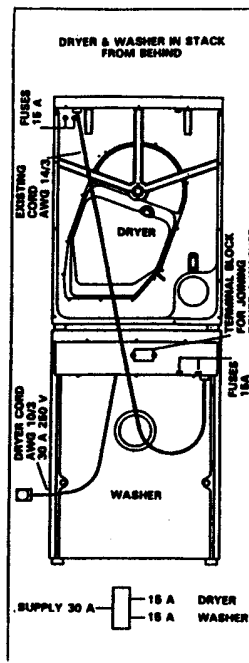

4. Remove the large knock-out directly below the BLACK terminal block.

5. Install the power cord restraint provided with the 30 A U.S. dryer cord.

6. Thread 30 A dryer cord through the cord restraint and connect the wires to the bottom of the BLACK terminal block. (If there are connectors on the ends of the wires, they must be removed.)

NOTE: The two outside connections are "HOT". The middle connection is neutral. This is also true for the 30 A dryer cord. Tighten the power cord restraint to hold 30 A U.S. dryer cord securely.

7. Replace top of washer and test units.

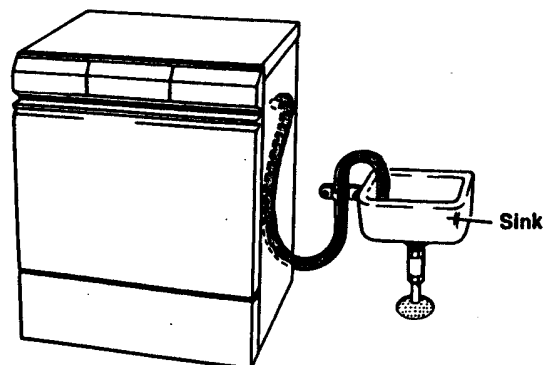
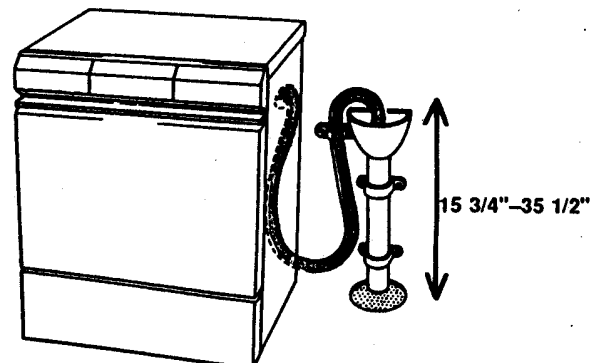
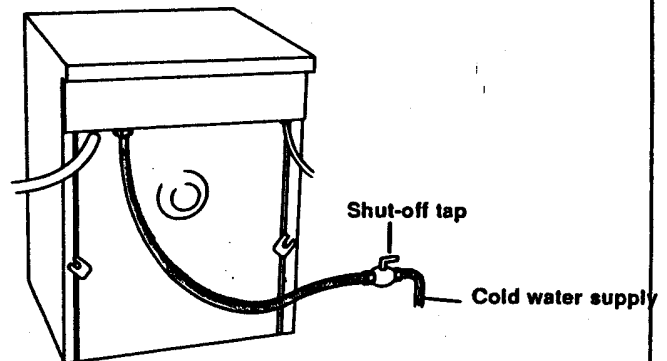

Problems?

Try the following remedies. Poor results may not always be caused by the machine. Read through the chart below before contacting your servicer.

Problem	Possible Cause	Suggested Remedy
Door will not open	—	See "If the machine doesn't work", page 9.
Machine will not start	—	
Machine will not fill with water	—	
Foam in final rinse, water left in machine	—	
Water leaks	Hoses	All hoses, especially the inlet hose should be inspected at least once a year. Replace if they show signs of cracking. Check to see if hose connections at faucets are tight. Properly insert and secure end of drain to drain facility.
Extreme vibration during spin cycle	Transit packing not removed	Remove transit packing. See page 10.
	Machine not level	Adjust machine feet and tighten locknuts.
Oversudsing	Wrong detergent	Use only low sudsing detergents. See page 5. Run clothes through extra rinse cycles. Run empty machine through complete cycle starting on "4".
	Too much detergent	Use recommended amounts. See page 5.
Washer stops during cycle	Normal pauses	It is normal for the machine to pause occasionally during operation, especially between cycles and during the delicate wash program.
Greying clothes	Not enough detergent	You may need to add slightly more detergent if clothes are heavily soiled, have oily stains, or if your water is very hard.
	Water not hot enough	Select hot enough temperature setting for each type of load. See charts page 6 and 16.
	Improperly prewashed or presoaked	Be sure to add a prewash and/or presoak for heavily soiled or oily items.
	Washer overloaded	Once wet, the clothes must have room to tumble freely, especially synthetics and permanent press.
	Soap used in hard water areas.	Be sure you use a laundry "detergent" and not a "soap". Soaps react with the minerals in hard water to form a soap curd, which can be deposited on clothes.

Problems? (Continued)

Try the following remedies. Poor results may not always be caused by the machine. Read through the chart below before contacting your servicer.

Problem	Possible Cause	Suggested Remedy
Lint, residue left on clothes	Improper sorting of clothes	Separate clothes that shed lint (chenile and terrycloth) from clothes that attract lint (synthetics, corduroy, velveteen).
	Nonphosphate detergent	Non-phosphate detergents can combine with minerals in hard water and form a precipitate which can appear to be lint. Use a low phosphate detergent, if possible. Install a water softener.
	Fabric softener used improperly	Read labels. Most softeners should only be used in the final rinse. Add softener to the softener compartment. If added to the wash cycle, softeners can have a reaction with detergents producing a white residue.
	Pilling	Pilling, which can look like lint, is produced by normal wear on cotton/polyester blend fabrics. To reduce, wash synthetics and cotton/polyester blends inside out. For the best results, wash cotton/polyester knits using the delicate cycle.
Yellowing of clothes	Not enough detergent, water not hot enough	Caused by body oils not completely removed. Use hottest recommended temperature for each type of load and add slightly more detergent.
	Iron or manganese in water	Install a filter to remove iron or manganese from water. A small amount of Calgon or other non-precipitating water conditioner added once a week is advisable in hard water areas.
Shrinkage	Improper washing or drying	Follow garment care label instructions carefully. Some fabrics will shrink no matter how they are washed. Some may be machine washed but not machine dried.
Knit shrinkage	Overheating	Knits tend to shrink more than woven fabrics. If a knit has been heat shaped, wash in cool or warm water. Dry with the low setting.
	Delayed or gradual shrinkage	Can occur when special stabilizing finishes are reduced from wear or repeated washings. Garment may sometimes be reshaped by pressing after washing and drying.
	Poor construction	Shrinkage can occur if the knit fabric was not stretched properly by the manufacturer. Press back into shape each time garment is washed and dried.
Rips, snags, excess wear	Sharp objects in pockets	Empty all pockets and turn inside out before laundering.
	Hooks, snaps, zippers, buckles	Fasten all hooks, snaps and zippers before laundering to avoid snags. Remove sharp buckles. Turn knits inside out.

Problems? (Continued)

Try the following remedies. Poor results may not always be caused by the machine. Read through the chart below before contacting your servicer.

Problem	Possible Cause	Suggested Remedy
Rips, snags, excess wear (continued)	Harsh chemicals	Before washing, rinse harsh chemicals, such as battery acid, permanent wave solution, hair bleach, dyes and toilet bowl cleaners, from towels and other articles to avoid holes in fabrics. Do not allow these unrinsed items to contact other fabrics.
	Existing rips and tears	Mend all garments before laundering to prevent enlarging of rips.
	Permanent press items	These items fray at edges from the permanent press process and from normal wear, not from the washer. Only wash in half loads. Do not wash in the same load with very heavy items, such as towels or jeans.
Fading and discoloring	Improper sorting	Dark clothes, especially cottons, can bleed excess dyes into wash water. White or light colored clothes can absorb the dye and discolor. Separate light from dark items.
	Crayons or pens in pockets.	Empty all pockets before washing.
	Water too hot	Cool or cold water is best for retaining dark or bright colors.
Stains not removed	Incorrect water temperature	Protein stains, such as milk, egg, blood and soy formula should be removed in cold water. Oily stains should be washed in the hottest water recommended for each fabric type.
	Old stains	The longer a stain remains on a fabric, the harder it is to remove. Treat stains promptly. Do not set stains by machine drying or ironing fabrics until stains are completely removed.



ASKO Product Warranty

Home Clothes Washers and Dryers

For Residential Installations

Length of warranty	ASKO will pay for:
ONE YEAR FULL WARRANTY From date of purchase	ASKO replacement parts and/or repair labor to correct defect in materials or workmanship. Service must be provided by an authorized ASKO service outlet.
FIVE YEAR LIMITED WARRANTY One year full plus second through fifth year limited from date of purchase.	ASKO replacement parts (repair labor costs not included) for any defective solid state controls, timers, motors, pumps.
TWENTY-FIVE YEAR LIMITED WARRANTY One year full plus second through twenty-five year limited from date of purchase.	ASKO replacement parts (repair labor costs not included) for the stainless steel inner and outer drum/tub if it fails to hold water due to a manufacturing defect such as cracking or rusting.

For Non-Residential Installations

SIX MONTHS FULL WARRANTY FROM DATE OF PURCHASE	ASKO replacement parts and/or labor to correct defect in materials or workmanship. Service to be provided by an authorized ASKO service outlet.
---	---

<p>ASKO will not pay for:</p> <p>A. Service calls to:</p> <ol style="list-style-type: none"> 1. Correct the installation of the washer or dryer 2. Instruct how to use the washer or dryer 3. Replace house fuses or correct housing wiring 4. Correct house plumbing 5. Cleaning or servicing of the button trap, outlet pump of the washer 6. Cleaning or servicing of the lint filter or condensing unit of the dryer <p>B. Repair and/or parts for failure of product if washer or dryer is used in other than normal use.</p> <p>C. Damage resulting from accident, fire, floods, acts of God, alteration, misuse abuse, improper installation or installation not in accordance with local electrical or plumbing codes.</p> <p>D. Any labor or shipping costs for parts during the limited warranty.</p> <p>E. Replacement parts or repair labor costs for units operated outside the Continental United States.</p> <p>F. Pick-up and delivery. ASKO products are designed to be repaired in the home.</p>



IN NO EVENT SHALL ASKO INC. BE RESPONSIBLE FOR ANY INCIDENTAL OR CONSEQUENTIAL DAMAGES.

Some states will not allow the exclusion or limitation of incidental or consequential damages, so this exclusion or limitation may not apply to you. This warranty gives you specific legal rights and you may also have other rights which vary from state to state.





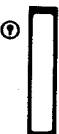
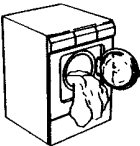
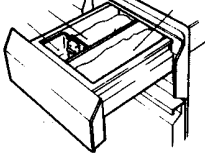
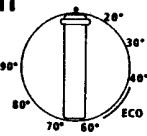
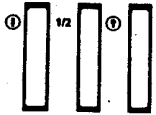
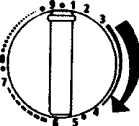

For warranty service, contact the dealer from whom you purchased the unit or an authorized ASKO service outlet. Service will be provided during normal business hours. Should you have a service problem that is not resolved locally write:

ASKO USA INC.
P.O. Box 851805
Richardson, TX 75085-1805

Summary of washing instructions

- 1 Press the main On/Off switch. 
- 2 Open the door by pushing 
- 3 Load the washing and close the door firmly. 
- 4 Pour detergent and fabric conditioner into the detergent compartment. 
- 5 Set the temperature with the thermostat knob. 
- 6 Select any program options. 
- 7 Turn the program knob to the required program, and the machine will start. 
- 8 **When the machine stops:**
 - * Open the door by pressing 
 - * After a program that has finished by pumping out the water, you can open the door after about two minutes.
 - * After a program that has finished with water left in the machine, turn the program knob to 9 to pump out the water. You can then open the door after a further two minutes.
- 9 **After using the machine:** Turn off the main switch. Leave the door ajar. 

Choosing the right program

Fabric care label	Type of Fabric	Fill	Program	Option button	Temperature
	White cottons with pre-wash	●	1		95°
	White cottons without pre-wash	●	2		95°
	Fast colors	●	2		60°
	Non-colorfast cottons	◐	2	1/2	40°
	Quick wash	◐	3	1/2	40°
	Acrylics, white	◐	5		60°
	Acrylics, colors	◐	5		40°
	Quick synthetics wash	◐	6	1/2	40°
	Delicates/Wool	○	8		40°

It is not permitted to make any changes to the specifications of the machine without the written permission of the manufacturer.