

This Owner's Manual is provided and hosted by [Appliance Factory Parts](#).

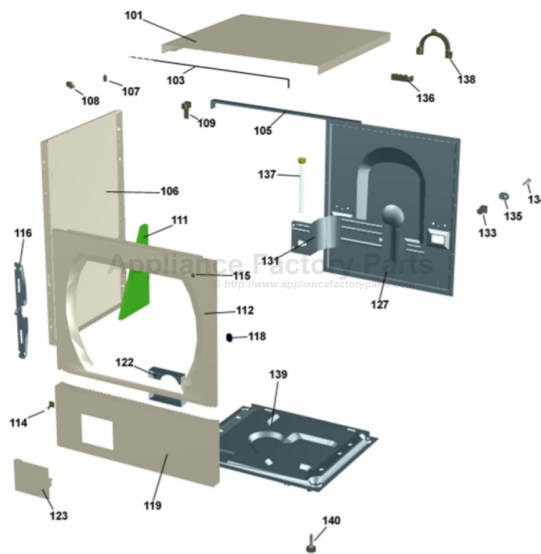

ASKO W620 Owner's Manual

[Shop genuine replacement parts for ASKO W620](#)



[Find Your ASKO Washer Parts - Select From 53 Models](#)

----- Manual continues below -----

Washing Machine ASKO W620

DEAR ASKO CUSTOMER!

Welcome to the family of ASKO customers. We trust that you will have many useful years with your new washing machine. This washing machine incorporates many features, and to get the best benefit from all the different functions we recommend that you study the Use and Care Guide before attempting to use the machine.

CONTENTS

READ FIRST

- 1 Before washing the first time** 3
- 2 Safety instructions** 4
 - General. Installation. Washer door. Interrupting a program. Overfill protection. Packing material. Transport/Winter storage. Disposal.
- 3 Children's safety** 5
 - Child-safe washing. Protect children. Child safety catch on detergent compartment. Child safety catch on temperature knob
- 4 Parts of the washer** 6
- 5 Detergent compartment** 6
- 6 Panel** 7

INSTALLATION

See instructions for installation.

WASHING

- 7 Before washing** 8-10
 - Sorting the washing. Garments. Recommended washing marking. Coloured cotton. Delicate washing. Minimizing allergy hazards. Economy and efficiency. Detergents. Textile dyeing.
- 8 Washing** 11-14
 - Main power switch. Filling detergent. Selecting settings and options. Selecting program. Starting the washing program. Washing program completed. When washing is finished.
- 9 Consumption values** 15

CARE

- 10 Care and Cleaning** 16-17
 - Cleaning the needle trap and drain pump.
 - Cleaning the detergent compartment. Cleaning the outside of the machine. Clean-out recess under the ridges. If you have hard water.

PROBLEMS?

- 11 Trouble shooting** 18-19
 - Machine will not start. Door will not close. Door will not open. Fault indications.

MISCELLANEOUS

- 12 Technical information** 20
 - Technical data. Standard tests.
- 13 Service and guarantee** 21
- 14 Quick guide** 22
- 15 Index** 23

1 BEFORE WASHING THE FIRST TIME

CAUTION WITH CERTAIN MATERIALS

Always check and adhere to recommended washing marking on the items concerned. If no recommendations are given, refer to those in Chapter 7, Before washing.

TRANSPORT SUPPORTS

Are the transport supports (three screws at the back of the machine) removed? If not, see the Installation instructions.

WASHER DOOR

The door of the washer opens electrically. Consequently, the door cannot be opened normally until the machine is connected to an electric power supply. However, emergency opening is available, see Chapter 11, Trouble shooting.

CHECK HARDNESS OF THE WATER

Call your local water company to find out what degree of water hardness applies. This has significance in relation to the amount of detergent that should be dispensed.

2 SAFETY INSTRUCTIONS



GENERAL

- Study and save this Use and Care Guide for future reference.
- Electrical and water installation, if required, must be carried out by authorized persons.
- The machine may only be used for washing in accordance with this Use and Care Guide - not for dry cleaning.
- Use only detergents intended for machine washing.
- Remove the transport supports before using the machine, see installation instructions.

INSTALLATION

See the accompanying installation instructions.

WASHER DOOR

The door of the washer opens electrically. Consequently, the door cannot be opened normally until the machine is connected to an electric power supply.

To open the door manually, see the heading, Door will not open, in Chapter 11, Trouble shooting.

The machine cannot be started with the door open.

To open the door during an ongoing program, see below, Interrupting a program.

INTERRUPTING A PROGRAM

To interrupt a washing program, turn the program knob forward to position 10, Drain. Any water in the machine will be pumped out. Press the  button to open the door. To restart:

Fill with additional detergent if required, set a new program and close the door and the machine will start.

OVERFILL PROTECTION

If the level of water in the machine rises above normal, the overfill protection will start to pump out water and shut off the water supply. The program will be interrupted if the level does not fall within 60 seconds.

PACKING MATERIAL

Sort the packing material for recycling according to recommendations by the local authorities.

TRANSPORT/WINTER STORAGE

If the machine is to be transported or stored during the winter, on unheated premises, empty the needle trap and the drain pump, see Chapter 10, Care and cleaning.

If you have any questions, please phone your retailer.

DISPOSAL

When the machine is no longer useful and is to be scrapped it should immediately be made unusable.

Get in touch with the refuse collection service or your local authorities for advice on how to scrap the machine in a proper manner for recycling.

The machine is made and marked to facilitate recycling.

3 CHILDREN'S SAFETY



CHILD-SAFE WASHING

Always close the washer door and start the program immediately after filling the detergent.

Do not allow children to play with the washing machine.

PROTECT CHILDREN

Keep detergents and conditioner out of the reach of children.

CHILD SAFETY CATCH ON DETERGENT COMPARTMENT

On the right in the handle of the detergent compartment there is a disengageable safety catch to prevent children from opening the compartment.

Engaging the child safety catch

To engage the child safety catch, pull the detergent compartment out a little so that you can reach the catch. Pull the catch towards you and then release it.

Child safety catch engaged

To open the compartment when the child safety catch is engaged you must push the catch to the left while pulling out the compartment.

Disengaging the child safety catch

To disengage the child safety catch, push the catch to the left and then in.

CHILD SAFETY CATCH ON TEMPERATURE KNOB

Underneath the temperature knob there is a disengageable safety catch to prevent operation by children. A flat-bladed screwdriver is needed to engage or disengage the catch.

Engaging the child safety catch

Insert the screwdriver in the hole of the catch. Press the screwdriver upwards and turn clockwise at the same time, release the catch down and turn back.

Child safety catch engaged

The child safety catch protrudes when it is engaged. To alter the temperature setting when the catch is engaged:

- push the catch up.
- turn the temperature knob to the desired setting.
- release the catch.

Disengaging the child safety catch

To disengage the child safety catch, push the catch up and turn clockwise at the same time. When the catch is at its highest position turn back so that the catch remains pressed in.

4 PARTS OF THE WASHER

1. DETERGENT COMPARTMENT

2. MAIN POWER SWITCH

3. PROGRAM PANEL

4. DATA PLATE

5. COVER - DRAIN PUMP

6. DRAIN PUMP (BEHIND THE COVER)

7. WASHER DOOR

8. OUTER DOOR

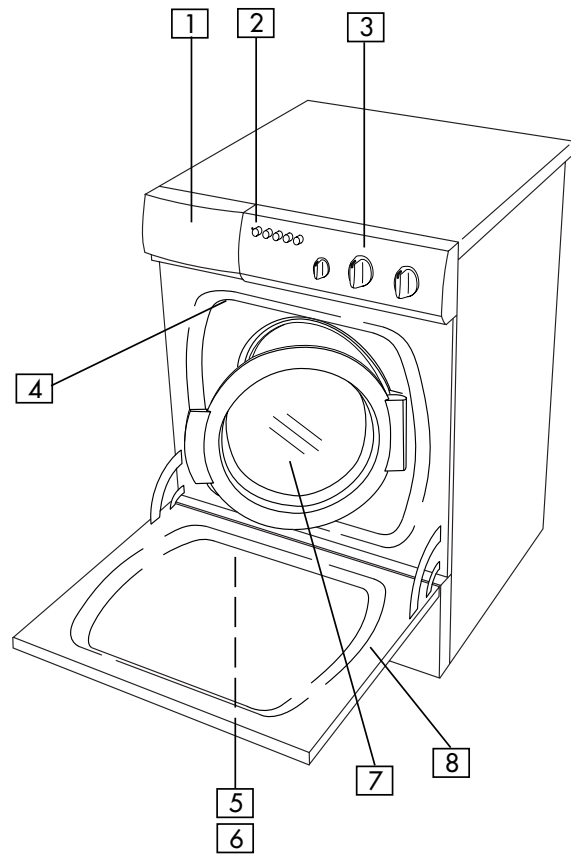

5 DETERGENT COMPARTMENT

1. DETERGENT COMPARTMENT - PRE-WASH

2. DETERGENT COMPARTMENT - MAIN WASH

3. CONDITIONER COMPARTMENT

4. PARTITION PIECE (FOR USE OF LIQUID
DETERGENT)

5. CHILD SAFETY CATCH

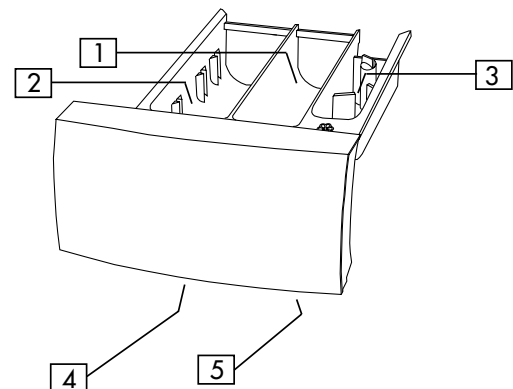

6 PANEL

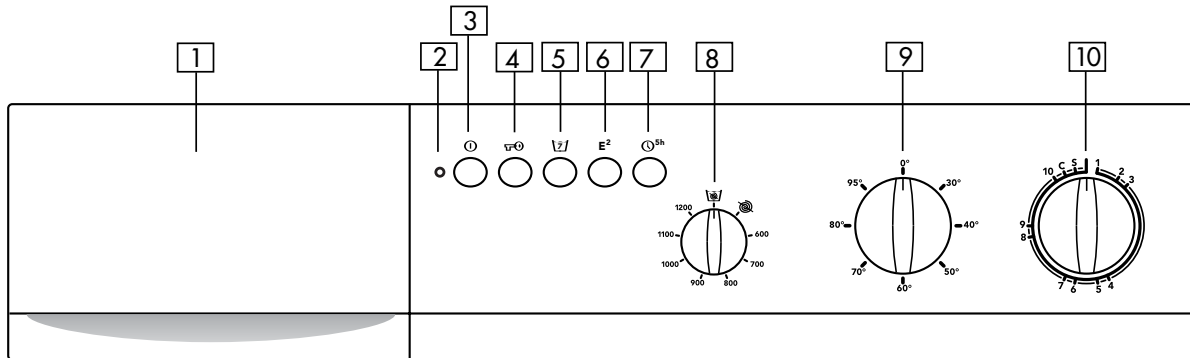

1. DETERGENT COMPARTMENT

2. INDICATING LAMP ON/OFF

3. MAIN POWER SWITCH

4. DOOR OPENING

5. SUPER RINSE

6. ECONOMY AND EFFICIENCY

7. DELAYED START - 5 HOURS

8. SPIN-DRY SELECTION KNOB

9. TEMPERATURE KNOB

10. PROGRAM KNOB

7 BEFORE WASHING

Before you start washing, here is some advice that can be useful.

SORTING THE WASHING

Sort garments in relation to:

- How soiled they are
- Colour
- Material

GARMENTS

- Close zip-fasteners so that they do not chafe against other items.
- New coloured garments can have surplus dye and should therefore be washed separately the first time.
- Turn garments inside out. This reduces the risk of burling and dye creases.
- Empty pockets and suitably let them wash turned inside out.

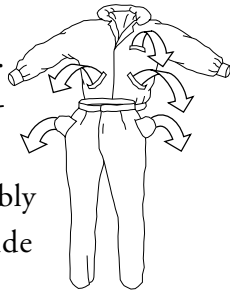

RECOMMENDED WASHING MARKING

Check the recommended washing marking on garments. The table below gives useful information on suitable washing programs for different materials and amounts of washing.

COLOURED COTTON

Coloured cotton garments marked with a recommendation for 60°C should the first time be washed at 60°C to get rid of any surplus dye. If this advice is ignored there is a risk that colours will run. Use a detergent without bleach to safeguard the colours.

DELICATE WASHING.

Unbleached linen

Unbleached linen should be washed at 60°C using a detergent without bleach or optical whitening agent. Severely soiled linen can occasionally be washed at a higher temperature, but not too often because heat can destroy the lustre and strength of linen.

Symbols in washing instructions

WASHING

LABEL	MATERIAL	PROGRAM	LOAD
	Cotton, linen, white and light colours	Normal wash 60°C to 95°C	1/1 drum
	Cotton, linen. Darker colours	Normal wash 60°C	1/1 drum
	Polyester, cotton/polyester, nylon. Whites	Synthetic wash 60°C	1/2 drum
	Rayon, acetates, acrylics. Sensitive colours	Synthetic wash 40°C	1/2 drum
	Polyesters, cotton/polyester, nylon. Colours	Synthetics wash 40°C	1/2 drum
	Silk and very delicate items	Synthetic wash 30°C	1/3 drum
	Items marked IWS and Superwash	Wool/hand wash 40°C	1/3 drum

Wool and silk

Sometimes marked machine wash and sometimes hand wash. The Wool/hand wash program of the machine is at least as gentle as washing by hand.

Wool is particularly sensitive to mechanical processing. If you wish to avoid spin drying, press out the water thoroughly using terry towels. Most garments however will tolerate a short spin dry.

Synthetic fibre

Garments made of synthetic fibre require sufficient space to avoid creasing. Fill the machine at half load when washing such items. Select short spin.

NOTE.

Viscose and acetate are brittle when wet.

MINIMIZING ALLERGY HAZARDS

This washer is provided with the Super rinse function, . Use this in taking consideration to persons who have sensitive skin, eg, allergic persons or infants.

Use this function also when dyeing any material.

ECONOMY AND EFFICIENCY

You can save a lot of energy by not using a more powerful program than is necessary.

- Choose program 7, Super quick wash, if you only need to freshen up garments, eg, shirts, tracksuits. You will save both water and energy.
- Without increasing the temperature, washing results can be improved by selecting **E²**. You then save energy without jeopardizing the

washing results.

- Select high spin speed so as to reduce total energy consumption when you intend to use a tumble dryer or drying cupboard afterwards.

DETERGENTS

Overdosing detergent will not give better results, it only increases the burden on the environment.

Try using less detergent, and increase the dose only if you are displeased with the washing results.

TEXTILE DYEING

If you want to dye textiles in the machine, select program 2, Normal wash and the Super rinse option, . Choose a temperature according to recommendations from the dye maker.

NOTE!

Bleaches or stain removers that contain the chemical $\text{Na}_2\text{S}_2\text{O}_4$, known as sodium dithionite or sodium hyposulphite, must not be used in this washing machine. If these substances are used they could cause corrosion and discoloration.

If the items being dyed are mixed material cotton/polyester then No spin, , should be selected. At the end of the program you can run program 8, Short spin, at spin speed 800 revs per minute to lightly spin dry the finished items.

NOTE.

Put the dye directly in the drum - not in the detergent compartment. After dyeing, the empty machine should be run using the same programme. Use a normal amount of detergent.

DELIBERATELY WHITE PAGE

8 WASHING

Step by step instructions to help you achieve the best washing results.

1 - PRESS THE BUTTON

Press the  button to open the door and put the washing in.

2 - PUTTING IN THE DETERGENT AND CONDITIONER

Follow the recommendations on the detergent packet for how much detergent should be used. The capacity of the machine is for 5.5 kg washing. If you put a smaller amount in the machine, you can reduce the amount of detergent accordingly.

Powder detergent

Pour in the powder for main wash (**2**) and any pre-wash (**1**).

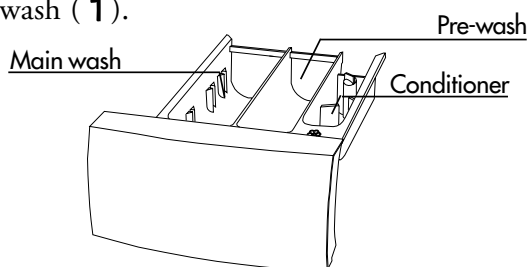

Liquid detergent

A partition piece for liquid detergent is provided, you will find it attached underneath the detergent compartment. Take it and insert it in the slot furthest in in the compartment as illustrated. Pour the detergent direct into the main wash compartment (**2**).

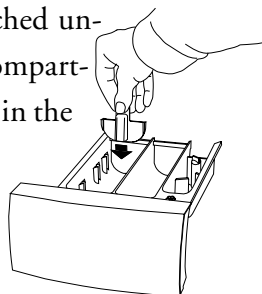

Detergent ball or dosing bag

If you are using a detergent ball or dosing bag, put it in with the washing and select a programme without pre-wash.

Conditioner

Pour conditioner in the compartment marked . Follow the maker's instructions regarding the amount.

NOTE.

Do not exceed the maximum dose level of the container, the conditioner will otherwise flow in too soon and deteriorate the washing effect.

3 - SELECTING SETTINGS AND OPTIONS

Set the knob for temperature and spin, and also press suitable option buttons for a program to suit the particular washing.

Temperature

Set the desired temperature with the temperature knob. If you choose 0°C the temperature will be the same as that of the incoming water.

Spin speed

Set the desired spin speed with the spin speed knob.

If you choose  the program will end with the final rinse water remaining in the machine. This is a suitable choice if you are unable to take the washing out promptly at the end of the program. The washing will remain floating in the rinse water and thus counteract creasing. You can later choose to run one of the spin programs 5 and 8 or the drain program 10, to drain off the rinse water.



▶

If you choose , the program will end by draining off the water but without spinning.

Options

Super rinse

Gives you a washing program with extra rinsing. Four rinses are added to programs 1 (Heavy wash), 2 (Normal wash) and 3 (Light wash). Two rinses are added to the other programs. Recommended for persons who have sensitive skin, eg, allergic persons or infants.

Also use this function when dyeing fabrics.

E² Economy and efficiency

If you choose this option the main wash will be prolonged by about 22 minutes. You can choose either an energy saving variant (I) without jeopardizing good washing results, or the variant (II) that gives an excellently effective program.

I. You can improve the washing effect by pressing **E²**. This will give you an energy saving program without jeopardizing the washing results.

II. Press **E²** and choose a higher temperature. This will give you an even more effective washing program.

Can only be selected for the programs Heavy wash, Normal wash and Light wash.

Delayed start

Press this button to delay starting 5 hours after you initiate the washing program.

NOTE.

To register this choice you must first press the main power switch in, the program knob must be in position zero (knob pointing straight up-

wards), then press this button and select the desired program.

4 - SELECTING PROGRAM

Turn the program knob to the desired program. The machine offers the following programs:

1 Heavy wash: Pre-wash - main wash - 3 rinses - short spin after the main wash and the first two rinses - long spin after the final rinse.

2 Normal wash: Main wash - 3 rinses - short spin after the main wash and the first two rinses - long spin after the final rinse.

3 Light wash: Short main wash - 3 rinses - short spin after the main wash and the first two rinses - long spin after the final rinse.

4 Rinse program: One rinse - long spin.

5 Long spin: Drain - long spin.

6 Synthetic wash: Main wash - 3 rinses - short spin after the final rinse.

7 Super quick wash: Short main wash - 2 rinses - short spin after the final rinse.

8 Short spin: Drain - short spin.

9 Wool/hand wash: Main wash (gentle action/high level of water) 3 rinses - short spin after the final rinse.

10 Drain: Drain.

C Error indication, see Chapter 11, Trouble shooting.

S Error indication, see Chapter 11, Trouble shooting.

5 - STARTING THE WASHING PROGRAM

Close the washer door and the machine will start your washing program.

Putting in more washing

Turn the program knob to position 10, Drain, to interrupt the washing program. Any water in the machine will be pumped out. Press the  button to open the door.

Put the extra washing in, fill new detergent if needed, close the door, set a new program and the machine will start.

Altering settings or changing the program

Press the option buttons in/out that you wish to alter and turn the program knob to the desired program.

NOTE.

To alter the option Delayed start, you must first turn the program knob to zero (knob pointing straight upwards), then press the  button and turn the program knob to the desired program position.

6 - WASHING PROGRAM COMPLETED

Press the  button and take out the washing.

7 - WHEN WASHING IS FINISHED

Turn OFF the main switch, , and close the washer door.

DELIBERATELY WHITE PAGE

9 CONSUMPTION VALUES

The following conditions apply for the consumption values indicated below:

Temperature of incoming water: 20°C.

Element power: 2200 W, 240 V.

Options: None

PROGRAM	MATERIAL/WASHING TEMPERATURE	LOAD	WATER CONSUMPTION (approx. litre)	POWER CONSUMPTION (approx. kWh)	PROGRAM TIME (approx. minutes)
1 Heavy wash	Cotton, linen, 60°C	1/1 (5.5 kg)	59	1.10	134
2 Normal wash	Cotton, linen, 60°C	1/1 (5.5 kg)	56	0.90	110
3 Light wash	Cotton, linen, 40°C	1/1 (5.5 kg)	56	0.30	55
6 Synthetic wash	Polyester, cotton/ polyester, nylon, 40°C	1/2 (2.5 kg)	28	0.30	60
7 Super quick wash	Non-iron, cotton/ polyester, 40 °C	1/2 (2.5 kg)	22	0.30	35
9 Wool/ hand wash	Wool/hand wash, IWS, Superwash, 30°C	1/3 (1.7 kg)	53	0.25	39

10 CARE AND CLEANING

CLEANING THE NEEDLE TRAP AND THE DRAIN PUMP

The washing machine has a trap in which coins, hairpins and similar items fasten. Clean the needle trap and the drain pump as follows:

1. Ensure that the machine is drained and the main power switch is turned OFF.

2. Open the drain pump cover. Use the partition piece from the detergent compartment, as illustrated.

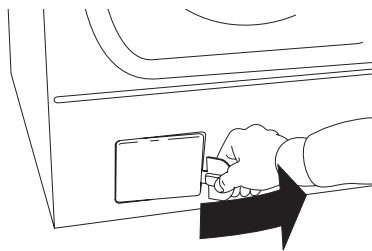

3. Drain off the water, eg, in a bowl, by pulling loose the drain hose from its connection on the inside of the cover.

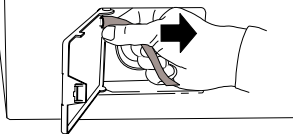

4. Open the pump by screwing its cover anticlockwise. Lift off the cover together with the needle trap.

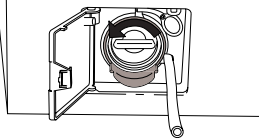

5. Clean out any objects and foreign matter from the pump housing. Ensure that the pump blade, at the rear, can be rotated.

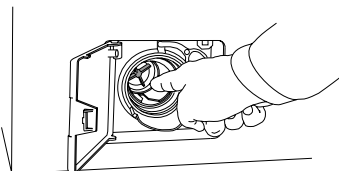

6. Screw on the cover together with the needle trap, put the drain hose back on its connection and close the cover.

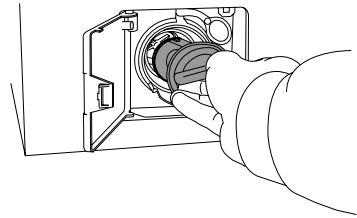

CLEANING THE DETERGENT COMPARTMENT

Pull out the detergent compartment as far as it goes.

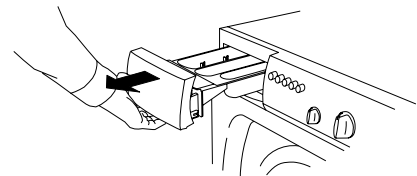

Then pull upwards and outwards as illustrated.

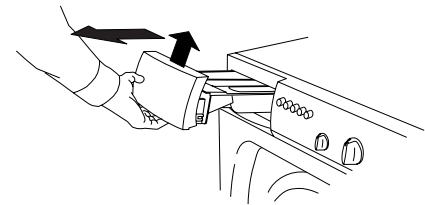

Flush and brush the detergent compartment. Put the detergent compartment back in.

NOTE.

Do not wash the detergent compartment in a dishwasher.

CLEANING THE OUTSIDE OF THE MACHINE

Use a mild detergent to clean the outside of the machine. Do not use any solvents, they can damage the machine.

NOTE

Do not spray the machine with water.

CLEANING HOLES UNDER THE RIDGES

If you suspect that objects, eg, nails, paperclips, pins and so on, have fallen through the washing drum you should check the space underneath the ridges. Such items can corrode and cause rust stains on your washing. Nails and other sharp objects can tear fabrics.

Proceed as follows:

1. Use a screwdriver or similar tool.

2. Insert the screwdriver in the middle hole in the ridge and carefully push the screwdriver handle to the left.

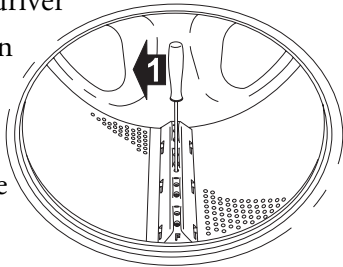

3. Grip the ridge with your other hand and pull it towards you as illustrated.

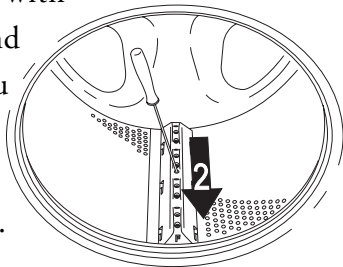

4. Lift up the ridge.

5. Remove any objects.

6. Position the ridge in the fixing holes with the F-mark facing you. Ensure that the ridge lugs fit firmly in their holes in the drum. Slide away from you until it stops.

HARD WATER

If you live in an area that has hard water, the washer drum may become coated with a grey-white deposit. To get rid of the deposit, pour a packet of citric acid, about 20 gram, in the drum and run the Normal wash program at 95°C. You will find citric acid on the spice shelf in your grocer's store.

11 TROUBLE SHOOTING

MACHINE WILL NOT START

1. Is the door properly closed? Press it shut firmly.
2. Check to make sure that the button for Delayed start, , is not pressed in.
3. Is power cut off? Check the fuses.

DOOR WILL NOT CLOSE

If the door opens again immediately when you try to close it, check to make sure that you have made correct program settings. If this does not help then there is probably a safety fault. Phone service.

DOOR WILL NOT OPEN

1. Check that the main switch is ON and that the program knob is at the zero position (should be pointing straight up).
2. Is the power supply cut off? Check the fuses. The door cannot be opened using the  button if the power supply is broken.
3. If the door cannot be opened in the normal manner, proceed as follows to make an emergency opening:

- Check first that there is no water left in the machine. If there is, drain the machine as explained under the heading, Cleaning the needle trap and drain pump, in Chapter 10, Care and cleaning.
- Make certain that the main power switch is OFF.

- Open the drain pump cover, down to the left. Use the partition piece from the detergent compartment, as illustrated.

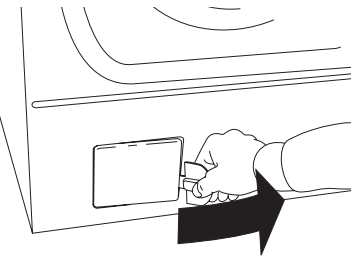

- Unscrew the screw holding the red plastic handle in place.

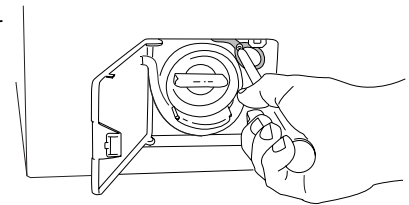

- Pull the handle and the door will open.

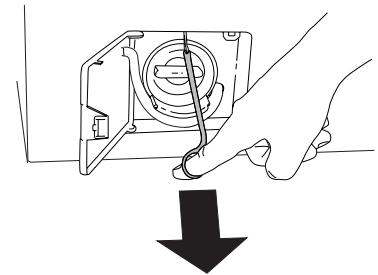

- Put the handle into its slot and screw it into place. Close the drain pump cover.

If the door still cannot be opened in the normal way after this, phone for service.

FAULT INDICATION

Faults that occur while a program is running will be indicated by the program knob moving to its position **C** or **S** at the end of the program or when it is interrupted.

Knob moves to position S at end of program or when interrupted

This indicates motor fault or level sensing error during the program. Phone service.

Knob moves to position C at end of program or when interrupted

This indicates that an error occurred during the program. Before calling for service, check to see whether the fault is due to something that you can put right yourself. Proceed as follows:

- 1 Is power supply broken? Check fuses. If you replace a fuse, run program 7, Super quick wash, at 60°C without load, ie, to check that the fault has been corrected.

- 2 If there is water remaining in the machine. Make sure that the Spin knob is not in  position. Then run program 10, Drain. If the water is not pumped out, phone service.

- 3 Is the machine drained or have you drained the machine according to item 2 above? Set the knob to zero, ie, pointing straight up, and open the door.

If the washing is not wet, after the program is interrupted, the machine has obviously not taken in water. Check the following:

- water is open.

- strainer in the water intake is not clogged. If it is clogged, proceed as follows:

1. Turn off the water tap.
2. Disconnect the hose.
3. Clean the strainer in the water intake of the machine.
4. Re-connect the hose.
5. Open the water tap.
6. Run the program again to check that the fault is remedied.

If the washing is wet, but not spin-dried, check the following:

- The machine incorporates an out-of-balance detector, which reduces spin speed or prevents spinning from starting if the load is very unbalanced. Open the door and redistribute the washing. Start again by selecting the Short spin program.

- Check the drain hose and the drain pump.

1. Straighten out any kinks in the drain hose.
2. Is there anything stuck in the drain hose outlet? Clear the hose.
3. Is the drain pump blocked by foreign objects? Clear the pump, see Chapter 10, Care and cleaning.

If the knob still moves to position **C**, despite the above measures being taken, phone service.

12 TECHNICAL INFORMATION

TECHNICAL DATA

Height:	850 mm.
Width:	595 mm.
Depth:	585 mm.
Weight:	78 kg.
Drum volume:	50 litre.
Washing capacity:	5.5 kg.
Spin speed, r/min:	600 - 1200 rpm.
Rated power, connection:	See data plate.
Rated power, element:	See data plate.
Water pressure:	0.1 - 1 MPa. 1 - 10 kp/cm ² . 10 - 100 N/cm ² .
Material: Washing drum and fluid container	Stainless steel.
Material: Outer cover	Powder-lacquered and hot-galvanized steel sheet or stainless steel.
Positioning:	Stationary on four adjustable, rubber-coated feet.
Water connection:	1.5 m PEX tube.
Drain:	1.7 polypropylene hose.

STANDARD TESTS

Australia:	AU/NZS 2040.1:1998.
Washing program:	Program 2 (Normal wash), 40°C, 5.5 kg mixed cotton, 1200 rpm.
Connection:	Cold water supply.
Procedure for acoustic measurement:	IEC 60 704-2-4.

13 SERVICE AND GUARANTEE

SERVICE

Before calling for service, check to see whether the fault is due to something that you can put right yourself. See chapter 13, Trouble shooting.

If you do require service, telephone your local ASKO retailer or the ASKO representative for your country. See guarantee card for address and telephone number.

GUARANTEE

For guarantee details, see the guarantee card.

14 QUICK GUIDE

1. SORT THE WASHING.

2. PRESS THE MAIN POWER SWITCH, , AND OPEN THE DOOR, .

Load the washing.

3. FILL WITH DETERGENT AND CONDITIONER AS REQUIRED.

Detergent (main wash) to the left (**2**), detergent if required (pre-wash) in the middle section (**1**) and conditioner to the right (). If liquid detergent is used the partition piece, attached underneath the detergent compartment, is to be inserted in the inner slot of the compartment.

4. SELECT SETTINGS, OPTIONS AND PROGRAM.

5. CLOSE THE DOOR.

The washing program starts.

6. AFTER WASHING.

Turn the main switch, , OFF and close the door.

Program	Temperature (°C)	Options	Spin speed	Amount of washing
1 Heavy wash	60-95		600-1200	1/1
2 Normal wash	60	E ²	600-1200	1/1
2 Normal wash	40	E ²	600-1200	1/1
2 Normal wash	40-60		600-1200	1/1
2 Normal wash	40	E ²	600-1200	1/1
3 Light wash	40		600-1200	1/2
6 Synthetic wash	60		600-800	1/2
7 Super quick wash	30-40		600-1200	1/2
9 Wool/hand wash	30-40		600-800	1/3

Washing description	Program	Temperature (°C)	Options	Spin speed	Amount of washing
Items marked IWS, Superwash or Hand wash.	9	30-40		600-800	1/3
Washing that only needs a quick freshener, eg, shirts, tracksuits.	7	30-40		600-1200	1/2
Polyester, cotton/polyester, nylon. White garments.	6	60		600-800	1/2
Slightly soiled cotton or linen.	3	40		600-1200	1/2
Cotton, linen. Darker coloured garments. Economy program.	2	40	E ²	600-1200	1/1
Cotton, linen. Darker coloured garments.	2	40-60		600-1200	1/1
Cotton, linen. Darker coloured garments. Super efficiency program.	2	40	E ²	600-1200	1/1
Cotton, linen, white and light coloured garments. Economy program.	2	60	E ²	600-1200	1/1
Cotton, linen, white and light coloured garments. Super efficiency program.	2	60-95		600-1200	1/1
Severely soiled washing, eg, working clothes.	1	60-95		600-1200	1/1

15 INDEX

	Chapter		Chapter		Chapter
Acetate	7	Hand wash	7,8,14	Rinsing program	8
Acrylate	7	Hardness of water	1	Safety rules	2
Allergy	7,8	Hard water	10	Selecting program	8,14
Altering settings after starting	8	Heavy washing	8,14	Service	13
Amount of washing	7,14	Height	12	Short spin	7,8
Bleach	7	Installation, see Installation		Silk	7
Burling	7	instructions		Sorting the washing	7
		Interrupting a program	2	Spin drying	7,8,11,12,14
Care	10			Spin speed	8,12
Children's safety	3	Light wash	8,14	Start	8
Cleaning hole	10	Linen	7,14	Stop	8
Cleaning	10	Liquid detergent	8	Strainer	10
Colours	7			Super quick wash	8,14
Conditioner	5,8,14	Main power switch	8,14	Super rinse	8
Consumption values	9	Material	7,14	Synthetic fibre	7
Cotton	7,14			Synthetic fibre	7
Cover, drain pump	4,10,11	Needle trap	10	Synthetic wash	7,8,14
Crease free, see No drain		No drain	8	Technical information	12
		No spin	8	Temperature	7,14
Data plate	4	Normal wash	7,8,14	Textile dyeing	7
Delayed starting	8	Nylon	7	Time	9
Delicate garments	7			Towelling	7
Delicate washing	7	Options	8	Transport support	1
Depth	12	Overfill protection	2	Transport	2
Detergent bag	8			Trouble shooting	11
Detergent ball	8	Packing material	2	Unbalance	11
Detergent compartment	5,8	Panel	6		
Detergent	7,8	Partition piece	5,8	Viscose	7
Disposal	2	Parts of the washing machine	4		
Door opening, see Washer door		Pockets	7	Washer door	2,4,11
Door, see Washer door		Polyester	7	Washing capacity	8,12
Dosage	8	Powder detergent	8	Washing ridge	10
Drain hose	10	Power consumption	9	Washing	8,14
Drain pump	10	Pre-wash detergents	5,8,14	Weight	12
Drain	8	Pre-wash	8	White washing	7,14
Dyeing, see Textile dyeing		Programs, see Wash programs		Width	12
E²	7,8	Quick guide	14	Winter storage	2
Emergency stop, see Interrupt program				Wool washing	7,8,14
Error indications	11	Rayon	7		
		Recommended washing	7	Zip fasteners	7
Guarantee	13	marking	7		

