

This Owner's Manual is provided and hosted by [Appliance Factory Parts](http://www.appliancefactoryparts.com).

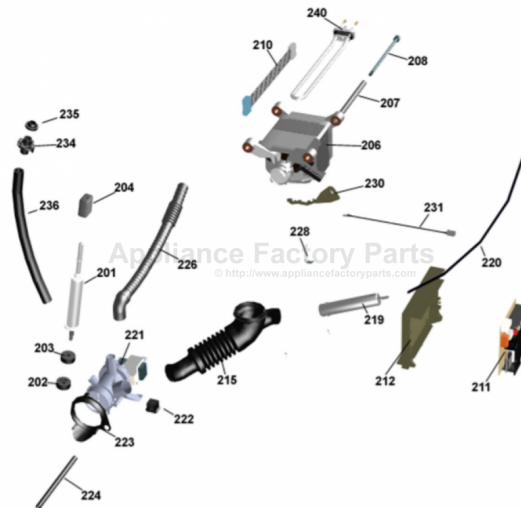

ASKO W640 Owner's Manual

[Shop genuine replacement parts for ASKO W640](#)



[Find Your ASKO Washer Parts - Select From 53 Models](#)

----- Manual continues below -----

Washing Machine W640

DEAR ASKO CUSTOMER

Welcome to the family of ASKO customers. We hope that you will get many years of good use of your new washing machine. The washing machine is very sophisticated. In order to get best possible use of your machine and all its functions we recommend you to read this Use and Care Guide before you use the washing machine.

CONTENTS

READ FIRST

- 1 Before washing the first time** 3
- 2 Safety instructions** 4-5
General. Installation. Washer door. Overfill protection. Interrupting a program. Packing material. Transport/Winter storage. Disposal.
- 3 Children's safety** 6
Child-safe washing. Protect children. Child safety catch on detergent compartment. Child lock on Start/Stop and Menu buttons.
- 4 Parts of the washer** 7
- 5 Detergent compartment** 7
- 6 Panel** 8
- 7 LC Display** 8

INSTALLATION

See instructions for installation.

WASHING

- 8 Before washing** 9-11
Sorting the washing. Garments. Recommended washing marking. Coloured cotton. Delicate washing. Super rinse. Economy and efficiency. Detergents. Textile dyeing. Washing time.
- 9 Washing** 12-15
Main power switch. Open the door. Putting in the washing. Select program. Temporary alterations. Starting the washing program. Putting in more washing. Changing settings after starting.

Changing the program. Washing program completed. When washing is finished.

- 10 Consumption values - Pre-set washing programs** 16
- 11 Making own washing programs** 17-23
Selecting initial program. Programs. Temperature. Spin speed. Delayed start. Options. Short cuts. Restoring pre-set program.

CARE

- 12 Care and Cleaning** 24-25
Cleaning the needle trap and drain pump. Cleaning the detergent compartment. Cleaning the outside of the machine. Clean-out recess under the ridges. If you have hard water.

PROBLEMS?

- 13 Trouble shooting** 26-27
Door will not open. Machine will not start. No water entering the machine when it starts. Water in the machine after the final spin or pump out. Fault indications. Wrong language on the display. Temperature - Celsius or Fahrenheit.

MISCELLANEOUS

- 14 Technical information** 28
Technical data. Standard tests.
- 15 Service and guarantee** 29
- 16 Quick guide** 30
- 17 Index** 31

1 BEFORE WASHING THE FIRST TIME

CAUTION WITH CERTAIN MATERIALS

Always check and adhere to recommended washing marking on the items concerned. If no recommendations are given, refer to those in chapter 8, Before washing.

TRANSPORT SUPPORTS

Are the transport supports (three screws at the back of the machine) removed? If not, see the Installation instructions.

WASHER DOOR

The door of the washer opens electrically. Consequently, the door cannot be opened normally until the machine is connected to an electric power supply. However, emergency opening is available, see chapter 13, Trouble shooting.

CHECK HARDNESS OF THE WATER

Call your local water company to find out what degree of water hardness applies. This has significance in relation to the amount of detergent that should be dispensed.

2 SAFETY INSTRUCTIONS



GENERAL

- Study and save this Use and Care Guide for future reference.
- Electrical and water installation, if required, must be carried out by authorized persons.
- The machine may only be used for washing in accordance with these operating instructions - not for dry cleaning.
- Use only detergents intended for machine washing.
- Remove the transport supports before using the machine, see installation instructions.

INSTALLATION

See the accompanying installation instructions.

WASHER DOOR

The door of the washer opens electrically. Consequently, the door cannot be opened normally until the machine is connected to an electric power supply.

To open the door manually, see the heading, Door will not open, in chapter 13, Trouble shooting.



The machine cannot be started with the door open.

To open the door during an ongoing program, see below, Interrupting a program.

OVERFILL PROTECTION

If the level of water in the machine rises above normal, the overflow protection will start to pump out water and shut off the water supply. The program will be interrupted if the level does not fall within 60 seconds.

INTERRUPTING A PROGRAM

To interrupt a washing program, hold the  button pressed for three seconds, or press the main power switch . The machine will "remember" where in the program it was when stopped. If you wish to continue the washing process, just close the door and press the  button and the machine will start where it was interrupted.

You can also interrupt a program by pressing  for three seconds. However, if you stop the machine in this way it will forget where it was in the program and you will have to select a program to restart.

PACKING MATERIAL

Sort the packing material for recycling according to recommendations by the local authorities.

TRANSPORT/WINTER STORAGE

If the machine is to be transported or stored during the winter, on unheated premises, empty the needle trap and the drain pump, see chapter 12, Care and Cleaning.

If you have any questions, please phone your retailer.

DISPOSAL

When the machine is no longer useful and is to be scrapped it should be made unusable.

Get in touch with the refuse collection service or your local authorities for advice on how to scrap the machine in a proper manner.

The machine is made and marked to facilitate recycling.

3 CHILDREN'S SAFETY



CHILD-SAFE WASHING

Always close the washer door and start the program immediately after filling the detergent.

Do not allow children to play with the washing machine.

PROTECT CHILDREN

Keep detergents and conditioner out of the reach of children.

CHILD SAFETY CATCH ON DETERGENT COMPARTMENT

On the right in the handle of the detergent compartment there is a disengageable safety catch to prevent children from opening the compartment.

Engaging the child safety catch

To engage the child safety catch, pull the detergent compartment out a little so that you can reach the catch. Pull the catch towards you and then release it.



Child safety catch engaged

To be able to open the compartment when the child safety catch is engaged you must push the catch to the left while pulling out the compartment.

Disengaging the child safety catch



To disengage the child safety catch, push the catch to the left and then in.



CHILD LOCK ON AND BUTTONS

By locking the  and  buttons, you can prevent that for example a child starts the machine or changes the settings by mistake.

Child lock On/Off

Turn the main power switch, , off and then turn it on again.



Press the  button five times, then press the  button five times. These ten times must be completed within fifteen seconds.

Within three seconds after the last press on the  button, use the   buttons to choose Child lock ON (the figure 3 will appear at the bottom right in the display) or OFF (the figure 0 will appear at the bottom right in the display).

To start a program with locked button.

Press the  button for three seconds and the machine will start.

To change program settings with Child locked button.

Press the  button for three seconds, after that the  button works normally again. If you do not press any button within two minutes, the  button will be locked again.

NOTE

If you want to change the settings after you have started a program, you always have to press the  button for three seconds.

4 PARTS OF THE WASHER

1. DETERGENT COMPARTMENT

2. MAIN POWER SWITCH

3. PROGRAM PANEL

4. DATA PLATE

5. COVER - DRAIN PUMP

6. DRAIN PUMP (BEHIND THE COVER)

7. WASHER DOOR

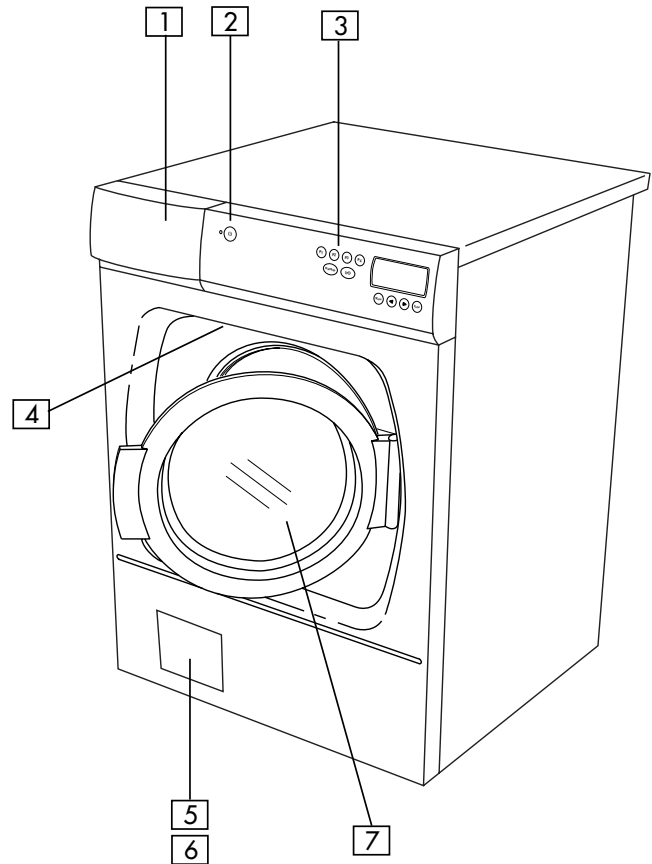

5 DETERGENT COMPARTMENT

1. DETERGENT COMPARTMENT - PRE-WASH

2. DETERGENT COMPARTMENT - MAIN WASH

3. FABRIC CONDITIONER COMPARTMENT

4. PARTITION PIECE (FOR USE OF LIQUID
DETERGENT)

5. CHILD SAFETY CATCH

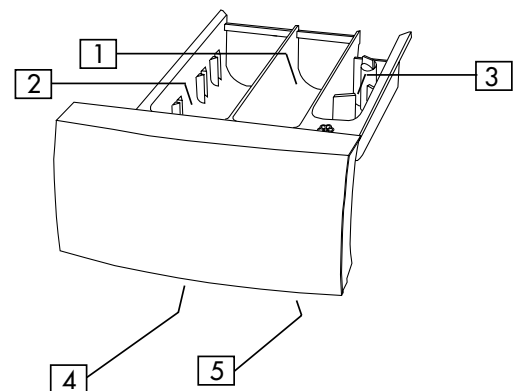

6 PANEL

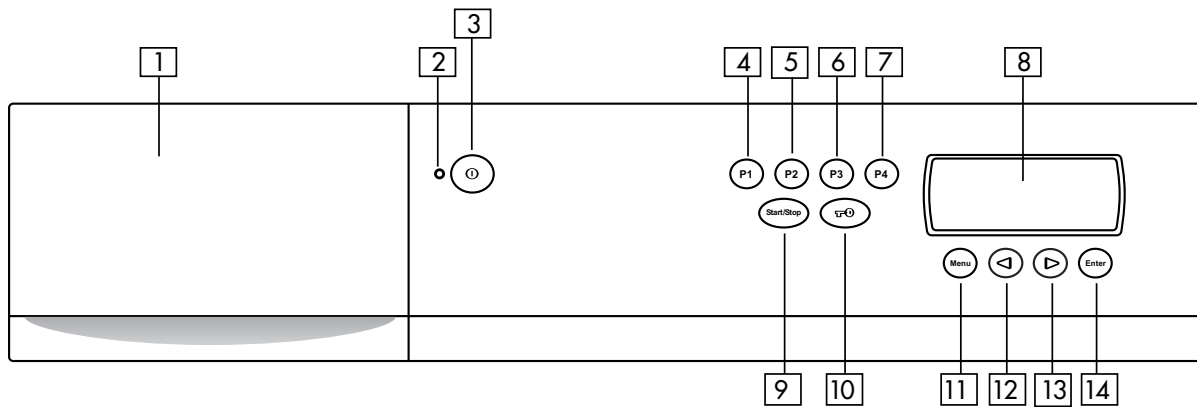

1. DETERGENT COMPARTMENT

2. INDICATING LAMP ON/OFF

3. MAIN POWER SWITCH

4. PROGRAM SELECTION BUTTON 1

5. PROGRAM SELECTION BUTTON 2

6. PROGRAM SELECTION BUTTON 3

7. PROGRAM SELECTION BUTTON 4

8. LC DISPLAY

9. START/STOP BUTTON

10. DOOR OPENING BUTTON

11. MENU BUTTON

12. STEP BACKWARD/CHANGE TEMPERATURE

13. STEP FORWARD/CHANGE SPIN SPEED

14. ENTER BUTTON

7 LC DISPLAY

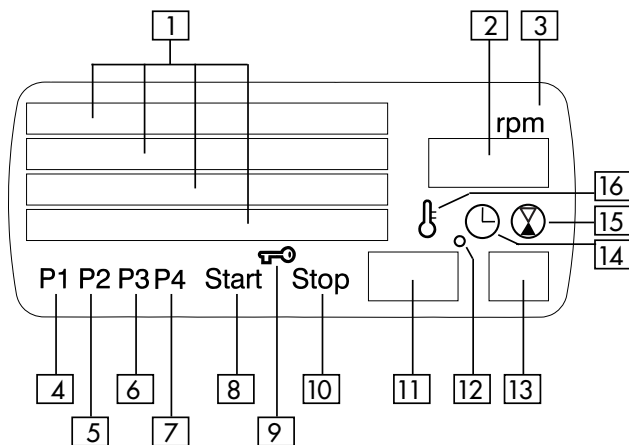

1. TEXT FIELD, SHOWING PROGRAMS, OPTIONS, ERROR MESSAGES, ETC.

2. SHOWING SELECTED SPIN SPEED

3. INDICATES THAT [2] SHOWS SELECTED SPIN SPEED

4. INDICATES THAT SELECTED PROGRAM IS P1

5. INDICATES THAT SELECTED PROGRAM IS P2

6. INDICATES THAT SELECTED PROGRAM IS P3

7. INDICATES THAT SELECTED PROGRAM IS P4

8. INDICATES THAT A PROGRAM HAS STARTED

9. INDICATES THAT WASHER DOOR IS OPEN OR WILL OPEN

10. INDICATES THAT A PROGRAM IS COMPLETED OR STOPPED

11. AND [12] SHOWS SELECTED WASHING TEMPERATURE

13. SHOWS TOGETHER WITH [14] THE NUMBER OF HOURS FOR DELAYED START AND TOGETHER WITH [15] THE REMAINING PROGRAM TIME

14. INDICATES THAT [13] SHOWS DELAYED STARTING

15. INDICATES THAT [13] SHOWS REMAINING PROGRAM TIME

16. INDICATES THAT [11] SHOWS THE TEMPERATURE

8 BEFORE WASHING

Before you start washing, here is some advice that can be useful.

SORTING THE WASHING

Sort garments in relation to:

- How soiled they are
- Colour
- Material

GARMENTS

- Close zip-fasteners so that they do not chafe against other items.
- New coloured garments can have surplus dye and should therefore be washed separately the first time.
- Turn garments inside out. This reduces the risk of burling, dye creases, etc.
- Empty pockets and suitably let them wash turned inside out.

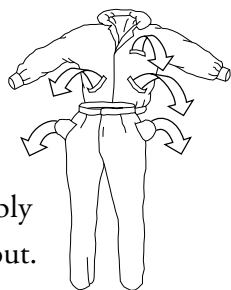

RECOMMENDED WASHING MARKING

Check the recommended washing marking on garments. The table below gives useful information on suitable washing programs for different materials and amounts of washing.

COLOURED COTTON







Coloured cotton garments marked with a recommendation for 60°C should the first time be washed at 60°C to get rid of any surplus dye. If this advice is ignored there is a risk that colours will run. Use a detergent without bleach to safeguard the colours.

DELICATE WASHING

Unbleached linen

Unbleached linen should be washed at 60°C using a detergent without bleach or optical whitening agent. Severely soiled linen can occasionally be washed at a higher temperature, but not too often because heat can destroy the lustre and strength of linen.

Symbols in washing instructions

WASHING LABEL	MATERIAL	PROGRAM	LOAD
	Cotton, linen, white and light coloured garments.	Normal wash 60° to 95°	1/1
	Cotton, linen. Darker coloured garments.	Normal wash 60°	1/1
	Polyester, cotton/polyester, nylon. White garments.	Synthetic wash 60°	1/2
	Rayon, acetates, acrylics. Garments with more sensitive colours.	Synthetic wash 40°	1/2
	Polyester, cotton/polyester, nylon. Coloured garments.	Synthetic wash 40°	1/2
	Silk and very delicate garments.	Synthetic wash 30°	1/3
	Garments marked IWS or Superwash	Wool/hand wash 40°	1/3





Wool and silk

Sometimes marked machine wash and sometimes hand wash. The Wool/hand wash program of the machine is at least as gentle as washing by hand.

Wool in particular is sensitive to mechanical processing. If you wish to avoid spin drying, press out the water thoroughly using terry towels. Most garments however can tolerate a short spin dry.

Synthetic fibre

Garments made of synthetic fibre require sufficient space to avoid creasing. Fill the machine at half load when washing such items. Select short spin.

NOTE

Viscose and acetate are brittle when wet.



SUPER RINSE

This washing machine is provided with the Super rinse function. Super rinse adds extra rinses to your washing program. To the programs Heavy wash, Normal wash and Light wash four extra rinses are added. To the others, two rinses are added. Choose Super rinse ON if at any time you want especially thorough rinsing.

Use this function also when dyeing any material. See chapter 11, Making own washing programs, to select Super rinse ON.

ECONOMY AND EFFICIENCY

You can save a lot of energy by not using a more powerful program than is necessary.

- Choose Super Quick wash, program 3, if you

only need to freshen up garments, eg, shirts and tracksuits. You will save both water and energy.

- Without increasing the temperature, washing results can be improved by selecting E2: Eco/Efficiency ON. You then save energy without jeopardizing the washing results. See chapter 11, Making own washing programs, to select E2: Eco/Efficiency ON.
- Select high spin speed to reduce energy consumption when using a tumble dryer or drying cupboard. See Temporary alterations in chapter 9, Washing.

DETERGENTS

Overdosing detergent will not give better results, it only increases the burden on the environment.

Try using less detergent, and increase the dose only if you are displeased with the washing results.

TEXTILE DYEING

If you want to dye textiles in the machine, select the Normal wash program and the Super rinse option ON. Choose a temperature according to recommendations from the dye maker.

NOTE!

Bleaches or stain removers that contain the chemical $\text{Na}_2\text{S}_2\text{O}_4$, known as sodium dithionite or sodium hyposulphite, must not be used in this washing machine. If these substances are used they could cause corrosion and discoloration.

If the items being dyed are mixed material cotton/polyester a short spin dry at 800 revs per minute should also be selected. See chapter

11, Making own washing programs (Super rinse) and chapter 9, Washing - Temporary alterations (Spin speed), to see how these selections are made.

NOTE

Put the dye directly in the drum - not in the detergent compartment. After dyeing, the empty machine should be run using the same programme. Use a normal amount of detergent.

WASHING TIME

The  -symbol indicates that the remaining washing time is shown at the bottom right in the display within ten minutes after the washing program starts.

When a program is chosen the washing time is calculated. The calculated washing time can vary from time to time due to the temperature of incoming water.

Before the last rinse the remaining time is recalculated and can then be decreased or increased.

9 WASHING

PRESS THE BUTTON

The display will then show the four pre-set programs. If no button is pressed within three minutes the display will go out. The display will light again when one of the buttons is pressed. If the language on the display becomes altered for any reason, see chapter 13, Trouble shooting.

OPEN THE DOOR

Press the  button and put the washing in.

PUTTING IN THE WASHING AND DETERGENT

Follow the recommendations on the detergent packet for how much detergent should be used. The capacity of the machine is for 5.5 kg washing. If you put a smaller amount in the machine, you can reduce the amount of detergent accordingly.

The partition piece provided should be used for liquid detergent only, see below.

Powder detergent

Pour in the powder for main wash (**2**) and any pre-wash (**1**), see figure.

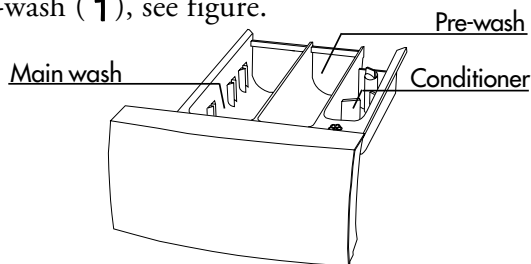

Liquid detergent

Underneath the detergent compartment you will find a partition piece for liquid detergent. Take it and in-

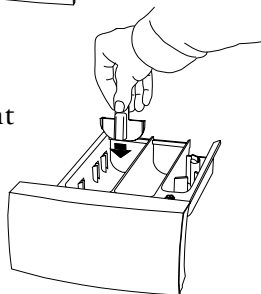

sert it in the slot furthest in in the compartment as illustrated. Pour the detergent directly into the main wash compartment (**2**).

Detergent ball or dosing bag

If you are using a detergent ball or dosing bag, load it directly with the washing and select a programme without pre-wash.



Fabric conditioner

Pour conditioner in the compartment marked . Follow the maker's instructions.



NOTE



Do not exceed the maximum dose level of the container, the conditioner will otherwise flow in too soon and deteriorate the washing effect.



SELECTING PROGRAM

Select one of the pre-set programs  to .

Pre-set washing programs

 -Normal wash,  , 1400 r/min, main wash, three rinses, short spin dry after the main wash and the first two rinses and a long spin dry after the final rinse.

 -Normal wash,  , 1400 r/min, main wash, three rinses, short spin dry after the main wash and the first two rinses and a long spin dry after the final rinse.

 -Super Quick wash,  , 800 r/min, main wash, two rinses and short spin dry.

 -Wool/hand wash,  , 800 r/min, main wash, three rinses and short spin dry.

PROGRAM BUTTON	PROGRAM	TEMPERATURE (°C)	SPIN SPEED (RPM)	DELAYED START (h)	OPTIONS					
					Pre-soak	Quick main wash	E2: Eco/ Efficiency	Super rinse	Short spin	Spin
P1	NORMAL WASH	60*	1400**	0	OFF	OFF	OFF	OFF	ON	ON
P2	NORMAL WASH	40*	1400**	0	OFF	OFF	OFF	OFF	ON	ON
P3	SUPER QUICK WASH	40*	800*	0	OFF	OFF	OFF	ON	ON	ON
P4	WOOL/HAND WASH	30*	800**	0	OFF	OFF	OFF	OFF	ON	ON

Settings of the four pre-set programs. *) Means that you can make temporary alterations to these settings. **) Means that the settings are maximum values in the program and that if you make temporary alterations you can only choose lower values for these settings. To alter other settings, see, Making own washing programs.

You can adjust Temperature and Spin speed in the pre-set programs according to Temporary alterations, below.

You can also alter the contents (program, options, etc.) of the pre-set programs to suit your particular requirements, see chapter 11, Making own washing programs.

TEMPORARY ALTERATIONS

After selecting one of the pre-set programs (P1) to (P4) you can adjust the program to suit your particular washing in the best way. These alterations return to the initial settings at the end of the washing program. To make permanent alterations in the programs, see chapter 11, Making own washing programs.

Temperature

You can select a washing temperature C (cold), or between 30°C and 95°C. If you choose C the temperature will be the same as that of the incoming water.

For the Wool/hand wash program it is not possible to choose a temperature higher than 40°C.

With the  button, step to the desired temperature.

When you step to the desired temperature it will be shown at the lower edge of the display together with the  symbol. After stepping to the maximum temperature the counter will start again at the lowest temperature.

Spin speed

You can select spin speeds between 600 and



1400 r/min.

For the programs Synthetic wash and Wool/hand wash it is not possible to select higher speed than 800 r/min.

With the  button, step to the desired spin speed.

When you step to the desired speed it will be shown at the upper right corner of the display together with the rpm symbol. After stepping to the highest speed the counter will start again at the lowest speed.

STARTING THE WASHING PROGRAM

After completing your settings you can start the washing program. Make certain the door is closed and then press the  button.

The text **Start** at the lower edge of the display indicates that the program has started. The text field of the display shows the current stage of the program while it is in progress.

The remaining washing time is shown at the bottom right in the display within ten minutes after the washing program starts.

When a program is chosen the washing time is calculated. The calculated washing time can vary from time to time due to the temperature of incoming water.

Before the last rinse the remaining time is recalculated and can then be decreased or increased.

PUTTING IN MORE WASHING

If you decide to put in more washing after starting the machine, hold the  button pressed for three seconds. Any water in the machine

will be pumped out and the door will then open. Put the extra washing in and close the door and the washing program will start automatically where it was interrupted.

CHANGING SETTINGS AFTER STARTING

It is possible to alter some settings after you have started a washing program. However, to make any alterations it is necessary that the part of the program that you wish to alter has not become activated. The settings that can be altered are:

- E2: Eco/Efficiency - Can be altered before cooling or pumping out of water from the main wash begins.
- Super rinse - Can be altered before the final rinse begins.
- Short spin - Can be altered before the final spin begins.
- Spin - Can be altered before spinning begins.
- Temperature - Can be altered before the heating phase.
- Spin speed - Can be altered before the final spin sequence begins.

As a precaution it is necessary that you hold the  button pressed for three seconds to enable settings to be altered. You can then alter the desired settings according to Temporary alterations or in the manner described in chapter 11, Making own washing programs.

CHANGING THE PROGRAM

Press the  button for three seconds. The program will then be zero set and you can choose a new program.

WASHING PROGRAM COMPLETED

Press the  button and take out the washing.

WHEN WASHING IS FINISHED

Turn off the main switch, , and close the washer door.

10 CONSUMPTION VALUES - PRE-SET PROGRAMS

The following conditions apply for the consumption values indicated below:

Temperature of incoming water: 20°C.

Element power: 2200 W, 240 V.

PROGRAM	WASHING/ TEMPERATURE	AMOUNT OF WASHING	WATER CONSUMP- TION (ca litre)	ENERGY CONSUMP- TION (ca kWh)	PROGRAM TIME (ca minutes)
P1 Normal wash	Cotton, linen, 60 °C	1/1 (5.5 kg)	56	0.90	115
P2 Normal wash	Cotton, linen, 40 °C	1/1 (5.5 kg)	56	0.35	95
P3 Super quick wash	Polyester, cotton/poly- ester, 40 °C	1/2 (2.5 kg)	22	0.30	35
P4 Wool/ hand wash	Wool/hand wash, IWS, Superwash, 30 °C	1/3 (1.7 kg)	53	0.25	39





11 MAKING OWN WASHING PROGRAMS

You can make your own washing programs that perhaps suit your requirements better than the four pre-set programs.



It is always possible to restore the initial pre-set programs. See the heading at the end of this chapter, Restoring pre-set programs.

There is a flow chart on the next page that gives you a good overview of all the available options. After that follows a step-by-step instruction on how to design the programs that satisfy your requirements.

Each step begins with a description of the programs, options or settings that you can choose. Followed by a numbered sequence describing what to do to make the alterations that you require.

The buttons that you will need to use when compiling your own programs are , ,  - and .

Step forward in the menu by pressing the  button to the menu heading where you wish to make an alteration. The menu headings are: Programs, Temperature, Spin speed, Delayed start and Options. The options consist of sub-headings Pre-soaking, Quick main wash, E2: Eco/Efficiency, Super rinse, Short spin, Spin and Drain.

Using the   buttons, step forward or backward in the respective headings to the setting you wish to choose.

When you are at the desired setting, acknowledge your choice by pressing the  button once.

In order to remember what you have included in your washing programs, we recommend that

PROGRAM BUTTON	PROGRAM	TEMPERATURE (°C)				SPIN SPEED (RPM)				DELAYED START (h)				OPTIONS							
		P1	P2	P3	P4	1400	1400	800	800	0	0	0	0	Pre-sock	Quick main wash	E2: Eco/Efficiency	Super rinse	Short spin	Spin	Drain	
	NORMAL WASH					60	40	40	30	1400	1400	800	800	0	0	0	0	OFF	OFF	OFF	OFF
	NORMAL WASH					60	40	40	30	1400	1400	800	800	0	0	0	0	OFF	OFF	OFF	OFF
	SUPER QUICK WASH					60	40	40	30	1400	1400	800	800	0	0	0	0	OFF	OFF	ON	ON
	WOOL/HAND WASH					60	40	40	30	1400	1400	800	800	0	0	0	0	OFF	OFF	ON	ON

Settings of the four pre-set programs.



USE THE , , ,  BUTTONS TO MAKE YOUR OWN PROGRAMS.

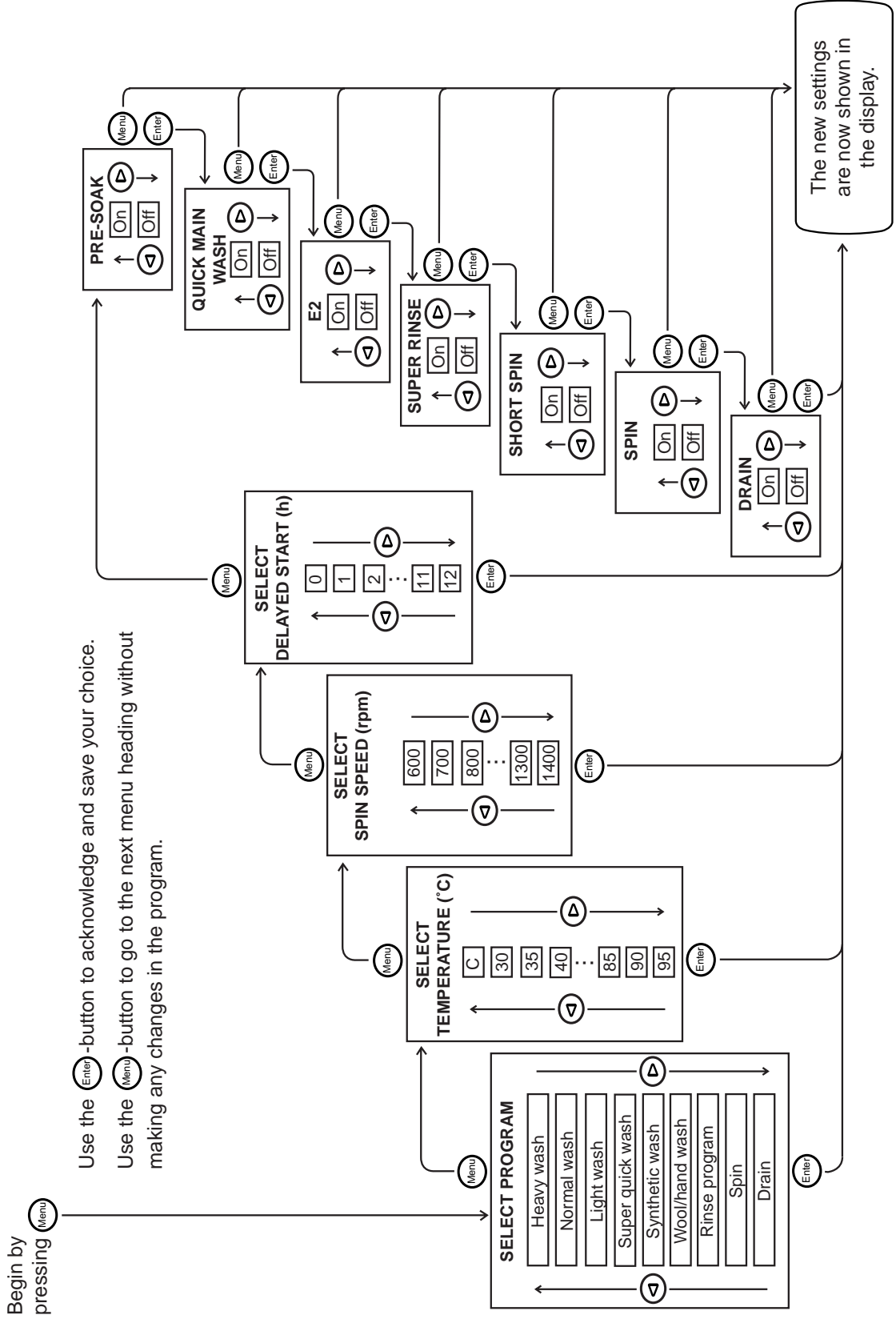

you fill in the settings that you have chosen in the table noted on the last page of this chapter.

1 - SELECT INITIAL PROGRAM

Begin by choosing one of the pre-set programs.

1. Press the button of the program you wish to alter, ie **P1**, **P2**, **P3** or **P4**.
2. Proceed to step 2.

2 - PROGRAMS

The programs that you can choose from have the following sequence:

Heavy wash: Pre-wash - main wash - 3 rinses - short spin after the main wash and the first two rinses - long spin after the final rinse.

Normal wash: Main wash - 3 rinses - short spin after the main wash and the first two rinses and a long spin after the final rinse.

Light wash: Short main wash - 3 rinses - short spin after the main wash and the first two rinses and a long spin after the final rinse.

Super Quick wash: Short main wash - 2 rinses - short spin.

Synthetic wash: Main wash - 3 rinses - short spin.

Wool/hand wash: Main wash (gentle action, high level of water) - 3 rinses - short spin.

Rinse program: 1 rinse - long spin.

Spin: 1 long spin.

Drain: Pumping out only.

1. Press the **Menu** button once.
2. Using the **◀** **▶** buttons, choose between Heavy wash, Normal wash, Light wash, Super Quick wash, Synthetic wash, Wool/hand wash, Rinse program, Spin or Drain.

3. Press the **Enter** button once to acknowledge and save your choice.

3 - TEMPERATURE

You can select a washing temperature C (cold), or between 30°C and 95°C. If you choose C the temperature will be the same as that of the incoming water.

For the Wool/hand wash program it is not possible to choose higher than 40°C.

1. Press the **Menu** button once.
2. With the **◀** **▶** buttons, step to the desired temperature.
3. Press the **Enter** button once to acknowledge and save your choice.

4 - SPIN SPEED

You can select spin speeds between 600 and 14•00 r/min.

For the programs Synthetic wash and Wool/hand wash the maximum speed is 800 r/min.

1. Press the **Menu** button once.
2. With the **◀** **▶** buttons, choose the desired spin speed.
3. Press the **Enter** button once to acknowledge and save your choice.

5 - DELAYED START





You can delay start your washing program by up to 12 hours.

If you select Delayed start at say five hours, the machine will start five hours after you press the start button.

When stepping to the desired time it will



shown at the bottom right corner of the display together with the -symbol.

1. Press the  button once.
2. With the   buttons, choose how long you wish to delay starting of the washing program.
3. Press the  button once to acknowledge and save your choice.





6 - OPTIONS

This heading has seven sub-headings (option headings) indicating the options that you can add to your program.

The seven options are: Pre-soak, Quick main wash, E2: Eco/Efficiency, Super rinse, Short spin, Spin and Drain.

Pre-soak



This option is useful if you have severely soiled washing that needs to soak before being washed. The washing will soak for two hours before the washing program starts.

1. Press the  button once.
2. Using the   buttons, select Pre-soak ON or OFF.
3. Press the  button once to acknowledge and save your choice. You will now come automatically to sub-heading:

Quick main wash

Using this option reduces the main wash by about 27 minutes. Use this option if your washing is only slightly soiled.

Can only be selected for the programs Heavy wash and Normal wash.

1. Using the   buttons, select Quick main wash ON or OFF.
2. Press the  button once to acknowledge and save your choice. You will now come automatically to sub-heading:



E2: Eco/Efficiency

If you choose this option the main wash will be prolonged by about 22 minutes. You can choose either an energy saving variant (I) without jeopardizing good washing results, or the variant (II) that gives an excellently effective program.

I. You can improve the washing effect by choosing E2: Eco/Efficiency ON. This will give you an energy saving program without jeopardizing the washing results.

II. Choose E2: Eco/Efficiency ON and a higher temperature. This will give you an even more effective washing program.

Can only be selected for the programs Heavy wash, Normal wash and Light wash.

1. Using the   buttons, select E2: Eco/Efficiency ON or OFF.
2. Press the  button once to acknowledge and save your choice. You will now come automatically to sub-heading:

Super rinse

Adds extra rinses to your washing program. To the programs Heavy wash, Normal wash and Light wash four extra rinses are added. To the others, two rinses are added. Choose Super rinse ON if at any time you want especially thorough rinsing. Use this function also when dye-

ing any material.

1. Using the ◀ ▶ buttons, select Super rinse ON or OFF.
2. Press the  button once to acknowledge and save your choice. You will now come automatically to sub-heading:

Short spin

Gives a shorter spin dry. Choose Short spin ON for washing that may be sensitive to rough treatment.

Short spin is always ON in the programs Synthetic wash and Wool/hand wash.

1. Using the ◀ ▶ buttons, select Short spin ON or OFF.
2. Press the  button once to acknowledge and save your choice. You will now come automatically to sub-heading:

Spin

You can exclude spin drying altogether. Choose Spin OFF and there will be no spin drying in the washing program.

1. Using the ◀ ▶ buttons, select Spin ON or OFF.
2. Press the  button once to acknowledge and save your choice. You will now come automatically to sub-heading:

Drain

Chosen in combination with spin OFF. The washing program will end with the final rinse water remaining in the machine.

This is a suitable choice if you have sensitive washing in the machine and you are unable to

take it out promptly at the end of the program. The washing will remain floating in the rinse water and thus counteract unnecessary creasing.

To empty the machine you can run the Drain program, or press the  button. If you then wish to spin dry the washing you can run the Spin program.

1. Using the ◀ ▶ buttons, select Drain ON or OFF.
 2. Press the  button once to acknowledge and save your choice.
- You have now gone through all the options.



You have now compiled and saved your own washing program.

The next time you wish to run this particular program all you have to do is press the program button that you chose initially as the basis for your settings.

SHORT CUTS

If you do not wish to make changes in all of the menu headings for your program you can simply jump past them.

To go to the next heading without making any changes, just press the  button once. The basic settings under this heading will thus remain unchanged.

NOTE

This applies to menu headings. If you are in any of the option headings and press the  button you will go to the next menu heading.





RESTORING PRE-SET WASHING PROGRAMS

You can always restore the four pre-set washing programs.

Proceed as follows:

1. Press the button of the program that you wish to restore and hold it pressed down.
2. Press the -button, without letting go of the program button.
3. Let go of both buttons and the pre-set program will now be restored.

12 CARE AND CLEANING

CHECKING THE NEEDLE TRAP AND THE DRAIN PUMP

The washing machine has a trap in which coins, hairpins and similar items fasten. Clean the needle trap and the drain pump as follows:

1. Ensure that the main power switch is turned OFF.

2. Using the partition piece for liquid detergent, open the drain pump cover as illustrated.

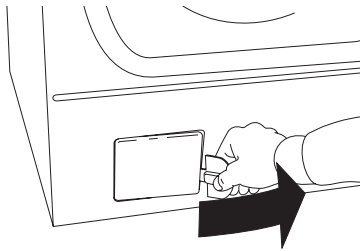

3. Drain off the water, eg, in a bowl, by pulling loose the drain hose on the inside of the cover.

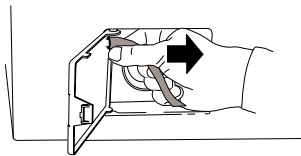

4. Open the pump by screwing its cover anticlockwise. Lift off the cover and needle trap.

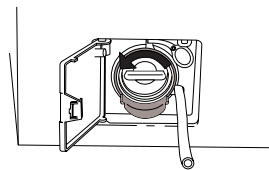

5. Clean out any objects and foreign matter from the pump housing. Ensure that the pump blade, at the rear, can be rotated.

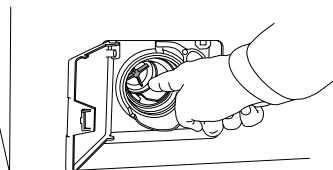

6. Screw on the cover and needle trap, put the drain hose back on the cover lug and close the cover.

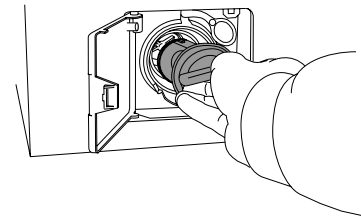

CLEANING THE DETERGENT COMPARTMENT

Pull out the detergent compartment as far as it goes.

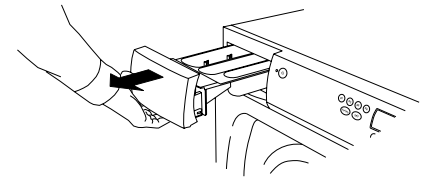

Then pull upwards and outwards as illustrated.

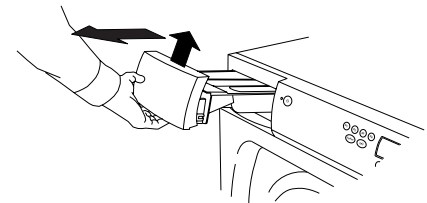

Flush and brush the detergent compartment to remove any residues.

Put the detergent compartment back in.

NOTE

Do not wash the detergent compartment in a dishwasher.

CLEANING THE OUTSIDE OF THE MACHINE

Use a mild detergent to clean the outside of the machine. Do not use any solvents, they can damage the machine.

NOTE

Do not spray the machine with water.

CLEANING HOLES UNDER THE RIDGES

If you suspect that objects, eg, nails, paperclips, pins and so on, have fallen through the washing drum you should check the space underneath the ridges. Such items can corrode and cause rust stains on your washing. Nails and other sharp objects can tear fabrics.

Proceed as follows:

1. Use a screwdriver or similar tool.

2. Insert the screwdriver in the middle hole in the ridge and carefully push the screwdriver handle to the left.

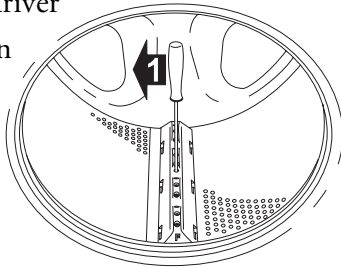

3. Grip the ridge with your other hand and lift it towards you as illustrated.

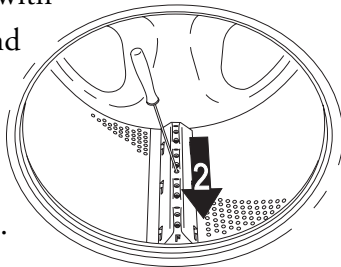

4. Lift up the ridge.

5. Remove any objects.

6. Position the ridge in the fixing hole with the F marking towards you. Ensure that the ridge lugs fit firmly in their holes in the drum. Slide the ridge away from you until it stops.

HARD WATER

If you live in an area that has hard water, the washer drum may become coated with a grey-white deposit. To get rid of the deposit, pour a packet of citric acid, about 20 gram, in the drum and run the Normal wash program at 95°C. You will find citric acid on the spice shelf in your grocer's store.

13 TROUBLE SHOOTING

DOOR WILL NOT OPEN

1. Check that the main switch is ON.
2. Is the power supply cut off? Check the fuses. The door cannot be opened using the  - button if the power supply is broken.
3. If the door cannot be opened in the normal manner, proceed as follows to make an emergency opening:

- Make certain that there is no water in the machine. If there is water left in the machine and you can not run the programme Drain, drain off the water, eg, in a bowl, by pulling loose the drain hose on the inside of the cover as illustrated in chapter 12, Care and cleaning.

- Make certain that the main power switch is OFF.

- Open the drain pump cover, down to the left. Use the partition piece for liquid detergent, as illustrated.

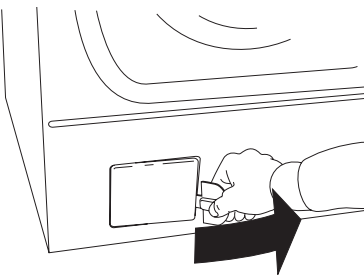

- Unscrew the screw holding the red plastic handle in place.

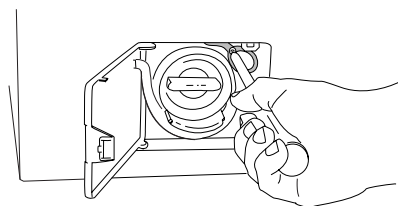

- Pull the handle and the door will open.

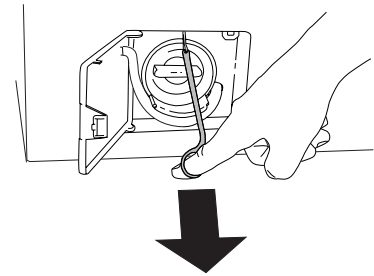

- Put the handle into its slot and screw it into place. Close the drain pump cover.

If the door still cannot be opened in the normal way after this, phone for service.

MACHINE WILL NOT START

1. Is the door properly closed? Press it shut firmly. The display flashes  down on the right if the door is not closed.
2. Is power cut off? Check the fuses.
3. Make certain that Delayed start is not activated.

FAULT INDICATIONS

Error messages appear in the display text field if faults occur while a program is in progress. To exit the error messages, switch the machine off or change the program.

The error messages that can be displayed are:

Door lock fault. Phone Service.

Foaming. Run the Rinse program once. Check dosing of detergent. Use low-lather detergent.

Over flow. Phone Service.

Pressure sensor fault. Phone Service.

Temperature stop fault. Faulty temperature stop, phone Service.

Thermistor fault. Faulty thermistor, phone Service.

Water inlet fault. Fault in the supply of water, ensure:

- that the water tap is open.
 - that the strainer in the water inlet connection is not clogged.
1. Turn off the water tap.
 2. Disconnect the hose.
 3. Clean the strainer in the water inlet of the machine.
 4. Re-connect the hose.
 5. Open the water tap.
 6. Run the program again to check that the fault is remedied.

Water outlet fault. Faulty pumping, check the drain hose and the drain pump.

1. Straighten out any kinks in the drain hose.
2. Is there anything stuck in the drain hose outlet? Clear the hose.
3. Is the drain pump blocked by foreign objects? Clear the pump, see Chapter 12, Care and cleaning.

Wash motor fault. Phone Service.

0000 flashes at the top right of the display. The machine has failed to spin.

1. The machine incorporates an out-of-balance detector, which reduces spin speed or prevents spinning from starting if the load is very unbalanced. Turn the main switch,  off and turn it on again. Open the door and redistribute the washing.
2. After correcting, run the program Spin.



If  flashes at the lower right corner of the display it is an indication that you have attempted to start a program with the door open. Close the door and try again.



WRONG LANGUAGE ON THE DISPLAY

If the language on the display becomes altered for any reason, it can be restored to the initial language again.

The available languages are Dansk, Deutsch, English, Español, Français, Italiano, Nederlands, Norsk, Português, Suomi and Svenska.



Proceed as follows to change the language:



Turn the main switch,  off and turn it on again. Press the  button five times, then press the  button five times. These ten times must be completed within fifteen seconds.

Within three seconds after pressing  the last time, step to the desired language using the   buttons.

TEMPERATURE - CELSIUS OR FARENHEIT

If you want to change the temperature indication from Celsius (C) to Farenheit (F), proceed as follows:

Turn the main switch,  off and turn it on again. Press the  button five times, then press the  button five times. These ten times must be completed within fifteen seconds.

Within three seconds after pressing  the last time, use the   buttons to select temperature indication.

14 TECHNICAL INFORMATION

TECHNICAL DATA

Height:	850 mm
Width:	595 mm
Depth:	585 mm
Weight:	73 kg
Drum volume:	50 litre
Washing capacity:	5.5 kg
Spin speed:	600 - 1400 r/min
Rated power, connection:	See data plate
Rated power, element:	See data plate
Water pressure:	0.1 - 1 MPa 1 - 10 kp/cm ² 10 - 100 N/cm ²
Material: Washing drum and water container	Stainless steel.
Material: Outer cover	Hot-galvanized, powder lacquered steel or stainless steel.
Positioning:	Stationary on four adjustable, rubber coated feet.
Water connection:	1.5 m PEX pipe.
Drain:	1.7 m polypropylene hose.

STANDARD TESTS

Australia:	AU/NZS 2040.1:1998.
Washing program:	P2 Normal wash, 40°C, 5.5 kg mixed cotton, 1400 rpm.
Connection:	Cold water supply.
Procedure for acoustic measurement:	IEC 60 704-2-4.

15 SERVICE AND GUARANTEE

SERVICE

Before calling for service, check to see whether the fault is due to something that you can put right yourself. See chapter 13, Trouble shooting.



If you do require service, telephone your local ASKO retailer or the ASKO representative for your country. See guarantee card for address and telephone number.

GUARANTEE

For guarantee details, see the guarantee card.

16 QUICK GUIDE

1. Sort the washing.





2. Press the main power switch, , and open the washer door, .

3. Load the washing.



4. Fill with detergent and conditioner as required.

Detergent (main wash) to the left (**2**), detergent if required (pre-wash) in the middle section (**1**) and conditioner to the right (). If liquid detergent is used the partition piece, attached underneath the detergent compartment, is to be inserted in the inner slot in the compartment.

5. Select a program.

The machine has four pre-set washing programs, , ,  and . Press the button for

the desired program.

You can make temporary alterations in the programs and they will remain in the memory while the program is running. Alter Temperature with the  button and Spin speed with the  button. The current setting of the respective function increases to the next available temperature or speed each time you press the relevant button.

6. Close the door and press the  button.

7. Washing program completed.

Press the  button and take out the washing.

8. When washing is completed.

Turn off the main switch, , and close the washer door.

WASHING →	Cotton, linen, white and light coloured garments.			
	Cotton, linen. Darker coloured garments.		Washing that needs a quick freshener, eg shirts and tracksuits	
	Garments marked IWS, Superperwash or Hand wash.			
SET THE:				
Program	1 or 2 Normal wash	1 or 2 Normal wash	3 Super Quick wash	4 Wool/hand wash
Temperature (°C)	60-95	40-60	30-40	30-40
Spin Speed	600-1400	600-1400	600-1400	600-800
Amount of washing	1/1	1/1	1/2	1/3

17 INDEX

	Chapter		Chapter		Chapter
Acetate	8	H and wash	8,9,11,16	Rinse program	11
Acrylate	8	Hardness of water	1,12	S afety instructions	2
Allergy	8	Heavy wash	11	Selecting program	9,11,16
Altering settings after starting	9	Height	10	Short spin	8,11
Amount of washing	8,9,16	I nstallation, see Instructions for		Silk	8
B asic settings	9	installation		Sorting the washing	8
Bleach	8	Interrupting a program	2	Spin	9,11,16
Burling	8	L anguage	12	Spin speed	9,11,16
C are	12	LC Display	8	Start	9
Children's safety	3	Light wash	8,11	Stop	2,9
Child safety start	3	Linen	8,16	Strainer	12
Cleaning	12	Liquid detergent	9	Super Quick wash	9,11,16
Cleaning hole	12	M ain power switch	4,6,9,16	Super rinse	11
Colours	8,16	Making own programs	11	Synthetic fibre	8
Conditioner	5,9	Material	8	Synthetic wash	8
Consumption values	10	N eedle trap	12	T echnical information	10
Cotton	8,16	Normal wash	8,9,11,16	Temperature	9,11,13,16
Cover, drain pump	4,12,13	Nylon	8	Temperature indication	13
Crease free, see No pumping out		O ptions	11	Temporary alterations	9,16
D ata plate	4,10	Overfill protection	2,13	Textile dyeing	8
Delayed start	9,11,16	Own washing programs	11	Time, see Remaining washing	
Delicate garments	8,16	P acking material	2	time	
Delicate washing	8	Panel	6	Towelling	8
Depth	10	Partition piece	5,9	Transport support	1
Detergent ball	9	Parts of the washing machine	4	Transport	2
Detergent	8,9	Pockets	8	Trouble shooting	13
Detergent bag	9	Polyester	8	U nbalance	13
Detergent compartment	9,12	Powder detergent	9	V iscose	8
Display, see LC Display		Pre-set washing programs	9	W asher door	2,4
Disposal	2	Pre-soak	11	Washing	9,16
Door opening, see Washer door		Pre-wash	11	Washing capacity	9,10
Door, see Washer door		Pre-wash detergent	9	Washing ridge	12
Dosage	8	Program position	9	Weight	10
Drain	11	Programs	11	White washing	8,16
Drain hose	12,13	Q uick guide	16	Width	10
Drain pump	12,13	Quick main wash	11	Winter storage	2
Dyeing, see Textile dyeing		R ayon	8	Wool washing	8,9,16
E 2:Eco/Efficiency	8,11	Recommended washing mark-		Z ip fastener	8
Emergency stop, see Interrupting		ing	8		
a program		Remaining washing time	8,9		
Energy consumption	10	Restoring pre-set program	11		
F ault indications	13				
Fuses	13				

