

This Owner's Manual is provided and hosted by [Appliance Factory Parts](http://www.appliancefactoryparts.com).



Monessen Hearth C2804VFP Owner's Manual

[Shop genuine replacement parts for Monessen Hearth
C2804VFP](#)



[Find Your Monessen Hearth Fireplace Parts - Select From 701 Models](#)

----- Manual continues below part list -----

Available Replacement Parts for Monessen Hearth C2804VFP

SRV00K0632	ASSY-WIRE
SRV32D0232	SWITCH, ON/OFF+
SRV14D0468	VALVE MV LP (060620)+

UNVENTED GAS CAST IRON STOVE

INSTALLATION AND OPERATING INSTRUCTIONS

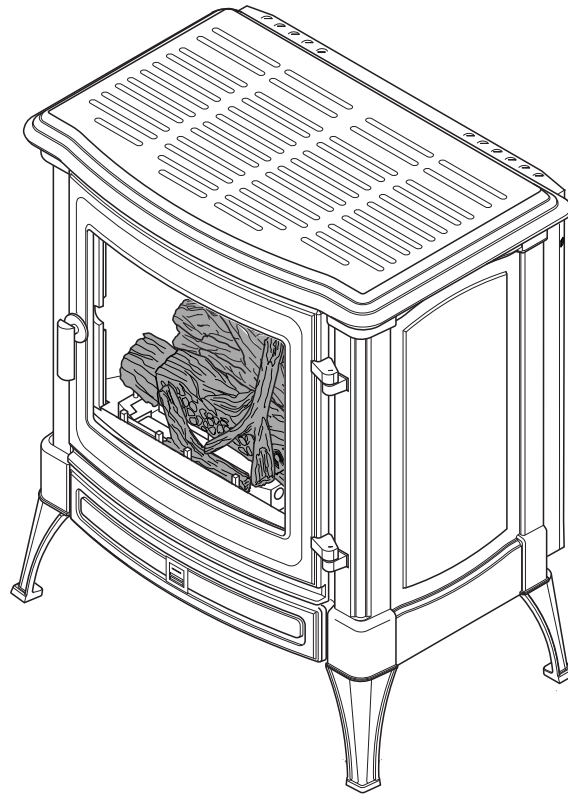

MODELS:

C2801VF, C2802VF,
C2803VF, and C2804VF

Natural Gas or
Propane/LPG
Milli-Volt Control



This appliance may be installed in an aftermarket, permanently located, manufactured (mobile) home, where not prohibited by local codes.

This appliance is only for use with the type of gas indicated on the rating plate. This appliance is not convertible for use with other gases.

This is an unvented gas-fired heater. It uses air (oxygen) from the room in which it is installed. Provisions for adequate combustion and ventilation air must be provided. Refer to page 8.

WARNINGS

If the information in this manual is not followed exactly, a fire or explosion may result causing property damage, personal injury or loss of life.

- Do not store or use gasoline or other flammable vapors and liquids in the vicinity of this or any other appliance.
- **WHAT TO DO IF YOU SMELL GAS**
 - Do not try to light any appliance.
 - Do not touch any electrical switch; do not use any phone in your building.
 - Immediately call your gas supplier from a neighbor's phone. Follow the gas supplier's instructions.
 - If you cannot reach your gas supplier, call the fire department.
- Installation and service must be performed by a qualified installer, service agency or the gas supplier.

READ AND SAVE THESE INSTRUCTIONS

CONTENTS

Important Safety Information	3	Log Placement	16
Product Features	5	Installing Logs on Grate.....	16
Getting Started	6	Placing the Decorative Rock.....	16
Product Specifications	7	Flame Appearance	17
Ignition Controls	7	Checking Pilot Flame	17
Pilot.....	7	Checking the Burner Flame	17
Thermal Generator	7	Operating Instructions	18
General Installation Information	8	For Your Safety Read Before Lighting	18
Codes	8	Milli-Volt Control Lighting Instructions.....	19
Adequate Combustion and Ventilation Air.....	8	To Turn Off Gas to Heater.....	19
Clearances / Height Requirements	10	Match Lighting Instructions	20
Connecting the Gas.....	11	Cleaning and Servicing	20
Checking Gas Pressure	12	Replacement Parts List	21
Connecting Remote Receiver	12	Logs	21
Electrical Wiring.....	13	Burner Assembly.....	22
Connecting Optional Wall Switch or		Troubleshooting.....	24
Thermostat.....	13	Warranty	Back Cover
Checking System Operation	13		
Installing Thermostat Sensor	14		

IMPORTANT SAFETY INFORMATION

INSTALLER

Please leave these instructions with the owner.

OWNER

Please retain these instructions for future reference.

IMPORTANT

Read these instructions carefully before installing or trying to operate this vent-free gas heater.

WARNING

- **Any change to this heater or its controls can be dangerous.**
- **Improper installation or use of the heater can cause serious injury or death from fire, burns, explosion or carbon monoxide poisoning.**
- **Do not allow fans to blow directly into the stove. Avoid any drafts that alter burner flame patterns.**
- **Do not use a blower insert, heat exchanger insert or other accessory, not approved for use with this heater where applicable.**

1. Due to high temperatures, the appliance should be located out of traffic and away from furniture and draperies.
2. Children and adults should be alerted to the hazard of high surface temperature and should stay away to avoid burns or clothing ignition.
3. Young children should be carefully supervised when they are in the same room with the appliance.
4. Do not place clothing or other flammable material on or near the appliance.
5. Any safety screen or guard removed for servicing an appliance, must be replaced prior to operating the heater.
6. Installation and repair should be done by a qualified service person.
7. To prevent malfunction and/or sooting, an unvented gas heater should be cleaned before use and at least annually by a professional service person. More frequent cleaning may be required due to excessive lint from carpeting, bedding material, etc. It is imperative that control compartments, burners and circulating air passageways be kept clean.

9. The installation must conform with local codes or, in the absence of local codes, with the **National Fuel Gas Code, ANSI Z223.1/NFPA54**.
10. This unit complies with ANSI Z21.11.2-2001 Unvented Heaters.
11. Do not install heater in a bathroom or bedroom.
12. Correct installation of the ceramic fiber logs, proper location of the heater, and annual cleaning are necessary to avoid potential problems with sooting. Sooting, resulting from improper installation or operation, can settle on surfaces outside the fireplace. See log placement instructions for proper installation.
13. Avoid any drafts that alter burner flame patterns. Do not allow fans to blow directly into fireplace. Do not place a blower inside burn area of firebox. Ceiling fans may create drafts that alter burner flame patterns. Sooting and improper burning will occur.
14. **Caution:** Candles, incense, oil lamps, etc. produce combustion byproducts including soot. Vent-free appliances will not filter or clean soot produced by these types of products. In addition, the smoke and/or aromatics (scents) may be reburnt in the vent-free appliance which can produce odors. It is recommended to minimize the use of candles, incense, etc. while the vent-free appliance is in operation.

8. **CARBON MONOXIDE POISONING:** Early signs of carbon monoxide poisoning are similar to the flu with headaches, dizziness and/or nausea. If you have these signs, obtain fresh air immediately. Have the heater serviced as it may not be operating properly.

Continued on page 4

IMPORTANT SAFETY INFORMATION

Continued from page 3

15. This is an unvented gas-fired heater. It uses air (oxygen) from the room in which it is installed. Provisions for adequate combustion and ventilation air must be provided. See page 8.
16. Keep room area clear and free from combustible materials, gasoline and other flammable vapors and liquids.
17. Unvented gas heaters are a supplemental zone heater. They are not intended to be a primary heating appliance.
18. Unvented gas heaters emit moisture into the living area. In most homes of average construction, this does not pose a problem. In houses of extremely tight construction, addition mechanical ventilation is recommended.
19. During manufacturing, fabricating and shipping, various components of this appliance are treated with certain oils, films or bonding agents. These chemicals are not harmful but may produce annoying smoke and smells as they are burned off during the initial operation of the appliance; possibly causing headaches or eye or lung irritation. This is a normal and temporary occurrence.

The initial break-in operation should last two to three hours with the burner at the highest setting. Provide maximum ventilation by opening windows or doors to allow odors to dissipate. Any odors remaining after this initial break-in period will be slight and will disappear with continued use.
20. Input ratings are shown in BTU per hour and are for elevations up to 2,000 feet. For elevations above 2,000 feet, input ratings should be reduced 4 percent for each 1,000 feet above sea level. Refer to the National Fuel Gas Code.
21. The appliance and its appliance main gas valve must be disconnected from the gas supply piping system during any pressure testing of that system at test pressures in excess of 1/2 psig (3.5 kPa).
22. The appliance must be isolated from the gas supply piping system by closing its equipment shutoff valve during any pressure testing of the gas supply piping system at test pressures equal to or less than 1/2 psig (3.5 kPa).
23. Do not use this room heater if any part has been under water. Immediately call a qualified service technician to inspect the room heater and to replace any part of the control system and any gas control which has been under water.
24. Never burn solid fuels in an unvented room heater, fireplace or stove.
25. Do not set kettles or humidifying devices on top of stove.
26. The stove door/screen must be closed when the appliance is operating. The screen shall have openings for induction of combustion air.

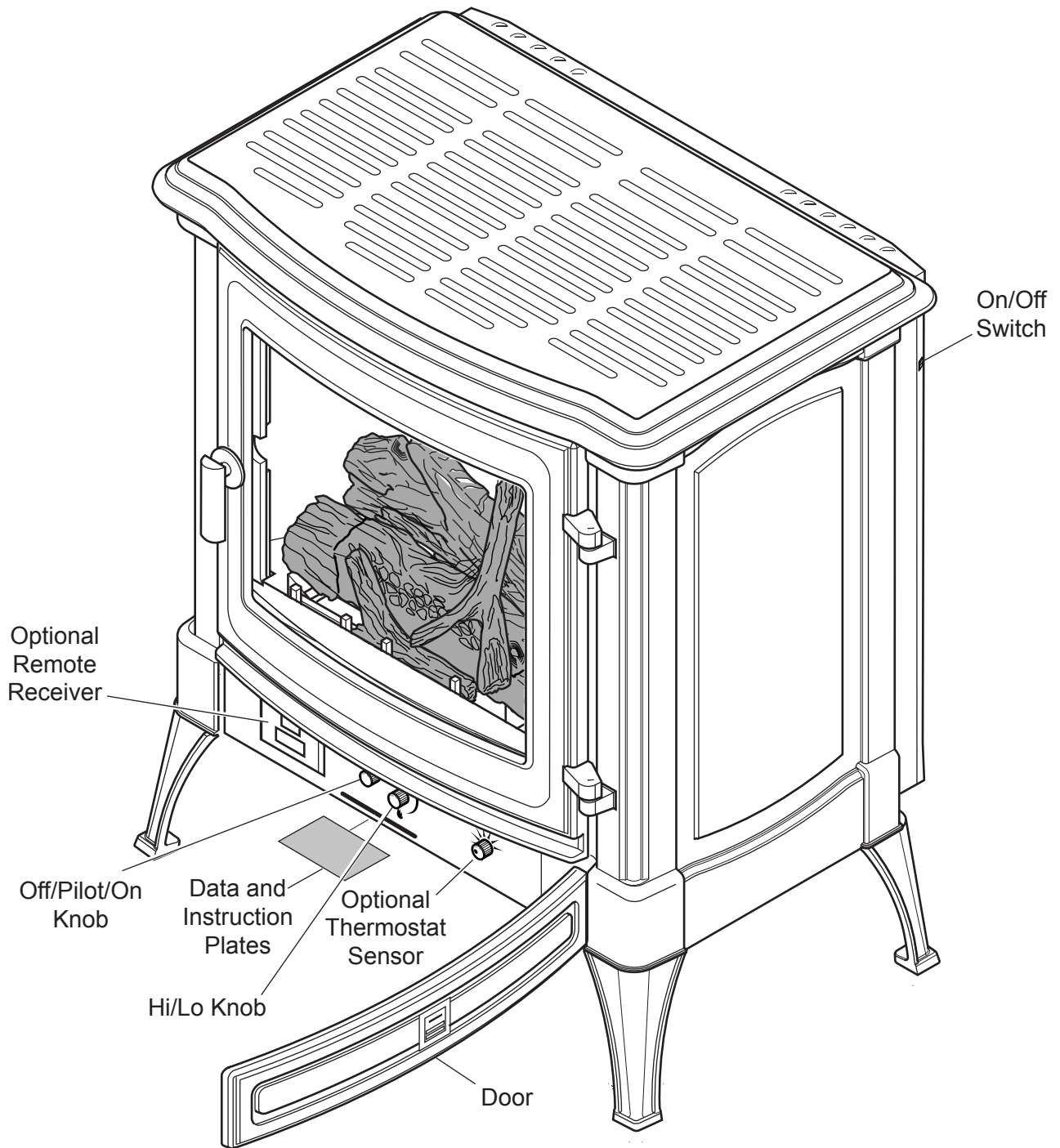

Figure 1 - Cast Iron Stove

GETTING STARTED

MAKE SURE YOU HAVE RECEIVED ALL PARTS:

Check your packing list to verify that all listed parts have been received. You should have the following:

- Cast Iron Stove with Burner Assembly
- Installation/Operating Instructions
- Ceramic fiber logs
- Four (4) Leg Levelers
- Touch-up Paint

Millivolt controlled heater designed to be operated with optional devices for ON/OFF functions.

- Hand-Held Remote with Receiver, Manual or Thermostat
- Wall Switch with 15' Wire
- Wall T-stat with 15' Wire
- Stove Mounted Thermostat Control

CAUTION

Handle the gas log burner assembly by the grate only. Do not pick the unit up by the burners.

Gloves are recommended when handling ceramic fiber logs to prevent skin irritation from loose fibers. Logs are fragile--handle with care.

Carefully inspect the contents for shipping damage. If any parts are missing or damaged, immediately inform the dealer from whom you purchased the appliance. **Do not attempt to install any part of the appliance unless you have all parts in good condition.**

WHAT YOU WILL NEED FOR INSTALLATION:

You must have the following items available before proceeding with installation:

- External regulator (for propane/L.P.G.) or high pressure natural gas (1 to 2 PSI system)
- Piping which complies with local codes
- Pipe sealant approved for use with propane/L.P.G. (Resistant to sulfur compounds)
- Manual shutoff valve
- Sediment trap (recommended)
- Tee joint
- Pipe wrench or appropriate wrench set
- Screwdrivers

NATURAL GAS

NOTE: An external regulator is required to reduce supply pressure to a maximum of 10¹/₂" w.c. on Natural Gas systems operating at higher pressure.

MILLIVOLT PRESSURE

Regulator Pressure Setting: 3.5" w.c.
Pilot Regulator: 3.5" w.c.
Gas Inlet Pressure: Max. 10 1/2" w. c. Min. 5" w.c.

Model Number	Type	Gas Rate	
		Max. BTU/Hr	Min. BTU/Hr
C2801/02/03/04VFN	Milli-Volt	28,000	18,000

PROPANE / LPG

Note: An external regulator is required to reduce supply pressure to a maximum of 13" w.c.

MILLIVOLT PRESSURE

Regulator Pressure Setting: 10" w.c.
Gas Inlet Pressure: Maximum 13" w.c.
Minimum 11" w.c.

Model Number	Type	Gas Rate	
		Max. BTU/Hr	Min. BTU/Hr
C2801/02/03/04VFP	Milli-Volt	28,000	20,000

IGNITION CONTROLS

Piezo ignitor allows ignition of the pilot without the use of matches.

Milli-Volt control has four (4) positions:

- OFF** - All gas to the burner is shut off at the valve.
- IGN** - Valve position to light/maintain a standing pilot.
- ON** - Valve position to turn burners ON/OFF with remote switch/thermostat.
- LOW/HI** - Variable position to control flame height (heat output). Both front and rear burners are in operation to provide realistic glow and yellow flame.

PILOT/ODS

The gas log heater is fitted with a specially designed safety pilot (ODS assembly) light which senses the amount of oxygen available in the room and shuts the gas log heater off if the oxygen level begins to drop below a satisfactory level. The pilot can only be relit when adequate fresh air is available.

THERMAL GENERATOR

The millivolt gas log pilot is fitted with a millivolt thermopile generator to provide power for remote activation.

GENERAL INSTALLATION INFORMATION

WARNING

Do not install the heater ...

- Where curtains, furniture, clothing, or other flammable objects are less than 42" from the front of the heater.
- In high traffic areas.
- In windy or drafty areas.

CODES

Adhere to all local codes or, in their absence, the latest edition of THE NATIONAL FUEL GAS CODE ANSI Z223.1 or NFPA54 which can be obtained from...

American National Standards Institute, Inc.

1430 Broadway
New York, NY 10018

or

National Fire Protection Association, Inc.

Batterymarch Park
Quincy, MA 02269

ADEQUATE COMBUSTION AND VENTILATION AIR

This heater shall not be installed in a confined space or unusually tight construction unless provisions are provided for adequate combustion and ventilation air.

The National Fuel Gas Code, (ANSI Z223.1/NFPA54), defines a confined space as a space whose volume is less than 50 cubic feet per 1,000 BTU per hour (4.8 m³ per kw) of the aggregate input rating of all appliances installed in that space and an unconfined space as a space whose volume is not less than 50 cubic feet per 1,000 BTU per hour (4.8 m³ per kw) of the aggregate input rating of all appliances installed in that space. Rooms communicating directly with the space in which the appliances are installed, through openings not furnished with doors, are considered a part of the unconfined space.

UNUSUALLY TIGHT CONSTRUCTION IS DEFINED AS CONSTRUCTION WHERE...

- a) walls and ceilings exposed to the outside atmosphere have a continuous water vapor retarder with a rating of 1 perm (6 x 10¹¹ kg per pa-sec-m²) or less with openings gasketed or sealed;
- b) weather striping has been added on openable windows and doors, and
- c) caulking or sealants are applied to areas such as joints around window and door frames, between sole plates and floors, between wall-ceiling joints, between wall panels, at penetrations for plumbing, electrical, and gas lines, and at other openings.

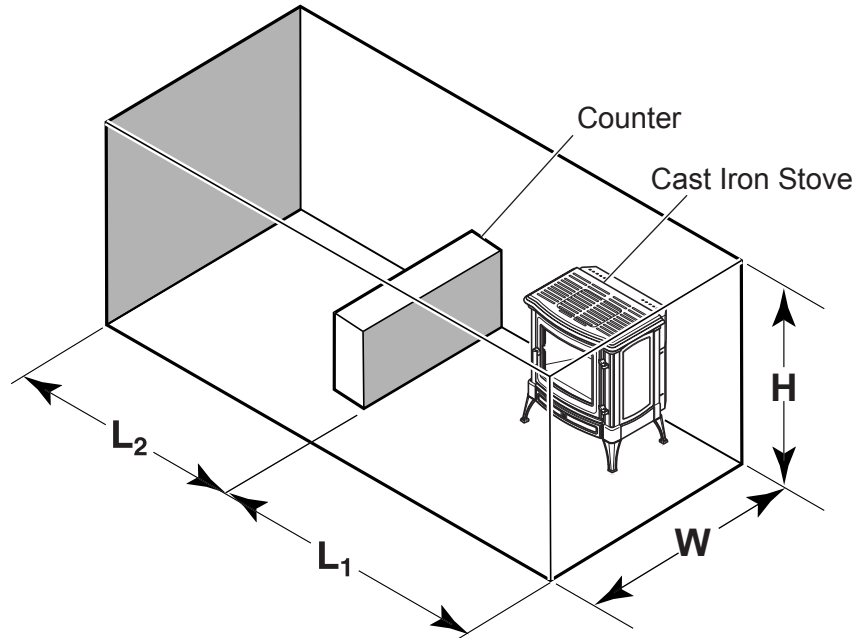

Figure 2 - Example of a Large Room with 1/2 Wall Divider

The following formula can be used to determine the maximum heater rating per the definition of unconfined space:

$$\text{BTU/Hr} = \frac{(L_1 + L_2) \text{ Ft} \times (W) \text{ Ft} \times (H) \text{ Ft}}{50} \times 1000$$

Consider two connecting rooms with an open area between, with the following dimensions:

$$L_1 = 15\frac{1}{2} \text{ Ft.}, L_2 = 12 \text{ Ft.}, W = 12 \text{ Ft.}, H = 8 \text{ Ft.}$$

$$\text{BTU/Hr} = \frac{(15\frac{1}{2} + 12) \times (12) \times (8)}{50} \times 1000 = 52800 \text{ BTU/Hr}$$

If there were a door between the two rooms the calculation would be based only on the room with the heater.

$$\text{BTU/Hr} = \frac{(15\frac{1}{2}) \times (12) \times (8)}{50} \times 1000 = 29760 \text{ BTU/Hr}$$

WARNING

If the area in which the heater may be operated is smaller than that defined as an unconfined space or if the building is of unusually tight construction, provide adequate combustion and ventilation air by one of the methods described in the National Fuel Gas Code, ANSI Z223.1, NFPA54, Section 5.3 or applicable local codes.

CLEARANCES / HEIGHT REQUIREMENTS

WARNING

The dimensions shown in *Figure 3* are minimum clearances to maintain in installing this heater. Left and right clearances are determined when facing the front of the heater. Follow these instructions carefully to ensure safe installation. Failure to follow instructions exactly can create a fire hazard.

The appliance cannot be installed on a carpet, tile or other combustible material other than wood flooring, the appliance shall be installed on a metal, wood or noncombustible material panel extending full width and depth of the appliance.

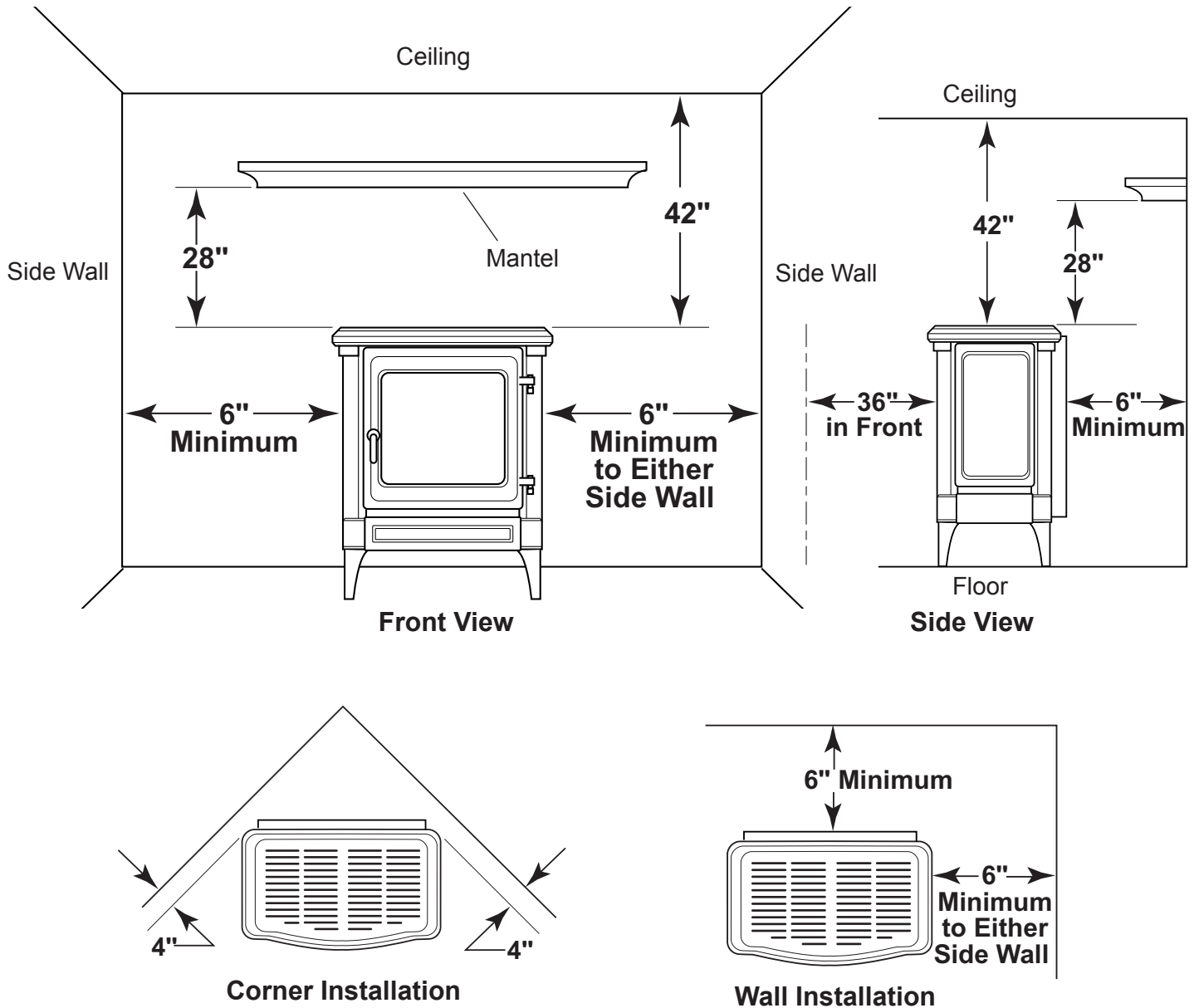

Figure 3 - Minimum Clearance to Walls and Ceiling

CONNECTING THE GAS

NOTICE: A qualified gas appliance installer must connect the heater to the gas supply. Consult all local codes.

CAUTION

Use new black iron or steel pipe. Internally tinned copper or copper tubing can be used per National Fuel Code, section 2.6.3, providing gas meets hydrogen sulfide limits, and where permitted by local codes. Gas piping system must be sized to provide minimum inlet pressure (Listed on Data Plate) at the maximum flow rate (BTU/Hr). Undue pressure loss will occur if the pipe is too small.

A manual shutoff valve must be installed upstream of the appliance. Union tee and plugged $\frac{1}{8}$ " NPT pressure tapping point should be installed upstream of the appliance. See *Figure 4*.

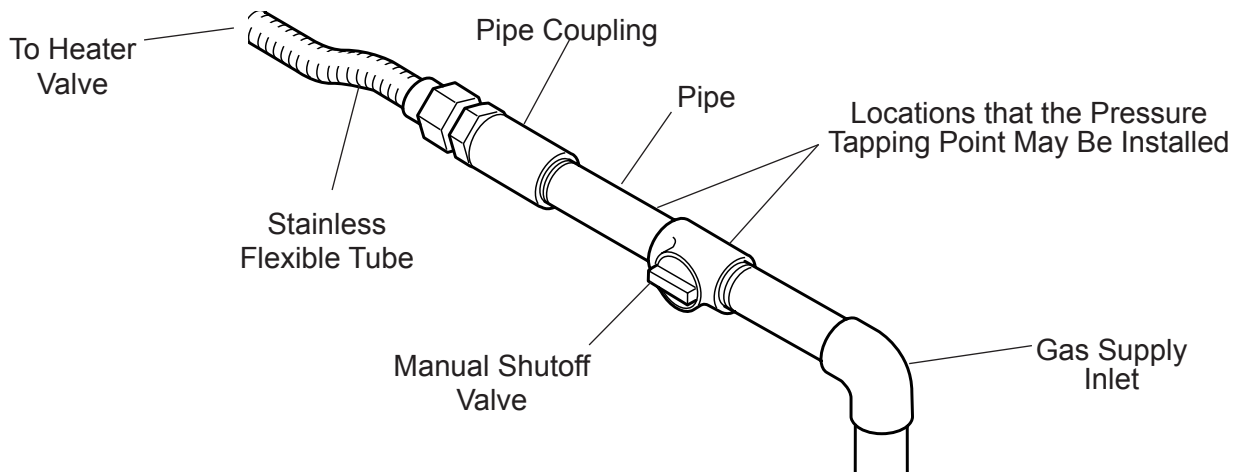

Figure 4 - Gas Connection

IMPORTANT: Hold heater valve firmly with a wrench to prevent movement when connecting to inlet pipe.

CAUTION

CHECK GAS TYPE: The gas supply must be the same as stated on the heater's rating plate. If the gas supply is different, **DO NOT INSTALL THE HEATER**. Contact your dealer for the correct model.

Always use an external regulator for all propane/LPG heaters and high pressure one to two-pound systems only, to reduce the supply tank pressure to a maximum of 13" w.c. This is in addition to the internal regulator in the heater valve.

CHECKING GAS PRESSURE AND CONNECTING REMOTE RECEIVER

WARNING

Connecting directly to an unregulated propane/L.P.G. tank can cause an explosion.

The heater gas inlet connection is 3/8" NPT at the valve. The inlet is located on left side of stove. Remove front control plate to better access the inlet.

When tightening up the joint to the valve, hold the valve securely with a wrench to prevent movement.

Test all gas joints from the gas meter to the heater valve for leaks using a gas analyzer or soap and water solution after completing connection. **DO NOT USE AN OPEN FLAME.**

Check the gas pressure with the appliance burning and the control set to **HIGH**.

MILLIVOLT CONTROL (FIGURE 5)

The valve regulator controls the burner pressure which should be checked at the pressure test point.

If outlet pressure is low, check inlet pressure against data plates or manual.

Turn captured slotted screw counter clockwise 2 or 3 turns and then place tubing to pressure gauge over test point (Use test point "OUT" closest to control knob). After taking pressure reading, be sure and turn captured screw clockwise firmly to re-seal. Do not over torque. Check for gas leaks.

NOTE: Remove control panel to access gas valve and ignitor battery module.

CONNECTING REMOTE RECEIVER

1. Remove cover on control panel to show opening for remote receiver. See Figure 6.
2. Cut cable to length (approximately 12") for placement in the fireplace.
3. Strip back 1/4" of the insulation from both ends of each wire.
4. Connect two .25 female connectors to the wires at one end of the cable.
5. Insert the opposite ends of the wires into the receiver wire terminals and tighten the screws.
6. Connect the connectors to the two .25" male connectors located on the left side when facing the unit (Figure 6). Do not let the wire touch the grate or burners.
7. Slide remote receiver in the opening of control panel. Use two screws provided to attach remote receiver to the control panel. See Figure 6.
8. Replace Cover. See Figure 6.

NOTE: Do not place remote in combustion chamber.

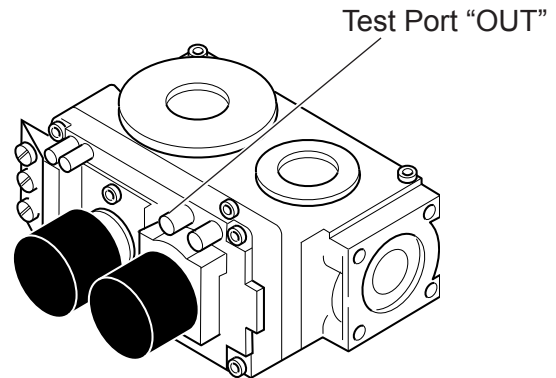

**Figure 5 - Pressure Test Point Location
Milli-Volt Control**

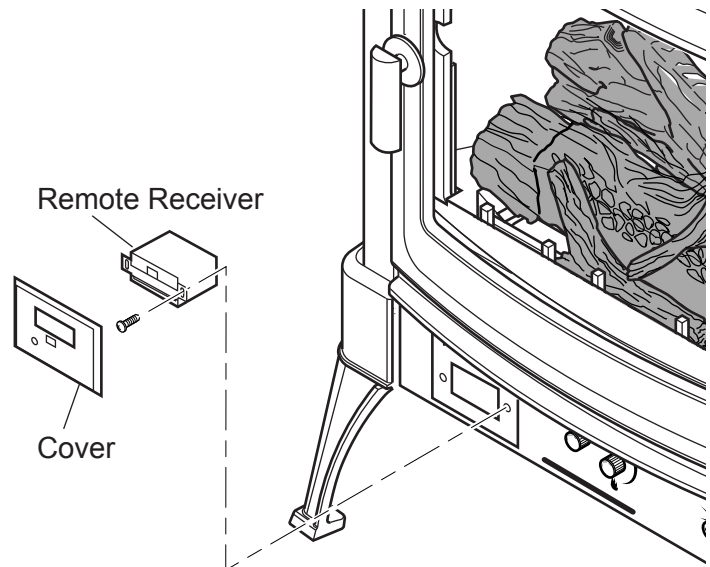

Figure 6 - Installing Remote Receiver

ELECTRICAL WIRING (MILLI-VOLT)

The milli-volt valve is a self-powered combination gas control **THAT DOES NOT REQUIRE 110 VAC TO OPERATE.**

CAUTION
Label all wires prior to disconnection when servicing controls. Wiring errors can cause improper and dangerous operation. Verify proper operation after servicing.

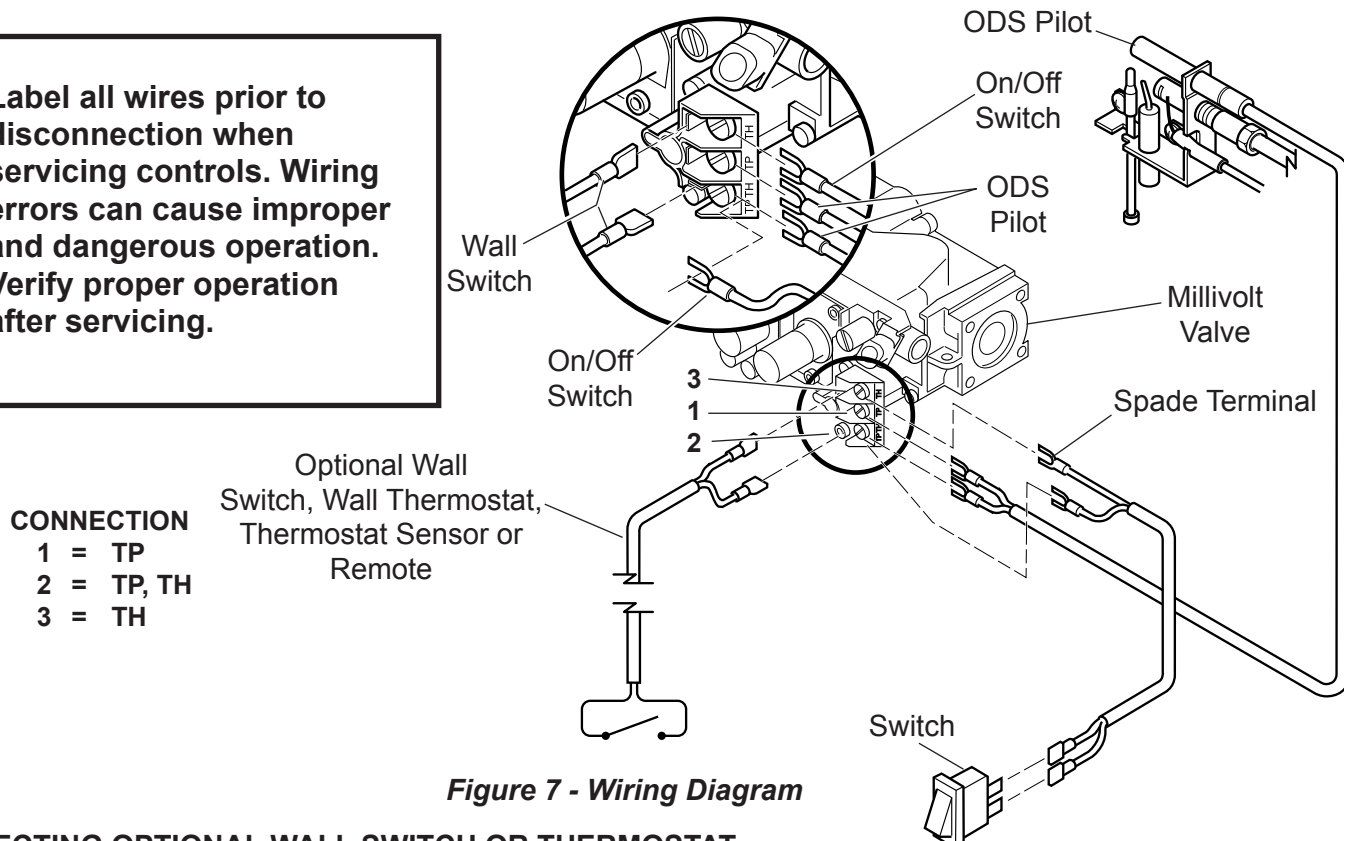

Figure 7 - Wiring Diagram

CONNECTING OPTIONAL WALL SWITCH OR THERMOSTAT

1. Use 18 awg, two-wire cable, 15 feet maximum length.
2. At one end of the cable, connect both wires to the wall switch or thermostat. At the other end, connect one wire to TP/TH and one wire to TH, or connect the wall switch/thermostat to the two male (0.25") terminals on the left side of the unit. The color of the wires does not matter.

CHECKING SYSTEM OPERATION

The millivolt system and individual components may be checked with a millivolt meter having a 0-1000mv range. Conduct each check shown in chart by connecting meter test leads to terminals as indicated.

CHECK TEST	TO TEST	CONNECT METER LEADS TO TERMINALS	THERMOSTAT CONTACTS	METER READING SHOULD BE
A	COMPLETE	2 & 3 SYSTEM	CLOSED	MINIMUM 175mv
B	THERMOPILE OUTPUT	1 & 2	OPEN	500mv OR MORE

A. COMPLETE MILLIVOLT SYSTEM CHECK

("A" Reading - Thermostat contacts CLOSED - Control Knob "ON" - Main Burners should turn ON)

- a. If the reading is more than 175 millivolts and the automatic valve still does not come on - replace the valve.
- b. If the closed circuit reading ("A" reading) is less than 175 millivolts, determine cause for low reading - proceed as follows:

B. THERMOPILE OUTPUT READING CHECK

("B" Reading - Thermostat contacts OPEN - Main burner OFF)

Check gas pressure to the unit. If gas pressure is within minimum and maximum on data plate, then replace pilot. 500 millivolts minimum. If the minimum millivolt reading is not obtainable, replace pilot.

ELECTRICAL WIRING (MILLI-VOLT)

INSTALLING THERMOSTAT SENSOR (OPTION SOLD SEPARATELY)

1. Remove the face plate by removing the six screws holding the faceplate in place. This will allow you to pull the faceplate away from the unit about 3" to 4". See *Figure 8*.
2. Slip the t-stat sensor behind the faceplate. Attach the t-stat sensor to the faceplate with 2 screws provided. Make sure the thermo bulb wire is on the bottom of the t-stat sensor. See *Figure 9*.
3. Attach wiring harnesses to back of t-stat sensor. See *Figure 8*. Attach the other ends of the harness to either TP/TH and TH on control valve or to existing wiring harness with two (2) 0.250" male spade terminals for remote t-stat operation. See *Figure 8*, page 13.

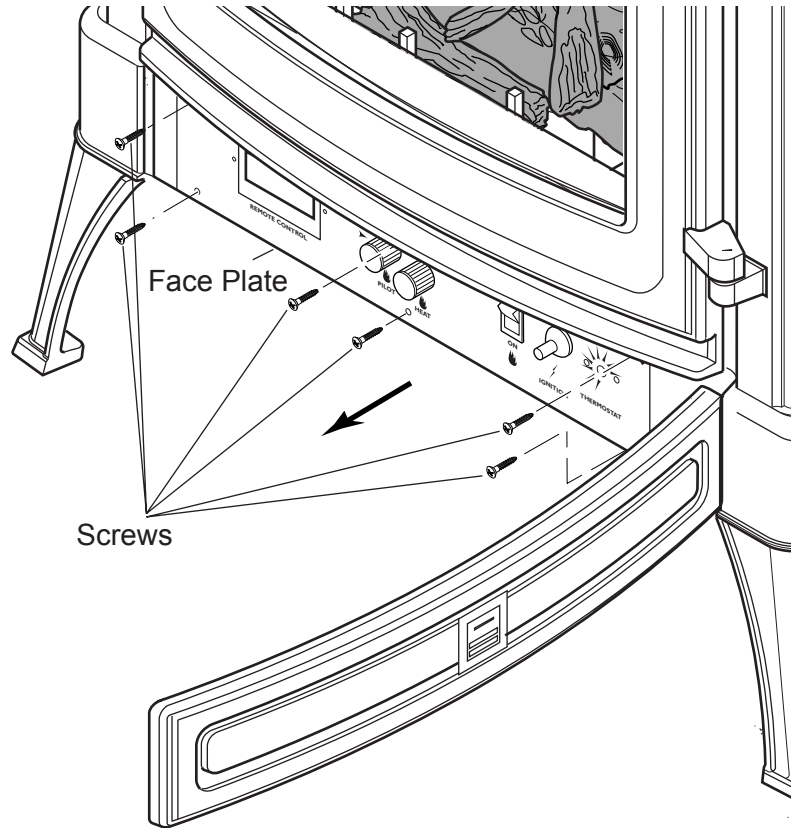

Figure 8 - Removing Face Plate from Stove

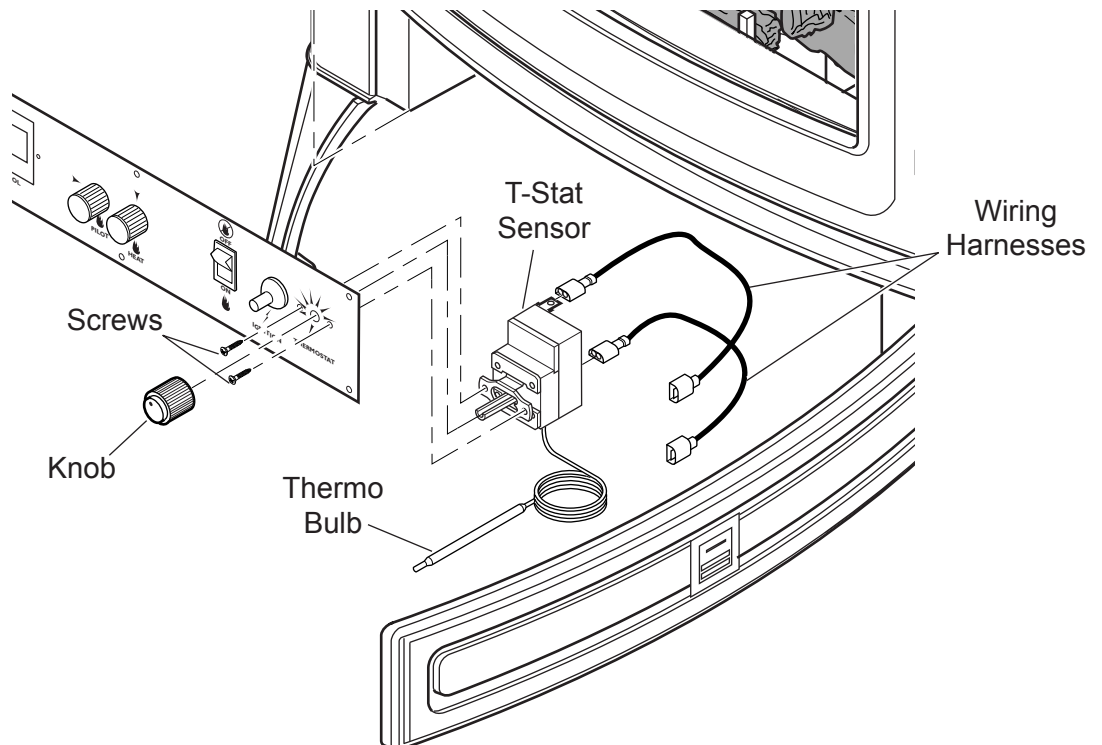

Figure 9 - Installing T-Stat Sensor and Control Knob

4. Remove adhesive backing from plastic clip. Press clip to bottom of valve. Clip thermo bulb into plastic clip. *See Figure 10.*
5. Reattach faceplate or reinstall base.
6. Install knob to shaft of t-stat sensor. *See Figure 9, page 14.*

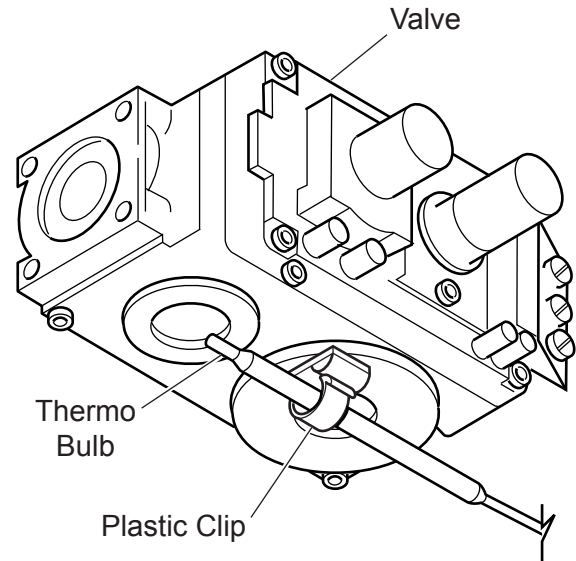

Figure 10 - Clipping Thermo Bulb into Plastic Clip.

OPERATION OF THERMOSTAT SENSOR

1. Follow millivolt lighting instructions on lighting plate attached to unit or in homeowner's manual.
2. With control knob in the "ON" position make sure the ON/OFF switch is in the "OFF" position. *See Figure 11.*
3. The unit is now being controlled by the thermostat sensor. The sensor will now cycle the burners on and off. You can adjust how often the unit cycles by turning the control knob on the sensor.

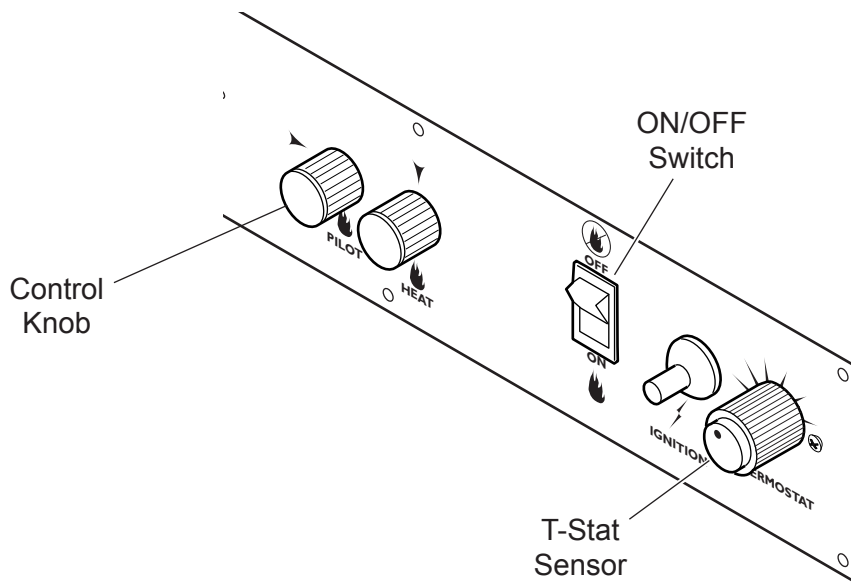

Figure 11 - Control Knob in "ON" Position and ON/OFF Switch in "OFF" Position

LOG PLACEMENT

Before you begin — This unit is supplied with four ceramic fiber logs. Do not handle these logs with your bare hands. **Always wear gloves to prevent skin irritation from ceramic fibers.** After handling the logs, wash your hands gently with soap and water to remove any traces of fibers.

WARNING

The positioning of the logs are critical to the safe and clean operation of this heater. Sooting and other problems may result if the logs are not properly and firmly positioned in the appliance. Never add additional logs or embellishments such as pine cones, vermiculite or rock wool to the heater. Only use the logs supplied with the unit.

Failure to position the parts in accordance with diagrams below or to use only parts specifically approved for this heater may result in property damage or personal injury.

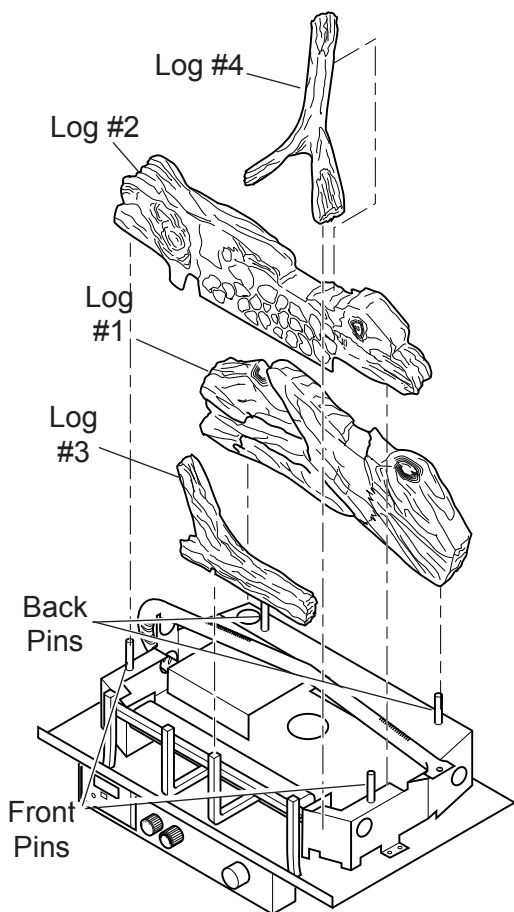

Figure 12 - Installing Logs to Grate

INSTALLING LOGS ON GRATE (See *Figure 12*)

1. Install back log (#1) on two pins located near the back of base. Check log position and stability.
2. Install center log (#2) on two pins located near the front of the base.
3. Install front log (#3) in front of center log. Make sure bottom of log is resting on the grate. Do not rest log on burner.
4. Place back end of top center log (#4) on recessed area of back log (#1) and rest on pin on center log (#2).

CAUTION

DO NOT sprinkle volcanic rocks on the logs or around the pilot. This may cause sooting. During initial operation of the new heater, burning logs will give off a paper burning smell and orange flames will be present. Simply open the windows for a few hours to vent the odor.

Flames from the pilot, front and rear burner should be visually checked as soon as the heater is installed. In addition, periodically check the flames visually during operation.

CHECKING PILOT FLAME

The pilot flame must always be present when the heater is in operation. It should just touch the top of the thermocouple tip for natural. See Figure 13 for correct pilot flame.

If the pilot flame does not touch the thermocouple, then the burners cannot function reliably. See Figure 14 for incorrect shape of pilot flame.

MILLI-VOLT CONTROL

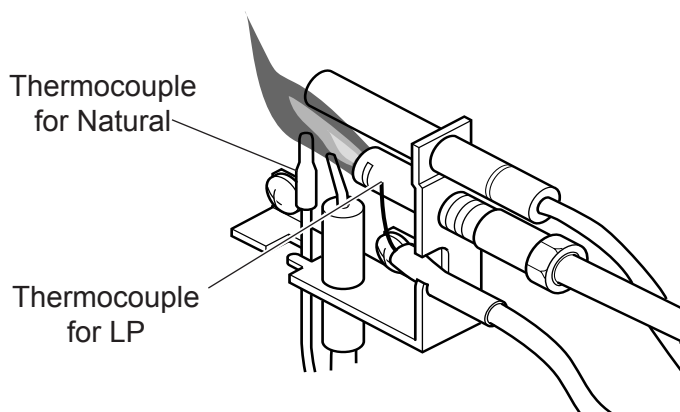

Figure 13 - Correct Appearance of Pilot Flame

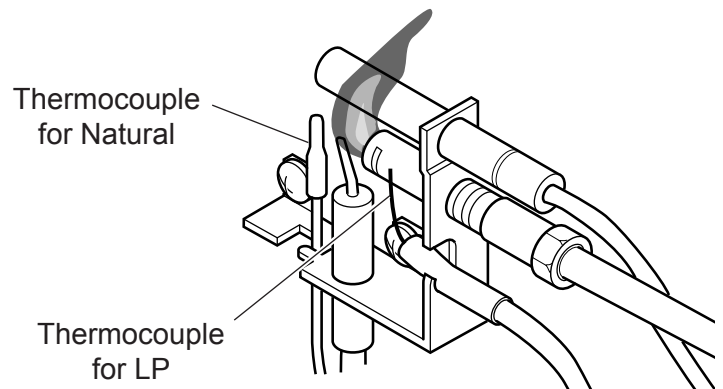

Figure 14 - Incorrect Appearance of Pilot Flame

CHECKING BURNER FLAME

In normal operation at full rate after 15 minutes, the following flame appearances should be observed:

The left and right rear flames should be yellow and extend 1"-2" above the log top surfaces. The yellow flames should **not** contact the logs. There should be glowing embers on the front surface of the middle log. **Note: The flames and embers will be an opaque orange color during the burn off time.**

OPERATING INSTRUCTIONS

Avoid any drafts that alter burner flame patterns. Do not allow fans to blow directly into the stove. Do not place a blower inside the burn area of the stove. Ceiling fans may create drafts that alter flame patterns. Sooting and improper burning will result.

During manufacturing, fabricating and shipping, various components of this appliance are treated with certain oils, films or bonding agents. These chemicals are not harmful, but may produce annoying smoke and smells as they are burned off during the initial operation of the appliance, possibly causing headaches or eye or lung irritation. *This is a normal and temporary occurrence.*

The initial break-in operation should last two to three hours with the burner at the highest setting. Provide maximum ventilation by opening windows or doors to allow odors to dissipate. Any odors remaining after this initial break-in will be slight and will disappear with continued use.

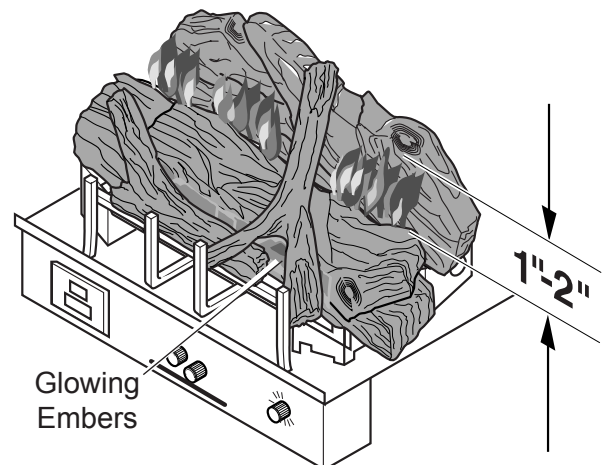

Figure 15 - Correct appearance of Embers and Rear Flame

OPERATING INSTRUCTIONS

FOR YOUR SAFETY READ BEFORE LIGHTING

WARNING

If you do not follow these instructions exactly, a fire or explosion may result causing property damage, personal injury or loss of life.

- A. This appliance is equipped with an ignition device which automatically lights the pilot. If the piezo is not working properly, see "Match Lighting Instructions," page 21.
- B. BEFORE OPERATING smell all around the appliance area for gas. Be sure to smell next to the floor because some gas is heavier than air and will settle on the floor.

WHAT TO DO IF YOU SMELL GAS:

- Do not attempt to light any appliance.
 - Do not touch any electric switch; do not use any phone in your building.
 - Immediately call your gas supplier from a neighbor's phone. Follow the gas supplier's instructions.
 - If you cannot reach your gas supplier, call the fire department.
- C. Use only your hand to push in, or turn the gas control knob. Never use tools. If the knob will not push in or turn by hand, don't try to repair it. Call a qualified service technician. Force or attempted repair may result in a fire or explosion.
 - D. Do not use this appliance if any part of it has been under water. Immediately call a qualified service technician to inspect the appliance and to replace any part of the control system and any gas control that has been under water.

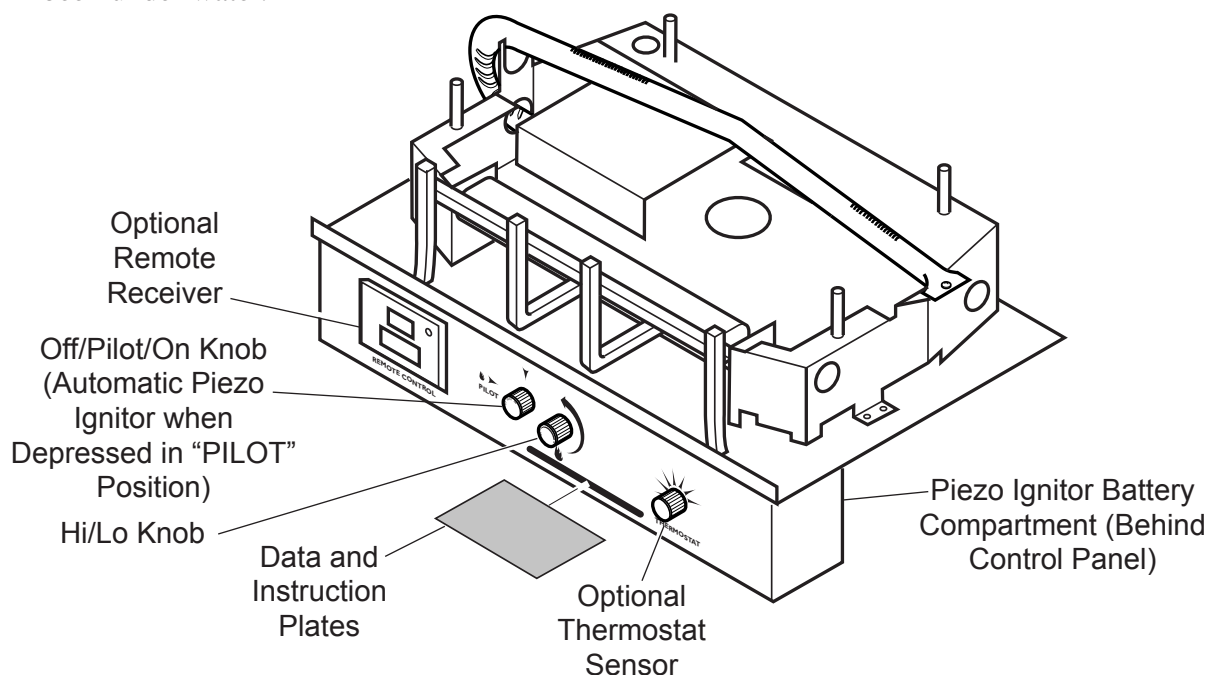





Figure 16 - Location of Piezo Ignitor, Control Knobs and Switch on Milli-volt Unit

MILLI-VOLT CONTROL LIGHTING INSTRUCTIONS

1. STOP! Read the safety information label.
2. Make sure the manual shutoff valve is fully open.
3. This gas log set is equipped with an ignition device (piezo) which automatically lights the pilot. If piezo ignitor does not light the pilot, refer to instructions for “Match Lighting Instructions”, page 21.
4. Turn gas control knob clockwise  to the OFF position, set the thermostat to the lowest setting and turn ON/OFF switch to OFF position.
5. Wait (5) minutes to clear out any gas. Then smell for gas, including near the floor. If you smell gas, STOP! Follow the instructions under “What To Do if You Smell Gas,” page 16. If you don’t smell gas, go to next step.
6. From OFF position, turn the gas control knob counterclockwise  to IGN position. Push in control knob for 5 seconds. **NOTE: If you are running the heater for the first time, it will be necessary to press in the control knob for 30 seconds or longer to allow air to bleed out of the gas piping.**
7. With the control knob pushed in, the battery powered ignition will light the pilot.
8. Continue pushing the control knob in for a further 10 seconds to prevent the flame detector from shutting off the gas while the probe is warming up. Release the control knob.
9. Turn gas control knob counterclockwise  to the ON position.
10. After the pilot has been lit for one minute, the burners can be turned on. Turn the ON/OFF switch to ON position or adjust thermostat to desired setting. **NOTE: To use the optional thermostat function (if installed), the control knob must be set to “ON” and the ON/OFF Switch must be in the “OFF” position.**
11. If the gas logs will not operate, follow the instructions “To Turn Off Gas To Heater” below and call your service technician or gas supplier.

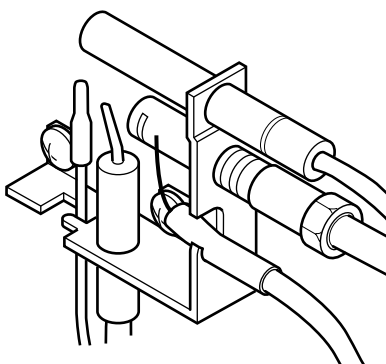

Figure 17 - Pilot

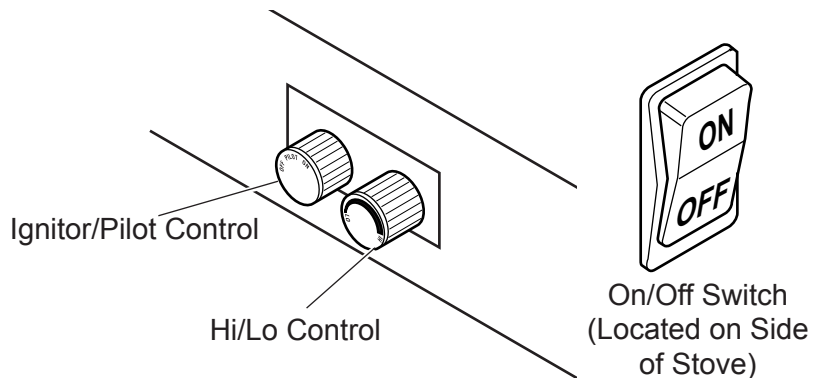



Figure 18 - Control Cover Plate for Milli-Volt

TO TURN OFF GAS TO HEATER

1. Turn control knob clockwise  to OFF position to completely shut off the heater.
2. If applicable: Turn ON/OFF switch to OFF position and/or set thermostat (if present) to lowest setting.
3. If applicable: Turn off all electric power to the heater.

MATCH LIGHTING INSTRUCTIONS

1. Open stove door. Remove any items necessary for easy access to the pilot (for example: logs, screens, etc.).
2. Follow appropriate lighting instructions found previously. Light a match and hold the flame to the end of the pilot and ignite the pilot.
3. After control knob has been released and pilot stays lit, reinstall any items that were removed for pilot access. Close and latch stove door.
4. Replace ignitor batter. If ignitor still does not work, then call a qualified service technician for repair or replacement of the piezo ignitor.

CLEANING AND SERVICING

Annual inspection and cleaning by your dealer or qualified service technician is recommended to prevent malfunction and/or sooting.

WARNING

Turn off heater and allow to cool before cleaning. Disconnect electrical power before cleaning or servicing.

Remove logs, handling carefully by holding gently at each end. Gloves are recommended to prevent skin irritation from ceramic fibers. If skin becomes irritated, wash gently with soap and water. Refer to manual for correct log placement.

PERIODIC CLEANING - See parts diagram for location of items discussed below.

- Do not use cleaning fluid to clean logs or any part of heater.
- Brush logs with soft bristle brush or vacuum with brush attachment.
- Vacuum loose particles and dust from the front and rear burners, control and piezo covers and grate weldment.
- Inspect and clean burner air intake holes. Remove lint or particles with vacuum, brush, or pipe cleaners. Failure to keep air intake holes clean will result in sooting and poor combustion.
- External case should be dusted and wiped with a moist cloth.

ANNUAL CLEANING/INSPECTION - Refer to parts diagram for location of items discussed below.

- Inspect and clean burner air intake holes. Remove lint or particles with vacuum, brush or pipe cleaners. Failure to keep air intake holes clean will result in sooting and poor combustion.
- Inspect and clean all burner ports.
- Inspect ODS pilot for operation and accumulation of lint at air intake holes.
- Verify flame pattern and log placement for proper operation.
- Verify smooth and responsive ignition of main burner and rear burner.
- Replace AA battery in ignition module.

REPLACEMENT PARTS ARE AVAILABLE THROUGH YOUR RETAILER.

LOGS

Item	Description	Qty	
1	Back Log	1	44D1011K
2	Middle Log	1	45D0502K
3	Front Log	1	44D1012K
4	Top Log	1	44D1013K

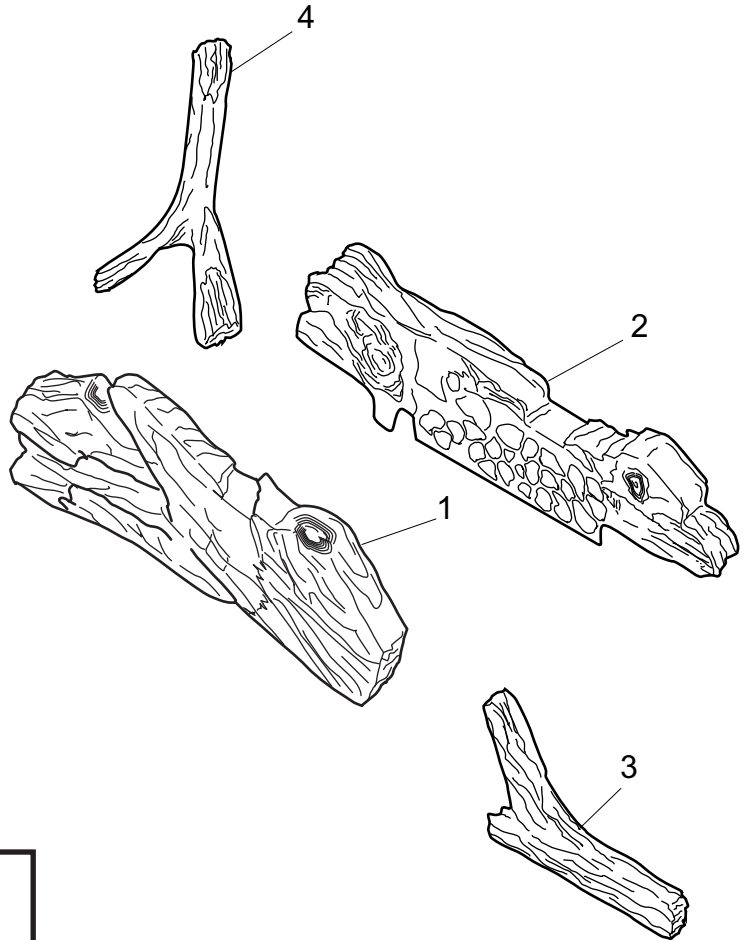

WARNING Failure to position the parts in accordance with these diagrams or failure to use only parts specifically approved with this appliance may result in property damage or personal injury.

REPLACEMENT PARTS

BURNER ASSEMBLY

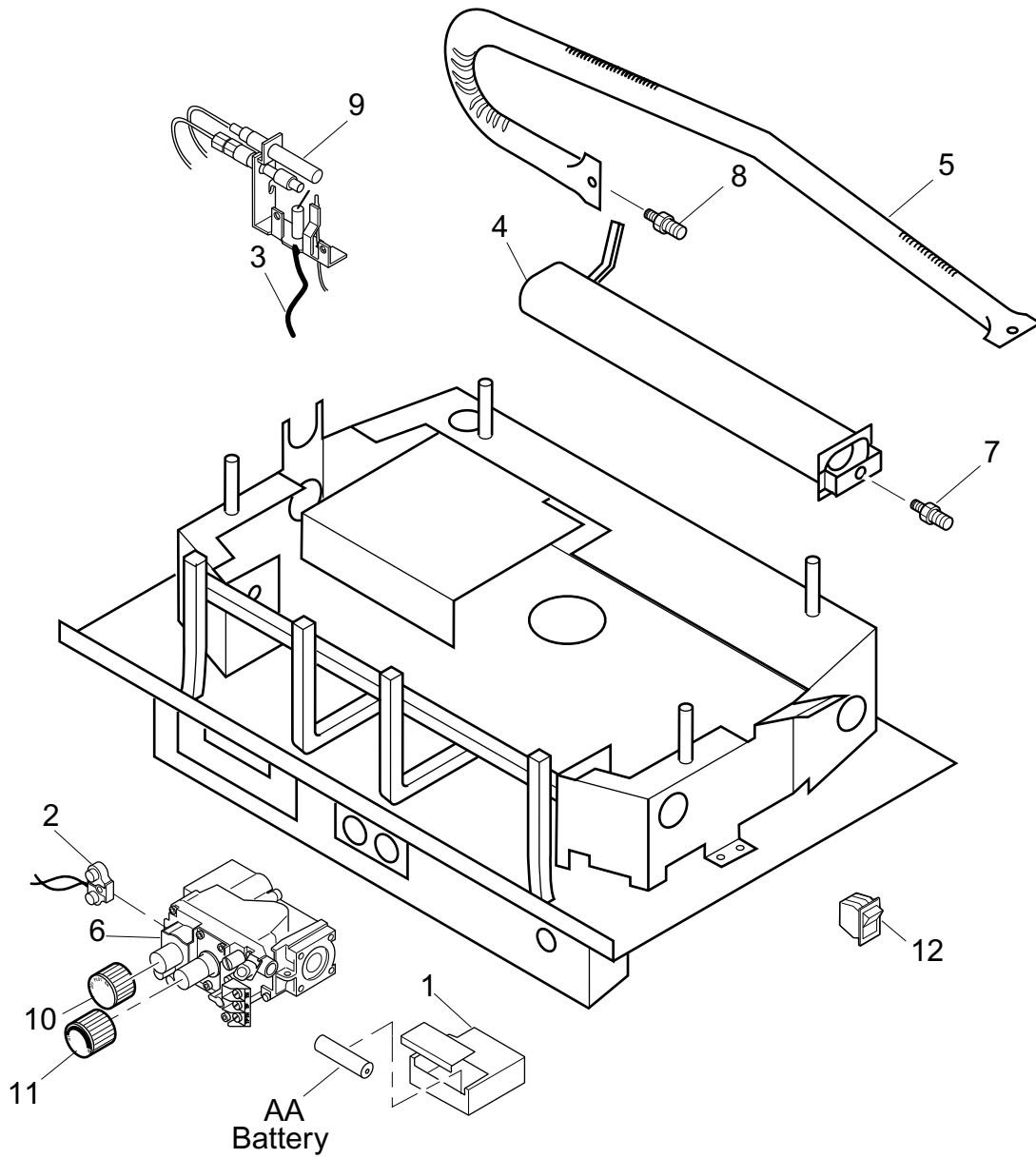

WARNING

Failure to position the parts in accordance with these diagrams or failure to use only parts specifically approved with this appliance may result in property damage or personal injury.

REPLACEMENT PARTS LIST

REPLACEMENT PARTS ARE AVAILABLE THROUGH YOUR RETAILER.

BURNER ASSEMBLY

Item	Description	Qty	C2801/02/03/04VF	
			Natural	Propane
1	Piezo Ignition Module	1	45D0077	45D0077
2	Piezo Switch	1	45D0078	45D0078
3	Piezo Wire	1	00K0632	00K0632
4	Front Burner	1	44D0020K	44D0020K
5	Rear Burner	1	45D0527K	45D0530K
6	Control Valve	1	14D0467	14D0468
7	Front Burner Injector	1	44D0208	44D0210
8	Rear burner Injector	1	44D0209	44D0211
9	ODS Pilot Assembly	1	14D0473	14D0474
10	On/Off Control Knob	1	43D0094	43D0094
11	Hi/Lo Control Knob	1	43D0095	43D0095
12	On/Off Switch	1	32D0232	32D0232
	Homeowners Manual	1	45D0080	45D0080

Accessories

Flex Connector	Flexcon 30
Wall Switch Kit	MVWS
Wall Thermostat Kit	MVWTS
Hand Held Remote	RCM
Hand Held Thermostat Remote	RCT
Thermostat Control Sensor	TS

TROUBLESHOOTING

WARNING

Turn appliance OFF and allow to cool before servicing. Only a qualified service person should service and repair the heater.

Note: All troubleshooting items are listed in order of operation.

OBSERVED PROBLEM	POSSIBLE CAUSE	REMEDY
When ignitor button is pressed, there is no spark at ODS/pilot.	<ol style="list-style-type: none"> 1. Ignitor electrode positioned wrong. 2. Ignitor electrode is broken. 3. Ignitor electrode not connected to ignitor cable. 4. Ignitor cable pinched or wet. Keep ignitor cable dry. 5. Broken ignitor cable. 6. Bad piezo ignitor. 7. No battery power (auto spark). 	<ol style="list-style-type: none"> 1. Replace ignitor. 2. Replace ignitor. 3. Reconnect ignitor cable. 4. Free ignitor cable if pinched by any metal or tubing. 5. Replace ignitor cable. 6. Replace piezo ignitor. 7. Replace battery.
Appliance produces unwanted odors.	<ol style="list-style-type: none"> 1. Appliance burning vapors from paint, hair spray, glues, etc. 2. Gas leak. 3. Initial burn off. 	<ol style="list-style-type: none"> 1. Ventilate room. Stop using odor causing products while heater is running. 2. Locate and correct all leaks. 3. Ventilate room and turn unit on high until odor is gone. Odor should be gone after 2 to 3 hours of continuous use.
Appliance shuts off during use.	<ol style="list-style-type: none"> 1. Not enough fresh air is available for ODS/ pilot to operate. 2. Low line pressure. 3. ODS/pilot is partially clogged. 4. Defective Thermopile. 5. Restrictions in incoming air flow. 	<ol style="list-style-type: none"> 1. Open window and/or door for ventilation. 2. Contact local gas company. 3. Clean ODS/pilot. 4. Check pilot flame. Check wire connections. Check thermopile output — should be 500 milli-volts across TH/TP and TP Terminals with ON/OFF switch off. 5. Check for obstructions on bottom of unit. Check for improper log placement.
Gas odor even when control knob is in OFF position.	<ol style="list-style-type: none"> 1. Gas leak. 2. Control valve defective. 	<ol style="list-style-type: none"> 1. Locate and correct all leaks. 2. Replace control valve.
When ignitor button is pressed, there is spark at ODS pilot, but no ignition.	<ol style="list-style-type: none"> 1. Gas supply turned off or appliance shutoff valve closed. 2. Air in gas lines when installed. 3. ODS/pilot is clogged. 4. Gas regulator setting is not correct (LPG). 	<ol style="list-style-type: none"> 1. Turn on gas supply or open manual shutoff valve. 2. Continue holding down control knob. Repeat igniting operation until air is removed. 3. Replace ODS/pilot assembly or get it serviced. 4. Replace gas regulator at tank.

WARNING

If the gas quality is bad, your pilot may not stay lit, the burners may produce soot and the heater may backfire when lit. If the gas quality or pressure is low, contact your local gas supplier immediately.

OBSERVED PROBLEM	POSSIBLE CAUSE	REMEDY
ODS/pilot lights, but flame goes out when control knob is released.	<ol style="list-style-type: none"> Control knob not fully pressed in. Control knob not pressed in long enough. Appliance shutoff valve not fully open. Thermocouple connection loose at control valve. Pilot flame not touching thermocouple, which allows thermocouple to cool, causing pilot flame to go out. Thermocouple damaged. Control valve damaged. 	<ol style="list-style-type: none"> Press in control knob fully. After ODS/pilot lights, keep control knob pressed in for 30 seconds. Fully open manual shutoff valve. Hand tighten thermocouple connection until snug, then tighten 1/4 turn more. Contact local gas company. This problem could be caused by either low gas pressure, or a dirty or partially clogged ODS/pilot. Replace pilot. Replace control valve.
Burner does not light after ODS/pilot is lit.	<ol style="list-style-type: none"> Inlet gas pressure is too low. Burner orifice diameter is too small. Burner orifice is clogged. 	<ol style="list-style-type: none"> Contact qualified service person. Replace burner orifice. Clean orifice.
Burner backfires during combustion.	<ol style="list-style-type: none"> Manifold pressure is too low. Burner orifice is clogged. 	<ol style="list-style-type: none"> Contact local gas company. Clean burner or replace burner orifice.
Slight smoke or odor during initial operation.	<ol style="list-style-type: none"> Burner orifice is clogged or damaged. Burner is damaged. Gas regulator defective. 	<ol style="list-style-type: none"> Clean burner or replace burner orifice. Replace burner. Replace gas regulator.
Logs appear to smoke after initial operation.	<ol style="list-style-type: none"> Vapors from paint or curing process of logs. 	<ol style="list-style-type: none"> Problem will stop after a few hours of operation. Open a window for the first few hours. Log heater is intended to be smokeless. Turn OFF heater and call qualified service person.
Heater produces a whistling noise when burner is lit.	<ol style="list-style-type: none"> Turning control knob to HIGH position when burner is cold. Air in gas line. Dirty or partially clogged burner orifices. 	<ol style="list-style-type: none"> Turn control knob to LOW position and let warm up for a minute. Operate burner until air is removed from line. Have gas line checked by local gas company. Clean burner or replace burner orifice.
No gas to pilot.	<ol style="list-style-type: none"> LP-regulator shut down due to inlet pressure too high. 	<ol style="list-style-type: none"> Verify LP tank regulator is installed and set at 11" to 13" w.c.

NOTES

LEXINGTON FORGE

LIMITED LIFETIME WARRANTY POLICY

LIFETIME WARRANTY

The following components are warranted for life to the original owner, subject to proof of purchase: Firebox, Combustion Chamber, Heat Exchanger, Grate and Stainless Steel Burners.

FIVE YEAR WARRANTY

The following components are warranted for 5 years to the original owner, subject of proof of purchase: Ceramic Fiber Logs, Catalytic Filter and Aluminized Burners.

BASIC WARRANTY

Monessen Hearth Systems (MHS) warrants the components and materials in your gas appliance to be free from manufacturing and material defects for a period of one year from date of installation. After installation, if any of the components manufactured by MHS in the appliance are found to be defective in materials or workmanship, MHS will, at its option, replace or repair the defective components at no charge to the original owner. MHS will also pay for reasonable labor costs incurred in replacing or repairing such components for a period of one year from the date of installation. Any products presented for warranty repair must be accompanied by a dated proof of purchase.

This Limited Warranty will be void if the appliance is not installed by a qualified installer in accordance with the installation instructions. The Limited Lifetime Warranty will also be void if the appliance is not operated and maintained according to the operating instructions supplied with the appliance, and does not extend to (1) firebox/burner assembly damage by accident, neglect, misuse, abuse, alteration, negligence of others, including the installation thereof by unqualified installers, (2) the costs of removal, reinstallation or transportation of defective parts on the appliance, or (3) incidental or consequential damage. All service work must be performed by an authorized service representative.

This warranty is expressly in lieu of other warranties, express or implied, including the warranty of merchantability of fitness for purpose and of all other obligations or liabilities. Monessen Hearth Systems, Inc. does not assume for it any other obligations or liability in connection with the sale or use of the appliance. In states that do not allow limitations on how long an implied warranty lasts, or do not allow exclusion of indirect damages, those limitations of exclusions may not apply to you. You may also have additional rights not covered in this Limited Warranty.

MHS reserves the right to investigate any and all claims against the Limited Warranty and decide upon method of settlement.

For information about this warranty, contact:

**Technical Services
Monessen Hearth Systems
149 Cleveland Drive
Paris, Kentucky 40361**