

How to use your dishwasher

1555

Important!

Read all operating instructions
before using your dishwasher for the
first time, in order to obtain the best
performance from it.

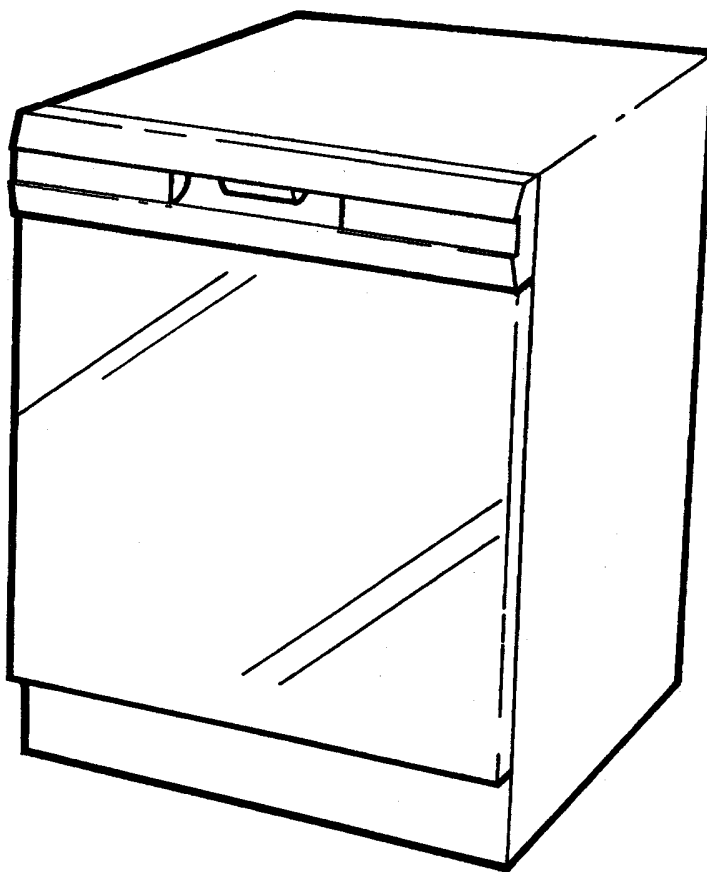

Contents

How to use the machine	2
The parts of the machine	2
Loading the baskets	5
Detergent	6
Technical data	6
Wash these items with care	7
How to use the Model 1555	8-9
Which program should I use?	8
Energy saving	9
Options	8-9
Indicating lamps	12
Care of the machine	13
Filling with rinse aid	13
Adjusting the rinse aid dispenser	14
Dishwashers with water softeners:	
Filling with salt	14
Adjusting the salt dispenser	14
Safety	15
If the machine won't work	16-18
Product Warranty	19
Instructions summary	20

Before using the machine for the first time
Read this entire manual right through these instructions.
Certain materials should not be washed in dishwashers (see page 7).
Use only dishwasher detergent.

Important Safety Instructions

WARNING: When using your dishwasher, follow basic precautions, including the following:

1. Read all instructions before using the dishwasher.
2. This dishwasher must be properly grounded: see installation instructions for details.
3. Use the dishwasher only for its intended purpose.
4. Use only detergents or rinse aids recommended for use in a dishwasher, and then keep them out of reach of children.
5. When loading items to be washed:
 - a. Locate sharp items, so that they are not likely to damage the door seal.
 - b. Load sharp knives with the sharp points down to reduce risk of cut-type injuries.
6. Do not wash plastic items unless marked "dishwasher safe": or the equivalent. For plastic items not so marked, check the manufacturer's recommendations.
7. Do not touch the heating element during or immediately after use.
8. Do not operate your dishwasher unless all enclosure panels are properly in place.
9. Do not tamper with controls.
10. Do not abuse, sit on or stand on the door or dish rack of the dishwasher.
11. To reduce the risk of injury, do not allow children to play in or on a dishwasher.
12. Under certain conditions, hydrogen gas may be produced in a hot water system that has not been used for two weeks or more. Hydrogen gas is explosive. If the hot water system has not been used for such a period, turn on all hot water faucets and let the water flow from each for several minutes. This will release any accumulated hydrogen gas. Since the gas is flammable, do not smoke or use an open flame during this process.
13. Remove the door to the washing compartment when removing an old dishwasher from service or discarding it.

More about SAFETY on page 15

More about SAFETY on page 15

Save These Instructions

How to use your new dishwasher

Follow the steps in the strip along the top of each page for a brief summary of the instructions.

Further details and advice are on the page below the strip.

The parts of the machine

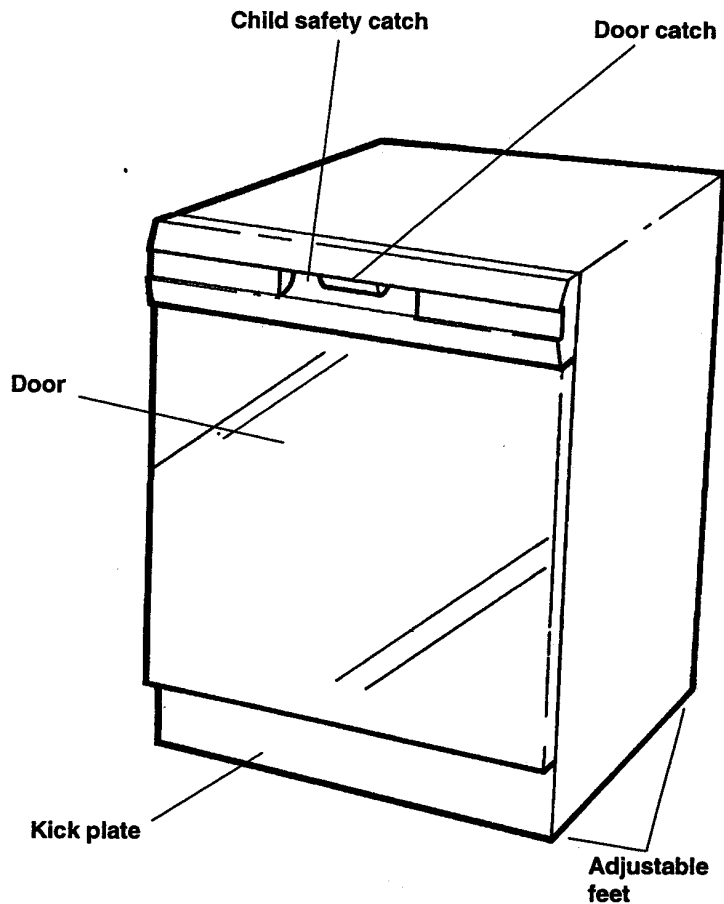

The kick plate can be adjusted inwards and outwards to match the depth of kitchen toe kick (see Installation Book)

The kick plate can be adjusted vertically to match the height of kitchen cabinets (see Installation Book)

① Open the door by pulling the handle forwards and upwards.

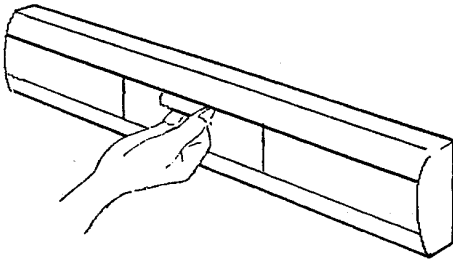

How to open the door if the child safety catch is engaged:

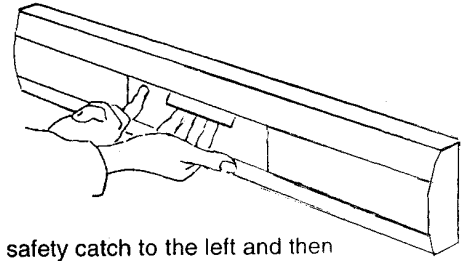

Slide the safety catch to the left and then lift the handle upwards.

Program panel

See pages 8–9

Programs

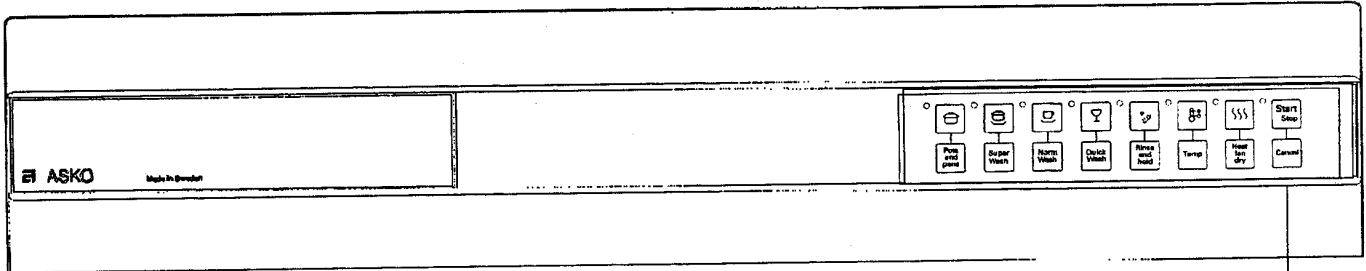

Start/Stop

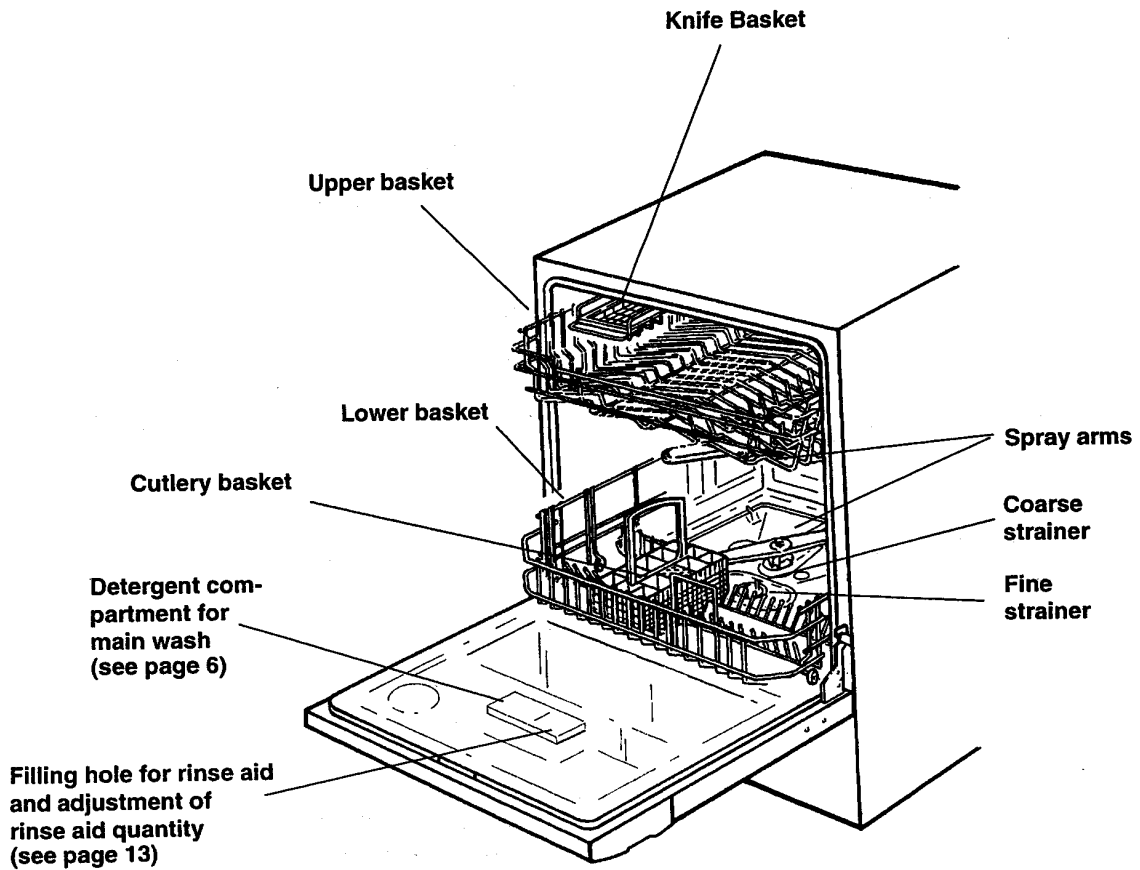

② Load the baskets

Be careful when washing items made of certain materials (see page 7).

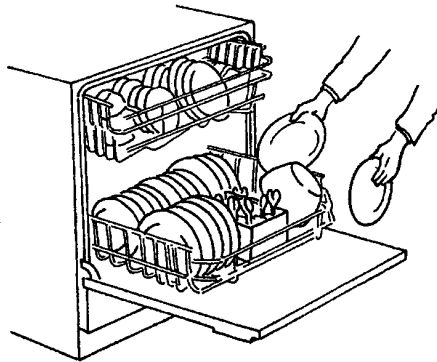

③ Add detergent

Pre-wash: on the inside of the door

Main wash: in the detergent compartment

Close the door after you have added the detergent.

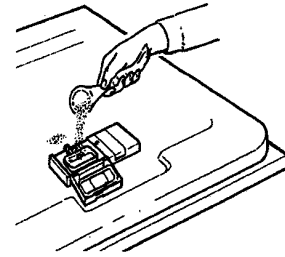

Upper basket

Load glasses, cups, bowls, small plates, saucers, long items of cutlery and carving knives into the upper basket. (Take care that sharp edges do not damage the coating of the baskets.)

The upper basket has two hinged racks. The waved rack is for wine glasses.

When the hinged rack is folded down, cups can be placed on it and under it. There is space for tall glasses with the rack folded up.

NOTE: place the items so that the detergent dispenser is not prevented from opening.

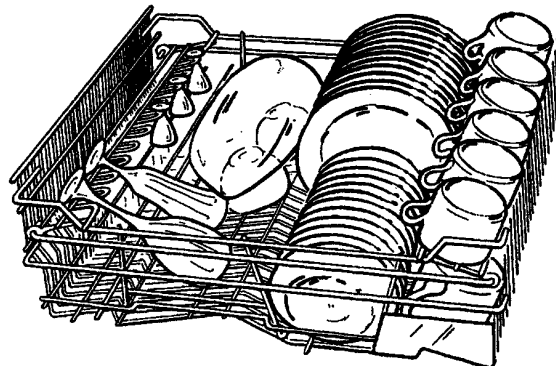
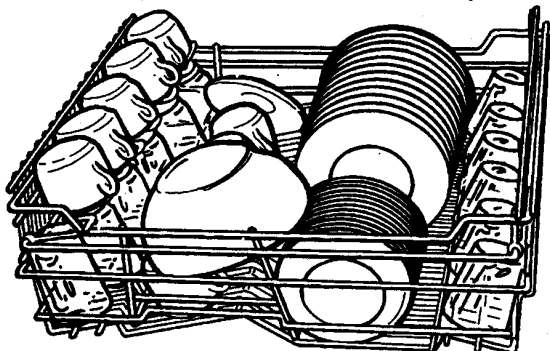

Placing of wine glasses

Lower basket

Load large and small plates, serving dishes, pots and pans and cutlery (in the cutlery basket) into the lower basket.

The lower basket has an insert rack for plates. Remove it to provide space for casseroles and saucepans.

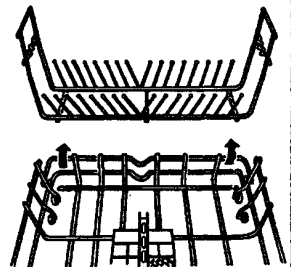

The insert rack can be removed to provide space for saucepans and casserole dishes.

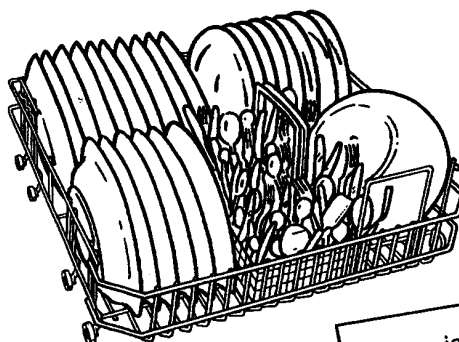
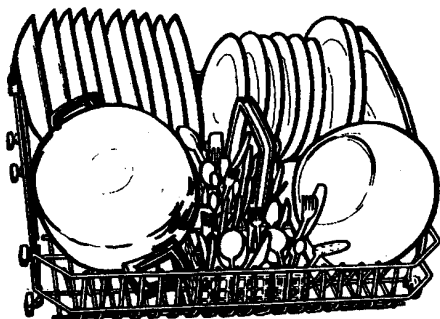

All used surfaces must face downwards.

There is no need to rinse items before you load the machine, although larger food particles should be removed.

- ④ Check that the spray arms can rotate freely.

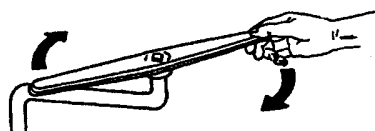

- ⑤ Check that the water supply is turned on.

- ⑥ Close the door.

Close the door fully: if not, the machine will not start.

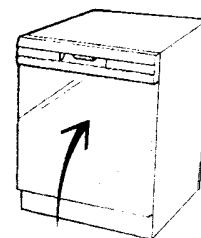

Cutlery basket

Load cutlery with the handles downwards and as spread out as possible. Make sure that spoons do not 'nest' with each other. Avoid placing cutlery of different metals – e.g. silver and stainless steel – in the same compartment. It is also unsuitable to place different grades of stainless steel (check by the surface colour) in contact.

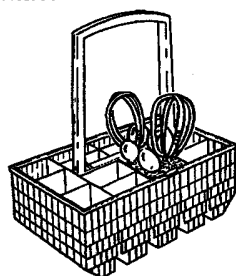

The cutlery basket has a folding cover in the middle. It can be used to protect small items, but you can also put thin handles as electric whisks through the folded cover.

Knife basket

The separate knife or farge utility basket is used for long knives or spatular.

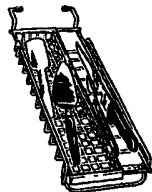

How much detergent?

The amount of detergent required depends on the program used and the water hardness (see below).

Pots and Pans,
Super Wash,
Normal wash

Pre-wash (1-2 T-spoons)
Main wash (1-3 TBS)

Quick wash

Main wash (1-3 TBS)

Use only dishwasher detergent

for both pre-wash and main wash. Ordinary hand dish-washing detergent must not be used, as the foam will interfere with proper operation of the machine.

The amount of detergent depends on the hardness of the water

Water hardness varies from place to place, and is measured in degrees of hardness (°dH). Your water company should be able to tell you the hardness of water in your area. The harder the water, the more detergent you will need. Follow the instructions on the packet.

In hard water areas, both the dishes and the machine can develop a grey film after a while. This can be removed by using the machine with the pre-wash detergent replaced by two tablespoonsful of citric acid. Use the pots and pans program.

If the water is very hard, use a rinse aid that contains citric acid (acid rinse aid).

Filling of rinse aid (and salt, if appropriate): see pages 13-14.

Technical details

Height	32 1/4"-35"
Width	24
Depth	22
Weight	100 lbs. 105 lb softener
Capacity	12 place settings (IEC)
Water pressure	20-147 PSI
Voltage	120 V, 60 Hz
Max power	1650 W
Heater	1400 W



Warning!

Dishwasher detergent is corrosive – take care to keep it out of the reach of children.

Make sure that children cannot get hold of dishwasher detergent. If any is accidentally swallowed, give plenty to drink: one or two glasses of milk or water. **Do not try to induce vomiting.** Seek medical advice without delay. If dish-washer detergent gets in the eyes, rinse with plenty of water.

What can be washed in the dishwasher?

Most household goods such as plates, saucepans and flatware can be machine washed. If you are unsure, check with the manufacturer or, if this is not possible, wash one set over an extended period of time and then compare it with the rest of the set.

The user is responsible for what he or she washes in the dishwasher.

Material	Dishwasher safe?	Information
Aluminum	Yes	Anodized aluminum may fade or darken. Patches and discoloration may appear but these can be removed with wire wool. Remember not to position aluminum utensils so that they come in direct contact with the dishwasher detergent since this may result in black spots and small erosion holes.
Cast Iron	No	The seasoning is lost and the iron rusts. Hand wash.
China Stoneware	Yes	China without decor or with decor protected by glaze is dishwasher safe. Remember however to place the objects so that they are not in contact with each other, otherwise they can be damaged. China with a pattern on top of the glaze, or with gold leaf decor may fade. Check with the manufacturer. If this is not possible, try with one of the items over an extended period. Then compare its colors and patterns with the rest of the set.
Crystal	No Yes	Antiques and very delicate china should not be washed in the dishwasher. Place the items so that they cannot fall over or knock against each other while being washed. Certain types of lead crystal may etch if they are machine washed. Check with your supplier. Refer to china above for colored patterns or gold leaf decor. Antiques and very delicate items should not be machine washed. Use a low wash temperature.
Dirilyte	No	Gold-colored flatware can become discolored.
Glass	Yes	Milk glass may become yellowed.
Flatware with bonded handles	No	Certain types of adhesives cannot stand machine washing and may loosen.
Pewter	No	Pewter tarnishes.
Disposable plastic item	No	Cannot withstand machine washing.
Plastic	Yes	If the item is not marked "Dishwasher safe", test one of the items before the whole set is washed. Place plastic items in the top basket. Use drying without heat.
Stainless steel	Yes	Rinse the items if they are not going to be washed immediately. Salty or acidic foods can stain if left on. Dry dishwasher detergent can also produce black marks which are difficult to remove. Do not let copper items come in contact with stainless steel. Do not mix different types of stainless steel.
Silver and silver plate	Yes	Rinse the items if they are not going to be washed immediately. Food which contains a lot of salt or acids produces marks. Dry dishwasher detergent can also produce black marks which are difficult to remove. Do not put in same silverware basket with stainless steel. Contact between the metals can damage silver. Do not wash copper utensils with the same load. Silver may get a brown film. Adhesive used to attach some hollow-handle knives can loosen.
Non-stick coatings	Yes	After washing, wipe the non-stick coating area with vegetable oil to keep it from losing its non-stick quality.
Tin	No	Can rust.
Wood	No	Check the manufacturer's recommendation before washing. Wood can warp, crack or lose its shape with any kind of washing.
Non-dishware items-such as electronic air cleaner filters, furnace filters, paint brush, etc.	No	Do not wash in dishwasher. Damage to dishwasher may result.
Sharp kitchen (carving) knives	No	May become dull if washed in very hot water or allowed to contact other items during the washing process. Wood handles may also warp, crack or loosen. Check manufacturer's washing instructions.

How to use your Model 1555

Your Model 1555 is a dishwasher which is particularly convenient to use. It remembers the program that was last used (program 1-3), so you need only press the Start pushbutton to use it again.

The machine also shows when the rinse aid or salt has run out or when you have not closed the door properly.

- Press the power switch

- Select the program

As soon as power is given to the machine, a lamp lights above the last selected program (program 1-3). Simply press the Start pushbutton to use this program again. To use a different program, press the pushbutton for the program required.

Which program should I use?

The easiest way of using the machine is to select a standard program. Simply press one of the four symbols for the dishwashing programs that you want, and the machine does the rest. Or you can select the washing temperatures, number of rinses, heated drying and so on yourself: read the details below and follow the table.

If you have used program 1, 2 or 3 by the last wash, the machine remembers it and you need only press the Start pushbutton to get the same program. But if you use program 4, you must select it every time. The reason for this is that we mean that the Light wash (4) shall just be used at special occasions, when the dishes are very slightly soiled.



1. Pots & Pans

Use the Pots & Pans wash program for very dirty dishes, such as pots, pans, casseroles and gratin forms.



2. Super Wash

Use this program for dirty dishes that have been sitting on table with dried food on them.



3. Normal wash

Use this program for normal washing. It is made for plates, cups and saucers and one or two not so dirty pans.



4. Light wash

If the wash is not particularly heavily soiled, use the Light wash program. It is provided for glasses and china, which are washed immediately after being used and therefore don't need a stronger program.

Delicate items

Delicate items can be washed with the Light wash program. Omit heating if you want to be extra careful. See also page 7: What can be washed in the dishwasher?



5. Rinse & Hold

For rinsing the dishes if you are waiting to wash-up until the machine is full.

Programs	Symbols
Pots & Pans	
Super Wash	
Normal wash	
Light wash	
Rinse & Hold	

Program options

Temperature

By pressing you can select temperature in the programs:
 Pots & Pans: 160/130° F
 Super wash: 150/130° F
 Normal wash: 150/130° F
 Light wash: 130/110° F

Heated drying

Lights if you have selected heated drying. Press the pushbutton again to cancel heated drying. Then the lamp goes out, but the fan will run to remove the moisture.

Salt indicator

(Only for machines with water softeners)

This lamp lights to indicate that the machine has run out of salt. After refilling, there may be some delay before the lamp goes out.

The lamp is lit at the higher temperature. Selected temperatures remain until you alter them. Note that 110° F will not remain.

• Press the Start button

The machine will start and work through the selected program automatically.

• Want to change your mind?

If you want to change program after you have started the machine, press Stop for 3 seconds. Then select a new program by pressing the appropriate symbol.

• If there should be a power failure

before the program has finished, the program will continue when power is restored.

If the power is turned off during drying, or the door is open for more than two minutes, during drying the program will be terminated.

• After washing

When the machine has stopped, it consumes only an extremely low power.

All the lights will come on to indicate the program has finished. They will go out when the door is open.

Indication lamps, see page 11

Start / Stop see page 8

How to save energy:

Wash only full loads

Save energy by not using the machine until it is full.

Wash at lower temperatures

You can lower the temperature in main wash and rinse in the Pots & Pans, Super and Normal wash programs to 130° F. In the Light wash program you can lower it to 120° F.

Is the machine connected to a cold water supply?

If the machine is connected to a cold water supply, running time will be longer, as the machine must heat the water. However, the longer washing time means that you can run the program at a lower temperature and still get the same wash performance. You also save electricity.

Select no drying

If you select no drying, the dishes will dry a little more slowly. You can speed up drying by opening the door a little to allow the moist air to escape.

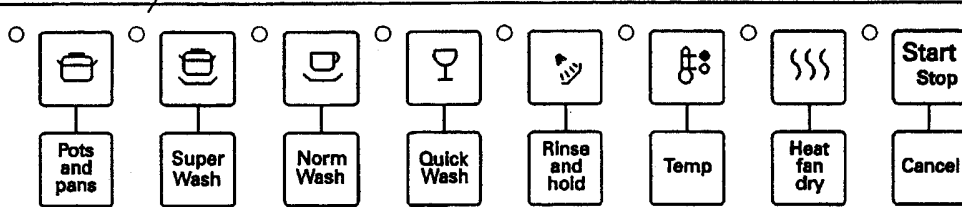

Dishwashing programs

Options, see page 8

Program features				Consumption figures	
=The dirty rinse water is emptied and the next period starts with clean water (SCS= Super Cleaning System)				Hot fill at 120°F	
Pre-wash	Main wash	RinSES	Drying	Cycle time, approx. min.**	Water consump. in gallons*
□ □ □ □	□ □ □ □ □ □ □ □	□ □ □ □ □ □ □ □	■	100	6.6
□ □ □ □	□ □ □ □ □ □ □ □	□ □ □ □ □ □ □ □	■	95	4.9
□ □ □ □	□ □ □ □ □ □ □ □	□ □ □ □ □ □ □ □	■	85	4.4
□ □ □ □	□ □ □ □ □ □ □ □	□ □ □ □ □ □ □ □	■	50	3.9
		□		4	.92

* For a dishwasher with water softener the figures are about 2 litres higher.

** The program times shown in the table are rounded-off values from actual tests. In practice, times may vary some-what due to the temperature of the water supply, voltage variations etc.

Rinse aid

This lamp lights to indicate that the machine has run out of rinse aid. After refilling, there may be some delay before the lamp goes out.



Start / Stop START

The program starts when you press this push-button.

Stop the program by holding the pushbutton de-pressed for three seconds. This is to prevent children playing with the pushbuttons and stopping the program.

You can also prevent children starting the machine by playing with the pushbuttons by programming the machine so that it will start only if the Start push-button is pressed and held for three seconds, see page 10.

NOTE:

When you select an option ( ), remember this:

- To activate and save an option, you must start a program. The reason for this is to prevent children playing with the pushbuttons and changing the temperature etc..

By re-programing (extra rinse etc.)

- The choice will remain till you change it. Even by stopping the machine with the main on/off button or if the machine by other reason has been out of power, all choices will remain, which were activated before the power failure.

- The choice will be shown for 2 seconds by the lamps. Then the machine will revert to the main program.

- A black filled symbol means a lit lamp. Lines over a lamp means that it is blinking.



Re-programings

Protected start program

You can also prevent children starting the machine by playing with the pushbuttons by programing the machine so that it will start only if the Start push-button is pressed and held for three seconds.

1. Press  5 times, which gets you into the protected start program.

2. Press  and you get protected start (3 sec)
or

Press  to revert to normal operation.

The indicating lamps show:



Do you want to change the rinse water temperature?

You can change the temperature in the last rinse water to 165° F in programs with 150 or 160° F main wash temperature.

1. Press  5 times within 15 seconds. Then you get into the changing program.

2. Press  and you get 165° F rinse water temperature.

or
Press  and you get the normal rinse temperature.





Do you want an extra rinse?

You can get an extra rinse in the programs



and  by doing like this:

1. Press  5 times within 15 seconds. Then you get into the changing program. The lamps show how many rinses the machine last gave.

2. Press  and you get an extra rinse.

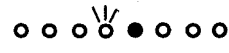

or
Press  and you get the normal number of rinses.

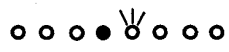





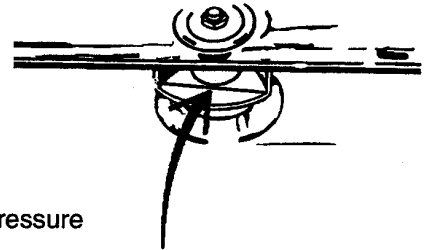







Too little water in the machine?

The water level is correct when it reaches up to the marking of the lower spray pipe bearing, see picture.

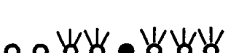

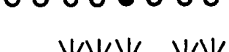
If there is insufficient water in the machine, it may be because the supply pressure is too low. This can be compensated for by altering the admission time.

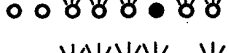





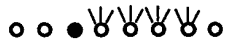

1. Press  five times within 15 seconds to get into the water level modification program.

2. Press		to get the normal inlet time		
		to get 25 % increase	75 seconds	
		to get 50 % increase	90 seconds	
		to get 100 % increase	120 seconds	
		to get 150 % increase	150 seconds	
		to get 200 % increase	180 seconds	

How to set the pumping out time

If you have a longer outlet hose or if there by other reason is a too short time for the machine to pump out the water, the pumping-out time can be changed. Do like this:

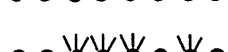
1. Press  5 times within 15 seconds. Then you get into the changing program.

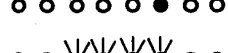
2. Press		to get an outlet time of	20 seconds	
Press		"	25	" Normal time 
Press		"	35	" 
Press		"	45	" 
Press		"	85	" 

The indicating lamps . . .



The indicating lamps serve several purposes: besides showing the selected program, they are also used if you need to trace a fault in the machine.

. . . display program contents

T indicating lamps show what a selected programme contains.

For Normal wash, for example, the following lamps would be lit:



. . . shows if anything is wrong

Indicates that the door is open when attempting to start a programme, or is opened while a programme is running.

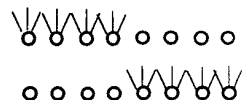

Indicates a fault in the heater.



Indicates high water level in the machine.



Indicates a thermistor fault (heater control).



Indicates a water inlet fault (just machines with water softener)



. . . assist fault-tracing

If the machine doesn't work properly, you can identify the reason. This allows you to describe the fault to service personnel and saves repair time.



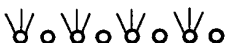



Start the fault-tracing program by pressing the  pushbutton 5 times within 15 seconds. These lamps will respond by flashing:



Marked symbol:

Tests:

If nothing is wrong, this happens:

	Water softener inlet valve	Water can be heard entering (only on machines with water softeners).
	Water inlet valve	Water can be heard entering.
	Detergent/Rinse aid solenoid (combi doser)	There will be a click, and detergent/rinse aid is coming out*.
	Heater	The element heats up. WARNING: Don't touch it!
	Circulation pump	The pump starts.
	Outlet pump	The pump starts.
	Fan motor	The fan starts and air is blowing out by the lower left corner of the door.

* If the detergent cover is closed, detergent will be dosed, or else rinse aid will be dosed.

Leave the test program by pressing

START

Care of the machine

The interior of the machine is manufactured from stainless steel, which is kept clean through normal use. It may, however, be necessary to clean the strainers and spray arms at intervals.

Fine filter

Food residues caught by the fine strainer are flushed away automatically each time the machine is used.

Unscrew the fine strainer sometimes and clean it with a brush.

When replacing the strainer, make sure that its edges seal properly against the bottom of the machine.

Outlet pump

You can reach the outlet pump from the inside of the machine. First remove the coarse strainer and the fine strainer.

Then you can remove a small cover in the bottom of the hole.

There you can reach the pump wing and remove eventual dirt. replace the cover and the strainers.

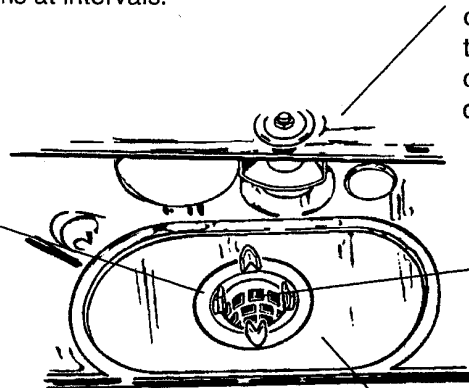

Spray arm jets and bearings

Pieces of dirt can block the spray arm jets or interfere with smooth running of the spray arm bearings. Undo the nut and lift off the washer on top of the spray arm so that the arm can be lifted off. Use a brush or suitable pointed object to get rid of any dirt.

Coarse strainer

The coarse strainer catches larger particles of food that would otherwise clog the outlet pump. Squeeze the lugs gently toward each other, lift out the strainer and clean it when necessary. Replace it in the reverse manner.

In the bottom the coarse strainer has openings, which let peas and macaronis out. Toothpicks, however, will stay in the strainer.

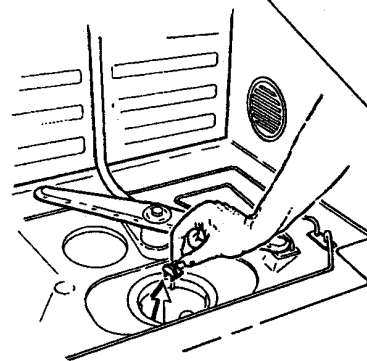

Filter

If the filter is dirty, it can be removed and rinsed clean. It can be removed by unscrewing the fine strainer and then simply pulling it straight upwards. Make sure that it clicks into position properly when you put it back.

Level indicator

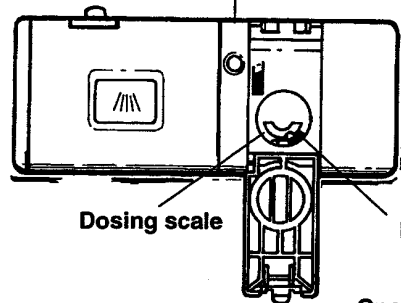

Dosing scale

Filling hole

Open by pressing the tab, then lift the lid.

Filling up with rinse aid

Drying will be faster if you use a rinse aid. The rinse aid indicating lamp on the panel flashes if the machine is out of rinse aid.* An indicator next to the rinse aid container shows whether it is empty. If the indicator appears completely black, there is sufficient rinse aid. If the size of the black spot is reduced, the container requires filling.

The first filling of rinse aid (Jet Dry) is included in the machine when it is delivered from the factory.

Adjusting rinse aid metering

Rinse aid is metered automatically: the setting is adjusted before the machine leaves the factory.

It may be necessary to alter the setting, to adjust the amount of rinse aid metered, depending on the hardness of the water supply. This can be done by opening the right cover. Then you can see the setting. This is normally set at 1. If the water in your area contains lime (over 10–12 °dH), an acid rinse aid (containing citric acid) should be used if the machine is not fitted with its own water softener. The metering setting should be adjusted to 1–6, depending on the hardness of the water.

Excessive use of the rinse aid can result in foam formation, particularly when the machine is connected to a cold water supply.

If the water in your area is very soft, you can dilute the concentrated rinse aid with an equal quantity of water.

Dishwashers with water softeners:

Note: Not all models have water softener

Topping up with salt

The salt container in machines fitted with water softeners must be pre-filled with water then salt before the machine is used for the first time. Use coarse salt or salt specially intended for use in dishwasher water softeners.

The indicating lamp on the panel flashes if the machine is out of salt. NOTE! After refilling with salt, it may take a while before the indicating lamp goes out.

If the indication does not function, the float under the cover may have got stuck in the salt residues. Push it upwards and downwards to loosen it.

Unscrew the cover of the salt container, as shown in the picture. Insert the funnel, supplied with the dishwasher, into the top of the salt container and fill with salt. Wipe off any spilled salt, so that the cover will seal properly, and replace the cover.

Any salt spilled in the machine must be rinsed away immediately. This can best be done by running a complete programme. For this reason, it is recommended that salt be filled into the machine just before using it to wash up.

Salt container cover

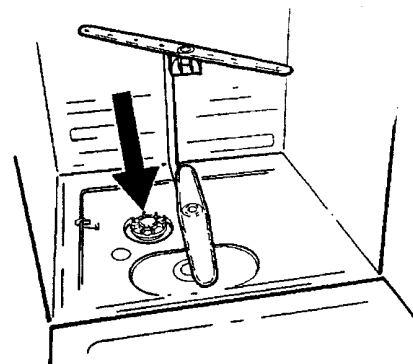









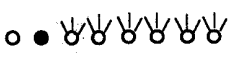

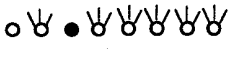

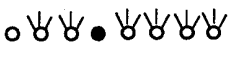
Adjusting the salt dispenser

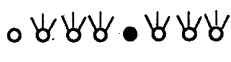
If the water in your area is very hard, it may be necessary to alter the amount of salt required.

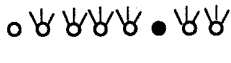
1. Press  5 times within 15 seconds. Then you get into the changing programme. The last programmed water hardness setting is showed by the lamps.

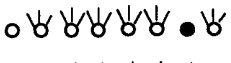
The indicating lamps show:

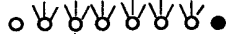
2.	Press		for a water hardness of	0-9 °dH	
	"		" " "	10-14 "	
	"		" " "	15-19 "	
	"		" " "	20-24 "	
	"		" " "	25-34 "	
	"		" " "	35-49 "	
	"		" " "	50-70 "	

The change will remain till a new change is made.

If no change is made within 2 seconds, the machine will revert to the main programme.

Safety

WARNING!
Wooden items and some plastics are a fire risk if they should fall on to the heating element.

Door switch

The machine has a door switch which turns off the power and stops the machine if the door should be opened while the machine is in use. The program will continue when the door is closed.

Note: If the door is open for more than 2 minutes during drying, the program will be terminated. The machine also has a child safety catch to prevent the door being opened.

Overfill protection

The machine incorporates an overfill protection device, which automatically starts the outlet pump and closes the inlet valve if the water level in the machine should rise to a higher level than normal. If the machine has overfilled, all lamps will be lit.

This protection operates only if the machine is switched on. It is therefore backed up by a further, mechanical protective device in the bottom of the machine. The bottom of the machine is made in the form of a tray, in which water from any leak will collect, lifting a float which electrically turns off the inlet valve and the circulation pump. It also starts the outlet pump. If this safety device has operated, turn off the water at the main supply tap and send for service.

Anti-tip guard

If the machine is installed completely free-standing, it must be fitted with an anti-tip guard.

Protected start procedure

In order to prevent children playing with the pushbuttons from starting the machine, you can program it so that the start pushbutton must be pressed and held for 3 seconds for the machine to start. See page 10.

Child safety catch

The machine incorporates a child safety catch, preventing small children from opening the door and being scalded by hot water or steam. The catch also prevents children from getting at the corrosive detergent.

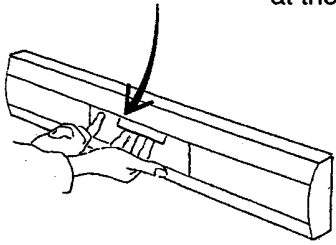

Engaged



To engage the child safety catch

Slide the catch to the left and turn the trace horizontal with a screwdriver. To open the door, hold the catch with your left hand and pull the main catch with your right hand in the usual way.

Disengaged



To disengage the child safety catch

Slide the catch to the left and turn the trace vertical with a screwdriver.

Poor dishwashing results

Before calling for service, try the following remedies:

Poor results may not always be caused by the machine. Read through the chart below before contacting your servicer.

Problem	Possible Cause	Suggested Remedy
Spotting and filming	Hard water	<p>Use the maximum recommended amount (3 tablespoons) dishwasher detergent. You may need a home water softener.</p> <p>To remove hard water spots, try a vinegar rinse:</p> <ul style="list-style-type: none"> • Wash and rinse load as usual. • Remove all metal items from dishwasher. • Do not add detergent. • Pour two cups of vinegar into a bowl and set it on the bottom rack of the dishwasher. • Run the dishes through an entire wash program. <p>If the vinegar rinse doesn't work, repeat the above process substituting 1/4 cup citric acid crystals (available at most drug stores) for the vinegar.</p> <p>Wiping with a damp cloth should remove spots from metal items. For sterling and silver plated flatware, rub with a towel, or use a good cream silver polish.</p>
	Filter system No rinse aid	<p>Check filter system to be sure it is clean and properly installed.</p> <p>Does the rinse aid dispenser need to be filled?(Note: Used only in hard water areas.)</p>
	Water not hot enough	<p>Use the Temp Boost for best results when washing heavily soiled or greasy items, except for fine china and delicate crystal.</p>
	Too little water	<p>Check that the water valve is fully open. Make sure that the water pressure is between 18 and 176 PSI.</p> <p>Check the filter in the inlet valve.</p>
	Dishwasher detergent	<p>Use only the correct amount of dishwasher detergent according to the hardness of the water and the wash program you have selected. Do not use old or caked detergent. Store the dishwasher detergent in a dry place and in a closed container. Change the dishwasher detergent, if the result is still unsatisfactory.</p>
	Items not loaded properly	<p>Check that you have loaded the items according to the instruction on pages 5 and 6. Do not overload. Make sure spray can reach all soiled surfaces.</p>
	Spray arms rotate poorly or stand still	<p>Check that both spray arms can rotate freely and that items do not obstruct the movement of the spray arms. Lift the arms and make sure that no grains of dirt etc. retard the rotation of the spray arms. If necessary, clear the obstruction, refit the arms and check that they rotate freely.</p> <p>Make sure that the holes in the spray arms are not blocked by dirt. If necessary, clear the holes with a pointed object.</p>
	Strainer blocked	<p>Check the strainer. Clean if necessary. See the instructions on page 13.</p>
	Excessive foam in the machine	<p>Use only dishwasher detergent. Too much rinse aid in final rinse cycle.</p>
	Flatware incorrectly loaded	<p>Pay particular attention to spoons so that they do not nest in each other and prevent water penetration.</p>
Small particles deposited on items	Spray arm or arms not rotating freely	<p>Be sure a utensil or handle has not prevented their turning.</p>
	Detergent	<p>Use only fresh detergent, stored in a tightly closed container in a cool dry place. Fill dispenser only when ready to start the dishwasher. Use the recommended amount of detergent, especially with hard water.</p>
	Low water pressure	<p>Check that the water valve is fully open. Make sure that the water pressure is between 18 and 176 PSI.</p>
	Improper loading of dishes	<p>Load dishes to prevent water and detergent from being trapped in or between items. Water should circulate freely.</p>

Marks and discoloration	Aluminum utensils rubbing against items during washing	Be sure aluminum utensils, especially light weight foil-type pans, do not touch dishes. To remove spots, use a non-abrasive cleaner.
Yellow or brown marks	Iron or manganese in water Copper with sterling silver Tea or coffee (tannic acid)	Temporary solution: Pour 1 teaspoon to 1 tablespoon of citric acid crystals in instead of the prewash detergent directly on the inside of the door. Follow this prewash with a full detergent wash. Use the heavy wash program. Permanent solution: Install an iron removal system in the water supply. Yellow film on sterling silver results when you wash copper utensils in the same load. Silver polish will usually remove this stain. Tea or coffee can stain cups. Remove stains by hand, using a solution of 1/2 cup bleach and 3 cups warm water. (Do not use on sterling silver or silver plate.)
Discoloration of stainless steel, silver plate or sterling silver	Allowing salty or acidic foods to remain on flatware Stainless steel contacting silver	Rinse flatware that is to stand several hours before washing. Do not put stainless steel and silver flatware in the same silverware basket compartment. Direct contact between these metals can cause permanent damage to silver. Clean stained items with silver polish. Do not use abrasives on stainless steel or silver.
Distortion of plastics	Plastic item has low heat tolerance	Plastics vary in their ability to tolerate heat. Check washing instructions for all plastic items to be sure they are dishwasher safe. If they are, place in top rack, away from the heating element.
Marks on melamine and plastics Cloudy film on glassware—etching of glass	Porous material Too much detergent, especially in soft water Rinse aid used with soft water	Use a special cleaner for plastic. DO NOT use bleach or scouring powder on these materials. If vinegar or citric acid rinse doesn't remove film, the cloudiness is "etching". This is permanent. To prevent etching, use the least amount (one teaspoon) of recommended dishwasher detergent if you have soft water. Use a good quality dishwasher detergent and rinse aid. Do not overload the machine. Water should circulate freely to assure adequate rinsing and draining. Use drying without heat. Use rinse aid in hard water areas only.
Dishes not dry	Non-heated drying No rinse aid Plastic items Improper loading or unloading Water not hot enough Dry cycle interrupted (Door opened too soon)	Be sure to select heated drying for the driest results. Allow more drying time when using non-heated drying. Fill rinse aid dispenser. Rinse aids help dishes to dry faster. (Note: Used only in hard water areas). Certain plastic materials are difficult to dry. Plastics may need towel drying. Do not overload or nest items. Be sure all surfaces drain well. Load items with concave bases so as much water as possible can run off. Unload the bottom rack first. Water from dishes in the top rack may be spilling into the bottom rack. Dishes washed with the HI water temperature setting will dry the fastest. If the door is opened during the heated dry cycle, the heating element does not come back on after the door is re-closed. Also, if dishwasher door is opened immediately after the dry cycle is completed and then shut again, the damper invent is closed, trapping warm humid air. It is best then to leave door open slightly.

Problem	Possible Cause	Suggested Remedy
Detergent left in detergent compartment (Detergent compartment will not open)	Compartment cover blocked Light cycle used Old detergent	The cover may not be opening because of improperly loaded items. Move dishes that may be blocking it. Detergent compartment door does not open during light cycle. Place detergent directly near bottom of inside surface of door. If detergent is hard or caked in the box, throw it away. Use only fresh detergent. Add detergent to dishwasher right before starting it.
Chipping or breaking of glassware	Improper loading	Do not overload. Load between prongs, not over them. Glasses loaded over prongs will not be supported and may chip or break. Make sure glassware is secure and can't come loose. Always use the top rack for delicate items. Use the delicate program for fine china.
Unusual noise	Improper loading	Utensils may not be secure or something small may have dropped from the rack. Water may cause utensils to rattle. Make sure everything is securely placed in the dishwasher.
Water left in bottom of dishwasher near filters	Dishwashing cycle not complete Some is normal	Allow dishwasher to complete cycle. Water left in removable coarse filter is normal.
Dishwasher will not drain	Air Gap Drain hose Filter system	Be sure air gap is not blocked or plugged. Check for kink in drain hose. Be sure there is no blockage in filter system. Remove, clean and place back in dishwasher before starting dishwasher.
Dishwasher will not start	Blown fuse or tripped circuit breaker Door not completely closed Plugged in incorrectly	Replace fuse or reset circuit breaker. Remove any other appliances from the circuit. Close tightly until you hear a click. Make sure plug-in contact is inserted in the wall socket or wired correctly.
Dishwasher will not fill	Door open Controls Water feed line Water supply	Check that door is firmly closed. Check that dishwasher is on. (See "Dishwasher will not start") Check to see that the water feed line to dishwasher is not crimped. Be sure water is available and turned on.
Water backs up in sink when dishwasher drains	Garbage disposer and trap	Check garbage disposer and trap at sink for blockage or food particles.



ASKO Product Warranty

MODEL 765, 775, 1355, 1475, 1555, 1655, 1895

For Residential Installations

Length of warranty	ASKO will pay for:
ONE YEAR FULL WARRANTY From date of purchase	ASKO replacement parts and/or repair labor to correct defect in materials or workmanship. Service must be provided by an authorized ASKO service outlet.
FIVE YEAR LIMITED WARRANTY One year full plus second through fifth year limited from date of purchase.	ASKO replacement parts (repair labor costs not included) for any defective solid state controls, timers, motors, pumps or dishwasher racks.
TWENTY-FIVE YEAR LIMITED WARRANTY One year full plus second through twenty-five year limited from date of purchase.	ASKO replacement parts (replacement labor cost not included) of the stainless steel tank or stainless steel inner door panel if it fails to hold water due to a manufacturing defect such as cracking or rusting.

For Non-Residential Installations

SIX MONTH FULL WARRANTY From date of purchase.	ASKO replacement parts and/or repair labor to correct defect in materials or workmanship. Service must be performed by an authorized ASKO service outlet.
----------------------------------------------------------	-----------------------------------------------------------------------------------------------------------------------------------------------------------

<p>ASKO will not pay for:</p> <p>A. Service calls to:</p> <ol style="list-style-type: none"> 1. Correct the installation of the dishwasher 2. Instruct how to use the dishwasher 3. Replace house fuses or correct house wiring 4. Correct house plumbing 5. Cleaning or servicing of air device in drain line <p>B. Repair and/or parts for failure of product if dishwasher is used in other than normal home use.</p> <p>C. Damage resulting from accident, fire, floods, acts of God, alteration, misuse abuse, improper installation or installation not in accordance with local electrical or plumbing codes.</p> <p>D. Any labor or shipping costs for parts during the limited warranty.</p> <p>E. Replacement parts or repair labor costs for units operated outside the Continental United States.</p> <p>F. Pick-up and delivery. ASKO dishwashers are designed to be repaired in the home.</p>

IN NO EVENT SHALL ASKO USA INC. BE RESPONSIBLE FOR ANY INCIDENTAL OR CONSEQUENTIAL DAMAGES.

Some states will not allow the exclusion or limitation of incidental or consequential damages, so this exclusion or limitation may not apply to you. This warranty gives you specific legal rights and you may also have other rights which vary from state to state.

For warranty service, contact the dealer from whom you purchased the unit or an authorized ASKO service outlet. Service will be provided during normal business hours. Should you have a service problem that is not resolved locally write:

ASKO USA INC.
P O Box 851805
Richardson, TX 75085-1805

Quick Guide

Do as follows

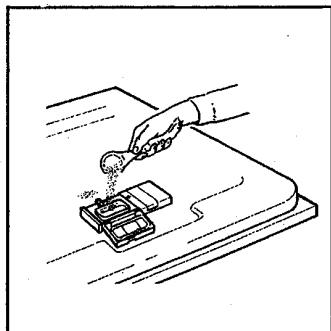

① Load the baskets and fill with detergent.

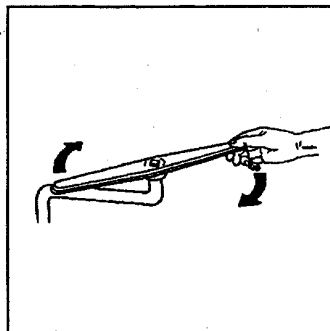

② Check that the spray arms can rotate freely ...

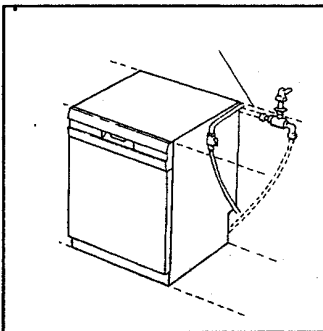

... and that the water is turned on.

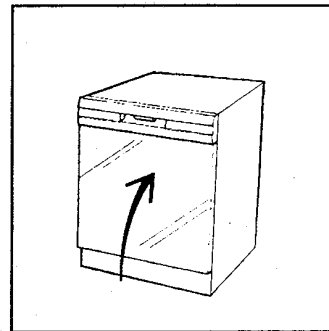

③ Close the door and select the program. Start the machine.

Choose the right program

Programs	Symbols
Pots & Pans	
Super Wash	
Normal wash	
Light wash	
Rinse & Hold	

To get best dish-washing performance, use Electrasol detergent and Jet Dry rinse aid.



It is not permitted to make any changes to the specifications of the machine without the written permission of the manufacturer.

We reserve the right to make changes.

Art nr 80 702 34