

This Owner's Manual is provided and hosted by [Appliance Factory Parts](#).



DE'LONGHI TCH7090ERM Owner's Manual

[Shop genuine replacement parts for DE'LONGHI
TCH7090ERM](#)



[Find Your DE'LONGHI Heater Parts - Select From 70 Models](#)

----- Manual continues below -----



DISHWASHER USE AND CARE GUIDE

IMPORTANT!
To get the best performance
from your dishwasher, read all
operating instructions before
using it for the first time.

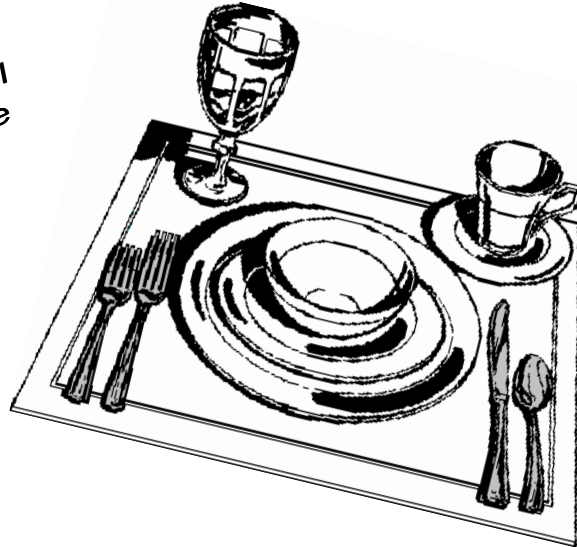

CONTENTS

Before Using Your New Dishwasher	2
Important Safety Instructions	2
Child Safety Tips	2
Dishwasher Features	3
Loading the Upper Basket	3
Knife/Utility Basket	3
Loading the Lower Basket	4
Loading the Silverware Basket	4
Detergent Dispenser	4
Amount of Detergent to Use	5
Rinse Aid Dispenser	5
Care and Cleaning	6
Overfill Protection	7
Energy Saving Tips	7
Solutions to Common Dishwashing Problems	8
Troubleshooting	9
Washing Special Items	10
Index	11
ASKO Product Warranty	12

SAVE THESE INSTRUCTIONS FOR FUTURE REFERENCE

BEFORE USING YOUR NEW DISHWASHER

- ◆ Read through this guide before attempting to use your new dishwasher.
- ◆ Read the "Washing Special Items" section before washing any porcelain or china that has "on-glaze" decoration, crystal glassware, or items of wood or plastic.
- ◆ Make sure the door is properly balanced. To do this, open it a little and release it. It should stay where you released it. If it doesn't, consult the *Installation Instructions* or contact your installer.
- ◆ Call your local water company to learn the water hardness in your area. You'll need to know this to determine how much detergent and rinse aid to use.

IMPORTANT SAFETY INSTRUCTIONS

This manual does not cover all possible conditions and situations that may occur. Some situations may arise where use of common sense and caution should always be used when installing, operating, and maintaining any appliance.

- ◆ Read all instructions before using the dishwasher.
- ◆ Dishwashers must be electrically grounded. Read the *Installation Instructions* for details.
- ◆ Use the dishwasher only for its intended purpose.
- ◆ Use only automatic dishwasher detergents and rinse agents.
- ◆ To reduce the risk of injury, keep detergents and rinse aids out of the reach of children.
- ◆ Do not load sharp items near the door; you could damage the door seal.
- ◆ Place sharp knives in the silverware basket with the sharp ends down to avoid the risk of cut-type injuries.
- ◆ Do not wash plastic items unless they are marked "dishwasher safe" or the equivalent. For items not marked, check the manufacturer's recommendations. Items not dishwasher safe could become deformed or melt and create a potential fire hazard.
- ◆ Do not touch the heating element during or immediately after use.
- ◆ Do not operate the dishwasher unless all enclosure panels are properly in place (i.e., guard plate, access panel, toe kick, etc.)
- ◆ Do not tamper with controls by removing or changing.
- ◆ Do not abuse, sit on, or stand on the dishwasher door or baskets .
- ◆ To reduce the risk of injury, do not allow children to play in or on a dishwasher.
- ◆ Under certain conditions, hydrogen gas may be produced in a hot water system that has not been used for two weeks or more. HYDROGEN GAS IS EXPLOSIVE. If the hot water system has not been used for two weeks, before using the dishwasher turn on all hot water faucets and let the water flow from each for several minutes. This will release any accumulated hydrogen gas. As the gas is flammable, do not smoke or use an open flame during this time.
- ◆ When removing an old dishwasher from service or discarding it, remove the door to the washing compartment.
- ◆ Do not store or use combustible materials, gasoline, or other flammable vapors and liquids in the vicinity of this or any other appliance.
- ◆ Disconnect electrical power to dishwasher before servicing.
- ◆ Repairs should be done by a qualified technician.

CHILD SAFETY TIPS

- ◆ Dishwasher detergents and rinse aids are corrosive, so always keep them out of reach of children.
- ◆ Should a child swallow dishwasher detergent or rinse aid, give plenty to drink immediately, i.e., one or two glasses of milk or water. Do not try to induce vomiting. Seek medical advice immediately: **1-800-POISON1**
- ◆ Always close the door and start the dishwasher as soon as you put in the detergent.
- ◆ Always keep small children away from the machine when it is open. There may be some detergent residue left inside the machine.
- ◆ If dishwasher detergent gets in someone's eyes, rinse them with plenty of water for at least 15 minutes.
- ◆ Do not allow children to use or play in or on the dishwasher.
- ◆ Load all long and sharp items in the knife/utensil basket. If this is not possible, load sharp objects with the pointed end facing the back of the dishwasher. Sharp items loaded in the silverware basket should be loaded with pointed ends down.
- ◆ Engage the child safety lock. (See below.)

ENGAGING THE CHILD SAFETY LOCK (MODELS 1375, 1385, 1485, 1595 AND 1885)

The child safety lock is located to the left of the door handle. To activate the lock, use a screwdriver to turn the screw slot to a horizontal position. Reset it by turning the slot to its vertical position.

To open the door when the safety lock is engaged, you must slide the lever to the left of the door latch toward the left and hold it as you lift the latch. (See illustration.)

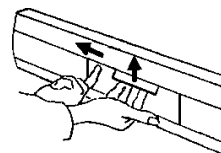

DISHWASHER FEATURES

Your new dishwasher features ASKO's Super Cleaning System™. This means that after the prewash, the water is drained out and the main wash starts with clean water. **If you plan to start your dishwasher right away, it's not**

necessary to rinse the dishes. You do, however, need to scrape off the large particles of food before loading.

NOTE: Deviations in features may occur, depending on the model.

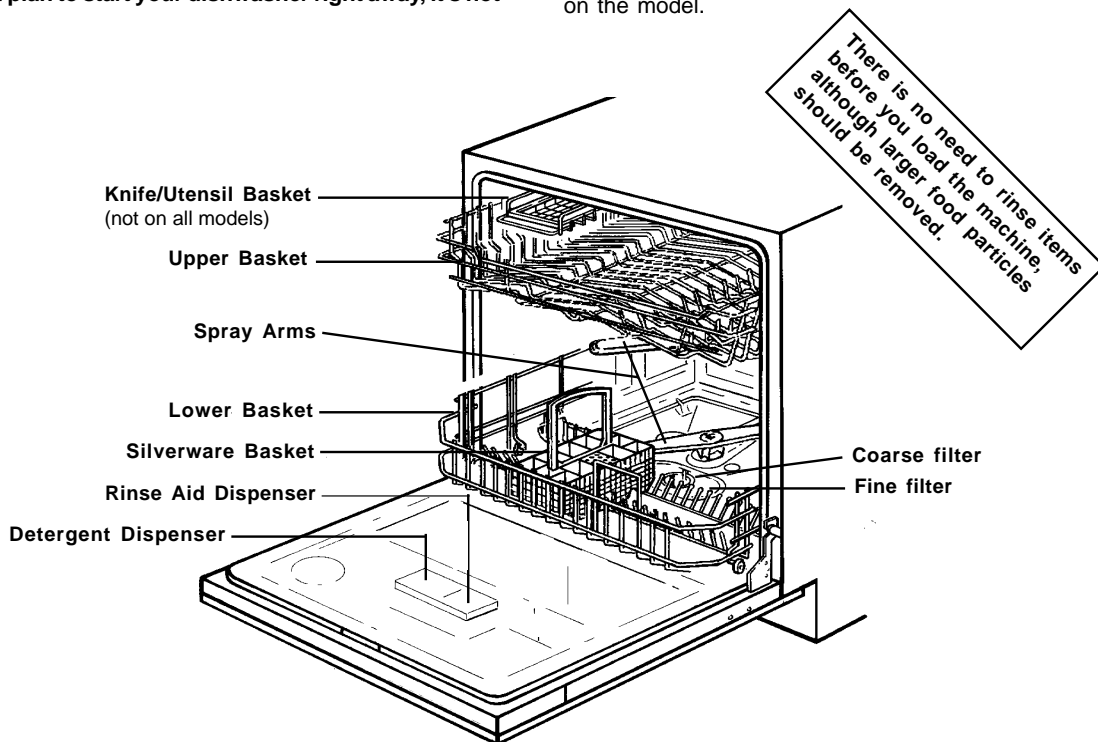

LOADING THE UPPER BASKET

After you have scraped off the large food particles, place glasses, cups, saucers, bowls and small plates in the upper basket, as illustrated. Load stemware with the stem fitted inside one of the grooved tines on the stemware rack.

The fold-down cup shelf on the right side of the basket gives you an additional place to stack cups and small bowls.

Some models have a knife stop on the front of the upper basket, just below the cup shelf. This gives you a place to load long utensils and knives that won't fit in the silverware or knife/utensil basket. The knife stop prevents knives or utensils from damaging the door when you open and close it. When loading sharp items, always be careful not to cut the rack coating.

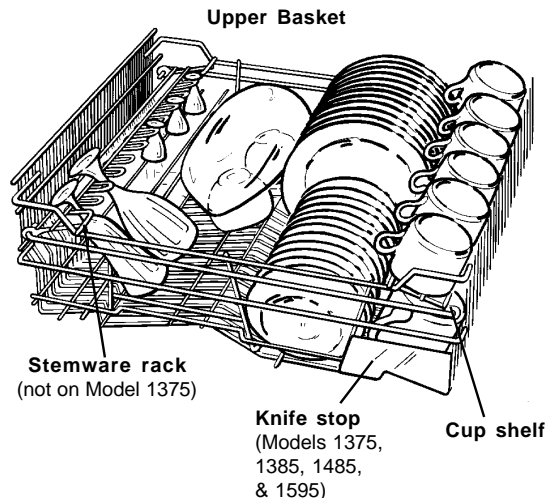

KNIFE/UTENSIL BASKET

Whenever possible, knives and long utensils should be loaded in the knife/utensil basket attached above the upper basket. To avoid injury, items with the sharp ends should *always* be loaded with the sharp ends pointed toward the back of the dishwasher. Again, always be careful not to cut the rack coating when loading sharp items.

Knife/Utensil Basket
(Models 1805, 1885 and 1895)

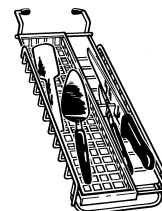

LOADING THE LOWER BASKET

Load larger items in the lower basket, such as, dinner plates, pots and pans, serving dishes, and casseroles. The removable plate rack easily lifts out to provide space

for large items, such as pots and pans. Be sure to load dishware facing downward or toward the center of the dishwasher.

Lower Basket

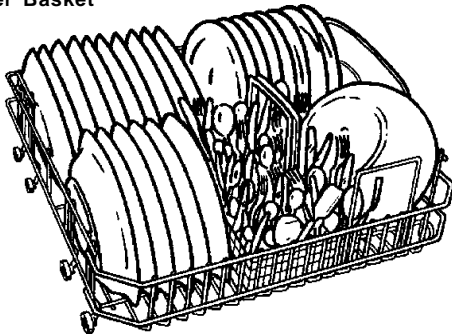

Removable Plate Rack
(not on all models)

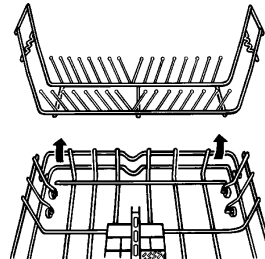

LOADING THE SILVERWARE BASKET

The silverware basket is designed with 17 compartments to help keep the silverware separated. Load silverware with the handles downwards and spread it out as much as possible to avoid nesting. For safety, load knives with the handles up.

Avoid placing silverware made of different materials (e.g., silver and stainless) in the same compartment because of the risk of discoloration. (See page 10.)

Small Items Containment Lid

The silverware basket has a lid in the middle that snaps down over the compartments to its left or right to contain small, lightweight items that might slip through the rack tines or get washed out of the basket and fall through onto the heating element. The small items lid is slotted, so you also could use it to keep silverware separated, such as teaspoons.

Silverware Basket

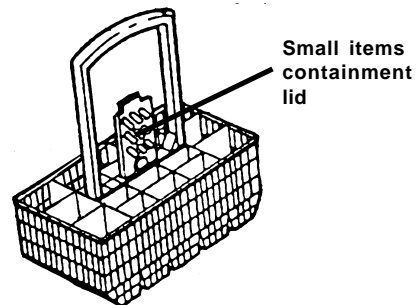

When loading silverware, try to avoid nesting the spoons and forks.

DETERGENT DISPENSER

ASKO dishwashers are designed to be energy efficient. Because the machine uses less water than conventional dishwashers, you also use less detergent and rinse aid. Generally, only one tablespoon of detergent is needed for a normal wash load. The amount of detergent needed for your dishes, however, could be more, depending on the hardness of the water in your area. Also, more heavily soiled items need more detergent. (See page 5.)

Measure and place detergent for the main wash into the large detergent compartment. The detergent for prewash goes into the small compartment to the right of the main wash compartment. You should use one-half the amount of detergent for the prewash that you use for the main wash. The amount of detergent used for the main wash and prewash combined should never be over three tablespoons.

Always add the detergent just before starting the dishwasher, otherwise it could get damp and won't dissolve properly.

Type of Detergent to Use

We recommend that you use only unscented, granular automatic dishwashing detergent. Using the wrong detergent could cause flooding and/or damage your dishwasher. Do not use detergent that has been wet and is clumped. Also, check the expiration date on the container.

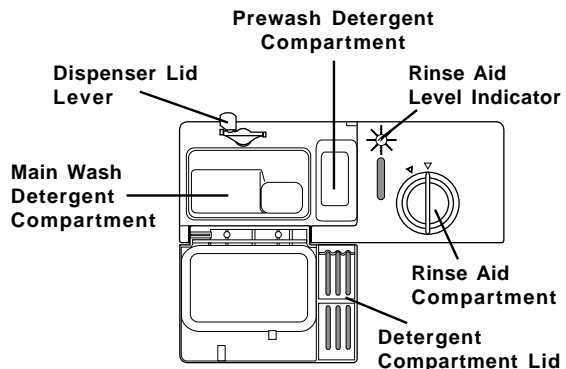

WARNING! Dishwasher detergent is corrosive! Take care to keep it out of reach of children.

AMOUNT OF DETERGENT TO USE

The amount of detergent needed can vary due to differences in water hardness. To determine the water hardness in your area, contact your local water utility or area water softening company. The harder the water, the more detergent you may need. Refer to the chart

below for the recommended detergent amounts based on water hardness. Remember, you should adjust the amount of detergent you use by small amounts until you find the correct amount.

RECOMMENDED DETERGENT AMOUNTS BASED ON WATER HARDNESS

WATER HARDNESS	DETERGENT AMOUNTS	
Soft (0-3 grains per gallon)	Prewash	1 teaspoon
	Main wash	1 to 1-1/2 tablespoons
Medium (4-8 grains per gallon)	Prewash	1 teaspoon
	Main wash	1 to 2 tablespoons
Hard (9+ grains*)	Prewash	1 teaspoons
	Main wash	2 to 3 tablespoons

NOTE: We recommend that you do not add prewash detergent for the Quick or Light wash programs.

* 12 grains and higher is extremely hard water and detergent alone may not be enough. You may need to use a water softener to maximize the performance of your dishwasher. Also, in areas with extremely hard water (9+) you may need to wash at lower temperatures to prevent hard water deposits from forming in tank and wash system.

In hard water areas, both the dishes and the machine can develop a white or gray film after a while. This can

be removed by replacing the prewash detergent with two tablespoons of citric acid. If the water is very hard, use a rinse aid that contains citric acid.

Different brands of dishwasher detergent have different amounts of phosphorous for softening water. If you have hard water and use a detergent with less than 8.7% phosphorous content, you may need to use more detergent or use a detergent with more than 8.7% phosphorous content.

REMOVING HARD WATER SPOTS FROM DISHES

To remove hard water spots, try the following:

1. Run dishes through a normal wash program.
2. Remove all metal dishware, such as cutlery, pans, etc., from the dishwasher.
3. Do not add detergent.

4. Pour two cups of vinegar into a bowl and set the bowl face up on the bottom rack of the dishwasher.
5. Run the dishes through a Normal wash program.

If this doesn't work, try the same process with 1/4 cup of citric acid crystals (available at most drug stores) instead of vinegar.

RINSE AID DISPENSER

The rinse aid is released during the final rinse to prevent water from forming droplets on your dishes that can leave spots and streaks. It also improves drying by allowing water to "sheet" off the dishes.

ASKO dishwashers are designed to use liquid rinse aids. The rinse aid dispenser is located inside the door next to the detergent dispenser. (See illustration on page 4.) To fill the dispenser, open the cap and pour the rinse aid into the dispenser until the level indicator turns completely black. The dispenser holds about four ounces of liquid rinse aid.

Be careful not to overfill the dispenser, because this could cause oversudsing. Wipe away any spills with a damp cloth. Don't forget to replace the cap before you close the dishwasher door.

If you have soft water, rinse aid may cause a white film to develop on your dishes. You may not need rinse aid.

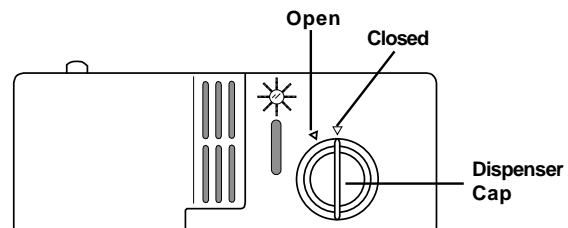

1. To open the dispenser, turn the cap to the "open" (left) arrow and lift it out.
2. Pour the rinse aid into the dispenser, being careful not to overfill.
3. Replace the cap by inserting it aligned with "open" arrow and turning it to the closed (right) arrow.

ADJUSTING THE AMOUNT OF RINSE AID DISPENSED

A measured amount of rinse aid is released during the final rinse. As with detergent, the amount of rinse aid needed for your dishes depends on the hardness of the water in your area. (See page 5.) Too much rinse aid can result in lather or foaming and cause cloudiness or streaks on your dishes. If the water in your area is very soft, you may not need rinse aid. If you do, you can dilute the rinse aid with an equal amount of water.

The rinse aid dispenser has six settings. Always start with the dispenser set on "1." If spots and poor drying are problems, increase the amount of rinse aid dispensed by removing the dispenser lid and rotating the dial to "2." If the dishes still aren't drying properly or are spotted, adjust the dial to the next higher number until your dishes are spot-free.

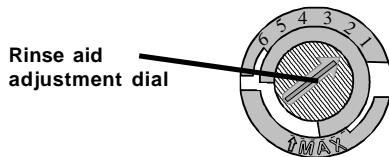

To increase the amount of rinse aid released in the final rinse, turn the adjustment dial to the next higher number.

NOTE: Only adjust the dial one number at a time.

WHEN TO REFILL THE RINSE AID DISPENSER

The black dot on the rinse aid dispenser indicates the amount of rinse aid in the dispenser. As the rinse aid diminishes, the size of the black dot decreases. You should never let the rinse aid get below 1/4 full.

As the rinse aid diminishes, the size of the black dot on the rinse aid level indicator changes, as illustrated below.

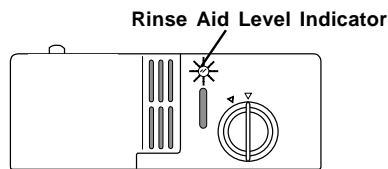

- Full
- 3/4 full
- 1/2 full
- 1/4 full - Should refill to eliminate spotting
- Empty

RINSE AID INDICATOR LIGHT

Models 1805, 1805FI, 1805 HNDL, 1885, and 1895 have a rinse aid indicator light on the control panel that comes on when the dispenser is empty. After you refill the dispenser, there may be some delay before this light goes out.

- — Some models have a rinse aid indicator light on the control panel that lights up when the dispenser is almost empty.

CARE AND CLEANING

The interior of your ASKO dishwasher is made of surgical quality stainless steel that has been electro-polished to make it the smoothest surface available. The smooth surface prohibits the accumulation of dirt and bacteria inside the unit. If the water in your area is especially hard, however, lime deposits could form

inside the machine. If this happens, you can remove them by putting two tablespoons of citric acid in the detergent compartment and running a Normal program. In extremely hard water areas you may need to repeat this process a few times to remove hard water deposits.

FILTERING SYSTEM

For your convenience, we have placed the drain pump and filtering system within easy reach inside the tub. There are three components of the filtering system: the main filter, the coarse filter, and the fine filter.

Main filter

Food and soil particles trapped by this filter are pulverized by a special jet on the lower spray arm and washed down the drain.

Coarse filter

Larger items, such as pieces of bone or glass, that could clog the drain are trapped in the coarse filter. To remove an item caught in this filter, gently squeeze the tabs on top of this filter and lift it out.

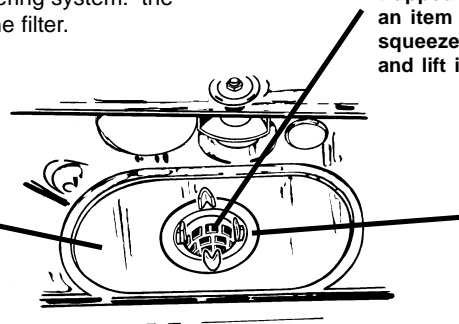

Fine filter

This filter holds soil and food residue in the sump area and prevents it from being redeposited on the dishes during a cycle.

WARNING! Never run the dishwasher without the filters in place.

CLEANING THE FILTERS

In hard water areas, it may be necessary to clean chemical buildup from the filters every 12 to 18 months. To do this, remove the coarse filter by squeezing the

tabs and lifting it out. Next, unscrew the fine filter and lift it and the main filter out. Wash all three filters gently in hot, soapy water and rinse them thoroughly.

CLEANING THE DOOR

To clean the edge around the door, use only a soft warm, damp rag. To prevent penetration of water into the door lock and electrical components, **do not use a spray cleaner of any kind.**

Also, never use abrasive cleaners or scouring pads on the outer surfaces because they will scratch the finish. Some paper towels can also scratch or leave marks on the surface.

WARNING!

Never use a spray cleaner of any kind on the door panel. You could damage the door lock and electrical components. And never use abrasive cleaners or scouring pads on the outer surfaces because they will scratch the finish. Also, some paper towels can scratch or leave marks on the stainless steel surface.

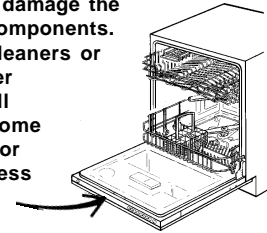

CLEANING THE SPRAY ARMS

Spray-arm jets and bearings may sometimes become clogged with hard water chemicals. To remove the spray arms, screw off the nut and take off the washer on top of

the spray arm and lift off the arm. Wash the spray arms in warm, soapy water. Use a soft brush to clean the jets. **Rinse thoroughly** and replace.

CLEANING THE DRAIN PUMP

On occasion something may get through the filters and into the drain pump. The drain pumps on ASKO dishwashers are designed to automatically reverse if anything should get caught in the propellers, thus ejecting the item back into the sump area or down the drain. Should you need to remove an obstacle from the drain, first turn the power off then remove the filters (as explained on page 6). Next, lift out the small black insert from the sump area. (You might want to remove any standing water first.) You can then look into the sump area for the item causing the obstruction. Should you find something, simply scoop it out. Be sure to replace the black insert before you put the filters back in.

To reach an item caught in the drain pump, remove the filters then the small black insert in the sump area.

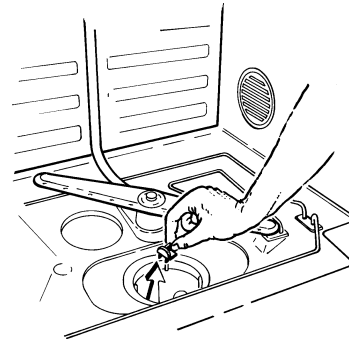

WARNING!

Never run the dishwasher without the filters in place.

OVERFILL PROTECTION

Your ASKO dishwasher has an overflow protection device that automatically shuts off the inlet valve and starts the drain pump if the water level in the unit should rise above the normal level. If this happens, turn the water off at the main supply and call for service.

If there is water in the base pan due to an overflow or small leak, the water must be removed before the dishwasher will start.

OVERFILL PROTECTION ON OUR ELECTRONIC MODELS

On Models 1485, 1595, 1805, 1885, and 1895, when an overflow is detected all of the indicator lights on the control panel will flash at once.

On Models 1485, 1595, 1885 and 1895, the LED window will also display a fault code (F2).

ENERGY SAVING TIPS

- ◆ If you plan to wash the dishes right away, there's no need to pre-rinse. Simply scrape off large particles and load the dishes.
- ◆ Wash only full loads.
- ◆ Use the Pan program only for heavily soiled dishes.

- ◆ Don't use the Temp boost for lightly soiled dishes.
- ◆ Avoid using Heat dry. (You can speed up the drying process by opening the door slightly to release the moist air.)

SOLUTIONS TO COMMON DISHWASHING PROBLEMS

As with any new appliance, it sometimes takes using it a few times to learn to operate it properly. If you are having minor performance problems with your dishwasher, read

this section before calling for service. It may save you time and unnecessary expense.

Poor washing performance

- ◆ The dishes may not be loaded properly. Make sure that soiled surfaces are facing downward or toward the center of the dishwasher. Also, make sure that the bowls, pots, etc., are not stacked so closely that water can't reach the soiled surfaces.
- ◆ Make sure you are using the appropriate program settings for the dirtiness of your dishes.
- ◆ An item may be obstructing the spray arm rotation. With the baskets loaded and in place, manually turn the spray arms to make sure they move freely.
- ◆ Your dishwasher detergent should be fresh and stored tightly closed in a cool, dry place. Old or caked detergent will not dissolve properly. Wait until you are ready to start the dishwasher to add the detergent. If you are using the Delay program, make sure the dispenser is dry before adding the detergent.
- ◆ Your dishwasher detergent may be inferior. Try a different brand.
- ◆ Make sure the rinse aid dispenser is filled. (See pages 5 and 6.)
- ◆ If you have hard water in your area, try adding more detergent and increasing the amount of rinse aid dispensed. (See page 5.)
- ◆ Check that the spray arm jets are not clogged. (See page 7.)

Poor drying performance

- ◆ Select the Heat Dry option.
- ◆ If you don't want to use Heat Dry, you can decrease the drying time by opening the door slightly to let out the warm, humid air.
- ◆ Make sure the rinse aid dispenser is filled. (See page 6.)
- ◆ Make sure you use the proper amount of rinse aid. (See page 6.)
- ◆ Do not overload the dishes and be careful to avoid nesting.
- ◆ Load items with concave bottoms tilted so as much water as possible will run off.
- ◆ Unload the bottom basket first to avoid spilling water onto the dishes when unloading the top basket.
- ◆ Dishes washed in higher water temperatures will dry faster.
- ◆ Certain plastics may need to be towel dried.

Plastic Items

- ◆ Always check the manufacturer's suggested care instructions before washing plastic in your dishwasher. Even dishwasher-safe items should be loaded in the top basket, away from the heating element.
- ◆ Some high-acid foods can discolor plastic. You should rinse these items if you do not plan to run the dishwasher right away.
- ◆ Plastic items dry poorly and may need to be towel dried.

Chipped or Broken Dishes

- ◆ When you load the dishes, be sure they're securely in place and will not fall over or strike against each other during the wash.
- ◆ Load glasses between the tines, not straddling them.
- ◆ Move the baskets in and out slowly to avoid slamming the dishes together.
- ◆ Make sure not to load dishes so high that the spray arms could strike them.
- ◆ Make sure tall glasses and stemware will clear the top of the tub when you push the basket in.
- ◆ Always load delicate items in the top basket.
- ◆ Do not overload the dishwasher.
- ◆ Do not jam the glasses together when loading.

Stains and discolorations

Stains or discoloration on dishes could be caused by a number of things. Listed below are some of the most common causes. See also "Washing Special Items" on page 10.

- ◆ Too much iron or manganese in the water can cause yellow or brown marks on your dishes. As a temporary solution, in place of the prewash detergent, use one teaspoon to one tablespoon of citric acid crystals. You should consider installing a water filtering system.
- ◆ Coffee and tea stains usually have to be removed by handwashing in a solution of 1/2 cup bleach and one quart of water. (Do not use on sterling silver or silver plate.) Be sure to rinse these items thoroughly before putting them in the dishwasher so there is no bleach residue on the dishware.

Etching

If you have a cloudy film on your dishes that can't be removed, it could be etching. To prevent etching, try the following:

- ◆ Use less detergent. You may be using too much for the water hardness in your area. (See page 5.)
- ◆ Use a good quality dishwasher detergent.
- ◆ Do not overload the machine. Water should circulate freely to ensure adequate rinsing and draining.
- ◆ Fill the rinse aid dispenser (unless you have soft water in your area; in which case you may not need a rinse aid.) (See page 5.)
- ◆ Use a lower water temperature setting.
- ◆ Do not use the Heat Dry option.
- ◆ Do not pre-rinse the dishes; just scrape off large food particles and bones.

TROUBLESHOOTING

If you should experience a problem with your dishwasher, you should review the following list of frequently encountered situations. It could save you the cost and inconvenience of a service call.

Even though the product is under warranty, if the problem

is not caused by defective product workmanship or materials, you will be charged for a service call. Refer to page 12 to determine what is and is not covered under your warranty. If you're still not sure, contact the ASKO Advisory Center before you call a service technician.

Detergent left in compartment

- ◆ Be careful not to load items so close to the dispenser that the cover will not open to release the detergent.
- ◆ The dispenser is not supposed to open when you use the Rinse program.
- ◆ Your dishwasher detergent should be fresh and stored tightly closed in a cool, dry place. Old or caked detergent should be thrown away because it will not dissolve properly and will leave a gritty residue on the dishware.
- ◆ Wait until you are ready to start the dishwasher to add the detergent.
- ◆ If you are using the Delay program, make sure the dispenser is dry before adding the detergent.
- ◆ The detergent compartment only opens in the main wash programs, not the Rinse program.

Dishwasher makes unusual noises

- ◆ This usually means that something is not loaded properly. Make sure the dishes are securely in place and that nothing has fallen between the basket tines. Also, place small items in the small items compartment and close the lid. (See page 4.)

Dishwasher leaks

- ◆ Use only unscented, granular automatic dishwasher detergent. Using a liquid detergent could cause oversudsing and leakage.
- ◆ You should always use fresh detergent.
- ◆ The amount of detergent needed for your dishes depends on the hardness of the water in your area. Contact your local utility company to learn the water hardness in your area then refer to the chart on page 5 to determine the amount of detergent you should use.
- ◆ Be careful not to overfill the rinse aid dispenser. Spilled rinse aid could cause oversudsing and lead to overflowing. Wipe away any spills with a damp cloth.
- ◆ Make sure the dishwasher is level. (See the installation instructions.)

Dishwasher runs too long

- ◆ If the temperature of the water entering your dishwasher is below 120°, the dishwasher runs longer because it heats the water to the proper temperature for the program selected. Raising your water heater setting may help to shorten the cycle times. If this doesn't resolve the problem, call the ASKO Advisory Center.

Dishwasher does not drain properly

- ◆ Make sure that the cycle was complete before you opened the dishwasher. If not, allow it to complete and check again.
- ◆ Some water left in the sump area near the drain is normal.
- ◆ If the plumbing code in your area requires an air gap, make sure that the air gap isn't blocked or plugged.
- ◆ If the unit is connected to a garbage disposer, make sure the disposer is empty.
- ◆ If water backs up into the sink, check the garbage disposer and trap for blockage.
- ◆ Check the dishwasher filters and drain area for blockage. (See pages 6 and 7.)
- ◆ Check for a kink in the drain hose.
- ◆ You may need to adjust the drain time to accommodate longer drain lines, air gaps, etc. (Call the Advisory Center.)

Dishwasher does not fill properly

- ◆ Make sure the water supply is turned on.
- ◆ Make sure the dishwasher is turned on and the door is closed securely.
- ◆ Check for crimps in the water feed line.
- ◆ You may need to adjust the water inlet time to compensate for low water pressure in your area. (Call the Advisory Center.)
- ◆ The system is designed to detect an overflow. When it does, it shuts off the circulation pump and turns on the drain pump. (See "Overfill Protection" on page 7.)

Dishwasher will not start

- ◆ Make sure the dishwasher is turned on and the door is closed securely.
- ◆ Make sure the Delay option is not turned on.
- ◆ Check that the water supply is connected properly and the water is turned on.
- ◆ Make sure the power cord is properly plugged into the wall socket.
- ◆ Check your fuse box for a blown fuse or tripped circuit breaker.

WASHING SPECIAL ITEMS

Most common dishware items can be safely washed in an automatic dishwasher. If you have any doubts about a particular item, check with the manufacturer to see if it is dishwasher safe. If that isn't possible, you might wash one item of a set a few times and compare it to the rest of the set to determine if washing it in the dishwasher

had any affect on it.

NOTE: ASKO has no control over what is put in our dishwashers once installed in a customer's home. **You are solely responsible for what you wash in your ASKO dishwasher.**

Material	Dishwasher Safe	Information and Recommendations
Aluminum	Yes, with caution	Anodized aluminum may fade or darken. Patches and discoloration may appear, but they can be removed with steel wool. Load aluminum utensils (such as a pie tin or roasting pan) where they do not touch other dishes because this can cause gray or black marks. You can remove these spots with a nonabrasive cleaner.
Cast Iron	No	The seasoning is lost and the iron rusts. Hand wash and dry immediately.
China	Yes, with caution	China without decoration or with decoration protected by glaze is dishwasher safe. However, you should arrange the objects so they do not touch each other or they could be damaged. China with a pattern on top of the glaze or with gold leaf decoration may fade. If possible, check with the manufacturer. If that isn't possible, wash one item over an extended period then compare it with the colors and patterns of the rest of the set. Wash in the Quick program on a low temperature setting.
Copper	Yes, with caution	Do not wash copper in the same load as silver or silver plate. It could discolor the silver items. Do not let copper items come in contact with stainless steel.
Crystal	No Yes	Antiques and very delicate china should not be washed in the dishwasher. Certain types of lead crystal may etch if machine washed. Check with the manufacturer. Wash at a low temperature setting. Be sure to load crystal dishware so that it is secure and will not fall over or knock against other dishware while being washed.
Dirilyte	No	Gold-colored flatware can become discolored.
Disposable plastic items	No	Cannot withstand machine washing.
Flatware with bonded handles	No	Certain types of adhesives may loosen when machine washed.
Glass	Yes	<i>Exception:</i> Milk glass may turn yellow.
Knives	No	Sharp kitchen knives may become dull if washed in very hot water and allowed to contact other items during the wash. Wood handles may also warp, crack, or loosen. Plastic handles may discolor. Check manufacturer's washing instructions.
Lead crystal	No	Certain types of lead crystal may etch if machine washed.
Non-dishware items	No	Never wash items such as electronic air cleaners, air filters of any kind, paint brushes, etc. You could damage the dishwasher.
Non-stick coatings	Yes	If marked "Dishwasher Safe." After washing, wipe the non-stick coating area with vegetable oil to maintain its non-stick quality.
Pewter	No	Pewter will tarnish when machine washed.
Plastic	Yes	If the item is labeled "Dishwasher Safe." Otherwise, check with the manufacturer. Always load plastic in the top basket. Do not use Heat dry. Do not wash disposable plastic items.
Silver and Silver plate	Yes, with caution	Rinse these items if you're not going to wash them immediately; salty or acidic foods can stain if left on. Dry dishwasher detergent can produce black marks which are difficult to remove. Do not put silver and silver plate in the same silverware basket with stainless steel. Contact between these metals can damage silver. Do not wash copper utensils in the same load. This could cause a brown film on the silver. Also, adhesives used to attach some hollow-handled knives can loosen.
Stainless Steel	Yes, with caution	Rinse these items if you're not going to wash them immediately; salty or acidic foods can stain if left on. Dry dishwasher detergent can produce black marks which are difficult to remove. Do not mix different types of stainless steel in the same load.
Tin	No	Tin will rust.
Wood	No	Unless marked "Dishwasher Safe" by the manufacturer. Wood can warp, crack or lose shape with any kind of washing.

INDEX

A	
Advisory Center Number	9
Aluminum, washing	10
C	
Care and cleaning	6
Cast iron, washing	10
Child safety tips	2
China, washing	10
Chipped or broken dishes	8
Cleaning the filters	7
Coarse filter	3, 6
Common dishwashing problems	8
Copper, washing	10
Crystal, washing	10
Cup shelf	3
D	
Detergent	
amount to use	5
dispenser	4
left in compartment	9
Dirilyte	10
Dishwasher features	3
Dishwashing problems	8
Disposable plastic, washing	10
Door, cleaning	7
Drain problems	10
Drain pump, cleaning	7
E	
Energy saving tips	7
Etching	8
F	
Fill problems	9
Filtering system	6
Fine filter	3, 6
Flatware with bonded handles	10
G	
Glass, washing	10
H	
Hard water	5
K	
Knife stop	3
Knife/Utensil basket	3
Knives, washing	10
L	
Lead crystal, washing	10
Loading	
upper basket	3
lower basket	4
M	
Main filter	6
Main wash detergent compartment	4
N	
Noises, unusual	9
Non-dishware items, washing	10
Non-stick coatings, washing	10
O	
Overfill protection	7
P	
Pewter, washing	10
Plastic items, washing	8, 10
Poor performance problems	8
Prewash detergent compartment	4
R	
Rinse aid dispenser	5
filling	5
adjusting amount dispensed	6
Rinse aid indicator light	6
Rinse aid level indicator	4, 6
Runs too long	9
S	
Safety instructions	2
Service	12
Silver, washing	10
Silver plate, washing	10
Silverware basket, loading	4
Small items compartment	4
Solutions to problems	8, 9
Spray arms, cleaning	7
Stainless steel, washing	10
Stains and discolorations	8
Stemware rack	3
T	
Tin items, washing	10
Troubleshooting	9
U	
Unusual noises	9
Upper basket	3
Utensil/knife basket	3
W	
Warranty information	12
Washing special items	10
Water hardness	5
Wood items, washing	10

ASKO PRODUCT WARRANTY

MODELS 1375, 1385, 1485, 1595, 1805, 1805FI, 1805 HNDL, 1885, 1895

FOR RESIDENTIAL INSTALLATIONS

LENGTH OF WARRANTY	ASKO WILL PAY FOR
One-Year Full Warranty From date of purchase.	ASKO replacement parts and/or repair labor to correct defect in materials or workmanship. Service must be provided by an authorized ASKO service outlet.
Five-Year Limited Warranty One year full plus second through fifth year limited from date of purchase.	ASKO replacement parts (repair labor costs not included) for any defective solid state controls, timers, motors, pumps or dishwasher racks.
Twenty-Five Year Limited Warranty One year full plus second through twenty-fifth year limited from date of purchase.	ASKO replacement parts (replacement labor cost not included) of the stainless steel tank or stainless steel inner door panel if it fails to hold water due to a manufacturing defect, such as racking or rusting.

FOR NON-RESIDENTIAL INSTALLATIONS

Six-Month Full Warranty From date of purchase.	ASKO replacement parts and/or repair labor to correct defect in materials or workmanship. Service must be performed by an authorized ASKO service outlet.
--	---

ASKO WILL NOT PAY FOR:

- A. Service calls to:
 - 1. Correct the installation of the dishwasher
 - 2. Instruct how to use the dishwasher
 - 3. Replace house fuses or correct house wiring
 - 4. Correct house plumbing
 - 5. Cleaning or servicing of air device in drain line
- B. Repair and/or parts for failure of product if dishwasher is used in other than normal home use.
- C. Damage resulting from accident, fire, floods, acts of God, alteration, misuse, abuse, improper installation, or installation not in accordance with local electrical or plumbing codes.
- D. Any labor or shipping costs for parts during the limited warranty.
- E. Replacement parts or repair labor costs for units operated outside the Continental United States.
- F. Pickup and delivery. ASKO dishwashers are designed to be repaired in the home.

IN NO EVENT SHALL ASKO USA INC. BE RESPONSIBLE FOR ANY INCIDENTAL OR CONSEQUENTIAL DAMAGES.

Some states will not allow the exclusion or limitation of incidental or consequential damages, so this exclusion or limitation may not apply to you. This warranty gives you specific legal rights and you may also have other rights which vary from state to state.

For warranty service, contact the dealer from whom you purchased the unit or an authorized ASKO service outlet. Service will be provided during normal business hours. Should you have a service problem that can not be resolved locally write:

ASKO USA Inc.
P. O. Box 851805
Richardson, Texas 75085-1805
or call our
Advisory Center at 972-238-0794