

This Owner's Manual is provided and hosted by [Appliance Factory Parts](#).



ASKO D3250GR Owner's Manual

[Shop genuine replacement parts for ASKO D3250GR](#)



[Find Your ASKO Dishwasher Parts - Select From 210 Models](#)

----- Manual continues below -----

Use & Care Guide

Dishwasher

ASKO D3250

Dear ASKO-customer;

Congratulations on your excellent product choice and welcome to the Asko family. A global family with its roots in Scandinavia.

Cleaning results, design, environmental impact on nature and home, user-friendliness, low consumption of time, energy and water; a long life span, reliability... Good appliances should include all of these. And this is what we try to give you.

When you buy an ASKO product, we want you to feel assured that the inside is as good as the outside and that the ethics and morals on which we built this machine are just as high as the quality and performance you get from it. That is what Scandinavian quality is all about.

In order to get the best possible results from your machine and all its functions, please read this Use and Care Guide before using the machine for the first time. And if you have any questions, please do not hesitate to call us or contact us via our web site.

Best regards from Scandinavia and the people at Asko.

Contents

Contents	Page 3-4	Options	13
Before doing your first wash	5	Upper/ Lower basket	
Read the directions of use		Temperature	
Take care with certain materials		Delayed start	
Check the door		Drying	
Check water hardness level		Express	
Machines with water softener		Press start	
Safety	6	Changing options	
General		Do you want to load more dishes?	
Winter storage/Transport		If the machine is switched off at	
Overfill protection		the main switch	
Cleaning		After dishwashing	
Packaging materials		Eco-dishwashing	14
Scrapping		Only perform washes with a full machine	
Child safety	7	Wash at a lower temperature	
Child-safe button lock		Select program with Eco drying	
Child-safe dishwashing		Do not rinse before dishwashing	
Protect your children! Dishwasher detergent		Choose environmentally-friendly	
is corrosive		dishwasher detergent	
Parts of the dishwasher	8	Connect to cold water supply	
Technical information	8	Fragile dishes	15
Baskets	9	Fragile decoration	
Control panel	10	Crystal/ glass	
Dispenser	10	Silver	
Basic Course	11-13	Cutlery with glued handles	
Load the baskets correctly		Wood	
Dispensing dishwasher detergent		Aluminium	
Selecting programs		Plastic	
		Protect plastic goods	
		Standard program	16
		Cleaning	18-19
		Coarse filter	
		Fine filter	
		Drain pump	
		Spray arms	
		Door	





Rinse aid	20	Adjusting the plinth (Only if you have a kick-plate as an accessory) Screw the dishwasher into place
Pour in rinse aid Select dosage		
Salt	21	Fitting fixed kick-plate
Pour in salt		
Settings	22-25	Fitting strip seal (on floor plinth covering plate) NB! Not all models
Reprogramming		
Child-safe button lock		
Super rinse		
Setting water hardness		Setting water hardness
Setting a signal		
Fault indications	26	Service & guarantee 36
Troubleshooting	27-29	Own comments 37-38
The dishes are not clean		Search words 39
Stains or a film on the china		Quick Guide 40
The china has a whitish-blue sticky film		
Stains on stainless steel or silver		
Stains which remain after dishwashing.		
Rattling sounds during dishwashing		
The machine will not start		
Water remains in the machine		
Bad odour in the machine		
Overfilling/leakage		
Performance information	30	
Installation	31-35	
Suggestions on positioning the dishwasher		
A. Built-in		
B. Freestanding		
C. Semi-freestanding		
Connection to water supply		
Connection to electricity		
Connection to drainage		
Positioning the machine		
A. Adjusting machines with six feet (freestanding dishwasher)		
B. Adjusting machines with three or four feet		
C. Adjusting machines with adjustable foot		

Before doing your first wash

Read through the directions for use

Read the directions of use before starting to use your machine, especially the Safety, Child Safety and Basic Course sections.

Take care with certain materials

Read the section 'Fragile Dishes' before washing china with unglazed decoration or other household goods made of plastic, wood or crystal requiring careful treatment.

Check the door

Check that the door of the dishwasher fits properly: open the door a little and let it go. Does it stay exactly where you released it? If not, you should check the installation instructions or consult the installer.

Check the water hardness level

Phone your local Water Board to check the water hardness in your area. This is important when dispensing dishwasher detergent and rinse aid.

If you have a machine with a water softener

Once you know the water hardness, you can set the water softener, see Settings. Before you start dishwashing, you must also fill with salt, see Salt.

Safety



General

Winter storage/Transport

- Read and keep the directions for use!
- Installation of water, drainage and electricity must be carried out by a qualified professional.
- Do not use the dishwasher for any purposes other than those stated in these directions for use.
- Do not load the dishwasher door or the dishwasher baskets with anything other than dishes.
- Only use **dishwasher** detergent!
- Place knives and other sharp objects so that they cannot cause injury to people or damage the dishwasher.

Never put dishes containing solvent residue in the machine due to risk of explosion. Neither may dishes containing ashes, wax or lubricating grease be washed in the dishwasher.

Winter storage/Transport

Store the machine away from frost.

Avoid long journeys in extreme cold. Transport the machine in an upright position or lying on its back.

Overfill protection

The overfill protector starts pumping out water and closes off the water intake if the machine's water level exceeds the normal level. If the overfill protector starts up, shut off the water supply and phone for service. See 'Troubleshooting' on pages 26-28.

Cleaning

Only use a slightly damp cloth for cleaning around the edge of the door. Do not use a spray bottle! Water can penetrate into the lock and come into contact with the electrical components.

Packaging materials

Sort at source in accordance with the recommendations of your local authority.

Scrapping

When the time comes for the machine to be scrapped, it should immediately be rendered unusable. Remove the plug and cut off the lead as short as possible.

Contact your refuse collection department or your local authority for information on the correct way to dispose of the machine! The machine is manufactured and labelled for recycling.

Child Safety!



KidLock™



KidSAFE™

Child-safe button lock

To prevent children starting the machine, you can activate a button lock.

Proceed as follows:

1. Switch off the dishwasher with the main switch.
2. Hold in the Temperature and Drying buttons, and at the same time switch on the main switch.

The Temperature, Drying and start symbols will then flash. Release the Temperature and Drying buttons.

4. Press the Program selection button. Once the symbol for Pots & pans lights up, the button lock has been activated.

5. Press the Start/Stop button to store the setting.

Once the button lock has been activated, the Temperature and Drying symbols will flash when any of the buttons are pressed.

To deactivate the button lock temporarily when you want to start the machine, press the Temperature and Dry buttons simultaneously. The button lock will then automatically switch on again after 3 minutes.

To deactivate the button lock altogether, use the same procedure as for activation. When the symbol for Pots & pans goes out, the button lock has been deactivated.

Advice!

You can read more about this in the Settings chapter.

Child-safe dishwashing

- Use the knife basket, or knife holder, for all long/sharp items.
- Always close the door and start the program immediately once dishwasher detergent has been added.
- Keep children away from the dishwasher when it is open. There might be remains of dishwasher detergent present!
- Do not allow children to use or play with the dishwasher. Always take particular care when the door is open.

Protect your children!



- Dishwasher detergent is corrosive!

WARNING: Dishwasher detergents are strongly alkaline. They can be extremely dangerous if swallowed. Avoid contact with skin and eyes and keep children away from the dishwasher when the door is open.

Check that the detergent compartment is empty after completion of the wash cycle.

Store dishwasher detergent and rinse aid out of the reach of children! Should dishwasher detergent be swallowed, immediately drink one or two glasses of milk or water. Do not attempt to induce vomiting. Contact a doctor! Should dishwasher detergent come into contact with the eyes, rinse (for at least 15 minutes) with copious amounts of water.

Parts of the dishwasher*

1. Knife basket
2. Upper basket
3. Lamp
4. Spray arms
5. Lower basket
6. Cutlery basket
7. Rinse Aid Filling
8. Dishwasher detergent compartment
9. Main switch
10. Program panel
11. Filter
12. Type plate

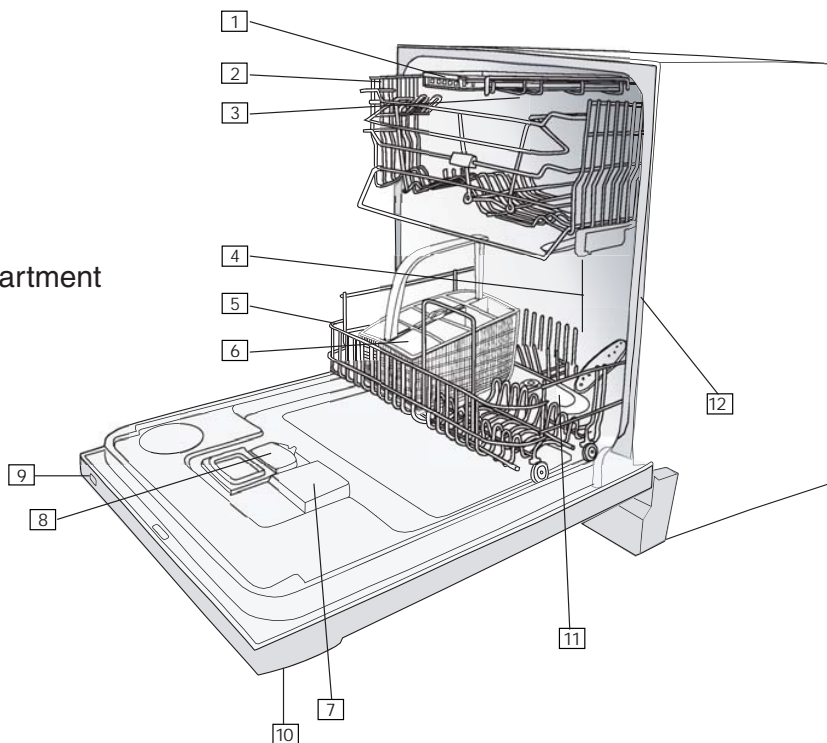

* Details may differ depending on model and market!

Technical information

Height	820-870 mm
Width	596 mm
Depth	550 mm****
Weight	48 kg/51 kg with water softener*
Capacity**	14 place settings
Water pressure	0.03-1.0 MPa (0.3–10 kp/cm ²)
Connection	1-phase, 230 V, 50Hz 10/10A***
Max output	1 900 W****
Accessories	Work surface, Side panels, Anti-tilt

* Details may differ depending on model and market!

**In accordance with standard, AS/NZS 2007.

***See type plate.

****Without fitted wooden door.

Baskets*



Upper basket

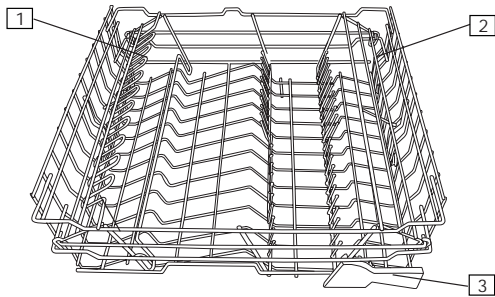

1. Wine glass shelf
2. Cup rack
3. Knife stop
4. Folding plate stand
5. Folding door and handle

*Details may differ depending on the model and market!

Lower basket

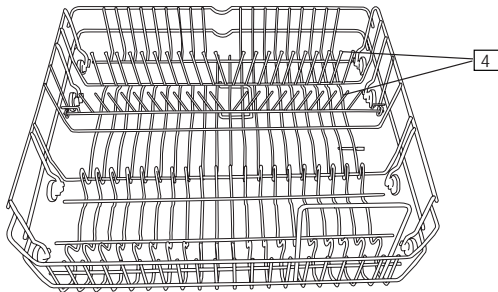

Cutlery basket

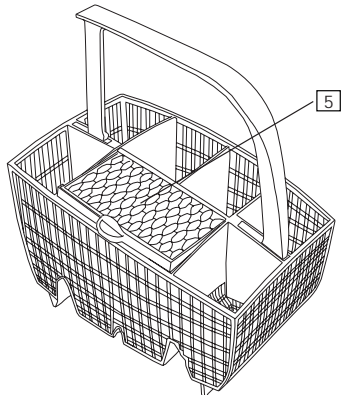

Knife basket

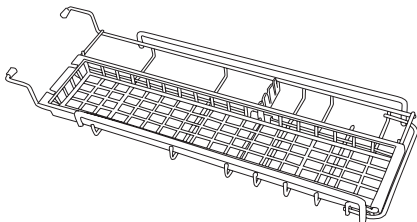

Control panel

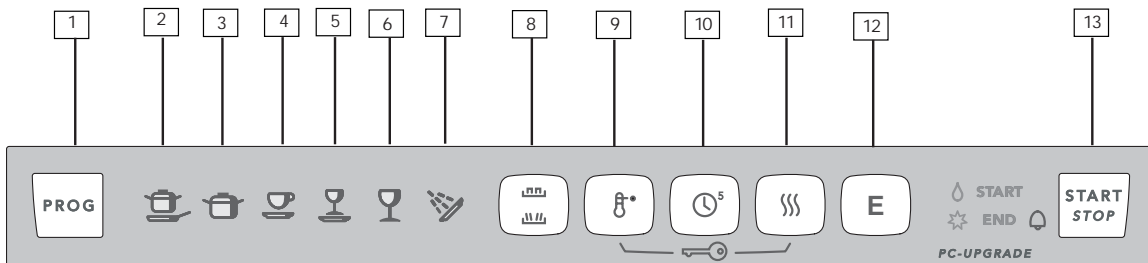

1. Program selector
2. Pots & Pans
3. Heavy wash
4. Normal wash
5. Delicate wash
6. Quick wash
7. Rinse & Hold

8. Upper/ Lower basket
9. Temperature
10. Delayed start 5 hours
11. Drying
12. Express
13. Start/stop

Dispenser

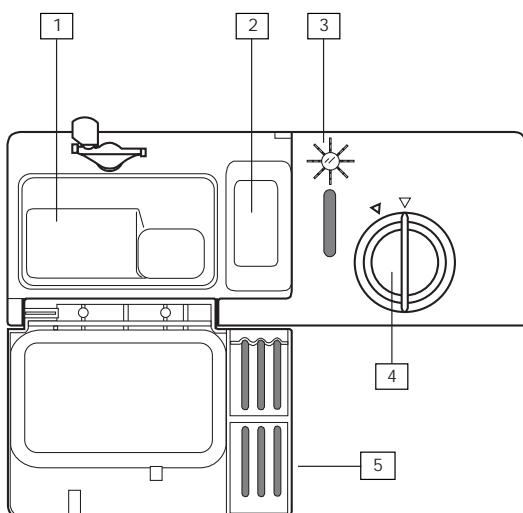

1. Compartment for main wash dishwasher detergent
2. Compartment for pre-wash detergent
3. Refill indicator rinse aid (not all models)
4. Rinse aid cover
5. Detergent compartment cover

Below are step by step instructions to help you achieve the best possible dishwashing results.

1 Load the baskets correctly!

Your dishwasher is equipped with Super Cleaning System™. It is therefore not necessary to rinse the dishes before washing.

Simply remove large food particles and debris. Convenient and environmentally friendly!

Place glasses, cups, bowls, side plates and dishes in the upper basket, wine glasses should be placed on the shelf with the wavy edge, and knives in the knife stand if present.

NB!

Ensure that all soiled surfaces face inwards or downwards! As depicted.

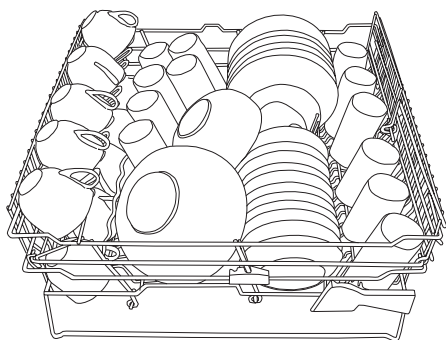

Place dinner plates, side plates, serving dishes, saucepans and cutlery (in the cutlery basket) in the lower basket. The removable plate insert, which comes with certain models, can be easily removed to provide room for large plates, saucepans and pots, or placed in three alternative positions.

Stand the cutlery with handles downward and as spread out as possible. Ensure that spoons are not resting inside each other.

Do not put cutlery made of different materials, e.g. silver and stainless steel, in the same compartment (risk of stains).

The cutlery basket has a folding flap in the middle for small items or narrow shafts, such as electric whisks.

Place long cutlery and carving knives in the special knife basket (if available) or in the upper basket.

Check that the spray arms are able to move freely.

See the section entitled Fragile Items if you want to wash objects that may be fragile.

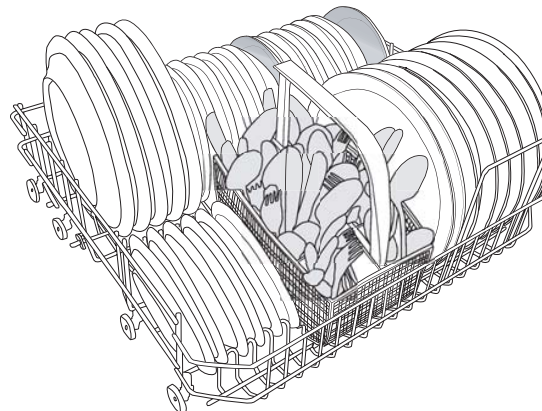

2 Detergent dosage

Detergent should be dosed in accordance with the water's hardness level.

Follow the dose instructions on the detergent package. If your machine is fitted with a water softener, dispense for soft water.

Pour the dishwasher detergent into the dishwasher detergent compartment. There is one compartment for pre-wash and one for main wash, see Dispenser. Phone the dishwasher detergent manufacturer if you have any questions regarding the detergent.

CAUTION!

Protect your children!



- Dishwasher detergent is corrosive!





NB!

Only use dishwasher detergent

Detergent for washing by hand cannot be used as the build-up of foam impedes the machine's performance.

3 Press the main power switch



4 Select program

Select a program by pressing the program selector one or more times until the required program is displayed.



Pots & pans

Use this program to wash very heavily soiled dishes, saucepans and pots. This program uses the highest wash temperature and is consequently the most effective against dirt.





Heavy wash

The Heavy Wash program should be used for heavily soiled dishes, e.g. saucepans, pots and gratin dishes. If there is still space in the machine after loading such items, you can add plates etc.



Normal wash

Used for washing normally soiled dishes such as plates, serving dishes, cups and glasses, etc.

For washing normally soiled dishes use the **Normal wash program**  with **normal temperature** ° and **normal drying** .

To save more water and energy use economy temperature and economy drying.



Delicate wash

If the dishes are not heavily soiled, you can select Delicate wash. This program is intended for glass and china which has just been used and therefore does not need such a powerful program.

Fragile dishes

can be washed using the Delicate wash program. Deselect the heat dry if you want to be particularly careful. See also the chapter on Fragile dishes.



Quick wash

Select Quick Wash if the dishes are very lightly soiled. This program is used for very lightly soiled glass and china, e.g. coffee cups.



Rinse & Hold

For rinsing the dishes while waiting for the machine to be filled.



+ Rinse & Dry

The Rinse & Dry program comprises one rinse with heat and drying. It is a suitable program if you are planning to make jam and want to rinse and warm previously washed glass jars.

If you wish to use additional options, continue to point 5. Otherwise you can now start the machine, see point 6.

Options

5 Select options

To select an option, press one of the option buttons

Upper / Lower basket

By pressing the option button for upper basket/lower basket (see display picture page 10), you can choose to wash only the upper basket, the lower basket or both baskets. The appropriate symbol lights up to show which basket has been selected to be washed. Both symbols will light up when both baskets are to be washed.

° Temperature

With the temperature option button you can select the wash temperature.

Program	Normal °C	Eco °C
Pots & pans:	75	60
Heavy wash:	70	50
Normal wash:	65	45
Delicate wash:	55	40
Quick wash:	55	30

The temperature symbol will light up if you have chosen the **normal** temperature. This selection will remain in force until a change is made.

⁵ Delayed start

If you want the machine to start later, press the Delayed start option button. The clock symbol on the button lights up. Then press the Start/Stop button and the machine will start the program 5 hours later. To cancel delayed start, hold down the Start/Stop button for three seconds.

Drying

If you require a better drying result, press the option button Drying to select normal drying. A symbol in the form of three wavy lines lights. If you want a program with Eco drying – press it again and the symbol will go out. The fan dries the dishes even if Eco dry was selected, although not in the Quick Wash program.

E Express

By selecting the Express option, the washing time is reduced and the wash temperature lowered by 10°C. Cannot be used in the Quick wash or Rinse & Hold programs.

6 Press Start/Stop and close

the door

The dishwasher will now start. It manages the entire wash automatically. Ensure that the door is properly closed or the machine will not start.

Changing options

If you want to change program after having started the machine, press the Start/Stop button for three seconds. Then select a new program and then press the Start/Stop button again.

Do you want to load more dishes?

Open the door; the machine stops automatically, put in the dishes, close the door and the dishwasher will continue from where it left off.

If the machine is switched off from the main switch

(or in the event of a power cut) before the washing program has been completed, the interrupted program will continue when power comes back on.

NB!

If the power is switched off, or if the door is open for more than 2 minutes during drying, the program is interrupted.

7 After dishwashing

Once the machine has finished, it is only drawing standing current. Should you wish to disconnect the current completely, just switch off at the main switch. Turn off the water tap if the machine is not to be used for an extended period, e.g. during holidays.

Advice!

For even quicker drying, allow the door to stand slightly ajar.

Eco-dishwashing

Only wash with a full load

Waiting to run the wash until the machine is full saves energy.

Wash at a lower temperature

If the load is only lightly soiled, you can lower the temperature.

Select program with Eco drying

If you select an Pots & pans/Heavy/Normal or Delicate Wash program with Eco dry, this will save energy. You will get a better drying result if you leave the door slightly open after the end of the program.

Do not rinse before dishwashing

Thanks to the dishwasher's Super Cleaning System™ you do not need to rinse the dishes under running water before loading them into the machine.

Choose environmentally-friendly dishwasher detergent

Read environmental declarations on the package!

Connect to cold water supply

If the machine is connected to the cold water, the operating time will be longer, as it takes longer to heat up the water. However, the extended washing time means that it is possible to operate a program with a lower washing temperature and still achieve the same results.

Fragile dishes

A number of household goods are not suitable for machine washing. There can be many reasons for this. Certain materials cannot withstand intense heat, others can be damaged by the dishwasher detergent.

Fragile decoration

China with decoration on top of the glaze (the article has a rough feel) should not be machine washed.

Crystal/ glass

Place the articles so that they do not knock together during the wash. Use the lowest possible wash temperature and the shortest possible program. Do not heat dry! Antique and very fragile items should not be machine washed.

Glass which is machine washed at high temperatures can in time develop a grey film which cannot be removed. Wash fine glass at the lowest temperature and with a low dosage of dishwasher detergent.

Silver

Silver and stainless items should not come into contact with each other as the silver can discolour.

Cutlery with glued handles

Certain types of adhesive cannot withstand machine washing. In such cases the handles can come loose.

Wood

Wooden articles should only be machine washed if they are labelled as dishwasher proof.

Aluminium

Aluminium can be dulled by machine washing. However, good quality aluminium saucepans can be machine washed, although a reduction in lustre should be expected.

Plastic

Certain types of plastic cannot withstand the high temperature generated in machine dishwashing.

To protect plastic articles

Select a program with Economy temperature and Economy drying.

Standard program

Program	Options		Program procedure					Consumption			Time	
	Temp	Drying	Pre-wash (nr)	Main wash °C	Rinses (nr)	Final rinse °C	Fan	Energy kWh		Water Litres	Min. (appr.)	
								Cold water (20°C)	Warm water (60°C)		Cold water (20°C)	Warm water (60°C)
Pots & pans	Normal	Normal	2	75	3	70	Yes	1,9	1,0	18,0	200	175
Heavy wash	Normal	Normal	2	70	3	70	Yes	1,7	0,9	18,0	195	170
Normal wash	Normal	Normal	2	65	2	70	Yes	1,5	0,8	15	140	120
Normal wash*	Eco	Eco	–	45	2	45	Yes	0,6	0,3	13	100	85
Upper basket	Eco	Eco	–	45	2	45	Yes	0,6	0,3	10	90	75
Lower basket	–	–	–	–	–	–	–	–	–	–	–	–
Delicate wash	Normal	Eco	–	55	2	55	Yes	1	0,6	9	105	90
Quick wash	Normal	Eco	–	55	2	–	–	0,7	0,5	8	85	75
Rinse & dry	–	–	–	–	–	–	–	–	–	–	–	–
Rinse & hold	–	–	–	–	1	–	–	0,01	0,01	3	4	4

* Tested program for Standard AS/NZS 2007.1:2003

**All quoted times are only indicative, fluctuations may occur.

Due to water temperature, water pressure, variations in voltage etc.

Hot water connection approx. 60°C.

Cold water connection approx. 15°C.

Cleaning

Cleaning

The dishwasher's inner container is made of stainless steel and is kept clean through normal use. However, if you have calciferous (hard) water, lime deposits can form in the dishwasher. In this case, run a normal wash program with two tablespoons of citric acid in the dishwasher detergent compartment.

Coarse filter

The coarse filter collects large food particles which cannot get past the outflow pump. Lift out and empty the coarse filter as necessary. Don't forget to replace it!

Fine filter

The residue collected on the fine filter is automatically rinsed off with each wash. The fine filter should still be cleaned once or twice a year.

1. Remove the fine filter by first turning the filter's tubular strainer anti-clockwise and then lifting the tubular strainer and the coarse filter straight up.
2. Clean with a dishwashing brush. Ensure that the edges are properly sealed when replacing the fine filter.

Drain pump

The pump can be accessed from the inside of the machine.

1. Always remove the plug from the wall socket before you clean the pump.
2. Remove the coarse screen first by pressing together the two lugs and pulling the screen upwards.
3. Now loosen the tubular part of the screen by turning it anticlockwise and removing the fine screen.
4. Finally remove the small adapter to the left of the bottom drain.
5. It's possible, by inserting your finger in the hole, to turn the pump impeller and remove any blockage.
6. Refit the adapter and screens.
7. Insert the plug in the wall socket.

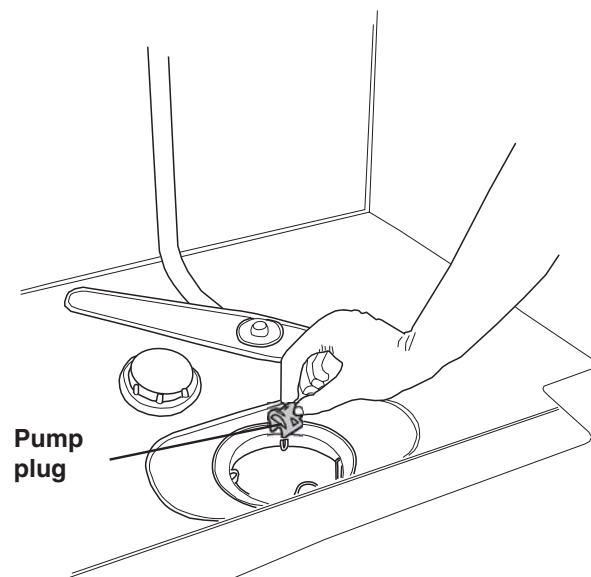
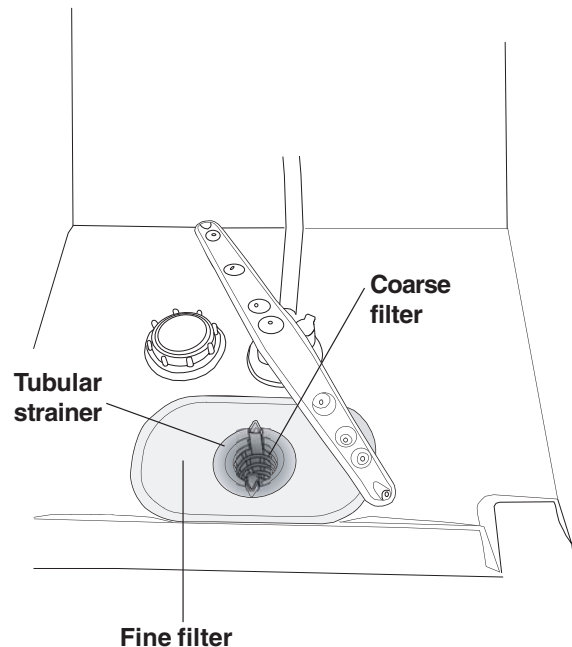

If you still cannot start the machine and a humming noise can be heard, then the overfilling protection has been activated.

- Shutoff the water
- Remove the plug from the wall socket
- Call Service

CAUTION!



Do not forget to replace the pump plug.

Spray arms

The holes and bearings can occasionally become clogged.

1. Pull the lower spray arm straight up to release it.
2. Scrape away the debris with a needle or similar. The spray arms also have holes on the underside.

To release the upper spray arm, the upper basket must be removed.

3. Pull out the basket and turn the basket stop outwards on both rails (see picture). The basket can now be removed.
4. Remove the upper spray arm in the same way as the lower arm and clean it.

Door

When cleaning the edge around the door, use only a slightly damp cloth, possibly with a little detergent. Do not use a spray bottle or similar around the door catch. This is to ensure that water does not penetrate into the door catch and come into contact with the electrical components.

CAUTION!



Do not use a spray bottle or similar around the door catch.

Tip!

In order to prevent bad odours in the dishwasher, clean the strips and corners with a dish brush and low-lather detergent.

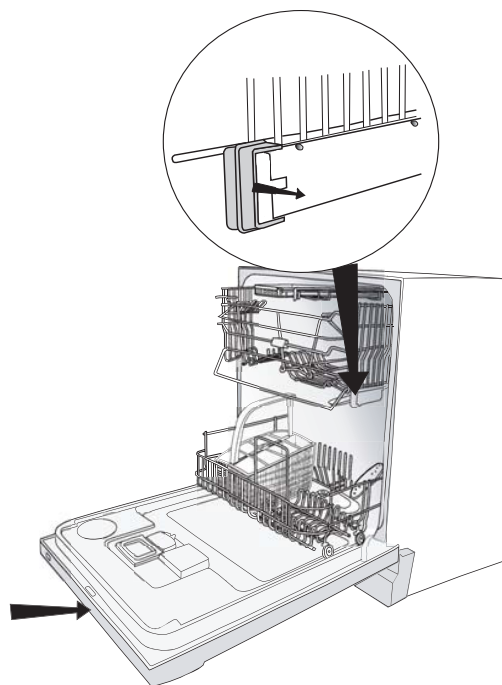
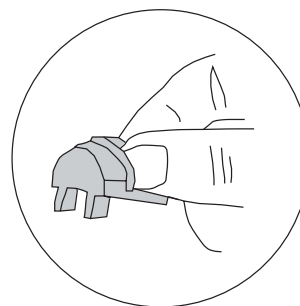

Rinse aid

Pour in rinse aid

Rinse aid, helps quicken the drying process.

Machines with indicator on the panel

When the rinse aid has run out and more is needed, the rinse aid symbol on the panel lights up*.

To fill with rinse aid:

1. Turn and lift up the cover of the rinse aid compartment to the right of the dispenser. This is where you top up and set the amount of rinse aid to be dispensed in each wash.

2. Carefully pour in rinse aid up to the knob for dosage setting.

Alter dosage if required. Do not forget to close the cover.

***NB!**

After filling there may be a short delay before the signal light goes out.

Machines with refill indicator

There is a refill indicator in the middle of the dispenser (see picture). If the refill indicator is totally black, there is sufficient rinse aid. However, if the indicator has a more transparent appearance, you need to top up with rinse aid (see above).

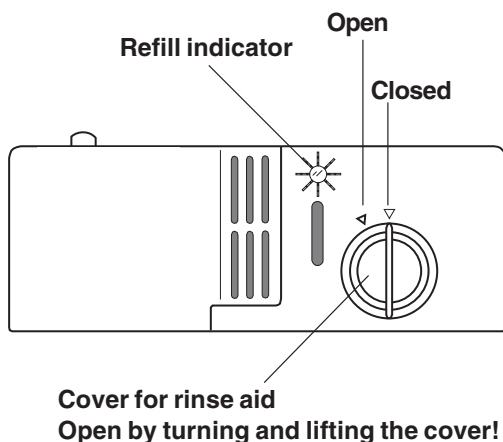

Select dosage

The dispenser is usually set at 1= soft water. However, depending on the water hardness, it may be necessary to change the dosage.

Open the rinse aid cover. Here you will find the dispenser's adjustment dial. Settings 1-6: the harder the water, the higher the dosage. When the water hardness exceeds 10-12 °dH you should use rinse aid with citric acid (acid rinse aid) if the machine does not have a water softening filter. If the machine has a water softening filter, dispense as for soft water.

Too much rinse aid can lead to the build-up of foam. If your water is particularly soft, you can dilute the rinse aid (1 part rinse aid, 1 part water).

Too much rinse aid can cause streaks on the dishes, while too little can result in water stains.

Salt

(applies to dishwashers with water softeners)

Pour in salt

Before using a dishwasher with a water softening filter, you must fill the salt compartment with salt. Use coarse salt or special salt for dishwashers.

It is best to fill with salt when you are about to do a wash, as the dishwasher needs to be rinsed out immediately after filling.

Proceed as follows the first time:

1. First unscrew the cover as illustrated.
2. Place the funnel, which is supplied with the dishwasher, into the compartment's filler hole. First pour in approximately 1 litre of water.
3. Then fill the compartment with max 1.5 kg salt.
4. Wipe away excess salt so that the cover can be properly screwed into place.
5. Run a Normal wash program so that any salt in the machine is rinsed away.

When the salt runs out, the salt symbol on the display* lights up (this function is not available on all machines). Unscrew the cover and fill the compartment with salt. Water is only needed on the first occasion! Wipe clean and screw back in place. Run a Normal wash program so that any salt is rinsed away.

The indicator is not working

If the indicator is not working, this may be because the float, which is positioned under the cover, has become stuck in salt residue. The float can be reached through the green arm located under the cover of the salt compartment. Move the float arm up and down to loosen it. Once the float has been loosened, press it down again.

Models without a salt symbol in the display show green in the salt compartment cover when there is sufficient salt.

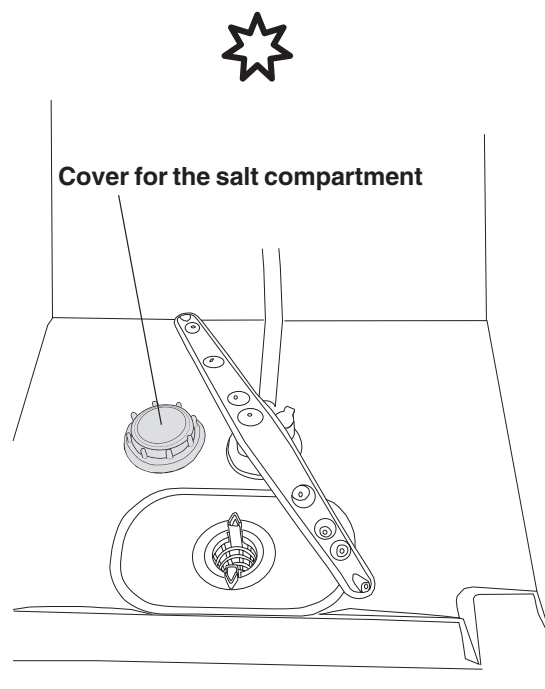

*NB!

After filling, there may be a short delay before the signal light goes out.

CAUTION!



Never pour dishwasher detergent into the salt compartment. It will destroy the water softener!

Settings

Reprogramming

Some of the machine's functions can be reprogrammed. Please read below. The selection will be retained until the next time you reset this function.

Even if the machine is turned off at the main switch or loses power for any other reason, all selections registered before the interruption of power will be retained.

Child-safe button lock

You can prevent a child starting the machine by accident or changing the settings by programming the machine with a button lock, which requires the Temperature and Drying buttons to be pressed simultaneously to start up the machine. The button lock will automatically be reactivated after three minutes.

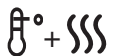
- ① 1. Switch off the dishwasher with the main switch.
-  2. Hold in the Temperature and Drying buttons while pressing the main switch. The Temperature, Drying and start symbols will flash. Release the Temperature and Drying buttons.
- PROG** 3. Press the Program button – when the Pots & pans symbol is lit, the button lock has been activated
- START
STOP** 4. Then press the Start/Stop button to store the setting.

or **Reset:**

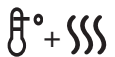
- ① 1. Switch off the dishwasher with the main switch.
-  2. Hold in the Temperature and Drying buttons at the same time as pressing the main switch
- PROG** 3. Press the Program button – when the Pots & pans symbol goes out, the button lock has been deactivated
- START
STOP** 4. Then press the Start/Stop button to confirm the setting.

Super rinse

Super rinse means that two extra rinses will be added at the end of the main dish. Cannot be used in the Quick wash and Rinse & Hold programs.

- ① 1. Switch off the dishwasher with the main switch.
- E** + ① 2. Hold in the Express button while pressing the main switch. The Express button and Start will flash. Release the Express button.
- PROG** 3. Press the Program button – when the Intensive wash symbol  is lit, the Super rinse has been activated
- START**
STOP 4. Then press the Start/Stop button to store the setting.

or **Reset:**

- ① 1. Switch off the dishwasher with the main switch.
- E** + ① 2. Hold in the Express button at the same time as pressing the main switch.
- PROG** 3. Press the Program button – when the Intensive wash symbol goes out the Super rinse has been deactivated.
- START**
STOP 4. Then press the Start/Stop button to confirm the setting.





Setting water hardness

If you have a dishwasher with a water softener, you may need to change the setting, depending on the degree of hardness of the water. Phone your local Water Board to check the water hardness in your area. The dishwasher is set for low water hardness on delivery.



1. Switch off the dishwasher at the main switch.

**START
STOP**

2. Press the main switch while holding in the Start/Stop switch. Release the Start/Stop button.

PROG

3. Press the Program button from one to six times depending on the hardness of the water. Program symbols will light up as you press. See illustration.

Setting water hardness						°dH	°fH
*	*	*	*	*	*	0-5	0-9
						6-8	9-14
						9-14	15-25
						15-19	26-34
						20-29	35-52
						30-44	53-79
						45+	80+





* All program indicators extinguished: Machines without water softeners and machines with water softeners and low water hardness.

**START
STOP**





4. Press the Start/Stop button and the setting will be stored until next time you want to make a change.

Setting a signal

If you want the machine to signal when the wash is complete, you can program it to do this. The machine is set without a signal by default.

-  1. Switch off the dishwasher with the main switch.
 -  2. Hold in the Delayed start button at the same time as you press the main switch. The button flashes. Release the button.
 - PROG** 3. Press the Program button – when the Pots & pans symbol lights up, the signal is activated.
 - START
STOP** 4. Press the Start/Stop button and the setting will be stored until next time you want to make a change.
- or **Reset:**
-  1. Switch off the dishwasher with the main switch.
 -  2. Hold in the Delayed start button at the same time as you press the main switch. The button flashes. Release the button.
 - PROG** 3. Press the Program button – when the Pots & pans symbol goes out, the signal is deactivated
 - START
STOP** 4. Press the Start/Stop button and the setting will be stored until next time you want to make a change.

Fault indications

Display		Type of fault	Action
	flashes	Too much water in the dishwasher	Phone service
	flashes	Fault with water inlet	Check that the water is on
	flashes	Valve leakage	Switch off the water tap and contact service
	flashes	Blocked drain	See 'Possible causes' in chapter Troubleshooting
	flashes	Clogged filter	Clean the filters, see chapter Cleaning

To remove the fault indications from the display, turn the main switch off and then on again.

Troubleshooting

Problems

The dishes are not clean.

Possible causes

- The spray arms are not rotating.
- Old dishwasher detergent. NB! Detergent is a perishable.
- Incorrect dosage of detergent.
- Insufficiently powerful dishwashing program.
- Incorrect program chosen.
- Incorrect loading of the dishwasher.
- Glasses and cups have tipped over during the wash.

Action

- Lift off the arms and clean.
- Avoid large packs.
- Dispense according to the level of water hardness.
- Select the Temperature normal option or switch to a more powerful program.
- Change to a more intensive program.
- Do not cover china with large bowls or similar.
- Avoid placing very tall glasses in the corners of baskets.
- Load the china securely.

Stains or a film on the china.

- Dishwasher fitted with water softener is leaking salt.
- Incorrectly set water softener.
- Incorrectly set rinse aid dispenser.
- The salt compartment is empty.
- Phosphate-free detergent in combination with hard water.
- Too high a temperature and/or too much detergent can cause etching on (crystal) glass. Unfortunately this cannot be remedied, only prevented!

- Check that the cover of the salt compartment is properly screwed on. Otherwise phone for Service.
- See the chapter on water softeners.
- See the chapter on rinse aid.
- Top up with salt.
- Change detergent.
- Wash (crystal) glass at a low temperature and dispense dishwasher detergent with care. Contact the dishwasher detergent manufacturer.





Problems

The china has a whitish-blue sticky film.

Stains on stainless steel or silver.

Stains which remain after dishwashing.

Rattling sound during dishwashing.

The machine will not start.

To restart the machine, press Start/stop for 3 seconds. Now select a new programme and press Start/stop.

Possible causes

- Too high dosage of rinse aid.
- Certain food remnants such as mustard, mayonnaise, lemon, vinegar, salt and dressings can cause stains on stainless steel if allowed to remain for any length of time. All stainless steel can mark silver if allowed to come into contact during the dishwashing process. Aluminium can also cause stains on dishes.
- Lipstick and tea can be difficult to remove.
- The dishes are not properly loaded or the spray arms are not rotating.
- You have forgotten to switch on the main switch.
- The door is not properly closed.
- A fuse has blown.
- The plug is not plugged in.
- The water tap is off.
- Overfilling/leakage
- A droning sound (drainage

Action

- Reduce dosage. See the chapter on rinse aid. If the water is very soft, you could try diluting the rinse aid (1 part rinse aid, 1 part water).
- Rinse off food residue of this type if you do not intend to start the dishwasher immediately.
- Separate your cutlery into the various compartments in the basket. Make sure silver and stainless steel are not together.
- Change to a detergent with bleach.
- Check that the china is loaded securely. Spin the spray arms to make sure that they rotate.
- Check
- Check
- Check
- Check
- Check
- 1. Close the water tap.

Problems

Possible causes

Action

	<p>pump) can be heard from the machine, this does not stop when the power is switched off using the main power switch.</p>	<ol style="list-style-type: none">2. Pull out the plug.3. Call a service engineer
Water remains in the machine.	<ul style="list-style-type: none">• Obstruction in the drain hose.• Kinks in the drain hose.• The filters are clogged.• Items in the drain pump.	<ul style="list-style-type: none">• Disconnect the drain hose where it is connected to the sink's water trap. Check that no debris has become stuck. Is the cone-shaped part of the pipe cut so that the diameter is at least 16 mm?• Check that the hose is free from kinks or sharp bends.• Clean out the coarse filter, the fine filter and the filter.• Clean out the drain pump. See chapter on cleaning
Bad odour in the machine	<ul style="list-style-type: none">• Dirt along the strips and in corners	<ul style="list-style-type: none">• Clean with a dish brush and low-lather detergent.
The dishes are not sufficiently dry	<ul style="list-style-type: none">• Drying power too low. The machine is not fully loaded. The rinse aid has run out or the set dose is too low.	<ul style="list-style-type: none">• Activate the Normal drying option (not all models). Put a full load in the machine. Replenish rinse aid or increase the dose of rinse aid. Open the door slightly once the program has finished.

Performance information

Test dosage

Heavy wash/Normal wash

Main wash 25 gram Standard detergent.

Rinse aid dosage 3.

Energy labelling

Australia:

AS/NZS 2007

Dishwasher program:

Normal wash 45°C, Eco drying.

Program time:

100 minutes.

Connection:

Coldwater

Test method noise measurement:

IEC-704-3

Example of dishwasher loading



AS/NZS 2007.1:2003



AS/NZS 2007.1:2003

Technical information

Height:

820-870 mm

Width:

596 mm

Weight:

48 kg*

51 kg with water softener*

Capacity:

14 IEC place settings

Water pressure:

0.03-1.0 MPa

0.3-10 kp/cm² (Bar)

3-100 N/cm²

Connection:

See type plate

Output:

See type plate

*The weight can vary due to varying specifications.

Installation

Suggestions on positioning the dishwasher

The dishwasher can be built in, fully free-standing or semi-free-standing.

CAUTION!



Connection to electricity, water and drainage must be carried out by a suitably qualified person.

A. Built-in

The dishwasher can be built in under a worktop with a working height of 820 - 870 mm. The width measurement must be at least 600 mm. For additional measurements, see picture.

B. Freestanding

A freestanding dishwasher must be fitted with anti-tilt. This comprises two fastening irons which are screwed into place as illustrated. The dishwasher is then pushed in so that the fastening irons grip onto the rear feet. The dishwasher cannot now tilt in the event a load is placed on the open door. If the dishwasher is to be fully freestanding, both side panels and the work top should be fitted. These accessories can be purchased where you purchased the dishwasher.

Tip!

A machine with side panels and a counter top (freestanding) can, of course, also be installed as a built-in unit.

C. Semi-free-standing

If the dishwasher is positioned so that either side is visible, a side panel can be fitted. These accessories can be purchased where you purchased the dishwasher.

Built-in installation

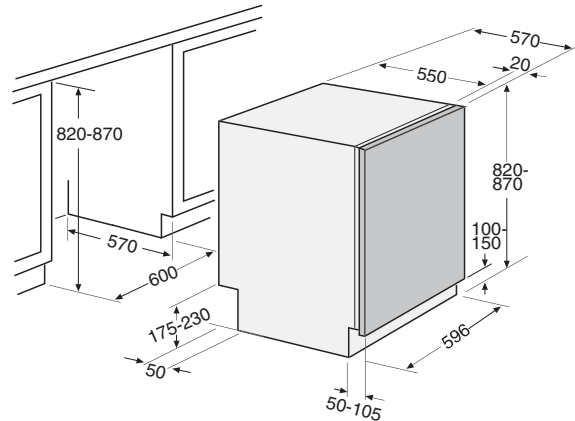

Freestanding installation

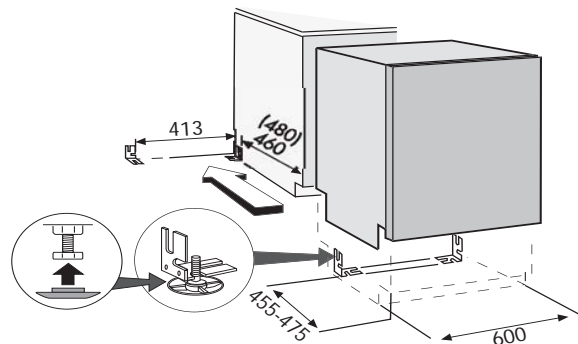

CAUTION!



A fully freestanding dishwasher must be fitted with anti-tilt.





Connection to water

There must be a shut-off tap on the water supply pipe. The shut-off tap should be positioned above the work surface or at the front of the sink unit.

The water supply pipe has a connection with a 1/2" or 3/4" internal thread depending on country.

When the installation is complete, the shut-off tap should be opened to allow the pressure to settle for a while and to check that all connections are tight.

NB!

It is recommended that connection should be to cold water.

Connection to electricity

A dishwasher fitted with a lead and plug must be connected to an earthed socket. Repairs and maintenance relating to safety or performance must be carried out by a qualified professional.

Technical data

See the type plate on the right hand side of the door.

Connection to drainage

NB!

The hose must be fastened level with the underside of the sink unit.

CAUTION!



The lead must be disconnected or the socket voltage-free while the work is carried out!

Connection to drainage

When the drain hose is routed to a connection nipple at the sink's water trap (see illustration 1), note that the hose must be fastened level with the underside of the sink unit – otherwise the dishwasher from the sink can run down into the dishwasher. The drain hose is threaded onto a cone-shaped connecting pipe at the sink unit's water trap. The cone-shaped pipe must be cut to an internal diameter of at least 16 mm. For other alternative connections, see illustrations 2 and 3.

The drain hose may be lengthened by a maximum of 3 m (the total length of the drain hose may not exceed 4.5 m). Any connections and connecting pipes must have an internal diameter of at least 16 mm. However, the drain hose should ideally be replaced with a new hose without joints.

No part of the drain hose may be more than 950 mm above the bottom of the machine. The hose must not be routed directly to the floor drain or similar. In such cases, the hose can act as a siphon and empty the dishwasher.

The hose must always discharge at least 350 mm above the bottom of the machine.

Illustration 1

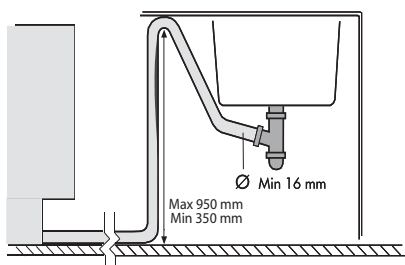

Illustration 2

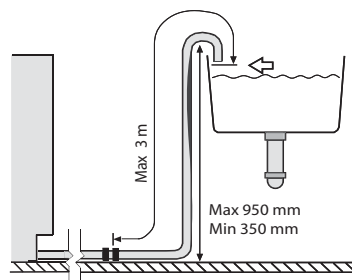
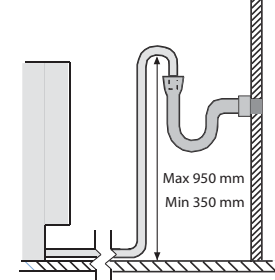

Illustration 3



Positioning the machine

A. Adjusting machines with six feet (freestanding dishwasher)

1. Adjust the height of the dishwasher with the four steel feet.
 2. Lock the feet with the nuts.
- NB! The dishwasher must not be allowed to lean more than 5 mm.

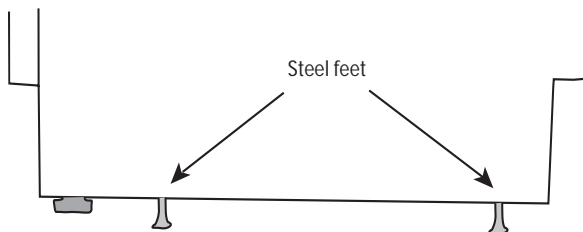

3. After the steel feet have been adjusted, screw down the two rubber feet tightly against the floor.
- The rubber feet now work as anti-tilt protection.

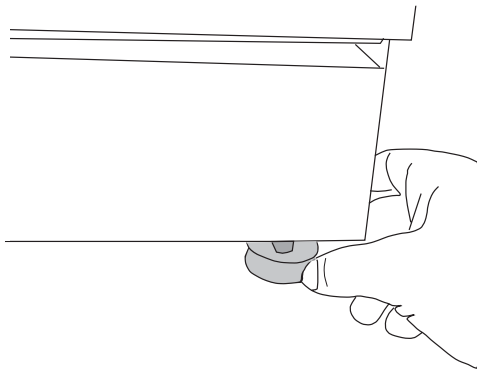

B. Adjusting machines with three or four feet

1. Start by measuring the height from the floor to the underside of the work top of your kitchen bench.
2. Install the sliding feet on the dishwasher.

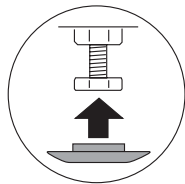

3. Measure the height from the floor to the top edge of the dishwasher.
4. Adjust all the feet by screwing them

- clockwise to raise or anti-clockwise to lower.
5. Check that the height of the machine corresponds to the height from the floor to the underside of the work surface. Tighten the locking nuts (locking nut) on the rear feet.
6. Push the dishwasher into place.
7. Finely adjust the front feet (the machine may lean max. 5 mm) and tighten the locking nuts.

C. Adjusting machines with adjustable foot

1. Start by measuring the height from the floor to the underside of the work surface.
2. Install the sliding feet on the dishwasher.

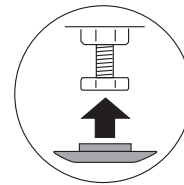

3. Measure the height from the floor to the top edge of the dishwasher.
4. Tilt the dishwasher forward a fraction and roughly adjust the rear foot by screwing the set screw at the front clockwise to raise or anti-clockwise to lower (illustrated below). Use a broad screwdriver or a hexagonal head screwdriver.
5. Adjust the front feet by turning them clockwise to raise or anti-clockwise to lower.
6. Check that the height of the machine corresponds to the height from the floor to the underside of the work surface.
7. Push the dishwasher into place.
8. Finely adjust the feet (the machine may lean max. 5 mm) and tighten the locking nuts on the front feet.

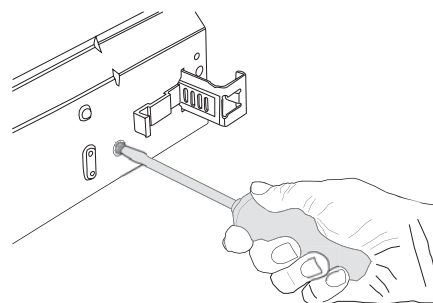



To prevent kinks, pull the drain hose and the connecting pipe.

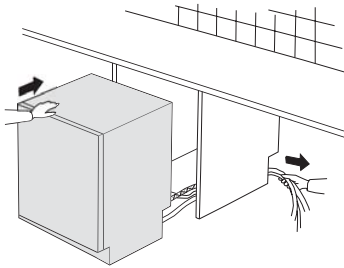

Adjusting the plinth

(Only if you have kick-plate as accessory)

The dishwasher has two kick-plates (certain models).

The taller one should be used if the machine is to be 850 - 870 mm high and the plinth depth can be varied between 45 - 105 mm. The lower one is to be used if the machine will be 820 - 845 mm with a plinth depth of between 50 - 105 mm.

Attach the enclosed felt insulation to the kick-plate (some models).

Set the correct plinth depth as follows:

1. Slide the grey catches towards each other and pull out the holders as far as required. Slide in the catches so that they lock the brackets in place.
2. Hang the kick-plate onto the holders by inserting it into the grooves.

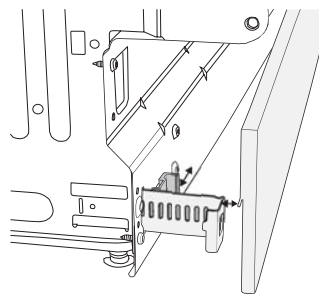

Screw the dishwasher into place

If the machine is to be screwed in at the sides, the enclosed plastic plugs are used for covering the screw holes. After fixing check that the front feet are in contact with the floor.

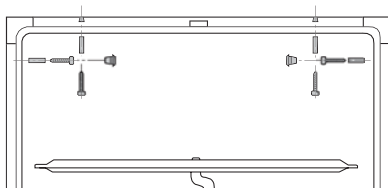

Fitting fixed kick-plate

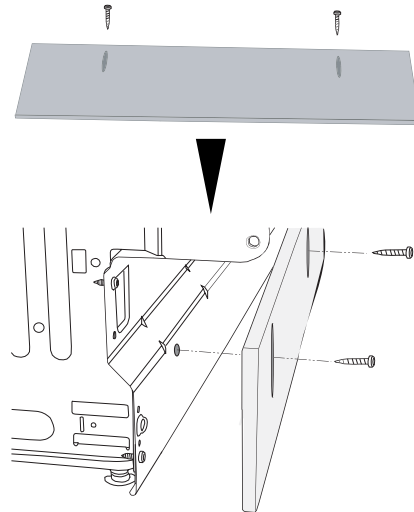

Fitting strip seal

(on the floorplinth covering plate)

Proceed as follows:

1. Remove the plastic plinth by gripping with both hands under the plastic plinth (A), and breaking outwards and upwards.

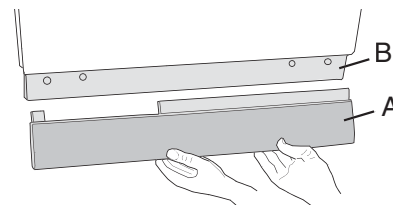

2. Undo the two screws on the covering plate (B).
3. Glue the accompanying rubber strip (C) to the underside of the covering plate (against the floor).
4. Screw the covering plate back into place. Adjust the covering plate so that the rubber strip is just in contact with the floor.

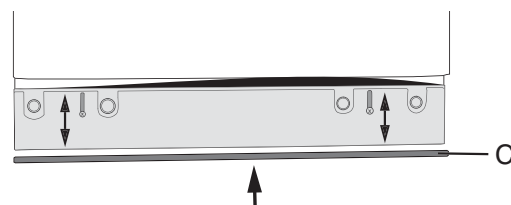





















5. Replace the plastic plinth

Setting water hardness

If you have a dishwasher with a water softener, you may need to change the setting, depending on the hardness level of the water. Phone your local Water Board to check the water hardness in your area. The dishwasher is set for low water hardness on delivery.

- ① 1. Switch off the dishwasher with the main switch.
- START
STOP** 2. Press the main switch while holding in the Start/Stop switch. Release the Start/Stop button.
- PROG** 3. Press the Program button from one to six times depending on the hardness of the water. Program symbols will light up as you press.

Setting water hardness						°dH	°fH
*	*	*	*	*	*	0-5	0-9
						6-8	9-14
						9-14	15-25
						15-19	26-34
						20-29	35-52
						30-44	53-79
						45+	80+

* All program indicators extinguished: Machines without water softeners and machines with water softeners and low water hardness.

- START
STOP** 4. Press the Start/Stop button and the setting will be stored until next time you want to make a change.

Service & guarantee

Service

Before calling for service, check to see whether the fault is due to something that you can rectify yourself. See Trouble shooting pages 26-28.

Guarantee

For guarantee details, see the guarantee card.

Search words

A

Advice! 7, 13
After dishwashing 13

C

Child safe 7, 22
Child-safe button lock 7
Citric acid 18, 20
Cleaning 6, 18
Connection 8, 17, 29, 31
Control panel 10, 20
Crystal 3, 5, 15, 26
Cutlery basket 8, 9, 11

D

Delicate wash 10, 12, 14
Dishwasher detergent 3, 6, 7, 11, 21
Display 21
Door 5, 13, 19, 30, 40
Drainage 18, 28, 31

E

Environment 3, 11, 14, 40

F

Fault indications 25

H

Hardness level 5, 20, 26, 34
Heavy wash 10, 12, 13, 29

I

Installation 6, 30

K

Knife basket 7, 8

L

Loading baskets 11, 40
Lower basket 8, 9, 11

M

Main switch 8, 13, 22, 23, 40

N

Normal wash 10, 12, 13, 18, 21, 29

P

Plastic 3, 5, 15, 33
Plinth 33
Pots & pans 7, 10, 12, 13

Q

Quick wash 10, 12, 13, 14

R

Recycling 6
Rinse aid 3, 5, 10, 20, 29
Rinse & Hold 10, 12

S

Salt 3, 5, 20, 21
Scrapping 3
Select Program 12, 14, 15
Service 6, 25, 35
Service & Guarantee 35
Settings 4, 22
Spray arms 11, 19, 40
Stains 26, 27
Standard program 16, 17

T

Temperature 7, 10, 12, 13, 14, 17, 22, 26
Transport 6

U

Upper basket 8, 9, 11, 19

W

Washing fragile items 12
Water 8, 13, 16, 17, 20, 23, 29, 31
Winter storage 3, 6

Quick Guide

SCS

SUPER CLEANING SYSTEM™

1. Loading baskets

Remove large food particles and debris. There is **no** need to rinse thanks to the Super Cleaning System™.



2. Dispensing dishwasher detergent

The detergent compartment has a small compartment for pre-wash and one for main wash.

3. Ensure that the spray arms can rotate freely

4. Turn on the main switch

5. Select program and press start

For washing normally soiled dishes use the **Normal wash program**  with **normal temperature**  and **normal drying** .

To save more water and energy use economy temperature and economy drying.

6. Close the door

Mini Program Guide

Program	Options		Program procedure				
	Temp	Drying	Pre-wash (nr)	Main wash °C	Rinses (nr)	Final rinse °C	Fan
Pots & pans	Normal	Normal	2	75	3	70	Yes
Heavy wash	Normal	Normal	2	70	3	70	Yes
Normal wash	Normal	Normal	2	65	2	70	Yes
Normal wash*	Eco	Eco	–	45	2	45	Yes
Upper basket	Eco	Eco	–	45	2	45	Yes
Lower basket	–	–	–	–	–	–	–
Delicate wash	Normal	Eco	–	55	2	55	Yes
Quick wash	Normal	Eco	–	55	2	–	–
Rinse & dry	–	–	–	–	–	–	–
Rinse & hold	–	–	–	–	1	–	–

* Tested program for Standard AS/NZS 2007.1:2003

Art. No: 80 785 75. Rev. 03• We reserve the right to make changes. Disclaimer! Not all models contain all  the features listed in this manual.

Printed on environmentally-friendly paper which meets the demands of Friends of the Earth and the