



USE AND CARE GUIDE

SAVE THESE INSTRUCTIONS FOR FUTURE REFERENCE

IMPORTANT!
To get the best performance from
your dishwasher, read all operat-
ing instructions before using it for
the first time.

D3331

CONTENTS

BEFORE USING YOUR NEW DISHWASHER	2
IMPORTANT SAFETY INSTRUCTIONS	2
CHILD SAFETY TIPS	2
DISHWASHER FEATURES	3
LOADING THE BASKETS	4
DETERGENT DISPENSER	5
DISHWASHING DETERGENT	5
RINSE AID DISPENSER	6
OPERATING INSTRUCTIONS	7
CARE AND CLEANING	9
OVERFILL PROTECTION	10
ENERGY SAVING TIPS	10
SOLUTIONS TO COMMON DISHWASHING PROBLEMS	11
TROUBLESHOOTING	12
WASHING SPECIAL ITEMS	14
INDEX	15
ASKO PRODUCT WARRANTY	16

BEFORE USING YOUR NEW DISHWASHER

- ◆ Read through this guide before attempting to use your new dishwasher.
- ◆ Read the "Washing Special Items" section before washing any porcelain or china that has "on-glaze" decoration, crystal glassware, or items of wood or plastic.
- ◆ Make sure the door is properly balanced. To do this, open it a little and release it. It should stay where you released it. If it doesn't, consult the *Installation Instructions* or contact your installer.
- ◆ Call your local water company to learn the water hardness in your area. You'll need to know this to determine how much detergent and rinse aid to use.

IMPORTANT SAFETY INSTRUCTIONS

This manual does not cover all possible conditions and situations that may occur. Common sense and caution should always be used when installing, operating, and maintaining any appliance.

- ◆ Read all instructions before using the dishwasher.
- ◆ Dishwashers must be electrically grounded. Read the *Installation Instructions* for details.
- ◆ Use the dishwasher only for its intended purpose.
- ◆ Do not run the dishwasher while you are out of the home.
- ◆ Use only automatic dishwasher detergents and rinse agents.
- ◆ To reduce the risk of injury, keep detergents and rinse aids out of the reach of children.
- ◆ Do not load sharp items near the door; you could damage the door seal.
- ◆ Place sharp knives in the silverware basket with the sharp ends down to avoid the risk of cut-type injuries.
- ◆ Do not wash plastic items unless they are marked "dishwasher safe" or the equivalent. For items not marked, check the manufacturer's recommendations. Items not dishwasher safe could become deformed or melt and create a potential fire hazard.
- ◆ Do not touch the heating element during or immediately after use.
- ◆ Do not operate the dishwasher unless all enclosure panels are properly in place (i.e., guard plate, access panel, toe kick, etc.)
- ◆ Do not tamper with controls by removing or changing.
- ◆ Do not abuse, sit on, or stand on the dishwasher door or baskets .
- ◆ To reduce the risk of injury, do not allow children to play in or on a dishwasher.
- ◆ Under certain conditions, hydrogen gas may be produced in a hot water system that has not been used for two weeks or more. HYDROGEN GAS IS EXPLOSIVE. If the hot water system has not been used for two weeks, before using the dishwasher turn on all hot water faucets and let the water flow from each for several minutes. This will release any accumulated hydrogen gas. As the gas is flammable, do not smoke or use an open flame during this time.
- ◆ When removing an old dishwasher from service or discarding it, remove the door to the washing compartment.
- ◆ Do not store or use combustible materials, gasoline, or other flammable vapors and liquids in the vicinity of this or any other appliance.
- ◆ Disconnect electrical power to dishwasher before servicing.
- ◆ Repairs should be done by a qualified technician.

CHILD SAFETY TIPS

- ◆ Dishwasher detergents and rinse aids are corrosive, so always keep them out of reach of children.
- ◆ Should a child swallow dishwasher detergent or rinse aid, give plenty to drink immediately, i.e., one or two glasses of milk or water. Do not try to induce vomiting. Seek medical advice immediately: **1-800-POISON1**
- ◆ Always close the door and start the dishwasher as soon as you put in the detergent.
- ◆ Always keep small children away from the machine when it is open. There may be some detergent residue left inside the machine.
- ◆ If dishwasher detergent gets in someone's eyes, rinse them with plenty of water for at least 15 minutes.
- ◆ Do not allow children to use or play in or on the dishwasher.
- ◆ Load all long and sharp items in the knife/utensil basket. If this is not possible, load sharp objects with the pointed end facing the back of the dishwasher. Sharp items loaded in the silverware basket should be loaded with pointed ends down.
- ◆ Engage the child safety lock. (See below.)

ENGAGING THE CHILD SAFETY LOCK

Model D3331 has a child safety lock on the left of the door handle. To activate the lock, press in the door handle and use a screwdriver to turn the screw slot to a vertical position. Reset it by turning the slot to its horizontal position.

To open the door when the safety lock is engaged, press the white plastic tab located to the left of the door handle toward the left and hold it as you lift the door handle. (See illustration at right.)

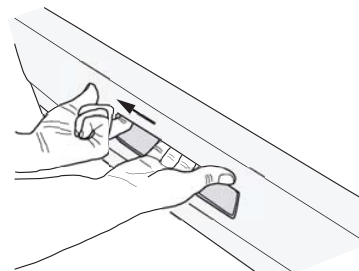

DISHWASHER FEATURES

NOTE: Deviations in features may occur, depending on the model.

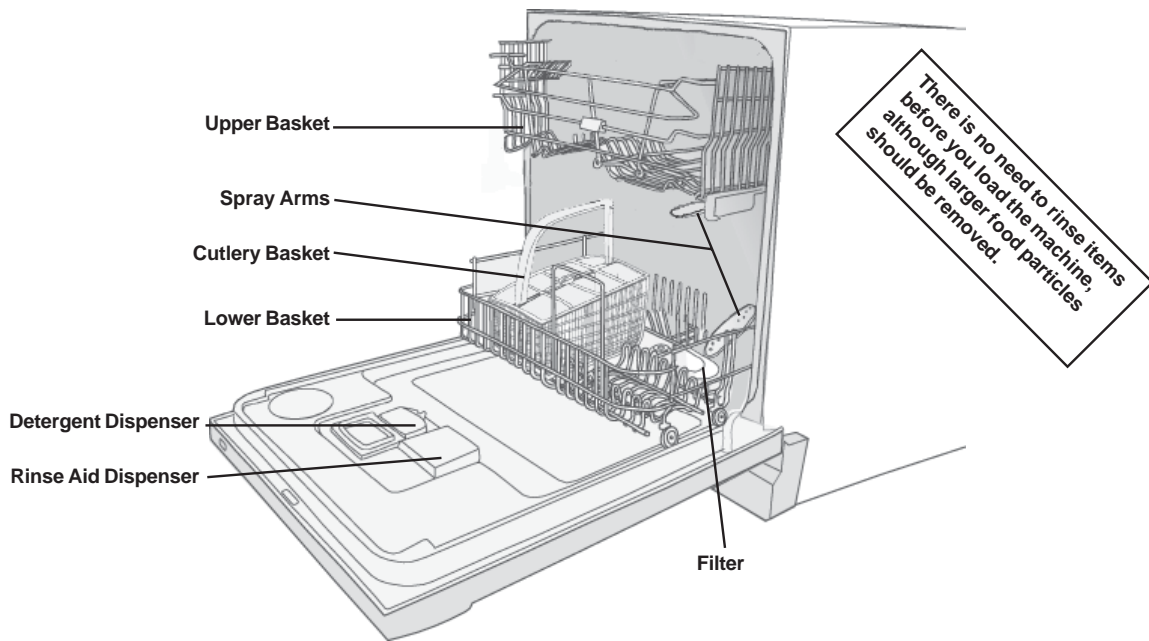

BASKETS

Upper Basket

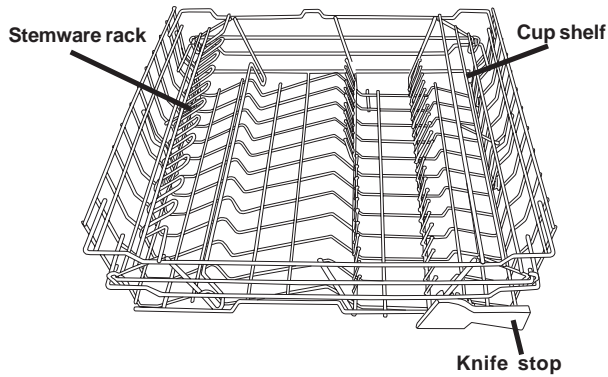

Cutlery Basket

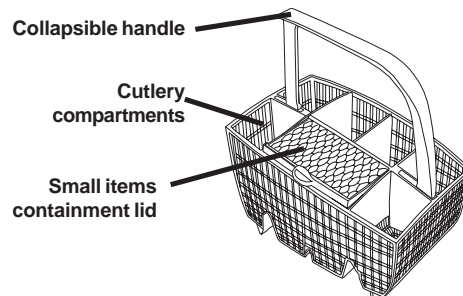

Lower Basket

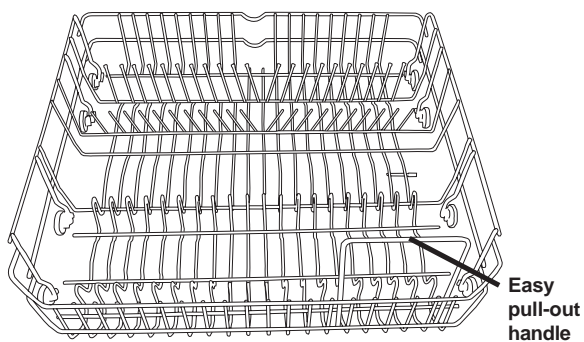

LOADING THE BASKETS

Your new dishwasher features ASKO's Self Cleaning System™. This means that after prewash, mainwash and intermediate rinse the water is drained out and the cycle continues with clean water.

If you plan to start your dishwasher right away, it's not necessary to rinse the dishes. You do, however, need to scrape off the large particles of food before loading.

LOADING THE UPPER BASKET

After you have scraped off the large food particles, place glasses, cups, saucers, bowls and small plates in the upper basket, as illustrated.

Load stemware with the stem fitted inside one of the grooved tines on the stemware rack.

The fold-down cup shelf on the right side of the basket gives you an additional place to stack cups and small bowls. You can also stack cups and small bowls on the stemware rack.

This model has a knife stop on the front of the upper basket. This gives you a safe place to load long utensils and knives that won't fit in the silverware basket. The knife stop prevents knives or utensils from damaging the door when you open and close it.

NOTE: When loading sharp items, always be careful not to cut the rack coating.

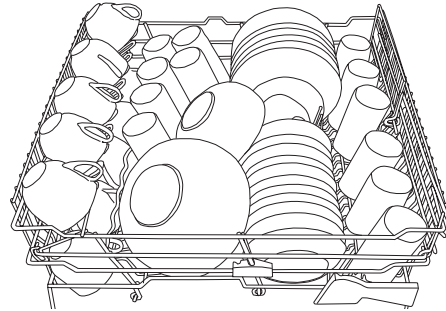

LOADING THE LOWER BASKET

Load larger items in the lower basket, such as, dinner plates, pots and pans, serving dishes, and casseroles. Be sure to load dishware facing downward or toward the center of the dishwasher.

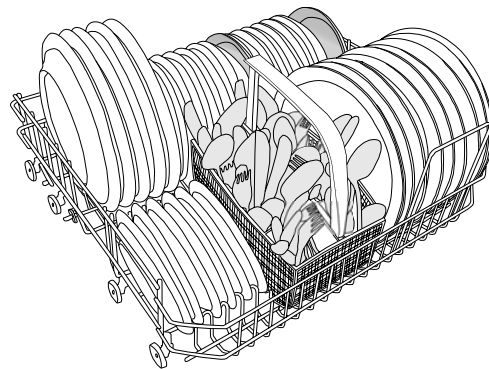

LOADING THE SILVERWARE BASKET

The silverware basket is designed with eight compartments to help keep the silverware separated. Load silverware with the handles downwards and spread it out as much as possible to avoid nesting. For safety, load sharp knives with the handles up.

Avoid placing silverware made of different materials (e.g., silver and stainless) in the same compartment because of the risk of discoloration. (See page 14.)

Small Items Containment Lid

The silverware basket has a lid in the middle that snaps down over the compartments to its left or right to contain small, lightweight items that might slip through the rack tines or get washed out of the basket. The small items lid is slotted, so you also could use it to keep silverware separated, such as teaspoons.

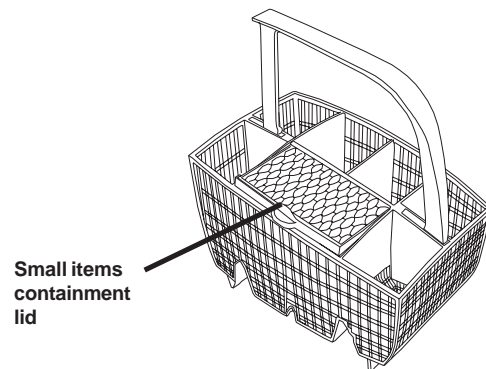

When loading silverware, try to avoid nesting the spoons and forks.

DETERGENT DISPENSER

ASKO dishwashers are designed to be energy efficient. Because the machine uses less water than conventional dishwashers, you also use less detergent and rinse aid. Generally, only one tablespoon of detergent is needed for a normal wash load. The amount of detergent needed for your dishes, however, could be more, depending on the hardness of the water in your area. Also, more heavily soiled items need more detergent. (See below.)

Measure and place detergent for the main wash into the large detergent compartment. The detergent for prewash goes into the small compartment to the right of the main wash compartment. You should use one-half the amount of detergent for the prewash that you use for the main wash. **The amount of detergent used for the main wash and prewash combined should never be over three tablespoons.**

Always add the detergent just before starting the dishwasher, otherwise it could get damp and won't dissolve properly.

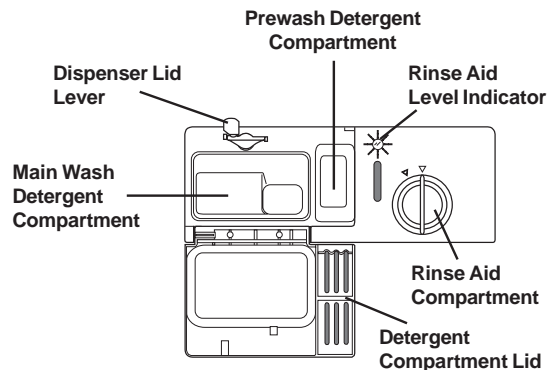

WARNING!

Dishwasher detergent is corrosive! Take care to keep it out of reach of children.

NOTE: We recommend that you do not add prewash detergent for the Delicate or Quick wash programs.

DISHWASHING DETERGENT

We recommend that you use only unscented, granular automatic dishwashing detergent. Using the wrong detergent could cause flooding and/or damage your dishwasher. Do not use detergent that has been wet and is clumped. Also, check the expiration date on the container.

The amount of detergent needed can vary due to differences in water hardness. To determine the water hardness in your area, contact your local water utility or area water softening company. The harder the water, the more detergent you may need. Refer to the chart below for the recommended detergent amounts based on water hardness. Remember, you should adjust the amount of detergent you use by small amounts until you find the correct amount.

NOTE: We recommend that you do not add prewash detergent for the Delicate or Quick wash programs.

NOTE: If you use a dishwashing detergent with a rinse aid additive, you should not fill the rinse aid dispenser. This could cause a film on your dishes.

Twelve grains and higher is extremely hard water and detergent alone may not be enough. You may need to use a water softener to maximize the performance of your dishwasher. Also, in areas with hard water (9+) you may need to wash at lower temperatures to prevent hard water deposits from forming in tank and wash system.

In hard water areas, both the dishes and the machine can develop a white or gray film after a while. This can be removed by replacing the prewash detergent with two tablespoons of citric acid. If the water is very hard, use a rinse aid that contains citric acid.

Different brands of dishwasher detergent have different amounts of phosphorous for softening water. If you have hard water and use a detergent with less than 8.7% phosphorous content, you may need to use more detergent or use a detergent with more than 8.7% phosphorous content.

RECOMMENDED DETERGENT AMOUNTS BASED ON WATER HARDNESS

WATER HARDNESS	DETERGENT AMOUNTS	
Soft (0-3 grains per gallon)	Prewash	1 teaspoon
	Main wash	1 to 1-1/2 tablespoons
Medium (4-8 grains per gallon)	Prewash	1 teaspoon
	Main wash	1 to 2 tablespoons
Hard (9+ grains*)	Prewash	1 teaspoons
	Main wash	2 to 3 tablespoons

* 12 grains and higher is extremely hard water.

RINSE AID DISPENSER

The rinse aid is released during the final rinse to prevent water from forming droplets on your dishes that can leave spots and streaks. It also improves drying by allowing water to “sheet” off the dishes.

ASKO dishwashers are designed to use liquid rinse aids. The rinse aid dispenser is located inside the door next to the detergent dispenser. (See illustration on page 3.) To fill the dispenser, open the cap and pour the rinse aid into the dispenser until the level indicator turns completely black. The dispenser holds about four ounces of liquid rinse aid.

Be careful not to overfill the dispenser, because this could cause oversudsing. Wipe away any spills with a damp cloth. Don't forget to replace the cap before you close the dishwasher door.

If you have soft water, rinse aid may cause a white film to develop on your dishes. You may not need rinse aid.

NOTE: If you use a dishwashing detergent with a rinse aid additive, you should not fill the rinse aid dispenser. This could cause a film on your dishes.

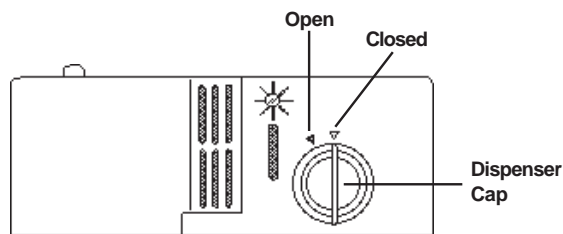

1. To open the dispenser, turn the cap to the “open” (left) arrow and lift it out.
2. Pour the rinse aid into the dispenser, being careful not to overfill.
3. Replace the cap by inserting it aligned with “open” arrow and turning it to the closed (right) arrow.

ADJUSTING THE AMOUNT OF RINSE AID DISPENSED

A measured amount of rinse aid is released during the final rinse. As with detergent, the amount of rinse aid needed for your dishes depends on the hardness of the water in your area. (See page 5.) Too much rinse aid can result in lather or foaming and cause cloudiness or streaks on your dishes. If the water in your area is very soft, you may not need rinse aid. If you do, you can dilute the rinse aid with an equal amount of water.

The rinse aid dispenser has six settings. Always start with the dispenser set on “1.” If spots and poor drying are problems, increase the amount of rinse aid dispensed by removing the dispenser lid and rotating the dial to “2.” If the dishes still aren't drying properly or are spotted, adjust the dial to the next higher number until your dishes are spot-free.

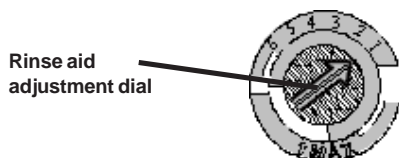

To increase the amount of rinse aid released in the final rinse, turn the adjustment dial to the next higher number.

NOTE: Only adjust the dial one number at a time.

WHEN TO REFILL THE RINSE AID DISPENSER

The black dot on the rinse aid dispenser indicates the amount of rinse aid in the dispenser. As the rinse aid diminishes, the size of the black dot decreases. You should never let the rinse aid get below 1/4 full.

As the rinse aid diminishes, the size of the black dot on the rinse aid level indicator changes, as illustrated below.

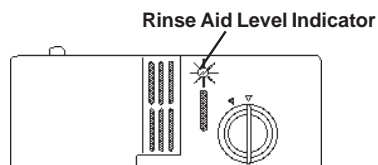

- Full
- 3/4 full
- 1/2 full
- 1/4 full - Should refill to eliminate spotting
- Empty

OPERATING INSTRUCTIONS





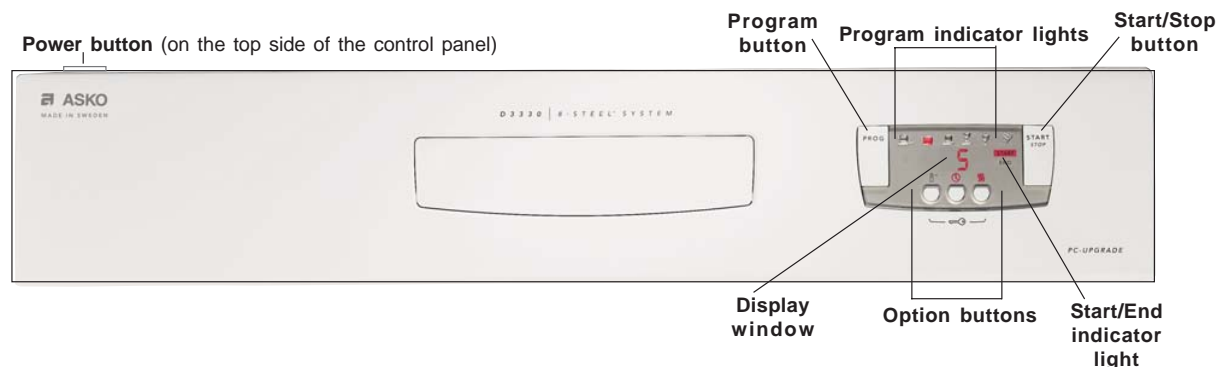

THE CONTROL PANEL

Your ASKO dishwasher has a button-operated control panel, as illustrated below. To select a wash program or option, simply press the Program button until the indicator light for the desired program comes on, press the desired option buttons, then press Start/Stop.



PROGRAMS



To select a program, simply press the program button until the indicator light for the desired program glows. The programs are described below:

-  **Pots and Pans (170°/Sani or 140° F)**
For the heaviest soiled loads, such as casseroles, sauce pans, etc.
-  **Heavy Wash (160° F or 130° F)**
For heavily soiled loads, such as pots, pans, casseroles, etc.
-  **Normal Wash (130° F or 140° F)**
For normally soiled loads, such as plates, glasses, bowls, and lightly soiled pans.
-  **Delicate Wash (105° F or 120° F)**
For delicate items, such as fine china and crystal, that are washed immediately after use. When using this program, you should set the temperature to low and dry the dishes without heat.
-  **Quick Wash (85° F or 120° F)**
For lightly soiled loads that are washed immediately after use. This program can also be used for delicate items, but you should set the temperature to low and dry the dishes without heat.
-  **Rinse and Hold**
To rinse dishes that you plan to wash later that day.

“The Normal Wash program is used for energy testing and should be used for normal or lightly soiled loads. When washing dishes that are more heavily soiled, use a longer program with higher temperatures such as Heavy Wash or Pots and Pans.”

OPTIONS

To select an option, simply press the appropriate option button. The options are described below.

-  **Temperature**
The dishwasher has two temperature options for each wash program, as shown above. When this button is set on the high temperature, the main wash and final rinse are heated to the higher temperature for the selected program. If it is set to low, the main wash and final rinses are heated to the lower temperature. The indicator light will glow only when the *higher* temperature is selected.
-  **Delayed Start**
This button allows you to delay starting the dishwasher from 1 to 12 hours. Press this button until the desired number of hours displays then press Start. If you change your mind before you press Start, continue to press this button until the Delay Start indicator light goes off. The indicator light will glow when Delay Start is selected. To cancel Delay after you press Start, hold down the Start/Stop button for three seconds.
-  **Drying**
This option speeds up the drying process by raising the temperature in the final rinse to 160° F to heat the dishes and tank before the drying cycle begins. The indicator light will glow only when this option is *activated*.

POWER BUTTON ①

Use this button to turn the main power to the unit on and off. Refer to the illustration above to see the location of the power button.

START/STOP BUTTON

Once you have selected the wash program and temperature and drying options, press this button to start the dishwasher. (Make sure the door is securely closed.)

DISPLAY WINDOW

After you press Start/Stop, the display window shows the time it took the program to run last time. (The first time you run a program, a 1 will display.) As the program progresses, the time remaining displays. If the time exceeds an hour, the display alternates between the hour and minutes remaining. The hour is designated by an *h*, e.g., 1*h*).

If you select Delayed Start, the window will display the number of hours selected. It will then display the count-down time until the program starts.

The window also displays fault codes. See below.

INTERRUPTING A PROGRAM TO ADD AN ITEM

If you want to interrupt a program to add an item, open the door slightly until the spray arms stop turning. You can then open the door fully and place the item into the dishwasher. Close the door securely. The program will continue from where it was interrupted.

WARNING! Be extremely careful when opening the door during a program. The water is hot and you could get scalded.

CHANGING OR STOPPING A PROGRAM

If you decide to change the program after you have started the machine, press the Start/Stop button for three seconds. You will have to select the program and options again when you are ready to restart the program. (*Note:* If the program has already gone through the wash cycle, you will have to add detergent.)

PROGRAM TIMES

The program times may not always be the same because of variations in the household hot water temperature. The dishwasher heats the water to the proper temperature for the program selected; so if the temperature of the water entering the dishwasher is too low, the dishwasher will run longer because it takes longer to heat the water. Raising your water heater setting could help to shorten the cycle times.

ACTIVATING THE CHILD-SAFE BUTTON FEATURE

As a safety measure, Model D3331 can be programmed not to start unless the Temperature and Drying buttons are held down simultaneously. To program this feature, follow the steps below:

1. Turn off the power to the machine.
2. Simultaneously press and hold down the Temperature and Drying buttons as you turn on the power to the machine. The Temperature, Drying and Start buttons will flash.
3. Release the buttons.
4. Press the Program button until the display shows 1 with a key symbol alongside it.
5. Press Start to confirm selection and return to main menu.





To deactivate the button lock, simultaneously press the Temperature and Dry buttons. You can then select the program and options and press Start to start the unit. The lock will reactivate automatically in three minutes.

To permanently deactivate the button lock, repeat these steps. When the display shows 0 and key symbol goes out, the button lock has been deactivated.

FAULT CODES

In the event that the machine should fail during a program, the display window will show a fault code. The table below defines these codes and gives possible causes and solutions. See also "Troubleshooting" on page 12.

If you have corrected the fault, turn the main power off then back on to remove the fault indication. If it still displays, try again to correct the problem or call a service technician.

Display	Type of Fault and Recommended Action
	Too much water has entered the dishwasher. Call a service technician.
	Water inlet fault. Make sure the water supply is open.
	Valve leakage. Shut off the water supply and contact a service technician.
	The drain is blocked. See "Troubleshooting" on page 12.
	The filter is clogged. See "Cleaning the Filters" on page 9.

CARE AND CLEANING

The interior of your ASKO dishwasher is made of surgical quality stainless steel that has been electro-polished to make it the smoothest surface available. The smooth surface prohibits the accumulation of dirt and bacteria inside the unit. If the water in your area is especially hard, however, lime deposits could form

inside the machine. If this happens, you can remove them by putting two tablespoons of citric acid in the detergent compartment and running a Normal program. In extremely hard water areas you may need to repeat this process a few times to remove hard water deposits.

CLEANING THE FILTERS

For your convenience, we have placed the drain pump and filtering system within easy reach inside the tub. There are three components of the filtering system: the main filter, the coarse filter, and the fine filter.

In hard water areas, it may be necessary to clean chemical buildup from the filters every 12 to 18 months.

To do this, remove the coarse filter by squeezing the tabs and lifting it out. Next, unscrew the fine filter and lift it and the main filter out. Wash all three filters gently in hot, soapy water and rinse them thoroughly.

WARNING!
Never run the dishwasher without the filters in place.

Main filter

Food and soil particles trapped by this filter are pulverized by a special jet on the lower spray arm and washed down the drain.

Fine filter

This filter holds soil and food residue in the sump area and prevents it from being redeposited on the dishes during a cycle.

Coarse filter

Larger items, such as pieces of bone or glass, that could clog the drain are trapped in the coarse filter. To remove an item caught in this filter, gently squeeze the tabs on top of this filter and lift it out.

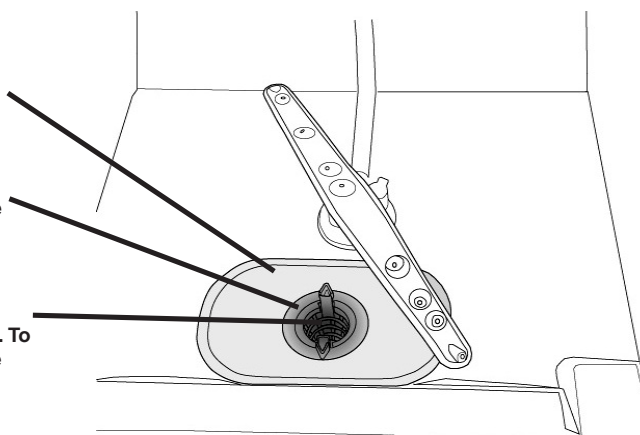

CLEANING THE DOOR

To clean the edge around the door, use only a soft warm, damp rag. To prevent penetration of water into the door lock and electrical components, **do not use a spray cleaner of any kind.**

Also, never use abrasive cleaners or scouring pads on the outer surfaces because they will scratch the finish. Some papers towels can also scratch or leave marks on the surface.

WARNING!

Never use a spray cleaner of any kind on the door panel. You could damage the door lock and electrical components. And never use abrasive cleaners or scouring pads on the outer surfaces because they will scratch the finish. Also, some paper towels can scratch or leave marks on the stainless steel surface.

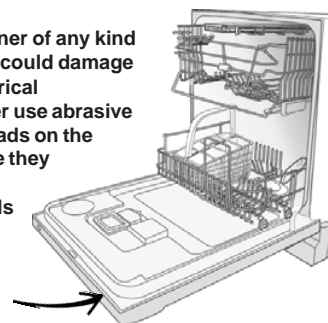

CLEANING THE DRAIN PUMP

On occasion something may get through the filters and into the drain pump. The drain pumps on ASKO dishwashers are designed to automatically reverse if anything should get caught in the propellers, thus ejecting the item back into the sump area or down the drain. Should you need to remove an obstacle from the drain, first turn the power off then remove the filters (as explained on page 9). Next, lift out the adaptor piece on the left side of the sump area. (You might want to remove any standing water first.) You can then look into the sump area for the item causing the obstruction. You may need to use your finger to move the pump blade and loosen the object. Should you find something, simply scoop it out then replace the adaptor piece and the filters.

WARNING!

Never run the dishwasher without the filters in place.

To reach an item caught in the drain pump, remove the filters then the small black insert in the sump area.

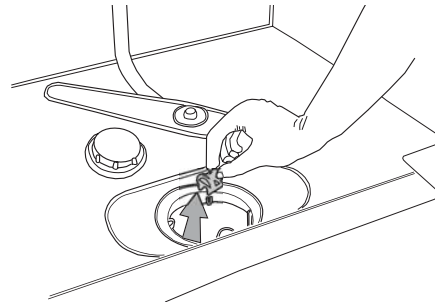

WARNING!

Be sure to replace the adaptor piece before you put the filters back in.

OVERFILL PROTECTION

Your ASKO dishwasher has an overfill protection device that automatically shuts off the inlet valve and circulation pump and starts the drain pump if the water level in the unit should rise above the normal level. If this happens, turn the water off at the main supply and call for service.

If there is water in the base pan due to an overfill or small leak, the water must be removed before the dishwasher will start.

When an overfill is detected, the display window will show a fault message. (See "Fault Codes" on page 8.)

ENERGY SAVING TIPS

- ◆ If you plan to wash the dishes right away, there's no need to pre-rinse. Simply scrape off large particles and load the dishes.
- ◆ Wash only full loads.
- ◆ Use the Pots and Pans and Heavy wash programs only for heavily soiled dishes.
- ◆ Don't use the high temperature for lightly soiled dishes.
- ◆ Select the upper or lower basket option when only one basket is loaded.
- ◆ Use the Express option when washing only slightly soiled loads.
- ◆ Avoid using heat drying. (You can speed up the drying process by opening the door slightly to release the moist air.)

SOLUTIONS TO COMMON DISHWASHING PROBLEMS

As with any new appliance, it sometimes takes using it a few times to learn to operate it properly. If you are having minor performance problems with your dishwasher, read this section before calling for service. It may save you time and unnecessary expense.

NOTE: ASKO has no control over what is put in our appliances once installed in a customer's home. **You are solely responsible for what you wash in your ASKO dishwasher.**

Poor washing performance

- ◆ The dishes may not be loaded properly. Make sure that soiled surfaces are facing downward or toward the center of the dishwasher. Also, make sure that the bowls, pots, etc., are not stacked so closely that water can't reach the soiled surfaces.
- ◆ Make sure you are using the appropriate program settings for the dirtiness of your dishes.
- ◆ An item may be obstructing the spray arm rotation. With the baskets loaded and in place, manually turn the spray arms to make sure they move freely.
- ◆ Your dishwasher detergent should be fresh and stored tightly closed in a cool, dry place. Old or caked detergent will not dissolve properly. Wait until you are ready to start the dishwasher to add the detergent. If you are using the Delay program, make sure the dispenser is dry before adding the detergent.
- ◆ Your dishwasher detergent may be inferior. Try a different brand.
- ◆ Make sure the rinse aid dispenser is filled. (See page 6.)
- ◆ If you have hard water in your area, try adding more detergent and increasing the amount of rinse aid dispensed. (See page 5.)
- ◆ Check that the spray arm jets are not clogged.
- ◆ Do not overload the dishes and be careful to avoid nesting.

Poor drying performance

- ◆ Select the Heat Dry option.
- ◆ If you don't want to use Heat Dry, you can decrease the drying time by opening the door slightly to let out the warm, humid air.
- ◆ Make sure the rinse aid dispenser is filled. (See page 6.)
- ◆ Make sure you use the proper amount of rinse aid. (See page 6.)
- ◆ Load items with concave bottoms tilted so as much water as possible will run off.
- ◆ Unload the bottom basket first to avoid spilling water onto the dishes when unloading the top basket.
- ◆ Certain plastics may need to be towel dried.

Plastic items

- ◆ Always check the manufacturer's suggested care instructions before washing plastic in your dishwasher.
- ◆ Some high-acid foods can discolor plastic. You should rinse these items if you do not plan to run the dishwasher right away.
- ◆ Plastic items dry poorly and may need to be towel dried.

Chipped or Broken Dishes

- ◆ When you load the dishes, be sure they're securely in place and will not fall over or strike against each other during the wash.
- ◆ Load glasses between the tines, not straddling them.
- ◆ Move the baskets in and out slowly to avoid slamming the dishes together.
- ◆ Make sure not to load dishes so high that the spray arms could strike them.
- ◆ Make sure tall glasses and stemware will clear the top of the tub when you push the basket in.
- ◆ Always load delicate items in the top basket.
- ◆ Do not overload the dishwasher.
- ◆ Do not jam the glasses together when loading.

Stains and discolorations

Stains or discoloration on dishes could be caused by a number of things. Listed below are some of the most common causes. See also "Washing Special Items" on page 14.

- ◆ Too much iron or manganese in the water can cause yellow or brown marks on your dishes. As a temporary solution, in place of the prewash detergent, use one teaspoon to one tablespoon of citric acid crystals. You should consider installing a water filtering system.
- ◆ Coffee and tea stains usually have to be removed by handwashing in a solution of 1/2 cup bleach and one quart of water. (Do not use on sterling silver or silver plate.) Be sure to rinse these items thoroughly before putting them in the dishwasher so there is no bleach residue on the dishware.

Etching

If you have a cloudy film on your dishes that can't be removed, it could be etching. To prevent etching, try the following:

- ◆ Use less detergent. You may be using too much for the water hardness in your area. (See page 5.)
- ◆ Use a good quality dishwasher detergent.
- ◆ Do not overload the machine. Water should circulate freely to ensure adequate rinsing and draining.
- ◆ Fill the rinse aid dispenser (unless you have soft water in your area; in which case you may not need a rinse aid.) (See page 6.)
- ◆ Use a lower water temperature setting.
- ◆ Do not use the Heat Dry option.
- ◆ Do not pre-rinse the dishes; just scrape off large food particles and bones.

REMOVING HARD WATER SPOTS FROM DISHES

To remove hard water spots, try the following:

1. Run dishes through a normal wash program.
2. Remove all metal dishware, such as cutlery, pans, etc., from the dishwasher.
3. Do not add detergent.

4. Pour two cups of vinegar into a bowl and set the bowl face up on the bottom rack of the dishwasher.
5. Run the dishes through a Normal wash program.

If this doesn't work, try the same process with 1/4 cup of citric acid crystals (available at most drug stores) instead of vinegar.

TROUBLESHOOTING

If you should experience a problem with your dishwasher, you should review the list of frequently encountered situations below. It could save you the cost and inconvenience of a service call.

Even though the product is under warranty, if the problem is not caused by defective product workmanship or materials, you will be charged for a service call. Refer to page 16 to determine what is and is not covered under your warranty. If you're still not sure, contact the ASKO Advisory Center before you call a service technician.

BEFORE YOU CALL

Before calling for service or contacting ASKO regarding a warranty issue, make a note of the model name, type number and serial number. The model is on the front of the dishwasher. The type plate with the type name and serial number is located on the inside edge of the door. (See illustration at right.)

ASKO Advisory Center Phone Number:
972-238-0794 or 800-898-1879

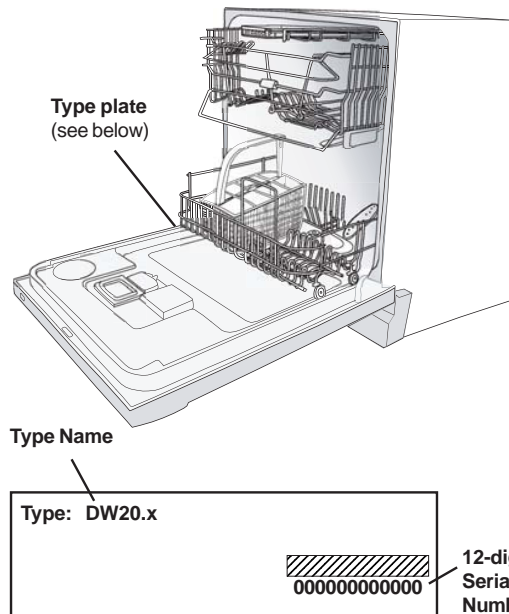

Detergent left in compartment

- ◆ Be careful not to load items so close to the dispenser that the cover will not open to release the detergent.
- ◆ The dispenser is not supposed to open when you use the Rinse program.
- ◆ Your dishwasher detergent should be fresh and stored tightly closed in a cool, dry place. Old or caked detergent should be thrown away because it will not dissolve properly and will leave a gritty residue on the dishware.
- ◆ Wait until you are ready to start the dishwasher to add the detergent.
- ◆ If you are using the Delay program, make sure the dispenser is dry before adding the detergent.
- ◆ The detergent compartment only opens in the main wash programs, not the Rinse program.

Dishwasher makes unusual noises

- ◆ This usually means that something is not loaded properly. Make sure the dishes are securely in place and that nothing has fallen between the basket tines. Also, place small items in the small items compartment and close the lid. (See page 4.)

Dishwasher leaks

- ◆ Use only unscented, granular automatic dishwasher detergent. Using a liquid detergent could cause oversudsing and leakage.
- ◆ You should always use fresh detergent.
- ◆ The amount of detergent needed for your dishes depends on the hardness of the water in your area. Contact your local utility company to learn the water hardness in your area then refer to the chart on page 5 to determine the amount of detergent you should use.
- ◆ Be careful not to overfill the rinse aid dispenser. Spilled rinse aid could cause oversudsing and lead to overflowing. Wipe away any spills with a damp cloth.
- ◆ Make sure the dishwasher is level. (See the installation instructions.)

Dishwasher runs too long

- ◆ If the temperature of the water entering your dishwasher is below 120°, the dishwasher runs longer because it heats the water to the proper temperature for the program selected. Raising your water heater setting may help to shorten the cycle times. If this doesn't resolve the problem, call the ASKO Advisory Center.

Continued on next page.

TROUBLESHOOTING, continued

Dishwasher does not drain properly

- ◆ Make sure that the cycle was complete before you opened the dishwasher. If not, allow it to complete and check again.
- ◆ Some water left in the sump area near the drain is normal.
- ◆ If the plumbing code in your area requires an air gap, make sure that the air gap isn't blocked or plugged.
- ◆ If the unit is connected to a garbage disposer, make sure the disposer is empty.
- ◆ If water backs up into the sink, check the garbage disposer and trap for blockage.
- ◆ Check the dishwasher filters and drain area for blockage. (See page 9.)
- ◆ Check for a kink in the drain hose.

Dishwasher does not fill properly

- ◆ Make sure the water supply is turned on.
- ◆ Make sure the dishwasher is turned on and the door is closed securely.
- ◆ Check for crimps in the water feed line.
- ◆ The system is designed to detect an overflow. When it does, it shuts off the inlet valve and circulation pump and turns on the drain pump. (See "Overfill Protection" on page 10.)

Dishwasher will not start

- ◆ Make sure the dishwasher is turned on and the door is closed securely.
- ◆ Make sure the Delay option is not turned on.
- ◆ Check that the water supply is connected properly and the water is turned on.
- ◆ Make sure the power cord is properly plugged into the wall socket.
- ◆ Check your fuse box for a blown fuse or tripped circuit breaker.

WASHING SPECIAL ITEMS

Most common dishware items can be safely washed in an automatic dishwasher. If you have any doubts about a particular item, check with the manufacturer to see if it is dishwasher safe. If that isn't possible, you might wash one item of a set a few times and compare it to the rest of the set to determine if washing it in the dishwasher

had any affect on it.

NOTE: ASKO has no control over what is put in our dishwashers once installed in a customer's home. **You are solely responsible for what you wash in your ASKO dishwasher.**

Material	Dishwasher Safe	Information and Recommendations
Aluminum	Yes, with caution	Anodized aluminum may fade or darken. Patches and discoloration may appear, but they can be removed with steel wool. Load aluminum utensils (such as a pie tin or roasting pan) where they do not touch other dishes because this can cause gray or black marks. You can remove these spots with a nonabrasive cleaner.
Cast Iron	No	The seasoning is lost and the iron rusts. Hand wash and dry immediately.
China	Yes, with caution	China without decoration or with decoration protected by glaze is dishwasher safe. However, you should arrange the objects so they do not touch each other or they could be damaged. China with a pattern on top of the glaze or with gold leaf decoration may fade. If possible, check with the manufacturer. If that isn't possible, wash one item over an extended period then compare it with the colors and patterns of the rest of the set. Wash in the Quick program on a low temperature setting.
Copper	Yes, with caution	Do not wash copper in the same load as silver or silver plate. It could discolor the silver items. Do not let copper items come in contact with stainless steel.
Crystal	No Yes	Antiques and very delicate china should not be washed in the dishwasher. Certain types of lead crystal may etch if machine washed. Check with the manufacturer. Wash at a low temperature setting. Be sure to load crystal dishware so that it is secure and will not fall over or knock against other dishware while being washed.
Dirilyte	No	Gold-colored flatware can become discolored.
Disposable plastic items	No	Cannot withstand machine washing.
Flatware with bonded handles	No	Certain types of adhesives may loosen when machine washed.
Glass	Yes	<i>Exception:</i> Milk glass may turn yellow.
Knives	No	Sharp kitchen knives may become dull if washed in very hot water and allowed to contact other items during the wash. Wood handles may also warp, crack, or loosen. Plastic handles may discolor. Check manufacturer's washing instructions.
Lead crystal	No	Certain types of lead crystal may etch if machine washed.
Non-dishware items	No	Never wash items such as electronic air cleaners, air filters of any kind, paint brushes, etc. You could damage the dishwasher.
Non-stick coatings	Yes	If marked "Dishwasher Safe." After washing, wipe the non-stick coating area with vegetable oil to maintain its non-stick quality.
Pewter	No	Pewter will tarnish when machine washed.
Plastic	Yes	If the item is labeled "Dishwasher Safe." Do not use heated dry. Do not wash disposable plastic items.
Silver and Silver plate	Yes, with caution	Rinse these items if you're not going to wash them immediately; salty or acidic foods can stain if left on. Dry dishwasher detergent can produce black marks which are difficult to remove. Do not put silver and silver plate in the same silverware basket with stainless steel. Contact between these metals can damage silver. Do not wash copper utensils in the same load. This could cause a brown film on the silver. Also, adhesives used to attach some hollow-handled knives can loosen.
Stainless Steel	Yes, with caution	Rinse these items if you're not going to wash them immediately; salty or acidic foods can stain if left on. Dry dishwasher detergent can produce black marks which are difficult to remove. Do not mix different types of stainless steel in the same load.
Tin	No	Tin will rust.
Wood	No	Unless marked "Dishwasher Safe" by the manufacturer. Wood can warp, crack or lose shape with any kind of washing.

INDEX

A		L	
Aluminum	14	Lead crystal	14
B		Lower basket	3, 4
Baskets	3, 4	M	
C		Main filter	9
Care and cleaning	9	Main wash detergent compartment	5
Cast iron	14	N	
Changing or stopping a program	8	Non-dishware items, washing	14
Child-safe button feature	8	Non-stick pans, washing	14
China	14	O	
Coarse filter	9	Operating instructions	7
Common dishwashing problems	11	Options	7
Control panel	7	P	
Copper	14	Pewter	14
Crystal	14	Plastic items	11, 14
D		Pre-wash detergent compartment	5
Detergent dispenser	3	Program options	7
Detergent left in compartment	12	Program times	8
Dirilyte	14	Programs	7
Dishwasher		R	
does not drain properly	12	Rinse aid dispenser	
does not fill properly	13	filling	6
features	3	setting amount dispensed	6
makes unusual noises	12	S	
runs too long	12	Serial number location	12
Dishwashing problems	11	Service	16
Display window	8	Silver	14
Disposable plastic	14	Silver plate	14
Door, cleaning	9	Silverware basket	3, 4
Drain, problems	13	Small items compartment	3, 4
Drain pump, removing an obstacle	10	Solutions to problems	11
E		Spray Arms	3
Energy saving tips	10	Stainless steel	14
Error codes	8	Stains and discolorations	11
Etching	11	Start/Stop button	7
F		Stemware rack	3
Fault codes	8	Stopping a program	8
Fill problems	13	T	
Filtering system	9	Tin	14
Flatware with custom handles	14	Troubleshooting	12
G		Type plate location on unit	12
Glass	14	U	
H		Unusual noises	12
Hard water	5	Upper basket	3, 4
removing spots	12	V	
I		Warranty information	16
Interrupting a program to add an item	8	W	
K		Wash programs	7
Knife stop	4	Washing special items	14
Knife/utensil basket	3, 4	Water hardness	5
Knives	14	Wood	14

ASKO PRODUCT WARRANTY

MODEL D3331

Be sure to complete the Warranty Registration Card you received with your appliance and mail it to AM Appliance Group to validate your appliance warranty.

Cosmetic damage must be reported to your dealer within five days from the date of purchase. After unpacking the dishwasher, thoroughly check the unit for cosmetic damage.

FOR RESIDENTIAL INSTALLATIONS ONLY

LENGTH OF WARRANTY	AM APPLIANCE GROUP WILL PAY FOR:
<i>Three-Year Full Warranty</i> From date of purchase.	ASKO replacement parts and/or repair labor to correct defect in materials or workmanship. Service must be provided by an authorized ASKO service agent.
<i>Fourth & Fifth Year Limited Warranty</i> Three year full plus fourth and fifth year limited from date of purchase.	ASKO replacement parts (not including labor) for any defective solid-state controls, timers, motors, or pumps as well as defective dishwasher racks – does not include damage due to misuse or abuse. Service must be provided by an authorized ASKO service agent.
<i>Lifetime Warranty</i>	ASKO replacements parts (not including labor) of the stainless steel tank or inner door panel if it fails to hold water due to a manufacturing defect, such as rusting or cracking. Service must be provided by an authorized ASKO service agent.

FOR NON-RESIDENTIAL INSTALLATIONS

<i>Six-Month Full Warranty</i> From date of purchase.	ASKO replacement parts and/or repair labor to correct defect in materials or workmanship. Service must be provided by an authorized ASKO service agent.
--	---

AM APPLIANCE GROUP WILL NOT PAY FOR:

- A. Service calls to:
 - 1. Correct the installation of the appliance.
 - 2. Repair damage due to shipment, delivery, installation, misuse or abuse.
 - 3. Instruct how to use the appliance.
 - 4. Replace house fuses or correct house wiring.
 - 5. Correct house plumbing, including drain problems related to improper installation. (High loop, disposer knockout, disposer not draining, etc.)
 - 6. Clean or service air device in drain line.
- B. Repair and/or replacement parts for failure of product if appliance is used for other than home/residential use.
- C. Damage resulting from accident, fire, floods, acts of God, alteration, misuse, abuse, improper installation, or installation not in accordance with local electrical or plumbing codes.
- D. Any shipping costs for parts during the limited warranty period.
- E. Replacement parts or repair labor costs for units operated outside the Continental United States.
- F. Pickup and delivery. ASKO washers are designed to be repaired in the home.

IN NO EVENT SHALL AM APPLIANCE GROUP BE RESPONSIBLE FOR ANY INCIDENTAL OR CONSEQUENTIAL DAMAGES.

Some states will not allow the exclusion or limitation of incidental or consequential damages, so this exclusion or limitation may not apply to you. This warranty gives you specific legal rights and you may also have other rights which vary from state to state.

For warranty service, contact the dealer from whom you purchased the unit or an authorized ASKO service agent. Service will be provided during normal business hours. Should you have a service problem that cannot be resolved locally, contact AM Appliance Group at the numbers listed below. Before calling for service or contacting AM Appliance Group regarding a warranty issue, make a note of the model, type name, and serial number (see page 12).

AM Appliance Group
P. O. Box 851805
Richardson, Texas 75085-1805

ASKO Advisory Center
800-898-1879
or 972-238-0794