

This Owner's Manual is provided and hosted by [Appliance Factory Parts](#).



COMFORT-AIRE PTHP15F130ASC Owner's Manual

[Shop genuine replacement parts for COMFORT-AIRE
PTHP15F130ASC](#)



[Find Your COMFORT-AIRE HVAC Parts - Select From 1486 Models](#)

----- Manual continues below -----

Comfort-Aire®

Century®

MARS
Delivering Confidence

Owner's Manual

Packaged Terminal Air Conditioners & Heat Pumps

7,000-15,000 BTUH

7,000-15,000 BTUH

Cooling w/Electric Heat

PTAC07F130A
PTAC09F130A
PTAC12F130A
PTAC12F150A
PTAC15F130A
PTAC15F150A

Cooling w/Electric Heat

with seacoast coating

PTAC12F130ASC
PTAC12F150ASC
PTAC15F130ASC
PTAC15F150ASC

Heat Pump with Electric Heat

PTHP07F130A
PTHP09F130A
PTHP12F130A
PTHP12F150A
PTHP15F130A
PTHP15F150A

Heat Pump with Electric Heat

with seacoast coating

PTHP12F130ASC
PTHP12F150ASC
PTHP15F130ASC
PTHP15F150ASC

CONTENTS

UNIT FEATURES	3
INSTALLATION INSTRUCTION.....	5
WIRING	8
OPERATING INSTRUCTIONS (Accessory Optional).....	9
MAINTENANCE AND CLEANING.....	11
NORMAL OPERATING SOUNDS AND CONDITION.....	13
DIAGNOSTIC CODES	13
TROUBLE SHOOTING	14

IMPORTANT NOTES:

Before using this manual, check the serial plate for proper model identification.

The installation and servicing of this equipment must be performed by qualified,experienced technicians only.

Due to policy of continual product improvement, the right is reserved to change specifications and design without notice.

IMPORTANT NOTE TO THE OWNER

The service portion of this manual is to be used by qualified,professionally trained HVAC technicians only. The manufacturer does not assume any responsibility for property damage or personal injury for proper service procedures or services performed by an unqualified person.

IMPORTANT NOTE TO THE SERVICER

Read this manual and familiarize yourself with the specific items which must be adhered to before attempting to service this unit. The precautions listed in this Installation Manual are intended as supplemental to existing practices. However, if there is a direct conflict between existing practices and the content of this manual, the precautions listed here take precedence.

THE FOLLOWING WARNINGS ARE VERY IMPORTANT FOR SAFETY. PLEASE READ THEM CAREFULLY BEFORE INSTALLATION!

1. This air conditioner must be installed by a qualified installer.
2. Please insure that there is an available ground in the power supply system before installation.
3. To avoid electric shock or death, the socket or terminal blocks for power supply to the air conditioner(include 277V and 115V and 208-230V series and the units that have LCDI power cord) must have a Ground Fault Circuit Interrupter.
4. During installation, do not cross connect or reverse L1 and neutral. Please be sure the ground wire is firmly connected otherwise it is possible to result in electrical shock or death.

RECOGNIZE THIS SYMBOL AS A SAFETY PRECAUTION



WARNING

THE MANUFACTURER WILL NOT BE RESPONSIBLE FOR ANY INJURY OR PROPERTY, DAMAGE ARISING FROM IMPROPER SERVICE OR SERVICE PROCEDURES. IF YOU INSTALL OR PERFORM SERVICE ON THIS UNIT, YOU ASSUME RESPONSIBILITY FOR ANY PERSONAL INJURY OR PROPERTY DAMAGE WHICH MAY RESULT, MANY JURISDICTIONS REQUIRE A LICENSE TO INSTALL OR SERVICE HEATING AND AIR CONDITIONING EQUIPMENT.



WARNING

**HIGH VOLTAGE
DISCONNECT ALL POWER BEFORE SERVICING OR INSTALLING THIS UNIT. MULTIPLE POWER SOURCES MAY BE PRESENT, FAILURE TO DO SO MAY CAUSE PROPERTY DAMAGE, PERSONAL INJURY OR DEATH**

UNIT FEATURES

This unit has many features which are different than those found on conventional PTAC units. The servicer must be familiar with these features in order to properly handle the unit.

- **LCDI Cords** - Underwriters Laboratories and the National Electric Code (NEC) now require power cords that sense current leakage and can open the electrical circuit to the unit on units rated at 250 volts or less. In the event that unit does not operate, check the reset button located on or near the head of the power cord as part of the normal troubleshooting procedure.



LCDI power Cord

- **Automatic 3-minute compressor lockout** - After the compressor cycles off, it will not restart for three minutes.
- **Random restart delay** - To help eliminate power surges after a power outage, the unit is equipped with a two to four minute random restart delay feature. Whenever the unit is plugged in with the master switch turned on and the mode switch set in the cool or heat mode, a random restart will occur.
- **Indication LEDs** - The control panel has LEDs that correspond to fan operation and to indicate unit status. The LEDs next to the selections ON/OFF, FAN, COOL, and HEAT indicate which operational mode is active.

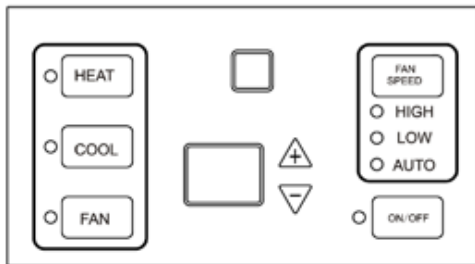

- **High Pressure Protection** - The unit will shut off automatically when the pressure in the system is over 638 psi and within 10 minutes, after the compressor turns off, the unit will restart when the pressure turns back below 551 psi. This protection can effectively avoid the burst and leakage of pipes, lessen the system failures and prolong the service life.
- **Failure Tolerance** - If the unit is in protection mode less than 4 times in one hour, the accumulation times will reset to avoid system failure. Only when the unit enters protection mode more than 4 times in one hour will the system fail to restart automatically and need manual restart.

- **Standard Physical Dimensions** - The series PTAC uses standard dimensions, 42" wide x 16" high x 13-3/4" deep. Replacement of older units is made easy.

- **Weather - Protected Electrical Components** - Vital electrical components are protected from the weather by locating them on the indoor side of the weather barrier.

- **Highly Featured Microprocessor Controls** - Microprocessor controls are programmed to interface with the temperature sensors to maximize comfort conditions for the room occupant. Thermistors are used to sense small changes in temperature to give excellent room control and allow the microprocessor to monitor and react to changing conditions.

- **Automatic Emergency Heat on Heat Pump Units** - Automatically uses electric resistance heat if the heat pump falls.

- **High-Temperature Heat Pump Operation Protection** - Automatically protects the compressor if heat pump is operated with high indoor coil temperatures. Power to the outdoor fan and the compressor are turned off if the indoor coil gets too hot during heat pump operation to prevent damage to the compressor.

- **Fan Motors Permanently Lubricated** - All units have two fan motors for quiet operation and maximum operating efficiency. Motors are permanently lubricated to reduce maintenance and totally enclosed to keep dirt and water out of the motor windings.
- **Indoor Fan Speed Selections LOW /HIGH/AUTO** - Unit may be operated in low, high or auto fan speeds. Some speeds may not be present based on unit capacities.
- **Rotary Compressor** - smoother operation for quiet, dependable service and high efficiency.
- **Indoor Coil Frost Control** - prevents indoor coil from freezing. Frost can form on the Indoor coil when the unit is operated in cooling when the outdoor temperature is low. The unit automatically shuts the compressor off until the indoor coil temperature warms to the point where frosting will no longer occur, then restarts the compressor.
- **LS Control (front-desk control)** - The unit can be turned ON/OFF by a front desk control switch. The control wire, colored purple, locates in the wall mounted thermostat interface (refer to Fig. 7 on page 8).
The control logic as below:
 1. Turn ON unit: short circuit R and LS then release one time within 5 seconds.
 2. Turn OFF unit: short circuit R and LS then release for twice within 5 seconds.
 3. Force unit shut down for one time: connect LS to R for over 5 seconds and then release.

NOTE: After force shut down, you can turn the unit ON again by hand-held remote controller or the control panel.
- **Special control functions for DIP switches** - The DIP switches are on main board.
 - NO.4-Heating priority
ON-Heat pump to be prior,
OFF-Electric heat to be prior.
 - NO. 5-Auto heating (for units with heat). When unit is connected to the power supply, and room temperature is lower than 10°C/50°F for 3 minutes, unit will start heating automatically no matter what the setting mode is. Only when room temperature reaches 13°C/55°F will heating stop. ON position enables this function.

NO. 6 -Electric Power-off Memory. After power on, the unit will run the same settings as last time. ON position enables this function.

NO. 7-Fan CON/CYC for heating.
ON position enables continuous fan for heating. The default setting is fan cycled for heating.

NO. 8 -Fan CYC/CON for cooling ON position enables fan cycle for cooling. The default setting is fan continuous for cooling.

WARNING: Before service, you must disconnect the power cord to avoid electric shock! Do not reprogram DIP switches No. 1 to No. 4, when powered this could cause damage or fire. Power the unit on again, the new function will be activated.

WARNING

**HIGH VOLTAGE
DISCONNECT ALL POWER BEFORE SERVICING
OR INSTALLING THIS UNIT. MULTIPLE POWER
SOURCES MAY BE PRESENT,FAILURE TO DO SO
MAY CAUSE PROPERTY DAMAGE,PERSONAL
INJURY OR DEATH.**

UNIT ACCESSORIES

This unit is designed for through-the-wall installation in new or existing buildings. To complete the installation of this PTAC, an insulated wall sleeve and an outdoor grille (either the stamped aluminum grille, or the architectural grille) are required. Consult with your distributor to acquire any optional accessories.

The chassis and the cabinet front are shipped in one carton.

INSTALLATION INSTRUCTIONS

To ensure that the unit operates safely and efficiently, it must be installed, operated and maintained according to these installation and operating instructions and all local codes and ordinances or, in their absence, with the latest edition of the National Electric Code (or CEC for Canadian Installations). The proper installation of this unit is described in the following sections. Following the steps in the order presented should ensure proper installation.

⚠ WARNING

**HIGH VOLTAGE
DISCONNECT ALL POWER BEFORE SERVICING
OR INSTALLING THIS UNIT. MULTIPLE POWER
SOURCES MAY BE PRESENT, FAILURE TO
DO SO MAY CAUSE PROPERTY DAMAGE,
PERSONAL INJURY OR DEATH.**

⚠ WARNING

**REMOVE FRONT PANEL, DO NOT DIRECTLY
TOUCH THE FIN.**

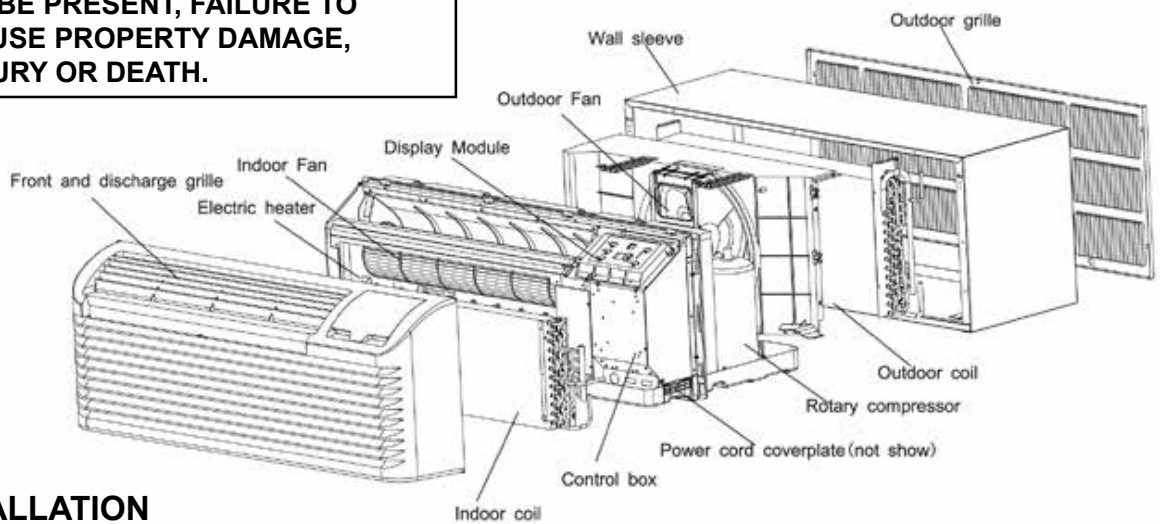

SLEEVE INSTALLATION

Wall sleeve location

When making the wall opening, please observe the following requirements:

- A) The air inlet and outlet should be unblocked so the air can be delivered to every corner of the room.
- B) Install the unit in places that are away from heat or sources of flammable gases.
- C) Do not install the unit in places that are subject to heavy dust.
- D) Do not install the unit in places where the operational noise and exhausted air might trouble your neighbor.
- E) There should be sufficient space around the unit to facilitate maintenance and repairs (refer to Figs. 1 and 2).



Fig. 1



Fig. 2

Dimension	Recommended installation clearance
D1	Projection of case into room - 1/2" minimum up to 1-3/4" maximum without use of electrical sub-base. Note: 2-3/8" minimum when sub-base is used.
D2	Height above finished floor or top of carpet - 1/2" minimum 2" recommended without sub-base - 3" minimum with sub-base.

Preparation of the Wall

The sleeve should be installed during construction and lintels should be used to support the block above the wall sleeve. The sleeve can not support the load of bricks/ blocks.

For existing construction, wall opening must be created, the proper dimensions are necessary to avoid use of fillers or additional framing. The sleeve is modular in height and width (refer to Fig. 3 & Chart 2).

Height:

Fits 2 courses concrete block

Fits 6 courses standard brick

Fits 5 courses jumbo brick

Width: Fit approximately 3 stud spaces.



Fig. 3

Chart 2

Minimum Finished Opening Dimensions		Approximate Sleeve Dimensions		
Height	Width	Height	Width	Depth
16-1/4"	42-1/2"	16"	42"	13-3/4"

Note: Sleeves may vary slightly by manufacturer. Ensure that the unit fits the sleeve before installation.

In order for condensate water to drain properly inside the unit, the sleeve must be installed properly:

- Level from right to left.
- A slight downward pitch from the indoor side to the outdoor side as shown below Fig. 4).
- Fasten the wall sleeve (Fig. 5).

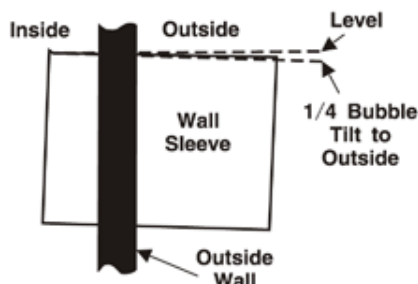

Fig. 4 Proper Sleeve Tilt



Fig. 5

OUTDOOR GRILLE (OPTIONAL ACCESSORY)

An outside grille must be installed to direct air flow for proper unit operation and also protect the outdoor coil. The grille must be installed before installing the chassis. When replacing an old chassis with an existing grille or using a specialized grille in a new installation, please check with after-sales engineer of supplier to determine if the new chassis should be used with the nonstandard specialized grille. An improper outdoor grille can decrease cooling or heating capacity, increase energy usage and shorten compressor life and possibly void the warranty.

STAMPED ALUMINUM GRILLE



ARCHITECTURAL GRILLE

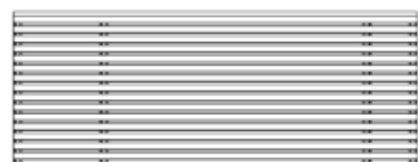

CHASSIS INSTALLATION

1. Remove the cabinet front from the chassis as described in Front Removal.
2. Insert the chassis into the wall sleeve.

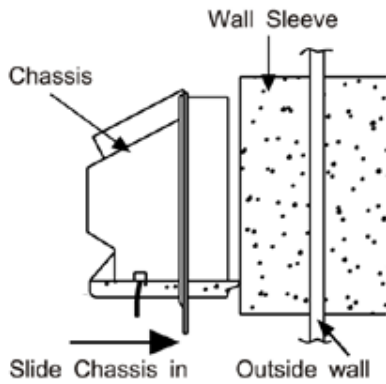

Chassis Installation View 1

3. Slide the chassis into the wall sleeve until the chassis flanges contact the front edge of the wall sleeve.



Chassis Installation View 2

4. Secure the chassis to the wall sleeve using two screws on each side of the chassis to ensure a proper seal between the chassis and the wall sleeve. The screws are supplied in a plastic bag.

IMPORTANT NOTES:

1. The unit is equipped with a rubber grommet mounted compressor. These grommets are factory set and require no adjustment.
2. Check the indoor and outdoor grilles for obstructions to air flow. The unit must be located where curtains, furniture, trees, or other objects do not block the air flow to and from the unit. If air is obstructed and/or deflected back into the unit, the air conditioner compressor may cycle on and off rapidly. This could damage the compressor or possibly void the warranty.

FRONT REMOVAL

1. Grasp the cabinet front.

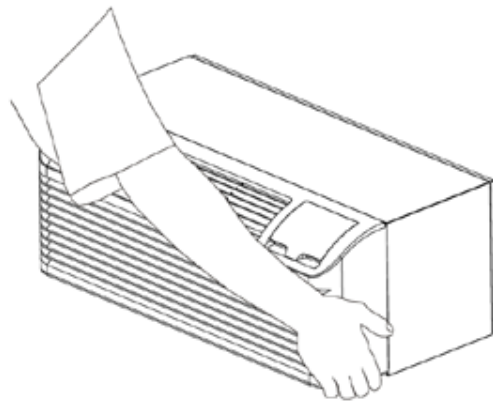

Cabinet Front Removal View 1

2. Pull the bottom of the cabinet front away from the chassis until the retaining clips disengage.

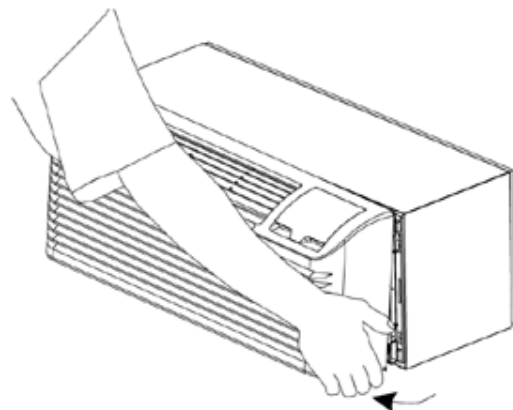

Cabinet Front Removal View 2

3. Lift the cabinet front off the chassis. Reverse this procedure to reinstall the cabinet front.

WIRING

Cord connection to a wall socket is not permitted for 265V units. All 265V units must be hard wired using the hard wire kit or make use of the plug in receptacle in the standard subbase.

230~208V units are equipped with LCDI power cords and can open the electrical circuit to the unit. In the event the unit does not operate, check the reset button located on or near the head of the power cord as part of the normal procedure.

WARNING

HIGH VOLTAGE
 DISCONNECT ALL POWER BEFORE SERVICING OR INSTALLING THIS UNIT. MULTIPLE POWER SOURCES BE PRESENT, FAILURE TO DO SO MAY CAUSE PROPERTY DAMAGE, PERSONAL INJURY OR DEATH. DO NOT SERVICE THIS UNIT WITHOUT FIRST SHUTTING OFF THE POWER TO THE UNIT FROM THE CIRCUIT BREAKER AND/OR REMOVING THE UNIT CORD SET PLUG FROM THE WALL OUTLET.

WARNING

TO AVOID THE RISK OF PROPERTY DAMAGE, PERSONAL INJURY OR FIRE, USE ONLY COPPER CONDUCTORS.

WARNING

TO AVOID THE RISK OF PROPERTY DAMAGE, PERSONAL INJURY OR DEATH DUE TO ELECTRICAL SHOCK, DO NOT USE AN EXTENSION CORD WITH THIS UNIT.

WARNING

TO AVOID THE RISK OF PROPERTY DAMAGE, PERSONAL INJURY OR FIRE. DO NOT INSTALL WITH POWER CORD STRETCHED OR UNDER A STRAIN AS THIS MAY CREATE LOOSE PLUG/RECEPTACLE CONNECTION.

WARNING

TO AVOID THE RISK OF PERSONAL INJURY, WIRING TO THE UNIT MUST BE PROPERLY POLARIZED AND GROUNDED.

WARNING

THIS AIR CONDITIONER IS NOT MEANT TO PROVIDE UNATTENDED COOLING OR LIFE SUPPORT FOR PERSONS OR ANIMALS WHO ARE UNABLE REACT TO THE FAILURE OF THIS PRODUCT. THE FAILURE OF AN UNATTENDED AIR CONDITIONER MAY RESULT IN EXTREME HEAT IN THE CONDITIONED SPACE CAUSING OVERHEATING OR DEATH TO PERSONS OR ANIMALS.

VOLTAGE MEASUREMENTS

Once the unit is properly wired, measure the unit supply voltage. Voltage must fall within the voltage range given in Chart 3.

Operating Voltage		
Unit Voltage	Voltage Utilization Range	
Rating	Minimum	Minimum
230/208	187	253
265	238	292

Chart 3 - Operating Voltage

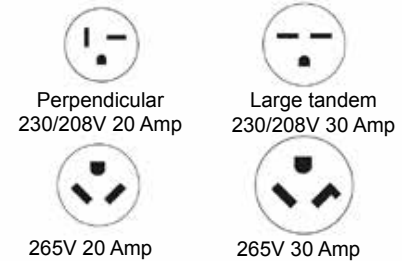
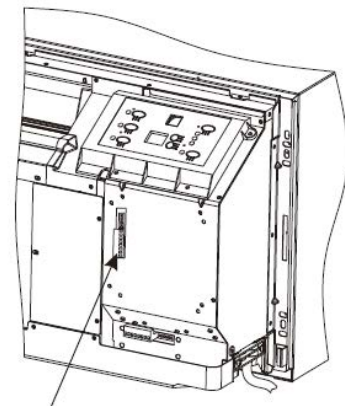
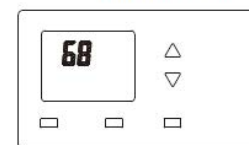
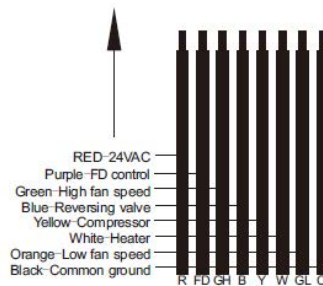
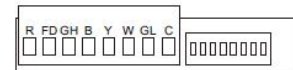

Fig. 6 Receptacles / Sub-bases



WALL MOUNTED THERMOSTAT INTERFACE



Thermostat

Fig. 7 wall mounted thermostat wiring

NOTE: See the "Remote Thermostat Change" Instructions before using the thermostat.

OPERATING INSTRUCTIONS



Fig. 8 Use of unit mounted control panel

COOL / FAN / HEAT MODE OPERATION PROCEDURE

Control panel:

- Press the ON/OFF button.
- Press the HEAT/COOL/FAN button, select the operation mode: heat/cool/fan.
- Press + or - button, to set your desired temperature. The setting temperature range is 60-90°F (16-32°C).
- Press the FAN SPEED button, to set your desired air flow rate: high/low/auto.

TIMER PROCEDURE (Remote controller)

When batteries are inserted, the present time is automatically set to AM 0:00.E.X.:set to AM10:30.

- Open the back cover,push the CLK button .The time Indicator is flickering and can set the present time.
- Press the HOUR button.(set to AM 10:00)
- Press the MIN button. (set to 30)
- Press the CLK button again, and then close the back cover.

SET UP OPERATION

- 1) Temperature shift key: Press + and - button at the same time for 3 seconds, the temperature is shifted between Fahrenheit and centigrade.
- 2) Temperature setting limiting: Press + and SPEED button at the same time to enter the maximum and minimum temperature setting. R1~R8 will be displayed every 3 seconds. Release the two keys to ensure the setting is effective and the figures will last for 5 seconds. The temperature setting range is between 60°F ~90°F as factory default.

Chart 4. Temperature setting limiting

R1	R2	R3	R4	R5	R6	R7	R8
Heating Temperature Limits (°F)							
86	86	90	74	92	90	72	90
Cooling Temperature Limits (°F)							
63	65	72	72	67	69	68	60

- 3) **Remote thermostat change:** In standby off mode, press HEAT and+ button, for 3 seconds, the buzzer will chime and LED display will read "P" or "r".
P: unit control panel has control of unit.
r: wall thermostat has control of unit.

VENTILATION CONTROL

The ventilation control lever is located at left side of unit, behind front panel.

NOTE: The vent door shipping tape must be removed before using vent control lever. See Fig. 9 and Fig. 10.

When set to closed, only the air inside the room is circulated and filtered;

When set to open, some outdoor air will be drawn into room, this will reduce heating or cooling efficiency.

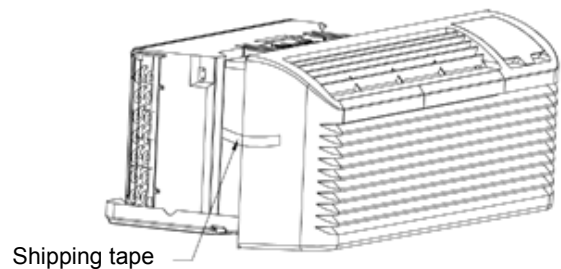

Fig. 9 Shipping Tape Location

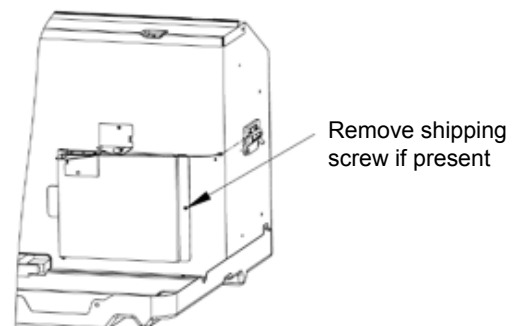

Fig. 10 Shipping Screw Location

The vent control allows outside air to be drawn into the conditioned area. This outside air can provide ventilation when the blower is operating, but it will increase the heating or cooling load and operating costs.

To obtain access to the vent control

1. Remove the cabinet front (see Front Removal).
2. Remove the shipping screw (if installed) from the vent door.
3. Remove the label (if present) from over the vent control lever on the left side of the chassis. Remove the vent door shipping screw.
4. Rotate the vent control lever to either open or close the damper.

⚠ WARNING

HIGH VOLTAGE
DISCONNECT ALL POWER BEFORE SERVICING OR
INSTALLING THIS UNIT. MULTIPLE POWER SOURCES
MAY BE PRESENT, FAILURE TO DO SO MAY CAUSE
PROPERTY DAMAGE, PERSONAL INJURY OR DEATH.



Vent door lever positions

AIR DISCHARGE GRILLE

The discharge grille can be adjusted to expel air at either a 15° or 55° angle.



Discharge Grille Orientation Options

Use the following procedure to change the angle of the discharge air flow:

1. Remove the front cabinet (see Front Removal).
2. Position the front so that the backside is accessible.

Discharge Air Flow

3. Remove the seven (7) screws which secure the discharge air grille to the cabinet front.

Location of 7 Screws



Discharge Air Flow Grille Removal

4. Rotate the grille 180° clockwise
5. Reinstall the screws securing the discharge air grille to the cabinet front. Reinstall the cabinet front on the unit.

MAINTENANCE AND CLEANING

⚠ WARNING

HIGH VOLTAGE
DISCONNECT ALL POWER BEFORE SERVICING OR
INSTALLING THIS UNIT. MULTIPLE POWER SOURCES
MAY BE PRESENT, FAILURE TO DO SO MAY CAUSE
PROPERTY DAMAGE, PERSONAL INJURY OR DEATH.

MONTHLY MAINTENANCE AND CLEANING

Intake Air Filters

To properly maintain the operational performance of your PTAC unit, it is extremely important that the inlet air filters be cleaned once per month or more often if operated in dusty or dirty locations or conditions. The intake air filters are constructed of durable polypropylene. The "air intake" air filters can be easily inserted into the cabinet front, using the filter guides. Before cleaning the intake filter, turn the unit off by setting the mode switch to the OFF position. Filter should be cleaned as required.

The following procedure is used to remove the intake filter:

1. Grasp each filter by its molded handle, located on the front edge of the front, below the discharge grill.

2. Pull the filter straight up and remove.
3. Clean filter with vacuum or with running water.
Reverse this procedure to reinstall the filter.

Filter is removed by grasping the filter's top and gently pulling up

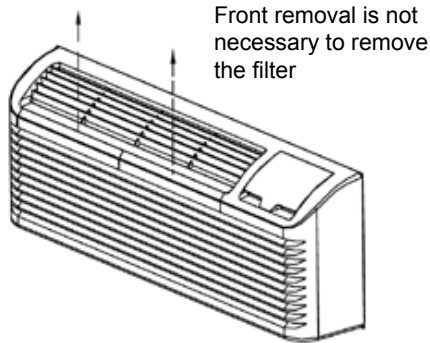

Vent Screen

Before cleaning the vent screen, disconnect power to the unit by unplugging the power cord at the wall outlet or subbase, or disconnect power at the fuse box or circuit breaker. If unit is operated with vent door closed, the vent screen does not need to be cleaned.

1. Remove the cabinet front as described in Front Removal.
2. Remove the four screws securing the chassis to the wall sleeve.
3. Slide the chassis out of the wall sleeve far enough so that the vent screen is accessible.
4. Clean the vent screen, slide the chassis back into the wall sleeve, secure it in place with four screws and reinstall the front cabinet.

Cabinet Front

The cabinet front and discharge air grille can be cleaned with a water dampened cloth. Under no circumstances should hydrocarbon-based cleaners (e.g. acetone, benzene, naphtha gasoline, etc.) or ammonia based cleaners be used to clean the front or air grilles. Use care when cleaning the control area.

YEARLY MAINTENANCE AND CLEANING

NOTE: Use a mild biodegradable detergent when cleaning the unit. Special care must be taken to protect the unit's control board and other electrical components from getting any water on them while cleaning. The use of harsh or caustic cleaning agents or materials such as bleach or coil cleaners that are not designed for PTAC products will cause damage or deterioration of the aluminum fin or coil material and is not recommended. Care must be taken not to bend the aluminum fin stock.

Routine scheduled Maintenance

To achieve continuing top performance and high efficiency, establish a "once a year" cleaning/inspection schedule for the unit. Take the unit out of the sleeve and thoroughly clean and rinse. Be sure to include in the yearly cleaning the evaporator coil, and condenser coil, basepan, and drain passages.

Scheduled maintenance can be accomplished by either qualified local maintenance staff or by an authorized servicer. They must follow the instructions described in this manual.

Adverse Operating Conditions Maintenance

Units operating in dusty or corrosive locations; i.e. dusty construction site or sea coast, must be cleaned more often. A minimum of four (4) times a year will maintain proper operational conditions and protect unit components.

Wall sleeve

Clean the wall sleeve while cleaning the unit. The caulking around the sleeve should be checked to make sure that any potential air and water openings around the sleeve are properly sealed. The wall sleeve's level should also be rechecked. Proper leveling for most installations are a 1/4 bubble tilt to the outside and level from right to left. Contact your sales person for detailed maintenance or cleaning instructions.

CAUTION

DO NOT USE COMMERCIAL GRADE COIL CLEANERS. SOME OF THESE CLEANERS MAY CONTAIN ETHYLENE DIAMINE TETRACETIC ACID (EDTA) WHICH CAN SHORTEN THE LIFE OF THE CONDENSER COIL.

Base pan and Condenser coil

Before cleaning the base pan and condenser coil, turn OFF unit mode switch and disconnect power to the unit. To disconnect power, disconnect power at the fuse box or circuit breaker.

1. Create a water tight seal by tightly covering the entire control panel area and fan motor with plastic. Creating this seal prevents water from entering the control area or the fan motor and damaging the unit.
2. Spray condenser coil and base pan down with water.
3. Rinse condenser coil and base pan with water again.
NOTE: Ensure water pressure is no higher than that of an ordinary garden hose and the water temperature no higher than 120°F.

4. Tilt the non-compressor side of the unit up no higher than 45 degrees and allow water to drain out the other side of the unit.
5. Remove excess water left in the base pan by wiping the base pan with a dry cloth.
6. Remove the water-tight seal from the motor and control panel area.
7. Reinstall unit back into wall sleeve.
8. Allow unit to dry for 24 hours before reapplying power. When power is reapplied test unit for proper operation.
9. Place a non-acidic algaecide in the base pan to inhibit bacteria growth. Ensure the algaecide is compatible with wet coil operation and is not corrosive to the coil.



CAUTION

HIGH PRESSURE AND HIGH TEMPERATURE CLEANING IS NOT RECOMMENDED. DOING SO COULD DAMAGE THE ALUMINUM FIN STOCK AND ELECTRICAL COMPONENT.

Clearance Check

Clearances around the unit should also be checked to make sure that the intake air and discharge air paths have not become blocked or restricted. A minimum of eight inches clearance is needed from unit to furniture, beds, or other objects for proper operation. Restricted discharge or intake air will reduce the unit's operational performance. In severe airflow restrictions, damage can occur to unit components such as the compressor, electric heater or fan motor.

NORMAL OPERATING SOUNDS AND CONDITIONS

Water trickling sounds

Water is picked up and distributed over the coil. This improves the efficiency and helps with water removal.

Water dripping

Water will collect in the base pan during high humidity days. This can cause overflow and drip from the outside of the unit.

Air sounds

The fan cycle switch sets the operational mode of the fan. In the ON position the fan will run continuously whenever power is applied in this mode. In the AUTO position, the fan will cycle on and off with the compressor or electric heater.

Starting delay

You may notice a few minutes delay in the starting if you try to restart the unit too soon after turning it off or if you adjust the thermostat right after the compressor has shut off. This is due to a built-in delay to protect the compressor.

Buzzer Response

The buzzer will chime (0.1 sec) as response when receiving an order from key pad control and remote control.

DIAGNOSTIC CODES

The Diagnostic Maintenance provides detailed information on PTAC control operation and operational status including present modes, failures, airflow restriction warnings, operating temperatures, and past failures.

To enter Diagnostic Status Report mode, press and hold the down arrows and, while holding press the FAN SPEED key for a period of five (5) seconds.

The meaning of figure on display pad is as below:
X.X---(0~4: time of protection)

L---is protection mode(1: anti-frost; 2: overheat; 3: high pressure; 4: anti-freezing)

Failure code	Content or detect
E2	Indoor temperature sensor failure
E3	Indoor coil temperature sensor failure
E5	Outdoor coil temperature sensor failure
E8	Overheating protection/defrosting
E9	High pressure protection

TROUBLESHOOTING

POSSIBLE CAUSES	SOLUTIONS
<p>UNIT DOES NOT START</p> <ul style="list-style-type: none"> Unit may be unplugged Fuse may have blown Circuit breaker may have tripped Unit may be off or in wall thermostat mode. Check section on dipswitch settings to verify dipswitches are set properly. Unit may be in a protection or diagnostic failure mode. See section on diagnostic codes. 	<ul style="list-style-type: none"> Check that plug is plugged securely in wall receptacle. Note: Plug has a test/reset button on it. Make sure that the plug has not tripped. Replace the fuse. Reset circuit breaker. Turn unit on (bottom right button on keypad).
<p>DISPLAY HAS STRANGE NUMBERS/CHARACTERS ON IT</p>	<ul style="list-style-type: none"> The unit may be in a diagnostic condition. Check diagnostic codes --- checking Control section to determine if unit has had a failure. The unit may be set for °C (instead of °F), see the SET UP OPERATION.
<p>UNIT MAKING NOISES</p>	<ul style="list-style-type: none"> Clicking, gurgling and whooshing noises are normal during operation of unit.
<p>UNIT NOT COOLING / HEATING ROOM</p> <ul style="list-style-type: none"> Unit air discharge section is blocked Temperature setting is not high or low enough Note: Setpoint limits may not allow the unit to heat or cool the room to the temperature desired. Check section on SET UP OPERATION settings. Unit air filters are dirty. Room is excessively hot or cold when unit is started Vent door left open Unit may be in a protection or diagnostic failure mode. Check section on Intelligent Self --- checking Control. Compressor is in time delay. There is a protective time delay (approx. 3 minutes) on starting the compressor after a power outage (or restarting after it has been turned off), to prevent tripping of the compressor overload. 	<ul style="list-style-type: none"> Make sure that curtains, blinds or furniture are not restricting or blocking unit airflow. Reset to a lower or higher temperature setting. Remove and clean filters. Allow sufficient amount of time for unit to heat or cool the room. Start heating or cooling early before outdoor temperature, cooking heat or gatherings of people make room uncomfortable. Close vent door. Check dipswitch settings for desired comfort. Wait approximately 3 minutes for compressor to start
<p>WATER DRIPPING INSIDE</p>	<ul style="list-style-type: none"> If a drain kit has not been installed, condensation run off during very hot and humid weather is normal. See Note 2. If a drain kit has been installed and is connected to a drain system, check gaskets and fittings around drain for leaks and plugs.
<p>WATER DRIPPING INSIDE</p> <ul style="list-style-type: none"> Wall sleeve is not installed level 	<ul style="list-style-type: none"> Wall sleeve must be installed level for proper drainage of condensation. Check that installation is level and make any necessary adjustments.
<p>ICE OR FROST FORMS ON INDOOR COIL</p> <ul style="list-style-type: none"> Low outdoor temperature Dirty filters 	<ul style="list-style-type: none"> When outdoor temperature is approximately 55°F (12.8 °C) or below, frost may form on the indoor coil when unit is in Cooling mode. Switch unit to FAN operation until ice or frost melts. Remove and clean filters.
<p>COMPRESSOR PROTECTION</p> <ul style="list-style-type: none"> Power may have cycled, so compressor is in a restart protection. 	<ul style="list-style-type: none"> Random Compressor restart-Whenever the unit is plugged in, or power has been restarted, a random compressor restart will occur. After a power outage, the compressor will restart after approximately 3 minutes. Compressor Protection-To prevent short cycling of the compressor, there is a startup delay of 3 minutes and a minimum compressor run time of 3 minutes.



LIMITED EXPRESS WARRANTY

Congratulations on purchasing your new HVAC equipment. It's been designed for long life and reliable service, and is backed by one of the strongest warranties in the industry. Your unit automatically qualifies for the warranty coverage listed below, providing you keep your proof of purchase (receipt) for the equipment and meet the warranty conditions.

LIMITED FIVE (5) YEAR EXPRESS WARRANTY

MARS warrants all parts of the PTAC/PTHP/PTT(C,E,H) to be free from defects in workmanship and materials for normal use and maintenance for five (5) year from the date of purchase by the original consumer for the original installation. This Express Limited Warranty applies only when the PTAC is installed as a complete system: indoor unit and only when the system is installed per MARS installation instructions and in accordance with all local, state and national codes for normal use.

LIMITED 2nd to 5th YEAR EXPRESS WARRANTY

The compressor only is warranted to be free from defects in workmanship and materials for normal use and maintenance for four additional years, for a total of five (5) years from the date of purchase by the original consumer for the original installation. This Express Limited Warranty applies only when the PTAC is installed as a complete system: indoor unit and only when the system is installed per MARS installation instructions and in accordance with all local, state and national codes for normal use.

LABOR

Labor charges, transportation charges, and replacement of refrigerant and filters are not covered except as noted in the terms of the one year Labor Warranty.

EXCEPTIONS

The Limited Express Warranty does not cover normal maintenance—MARS recommends that regular inspection/maintenance be performed at least once a season and proof of maintenance be kept. Additionally, labor charges, transportation charges for replacement parts, replacement of refrigerant or filters, any other service calls/repairs are not covered by this Limited Warranty. It also does not cover any portion or component of the system that is not supplied by MARS, regardless of the cause of failure of such portion or component.

CONDITIONS FOR WARRANTY COVERAGE

- Unit must be operated according to MARS operating instructions included with the unit and cannot have been subjected to accident, alteration, improper repair, neglect or misuse, or an act of God (such as a flood)
- Installation was done by a trained, licensed or otherwise qualified HVAC dealer/contractor
- Performance cannot be impaired by use of any product not authorized by MARS, or by any adjustments or adaptations to components
- Serial numbers and/or rating plate have not been altered or removed
- Damage has not been a result of inadequate wiring or voltage conditions, use during brown-out conditions, or circuit interruptions
- Air flow around any section of the unit has not been restricted
- Unit remains in the original installation
- Unit was not purchased over the internet

DURATION OF WARRANTY & REGISTRATION

The warranty begins on the date of purchase by the original consumer. The consumer must retain a receipted bill of sale as proof of warranty period. Without this proof, the express warranty begins on the date of shipment from the factory.

REMEDY PROVIDED BY THE LIMITED EXPRESS WARRANTY

The sole remedy under the Limited Warranty is replacement of the defective part. If replacement parts are required within the period of this warranty, MARS replacement parts shall be used; any warranty on the replacement part(s) shall not affect the applicable original unit warranty. Ready access to the unit for service is the owner's responsibility. Labor to diagnose and replace the defective part is not covered by this Limited Express Warranty. If for any reason the replacement part/product is no longer available during the warranty period, MARS shall have the right to allow a credit in the amount of the current suggested retail price of the part/product instead of providing repair or replacement.

LIMITATION OF LIABILITY

1. There are no other express or implied warranties. MARS makes no warranty of merchantability. We do not warrant that the unit is suitable for any particular purpose or can be used in buildings or rooms of any particular size or condition except as specifically provided in this document. There are no other warranties, express or implied, which extend beyond the description in this document.
2. All warranties implied by law are limited in duration to the five-year term of the parts warranty. Your exclusive remedy is limited to the replacement of defective parts. **We will not be liable for any consequential or incidental damages caused by any defect in this unit.**
3. This warranty gives you specific legal rights and you may also have other rights which vary from state to state. Some states do not allow limitation on how long an implied warranty lasts or do not allow the exclusion or limitation of incidental or consequential damages, so the above limitations or exclusions may not apply to you.
4. No warranties are made for units sold outside the continental United States and Canada. Your distributor or final seller may provide a warranty on units sold outside these areas.
5. MARS will not be liable for damages if our performance regarding warranty resolution is delayed by events beyond our control including accident, alteration, abuse, war, government restrictions, strikes, fire, flood, or other acts of God.

HOW TO OBTAIN WARRANTY SERVICE OR PARTS

If you have a warranty claim, notify your installer promptly. If the installer does not remedy your claim, write to MARS, 1900 Wellworth Ave., Jackson MI 49203. Enclose a report of inspection by your installer or service person. Include model number, serial number, and date of purchase.

Owner responsibilities are set forth in the instruction manual—read it carefully.

Please visit www.marsdelivers.com to register your new product



KEEP THIS INFORMATION AS A RECORD OF YOUR PURCHASE

Product Information

Installation

Model Number

Installer Name

Serial Number

Phone No./Contact Info

Date of Purchase

Date Installation Completed

Remember to retain your bill of sale as proof of warranty period.

Due to ongoing product improvements, specifications and dimensions are subject to change and correction without notice or incurring obligations. Determining the application and suitability for use of any product is the responsibility of the installer. Additionally, the installer is responsible for verifying dimensional data on the actual product prior to beginning any installation preparations.

Incentive and rebate programs have precise requirements as to product performance and certification. All products meet applicable regulations in effect on date of manufacture; however, certifications are not necessarily granted for the life of a product. Therefore, it is the responsibility of the applicant to determine whether a specific model qualifies for these incentive/rebate programs.

Comfort-Aire® **Century**®

1900 Wellworth Ave., Jackson, MI 49203 • Ph. 517-787-2100 • www.marsdelivers.com

