

This Owner's Manual is provided and hosted by [Appliance Factory Parts](http://Appliance Factory Parts).

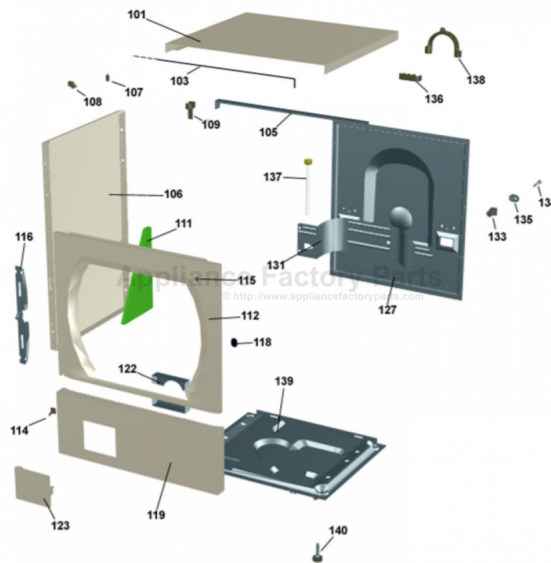

# ASKO W6441S Owner's Manual

[Shop genuine replacement parts for ASKO W6441S](#)



[Find Your ASKO Washer Parts - Select From 53 Models](#)

----- Manual continues below -----



ENGLISH

# WASHER USE AND CARE GUIDE

**IMPORTANT!**  
To get the best performance from your washer, read all operating instructions before using it for the first time.



FRANÇAIS

## CONTENTS

IMPORTANT SAFETY INSTRUCTIONS	2
CHILD SAFETY FEATURES	2
ASKO WASHER FEATURES	3
INSTALLATION INSTRUCTIONS	4
PREPARING THE LAUNDRY	6
THE DETERGENT DRAWER	8
DETERGENTS	8
FABRIC SOFTENERS	9
FABRIC DYEING	9
RECOMMENDED WASH TEMPERATURES	9
W6021 OPERATING INSTRUCTIONS	10
W6221 OPERATING INSTRUCTIONS	11
W6641 AND W6661 OPERATING INSTRUCTIONS	12
CARE AND MAINTENANCE INSTRUCTIONS	18
COMMON LAUNDRY PROBLEMS	19
TROUBLESHOOTING	20
ASKO PRODUCT WARRANTY	22
INDEX	23

ESPAÑOL

SAVE THESE INSTRUCTIONS FOR FUTURE REFERENCE

## IMPORTANT SAFETY INSTRUCTIONS

To reduce the risk of fire, electric shock, or injury to persons when using your appliance, follow basic precautions, including the following:

- ◆ Read all instructions before using the appliance.
- ◆ Do not run appliance while you are out of the home.
- ◆ Do not allow children to play on or in the appliance. Close supervision of children is necessary when the appliance is used near children.
- ◆ Before the appliance is removed from service or discarded, remove the door to the washing compartment.
- ◆ Do not reach into the appliance if the drum is moving.
- ◆ Do not install or store this appliance where it will be exposed to the weather.
- ◆ Do not tamper with controls.
- ◆ Do not repair or replace any part of the appliance or attempt any servicing unless specifically recommended in the user-repair instructions or in published user-repair instructions that you understand and have the skills to carry out.
- ◆ Do not add gasoline, dry-cleaning solvents, or other flammable or explosive substances to the wash water. These substances give off vapors that could ignite or explode.
- ◆ Under certain conditions, hydrogen gas may be produced in a hot water system that has not been used for 2 weeks or more. **HYDROGEN GAS IS EXPLOSIVE.** If the hot water system has not been

used for such a period, before using a washing machine or combination washer-dryer, turn on all water faucets and let the water flow from each for several minutes. This will release any accumulated hydrogen gas. As the gas is flammable, do not smoke or use an open flame during this time.

### **WARNING!**

**Do not wash or dry articles that have been previously cleaned in, washed in, soaked in, or spotted with gasoline, dry-cleaning solvents, cooking oils, or other flammable or explosive substances because they give off vapors that could ignite or explode.**

### **WARNING!**

**This appliance must be properly grounded. Improper connection of the equipment grounding conductor can result in a risk of electric shock. Check with a qualified electrician or serviceman if you are in doubt as to whether the appliance is properly grounded.**

**The plug must be plugged into an appliance outlet that is properly installed and grounded in accordance with all local codes and ordinances.**

**NOTE:** This manual does not cover every possible condition and situation that may occur. Use common sense and caution when installing, operating, and maintaining any appliance.

## CHILD SAFETY FEATURES

### **CHILD-SAFE DETERGENT DRAWER**

ASKO washers have a child-safety catch on the detergent drawer that can be engaged to prevent a child from opening the drawer and possibly coming into contact with the detergent or fabric softener. Refer to page 8 for instructions on how to engage the child-safe catch.

### **CHILD-SAFE TEMPERATURE KNOB**

Models W6021 and W6221 have a child-safety catch that can be engaged to prevent children from tampering with the temperature knob. The catch is located below the temperature knob behind the edge of the control panel. To engage it, insert a flathead screwdriver in the slot on the catch. Press upwards as you turn the catch clockwise. When you release the catch it should protrude slightly below the control panel.

Once the catch is engaged, you must hold it up as you turn the temperature knob to the desired setting.

### **CHILD-SAFE START**

You can program Models W6641 and W6661 not to start unless the Start button is held down for three seconds. This is to prevent children from inadvertently

starting the machine. Refer to page 17 for instructions on how to program this safety feature.

### **MORE CHILD-SAFETY TIPS**

- ◆ Laundry detergents are corrosive, so always keep them out of reach of children.
- ◆ Should a child swallow detergent, give plenty to drink immediately, i.e., one or two glasses of milk or water. Do not try to induce vomiting. Seek medical advice immediately: **1-800-POISON1**
- ◆ Always close the door and start the appliance as soon as you put in the detergent.
- ◆ Always turn the power off to the machine when it is not in use.
- ◆ Always keep small children away from the machine when it is open. There may be some detergent residue left inside the machine.
- ◆ If laundry detergent gets in someone's eyes, rinse them with plenty of water for at least 15 minutes.
- ◆ Do not allow children to use or play on or in the appliance.

## ASKO WASHER FEATURES

Your new energy-efficient ASKO washer is designed to give you maximum cleaning performance using less water, energy and detergent. To make the most of the washer's functions and features, we recommend that you read this manual carefully before using your machine for the first time. For operating instructions, refer to pages 10 through 17.

Below is an illustration of the external parts and features of your ASKO washer.

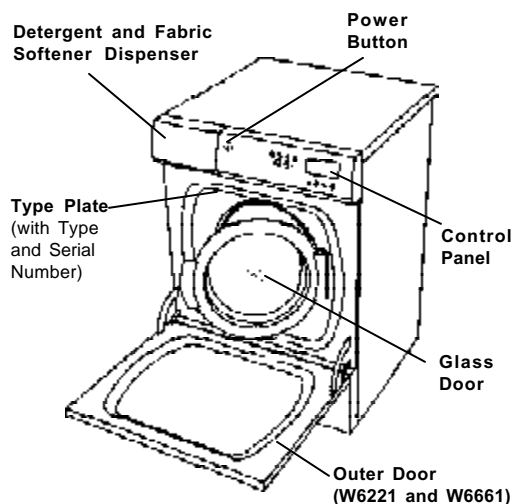

### THE GLASS DOOR

To open the glass door, the power to the machine must be on and you must press the Door Open button (🔌). There will be a few seconds delay before the door opens.

Refer to "The door won't open" section in the Troubleshooting chart on page 21 for instructions on how to open the glass door in case of a mechanical or power failure.

#### Models W6021 and W6221

On these models, the unit must be at the end of a program to open the glass door. If you need to stop or interrupt a program after you start the machine, press the Door Open button (🔌). Any water in the machine will be pumped out and the door should open on its own. To restart the washer, close the door, add detergent (if needed), and turn the controls to the desired settings.

#### Models W6641 and W6661

On these models, if you need to open the door during a wash or rinse cycle, press and hold Door Open for three seconds. The machine will stop and automatically drain enough water so the door can be opened safely. The program will resume when you close the door.

### SENSOR LEVEL CONTROL (SLC)

ASKO washers do not need high, medium, or low water level settings to compensate for different sized loads. ASKO units have a consumption sensor—Sensor Level Control—that ensures the correct amount of water is pumped into the machine for any size load. It even compensates for fabric saturation, letting in more water if needed. This eliminates worry about selecting the right water level setting for each laundry load.

### TEMPERATURE CONTROL

Because wash water temperature is a major factor in getting laundry clean, ASKO washers have built-in heating elements and a sensor that keeps the temperature to within  $\pm 1^\circ$  F of the selected program temperature.

ASKO washers are programmed not to advance in a cycle until the selected water temperature is reached, so the length of the cycles may vary, depending upon the household cold water temperature, the amount of laundry in the washer, and the wash temperature setting.

### ENZYME STEP

To successfully remove all dirt and stains from fabric, the enzymes in your detergent need to work at a temperature between  $105^\circ$  and  $140^\circ$  F for a longer time period. For this reason, the main wash cycle in a Normal wash program on ASKO washers is 43 minutes (plus the amount of time it takes to heat the water to the selected temperature). This longer wash cycle gives the enzymes in the detergent ample time to remove stains, eliminating the need for stain sprays and spot removers.

The prewash option should be used only for heavily soiled loads. Starting the machine at the main wash stage will save about 25 minutes.

### MORE RINSE CYCLES

Most washers have only two or three rinse cycles; some have an option to add a fourth. ASKO washers have five rinses and a Super Rinse option that adds two more. ASKO washers get the soil and detergent out of your laundry that most other washers leave in. That's why your whites will remain white and your colored fabrics will remain bright.

### SUPER RINSE OPTION

This option is designed for people with sensitive skin or who are allergic to detergents. It can also be used for large, heavily soiled loads.

### SPIN OPTIONS

ASKO washers have faster spin speeds than most other washers, which decreases the time it takes to dry your laundry by up to half. The spin speeds range from 400 rpm to 1600 rpm, depending on the model. You can also turn the spin cycle off.

# INSTALLATION INSTRUCTIONS

Read these instructions carefully and completely before you install the machine. The installation should be carried out by a qualified person who is familiar with all local codes and ordinances for electrical and plumbing connections.

## IMPORTANT NOTE:

**Cosmetic damage must be reported to your dealer within five days from the date of purchase. After unpacking the washer, thoroughly check the unit for cosmetic damage.**

## SPECIFICATIONS

Height	33-1/2"-34-1/2" (850-876 mm)	Drum and Barrel	Stainless steel
Width	23-7/16" (595 mm)	Outer casing	Stove-enamelled hot-dipped galvanized steel or stainless steel
Depth	W6641/W6661: 23-7/16" (595 mm) W6021/W6221: 24-7/16" (620 mm)	Mounting	Four adjustable rubber-covered feet
Weight	167 lbs. (73 kg)	Inlet supply hose	5 ft. (1.5 m) PEX tubing with brass ferrules
Rated load	See data plate	Supply pressure	15-142 PSI
Supply voltage	Single-phase 230 V, 60 Hz	Outlet hose	5.5 ft. (1.7 m) polypropylene hose, 3/4" ID
Heating element	2000 W		
Fuse	15 A (2 internal fuses)		

## REMOVING THE SHIPPING SUPPORTS

The machine is transported with three shipping supports, as illustrated below. These supports hold the tub in place during shipment. When you unpack the machine, you must remove these supports.

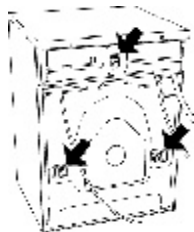

You must remove the shipping supports before you install the washer.

To remove the shipping supports, follow the instructions below:

1. Unscrew the 5/8" (12 mm) bolts holding the supports in place and remove the bolts.



2. Push the rubber spacer up then pull it out of the slot.



3. Rotate the spacer so that the extruded end points toward the machine.



4. Insert it into the slot and push down to lock it into position.



## LEVELING THE MACHINE

It is important that the machine is level so it won't vibrate excessively during the spinning cycles. Each foot on the washer is adjustable, so you can level the washer on any surface. Once it is level, securely tighten the lock nuts on the feet to prevent excessive vibration during the spin cycles.

Be sure to tighten the lock nuts securely when you level the machine.

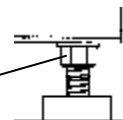

## WATER SUPPLY CONNECTION

Because ASKO washers have their own heating element, you only need to have a cold water inlet. The connection should be made by someone who is sufficiently skilled. Use the hose supplied with the washer.

Water pressure must be in the range of 15-146 PSI.

A tap should be fitted on the water supply pipe.

If a new supply pipe has been installed for the washer, it should be flushed thoroughly to remove any foreign particles that might clog the strainer in the water inlet.

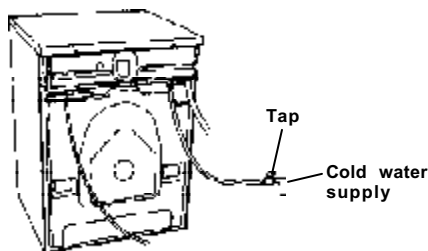

**NOTE:** If unit is installed on a second story, follow local building codes. We recommend a drip pan be installed.

## DRAIN OUTLET CONNECTION

The machine is supplied with the outlet hose already attached. The hose should be extended over a suitable sink edge or drain pipe at a height of 24" to 36" (610 mm to 914 mm) above the bottom of the unit. (The lower height is preferable.) Make sure that the hose is not kinked.

**NOTE:** If the hose is extended, the internal diameter of the coupling must not be less than 1/2".

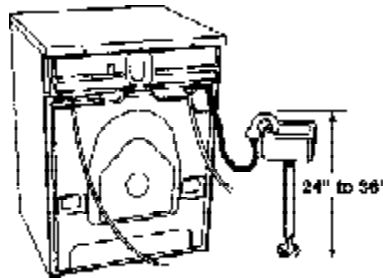

**WARNING!** Do not extend the drain hose higher than 36" (914 mm) from the bottom of the unit.

## ELECTRICAL CONNECTIONS

The machine is delivered ready-fitted with a plug and is intended for connection to an ASKO Dryer, which is equipped with a matching receptacle. The plug supplied with the washer can only be used with an ASKO Dryer. If the washer is used separately or with another dryer, it must be on a separate 220 V single-phase circuit.

If the machine is to be used in a wet area, the supply must be protected by a residual current device.

As supplied: 230 V, 60 Hz  
2000 W heating element  
15 A fuse required

**WARNING!** Connection to a permanently wired supply point must be made only by a qualified electrician.

### GROUNDING INSTRUCTIONS

This appliance must be grounded. In the event of malfunction or breakdown, grounding will reduce the risk of electric shock by providing a path of least resistance for electric current. This appliance is equipped with a cord having an equipment-grounding conductor and a grounding plug. The plug must be plugged into an appropriate outlet that is properly installed and grounded in accordance with all local codes and ordinances.

**WARNING!** Improper connection of the equipment-grounding conductor can result in a risk of electric shock. Check with a qualified electrician or serviceman if you are in doubt as to whether the appliance is properly grounded.

Do not modify the plug provided with the appliance. If it will not fit the outlet, have a proper outlet installed by a qualified electrician.

## FREESTANDING INSTALLATION

The washer can be placed next to the dryer. It is essential that the machine is leveled and the locknuts tight to prevent excessive vibration during the spin cycles. Also be sure to leave a minimum of 1/2" (12 mm) of space between the washer and the dryer.

The height adjustment for the washer is 33-1/2" to 34-1/2" (850 mm to 876 mm). Do not raise it higher than 34-1/2".

## STACKED INSTALLATION

ASKO washers should never be stacked on a counter or a dryer. You can, however, stack an ASKO dryer on an ASKO washer. Refer to your *Dryer Use and Care Guide* for instructions on how to do this.

## BUILT-IN INSTALLATION

ASKO washers can be installed beneath a cabinet or worktop with a height of 34-1/2" (876 mm). There must be a gap of about 1/2" (12 mm) all around the machine, including between the rear edge of the machine top panel and the back wall. The opening width must be at least 24-1/2" (622 mm).

Space must also be available for the inlet and drain hoses. See the diagram below for measurements and positions.

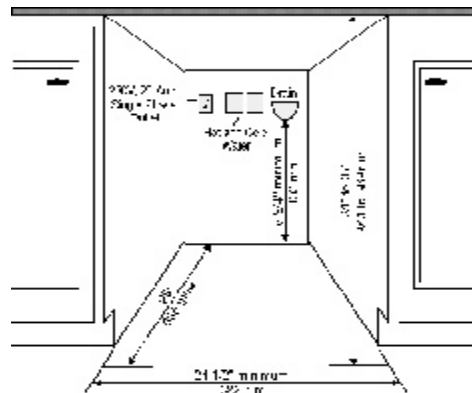

If the drain outlet is higher than 24", the connections will need to be recessed.

## PREPARING THE LAUNDRY

We believe ASKO washers clean better than any other washer available on the market. With proper attention to how you prepare your laundry items for washing and drying, your wardrobe and linens will look like new for years.

### SORTING THE LAUNDRY

Properly sorting your laundry is a very important factor in ensuring that your clothing and linens look new for a long time. Another important factor is properly following the care label instructions (see next page).

Below are some basic rules for sorting your laundry:

#### Sort by

##### 1. Fabric color

Whites; pastels and medium colors; bright colors; dark colors

##### 2. Amount of soil

Heavily soiled items should be washed separately from lightly soiled items.

##### 3. Fabric Type



Delicates should be washed separately. You should also consider separating fabrics that tend to shed lint (e.g., cotton, chenille, and terrycloth) from fabrics that attract lint (e.g., permanent press, corduroy, velveteen, flannel and synthetics).

#### IMPORTANT NOTE:

If the care label says "Wash Separately," the fabric is likely to lose color (excess dye) for the first few washings. To minimize the possibility of the color transferring to white or lighter colored items, wash new colored garments with items of similar color or separately. Bright reds and oranges on cottons are the dyes most likely to transfer colors to the wash load. Fluorescent colors should always be washed separately.

### RECOMMENDED LOAD SIZES

To reduce wrinkling, you should determine the load size based on the type(s) of fabrics being washed. The chart below gives recommended load sizes for different fabrics.

Load Size	Fabrics
Full 	Cotton, linen
Half 	Perm press, synthetics, acrylics
Third 	Special finish cottons, machine washable wool, silk, acetates

### Cotton and Linen Fabrics

These items should be washed in full loads because the tumble action of the tub along with the gentle rubbing and lifting and falling movement of the clothes gives the best cleaning result.

### Permanent Press Fabrics

These items need more room to move freely during washing for the most wrinkle-free results. Therefore, fill the machine only half full for permanent press loads. These items should have only a brief spin cycle and they should be removed promptly from the washer and put directly into the dryer or hung to dry.

### Delicate Fabrics

More delicate fabrics, such as machine washable wool and silk, should only be washed in one-third size loads for the best results.

### ADVICE FOR PERSONS WITH SENSITIVE SKIN

ASKO washers are ideal for people allergic to detergent. Our Heavy, Normal and Light wash programs have five rinse cycles and a Super Rinse option that adds two more rinses. This ensures that all the detergent residue is rinsed out of your laundry.

As an extra precaution, you should use mild detergents and be careful not to use too much.

### GENERAL LAUNDRY ADVICE

- ◆ Always follow the care label instructions (see page 7).
- ◆ Remove any sharp ornaments, pins or buckles to prevent snags.
- ◆ Empty pockets and turn them inside out.
- ◆ Close zippers and hooks to prevent snagging.
- ◆ Tie sashes and strings to prevent tangling.
- ◆ Mend any small rips to prevent them from enlarging.
- ◆ Turn colored cotton garments, velvet and finer knitwear inside out before washing.
- ◆ Turn delicate items, sweaters and T-shirts inside out to prevent pilling and to protect the prints.
- ◆ Prewash severely soiled items.
- ◆ Wash colored fabrics separately the first time.
- ◆ Thoroughly rinse down items, such as comforters (Super rinse).
- ◆ Use fabric softener to eliminate static electricity in synthetic garments and to soften cotton.

**CARE LABEL INSTRUCTIONS**





































Most clothes and other washable items have permanent care labels. *Read these labels carefully!* Care label instructions and warnings should be followed for the best cleaning results.

The table below defines the symbols used on fabric care labels. (NOTE: Some manufacturers may use slightly different symbols.)

As an example, the symbols in the label illustrated below mean: wash in warm water on permanent press setting. Do no bleach. Dry on permanent press setting. Iron on low temperature setting.



**CARE LABEL SYMBOLS**

<p><b>WASH CYCLE</b></p> <ul style="list-style-type: none"> <li> Normal wash cycle</li> <li> Permanent Press or Wrinkle Resistant setting</li> <li> Gentle/Delicate setting</li> <li> Hand wash only</li> <li> Do not wash</li> <li> Do not wring, Hang dry, drip dry, or dry flat</li> </ul>	<p><b>TUMBLE DRY CYCLE</b></p> <ul style="list-style-type: none"> <li> Machine dry</li> <li> Normal setting</li> <li> Permanent Press or Wrinkle resistant setting</li> <li> Gentle or Delicate setting</li> <li> Do not tumble dry</li> </ul>
<p><b>WASH WATER TEMPERATURE</b></p> <ul style="list-style-type: none"> <li> Maximum water temp 200 F/95 C</li> <li> Maximum water temp 160 F/70 C</li> <li> Maximum water temp 140 F/60 C</li> <li> Maximum water temp 120 F/50 C</li> <li> Maximum water temp 105 F/40 C</li> <li> Maximum water temp 85 F/30 C</li> </ul>	<p><b>TUMBLE DRY HEAT SETTING</b></p> <ul style="list-style-type: none"> <li> Any heat</li> <li> High heat</li> <li> Medium heat</li> <li> Low heat</li> <li> No heat/Air fluff</li> </ul>
<p><b>BLEACH INSTRUCTIONS</b></p> <ul style="list-style-type: none"> <li> Any bleach when needed</li> <li> Only non-chlorine bleach</li> <li> Do not bleach</li> </ul>	<p><b>SPECIAL DRYING INSTRUCTIONS</b></p> <ul style="list-style-type: none"> <li> Line dry or hang to dry</li> <li> Drip dry (do not spin or wring)</li> <li> Dry flat</li> <li> Dry in shade</li> </ul>
<p><b>DRY CLEAN SYMBOL</b></p> <ul style="list-style-type: none"> <li> Dry clean only</li> </ul>	<p><b>IRONING INSTRUCTIONS</b></p> <ul style="list-style-type: none"> <li> Ironing is necessary</li> <li> High temperature setting</li> <li> Medium temperature setting</li> <li> Low temperature setting</li> <li> Do not iron or press with heat</li> <li> Iron without steam</li> </ul>

## THE DETERGENT DRAWER

The detergent drawer on ASKO washers automatically dispenses the detergent and fabric softener at the appropriate times. Simply pour the measured amounts of detergent and softener into the proper compartments (as illustrated) and close the drawer.

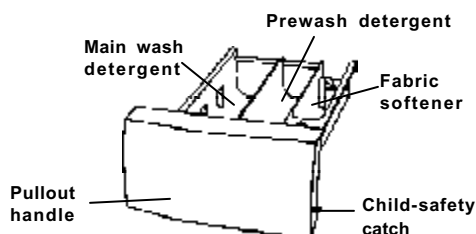

**NOTE:** To avoid oversudsing, do not put detergent in the prewash compartment unless you are using one of the Heavy wash programs which has a prewash cycle.

**We recommend that you don't use bleach in your ASKO washer.** The tumbling wash action, temperature control options, extended wash times and proper amount of detergent are sufficient to remove most stains.

### Child-Safe Catch

All ASKO 6000-series washers have a child-safe catch on the detergent drawer that can be engaged to prevent a child from opening the drawer and possibly coming into contact with the detergent or fabric softener.

The safety catch is the red plastic piece on the back right side of the pull-out handle. To engage the catch, open detergent drawer a little then pull the catch forward and release it. Once the catch is engaged, you must push it to the left each time you open the detergent drawer.

To disengage the catch, push it to the left then back.

## DETERGENTS

Laundry detergents are available in low-, normal- and high-sudsing formulas. A detergent's ability to clean is not relative to the amount of suds it produces. Excess suds in a front-loading washer actually interfere with the cleaning because they cushion the tumbling action. Also, high-sudsing detergents are more difficult to completely rinse out.

**The use of anything other than a low-sudsing detergent can cause severe oversudsing,** which could cause suds to backup through the detergent compartment and run down the front of the washer onto the floor. If oversudsing occurs, run the wash through one or more rinse programs until all items are thoroughly rinsed. Remove the laundry then run the washer through a Normal wash program to get rid of any remaining detergent.

### LIQUID DETERGENTS

We don't recommend liquid detergents because they tend to produce more suds than powder detergents when used in water temperatures of 150° F or higher. If you should try a liquid detergent, start with a very small amount, such as **1 to 2 tablespoons**. Also, liquid detergent can be used for all programs without prewash, so add it into the main wash compartment.

Should you prefer to use a liquid detergent, we have provided a partition piece with the detergent drawer specifically for use with liquid detergents. Insert the partition in the slot at the back of the main wash compartment before you pour in the liquid detergent.

**NOTE:** The partition piece is packaged on the bottom of the detergent drawer.

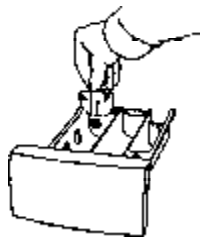

### RECOMMENDED POWDER DETERGENTS

ASKO washers use 50% to 75% less detergent than most other washers. This is because of their low water consumption and the fact that all the wash water is repeatedly circulated through the laundry, ensuring that all the detergent is fully utilized. We recommend that you use powder detergents made specifically for front-loading washers. These are sometimes called HE (High-Efficiency) detergents. Listed below are some low-sudsing powder detergents that have been successfully tested in ASKO washers:

- ◆ Fab
- ◆ Amway SA8
- ◆ Fresh Start
- ◆ All
- ◆ Tide HE
- ◆ Wisk HE

We recommend that you do not use any powder detergent that doesn't wash completely out of the detergent drawer.

### AMOUNT OF DETERGENT TO USE

The amount of detergent needed varies among the different brands, but for most detergents, **you need only one or two tablespoons**. Using too much detergent can result in detergent residue being left in your clothes, which can cause them to appear gray or dingy. You should start with a small amount of detergent and increase it only if the cleaning results are unsatisfactory.

Additionally, you should never put detergent in the prewash compartment unless you are using a wash program that has a prewash cycle. This could cause excess foaming, which could damage the machine.

The amount of detergent needed can also depend on the hardness of the water in your area. See the "Detergent Amounts Based on Water Hardness" section on the next page for more details.

## Detergent Amounts Based on Water Hardness

The amount of detergent needed can vary due to differences in water hardness. To determine the water hardness in your area, contact your local water utility or area water softening company. The harder the water, the more detergent you may need. Refer to the chart below for the recommended detergent amounts based on water hardness. Remember, you should adjust the amount of detergent you use by small amounts until you find the correct amount.

Note that 12 grains and higher is extremely hard water and detergent alone may not be enough. You may need

to use a water softener to maximize the performance of your washer. Also, in areas with extremely hard water (9+) you may need to wash at lower temperatures to prevent hard water deposits from forming in the tank and wash system.

Different brands of detergent have different amounts of phosphorous for softening water. If you have hard water and use a detergent with less than 8.7% phosphorous content, you may need to use more detergent or use a detergent with a higher phosphorous content.

*Recommended Detergent Amounts  
Based on Water Hardness*

<i>Water Hardness</i>	<i>Detergent Amounts</i>	
	<i>Prewash</i>	<i>Main Wash</i>
<b>Soft</b> (0-3 grains per gal.)	1 teaspoon	1 to 1-1/2 tablespoons
<b>Medium</b> (4-8 grains per gal.)	1 teaspoon	1 to 2 tablespoons
<b>Hard</b> (9+ grains per gal.)	1 teaspoon	2 to 3 tablespoons

## FABRIC SOFTENERS

Fabric softeners are available in several concentrations. We recommend that you use only two tablespoons of

fabric softener. If more softening is desired, try adding slightly more the next time.

## FABRIC DYEING

To dye fabrics in your washing machine, pour the dye directly into the drum, not in the detergent compartment. Select Normal wash with the Super Rinse option and use the temperature recommended on the dye package. If you're dyeing polyester, select a spin speed

of 800 rpm.

After you have removed the dyed items, be sure to clean the drum before you wash a load of laundry. Do this by running the empty machine through a Normal wash program using the normal amount of detergent.

## RECOMMENDED WASH TEMPERATURES

Different fabrics require different wash temperatures. The table below gives recommended wash temperatures

for different fabrics as well as recommended programs, load sizes, and spin options.

<i>Fabric Type</i>	<i>Wash Temp.</i>	<i>Wash Program</i>	<i>Load Size<sup>(1)</sup></i>	<i>Spin Options<sup>(2)</sup></i>
White cotton w/out elastic and/or decorative trim	140–205° F	Normal	Full	Long spin, high rpm
White cotton w/elastic and/or decorative trim	120–140° F	Normal	Full	Long spin, high rpm
Colored cotton	120–140° F	Normal	Full	Long spin, high rpm
Linen (white and colorfast)	120–140° F	Normal	Half	Short spin, low rpm
Cotton/polyester blends	105–120° F	Normal/Permanent press	Half	Short spin, low rpm
Polyester/acrylic blends	105–120° F	Normal/Permanent press	Half	Short spin, low rpm
Rayon and acetate	105° F	Delicate/Wool	Half	Short spin, low rpm
Washable silk and nylon	85° F (cold)	Delicate/Wool	Third	Short spin, low rpm
Washable wool and wool blends	85–105° F (cold)	Delicate/Wool	Third	Short spin, low rpm
Handwash wool & silk <sup>(3)</sup>	85° F (cold)	Delicate/Wool	Third	Short spin, low rpm

### NOTES:

- (1) The load size should be determined by the type of fabric being washed. (See page 6.)
- (2) Spin speed options are not available on all models.
- (3) Some hand-washable wool and silk items should not go through a spin cycle. These items should be removed from the washer then pressed out in a terry towel to remove excess water before being hung up or laid flat to dry.

# W6021 OPERATING INSTRUCTIONS

## THE CONTROL PANEL

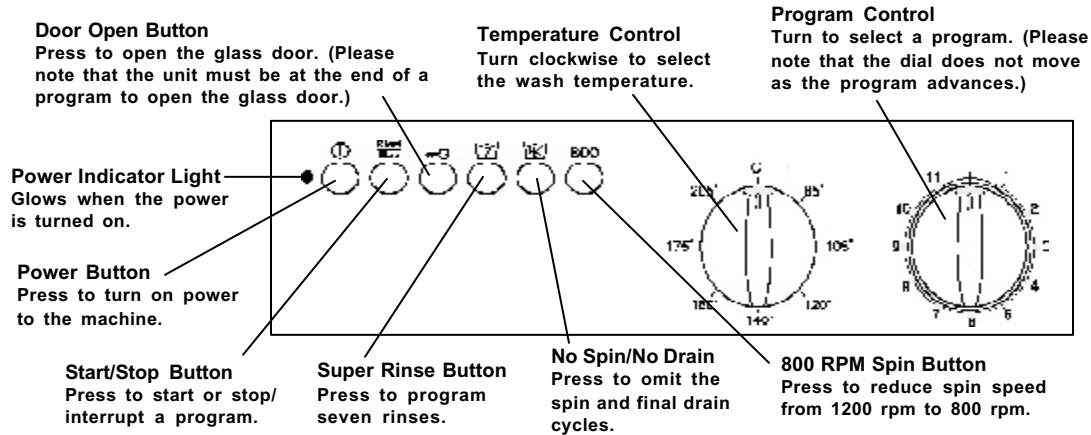

### POWER BUTTON

The Power button turns the power to the machine on and off. When the power is on, the power indicator light glows red. The power must be on before you can open the door, set the programs or start the machine.

### START/STOP BUTTON

Once you've selected the program and options, press this button to start the washer. To stop the washer during a program, press and hold this button down for a few seconds. If you press this button to stop a program, you will have to reselect the program to restart the unit.

### DOOR OPEN BUTTON

The power must be on and you must press this button

to open the door. There will be a few seconds delay before the door opens. Please note that the unit must be at the end of a program and the water drained before the door will open.

### INTERRUPTING OR CHANGING A PROGRAM

If you wish to interrupt a program to add an item to the wash, press and hold the Start/Stop button until the unit stops. Turn the Program Control knob to 11 (Drain) to drain the water. Press the Door Open button. The door will open when the water has drained. Insert the item you wish to wash and close the door. Add detergent (if needed), turn the control knobs to the desired settings, and press Start/Stop to restart the machine.

## W6021 PROGRAMS AND OPTIONS

Your ASKO washer has several programs and options specifically designed to give you the cleanest laundry

possible. The tables below define each program and option.

Dial #	Program	Pre-wash	Main Wash	Wash Action	Temp. (°F)	# Rinses	Int. Spin	Final Spin	Spin Speed	Load Size
1	Stain	yes	Long	Normal	140	5	2	Long	1200	Full
2	Heavy wash	no	Long	Normal	140	5	2	Long	1200	Full
3	Normal wash	no	Short	Normal	105	5	2	Long	1200	Full
4	Synthetic wash	no	Short	Normal	105	3	no	short	800	Half
5	Quick wash	no	Short	Normal	105	3	no	Long	1200	Full
6	Super quick wash	no	Short	Normal	105	2	no	Short	800	Half
7	Wool wash	no	Short	Gentle	85	3	no	Short	800	Third
8	Hand wash/Delicate	no	Short	Gentle	85	3	no	Short	800	Third
9	Rinse	n/a	n/a	n/a	n/a	1	n/a	Long	1200	Full
10	Spin	n/a	n/a	n/a	n/a	n/a	n/a	Long	1200	Full
11	Drain	n/a	n/a	n/a	n/a	n/a	n/a	n/a	n/a	Full

**NOTE:** Program times will increase when you select higher wash temperatures. (See "Temperature Control" on page 3.)

**CAUTION!** Some fabrics may not be able to withstand extremely hot temperatures. Please refer to the Recommended Wash Temperatures chart on page 9.

Option

Definition



**Super Rinse** – Provides two additional rinses. Recommended for persons with sensitive skin or allergies.



**No Spin/No Drain** – Omits spin cycles in all programs and final drain. If you select this option, you will have to run the Drain program (11) before you can open the door.

**800**

Reduces the spin speed from 1200 rpm to 800 rpm. (Does not apply to Rinse and Spin programs.)

# W6221 OPERATING INSTRUCTIONS

ENGLISH

## THE CONTROL PANEL

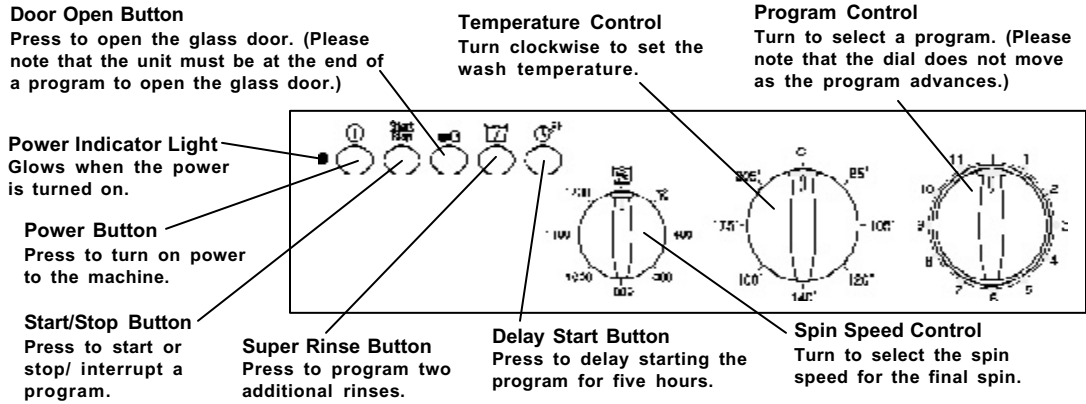

### POWER BUTTON

The Power button turns the power to the machine on and off. When the power is on, the power indicator light glows red. The power must be on before you can open the door, set the programs or start the machine.

### START/STOP BUTTON

Once you've selected the program and options, press this button to start the washer. To stop the washer during a program, press and hold this button down for a few seconds. If you press this button to stop a program, you will have to reselect the program to restart the unit.

### DOOR OPEN BUTTON

The power must be on and you must press this button to open the door. There will be a few seconds delay before the door opens. Please note that the unit must be at the end of a program and the water drained before the door will open.

### INTERRUPTING OR CHANGING A PROGRAM

If you wish to interrupt a program to add an item to the wash, press and hold the Start/Stop button until the unit stops. Turn the Program Control knob to 11 (Drain) to drain the water. Press the Door Open button. The door will open when the water has drained. Insert the item you wish to wash and close the door. Add detergent (if needed), turn the control knobs to the desired settings, and press Start/Stop to restart the machine.

### SPIN SPEED CONTROL

In addition to the 400 rpm to 1200 rpm spin speed options, the Spin Speed Control has a No Spin/No Drain option (No Spin icon) and a No Spin (No Spin icon) option. These are for delicate fabrics that should not be spun dry. (NOTE: If you select No Spin/No Drain, you will have to run the Drain program (11) before you can open the door.)

## W6221 PROGRAMS AND OPTIONS

Your ASKO washer has several programs and options specifically designed to give you the cleanest laundry

possible. The tables below define each program and option.

Dial #	Program	Pre-wash	Main Wash	Wash Action	Temp. (°F)	# Rinses	Int. Spin	Final Spin	Spin Speed	Load Size
1	Stain	yes	Long	Normal	140	5	2	Long	1200	Full
2	Heavy wash	no	Long	Normal	140	5	2	Long	1200	Full
3	Normal wash	no	Short	Normal	105	5	2	Long	1200	Full
4	Synthetic wash	no	Short	Normal	105	3	no	short	800	Half
5	Quick wash	no	Short	Normal	105	3	no	Long	1200	Full
6	Super quick wash	no	Short	Normal	105	2	no	Short	800	Half
7	Wool wash	no	Short	Gentle	85	3	no	Short	800	Third
8	Hand wash	no	Short	Gentle	85	3	no	Short	800	Third
9	Rinse	n/a	n/a	n/a	n/a	1	n/a	Long	1200	Full
10	Spin	n/a	n/a	n/a	n/a	n/a	n/a	Long	1200	Full
11	Drain	n/a	n/a	n/a	n/a	n/a	n/a	n/a	n/a	Full

**NOTE:** Program times will increase when you select higher wash temperatures. (See "Temperature Control" on page 3.)

**CAUTION!** Some fabrics may not be able to withstand extremely hot temperatures. Please refer to the Recommended Wash Temperatures chart on page 9.

Option Definition

- Super Rinse** – Provides two additional rinses. Recommended for persons with sensitive skin or allergies.
- Delay Start** – Automatically delays starting the program for five hours.

# W6641 AND W6661 OPERATING INSTRUCTIONS

## THE CONTROL PANEL

Models W6661 and W6641 have ASKO's state-of-the-art EasyControl™ panel, as illustrated below. To select a wash program, simply press one of the preset

program buttons then press Start. Refer to "Preset Programs" below for a definition of these programs.

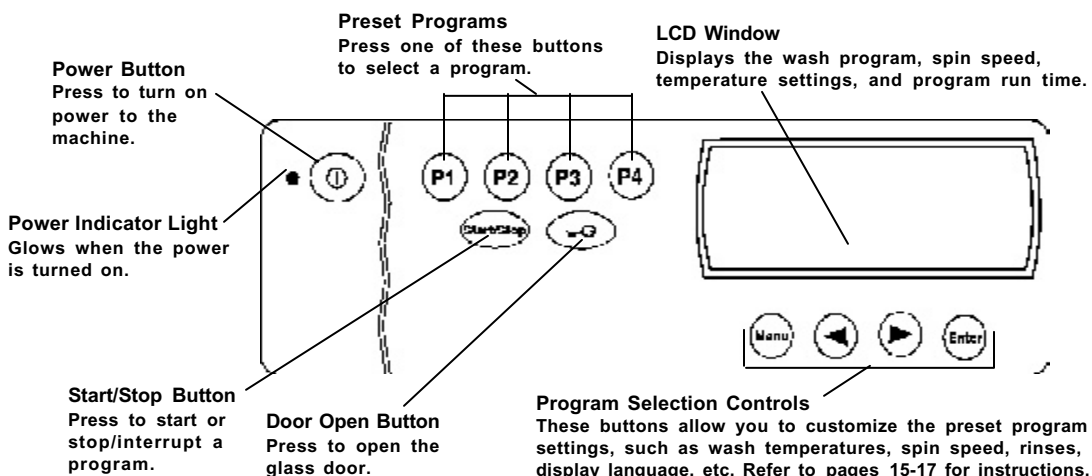

### POWER BUTTON

The Power button turns the power to the machine on and off. When the power is on, the power indicator light glows red. The power must be on before you can open the glass door, set the programs or start the machine.

### DOOR OPEN BUTTON

The power must be on and you must press this button to open the glass door. There will be a few seconds delay before the door opens.

If you need to open the door during a program, press and hold Door Open for a few seconds. The machine will stop and automatically drain enough water so the door can be opened safely. The program will resume when you close the door. For instructions on how to open the door manually in case of power failure, see page 21.

### START/STOP BUTTON

This button starts or stops a program. To stop a program, press and hold this button for a few seconds. If you stop a program using the Start/Stop button, you will have to reselect a program and press Start/Stop to restart the machine.

## UNDERSTANDING THE LCD WINDOW

The LCD window is easy to read and understand. It displays the wash program selection along with the wash temperature, spin speed, and program run time.

The illustration below explains each item on the LCD window.

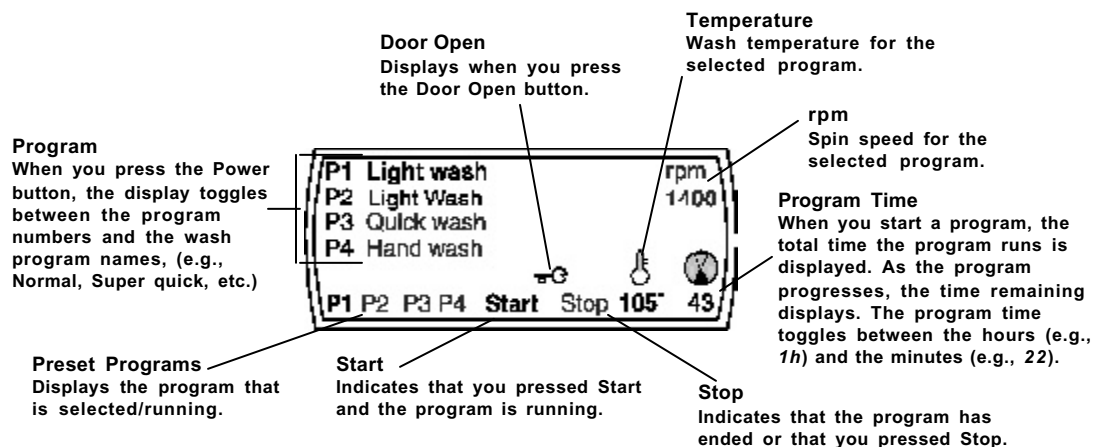

## THE PRESET PROGRAMS P1 P2 P3 P4

ASKO washers are delivered preset with four commonly used programs. The table below lists the preset programs and the settings for each. To select a program, simply press one of the program buttons and press Start. For additional programming options, refer

to "Customizing the Preset Program Buttons" below. Remember, you can temporarily adjust the temperature setting and spin speed for a preset program. (See "Making Temporary Program Changes" below.)

PRESET PROGRAMS

Preset Program	Wash Cycle	Types of Laundry	Wash Temp <sup>(1)</sup>	Spin Speed <sup>(1)(2)(3)</sup>	# of Rinses	# Spins
P1	Light wash	Normally soiled loads	140° F	1600 rpm	5	3
P2	Light wash	Normally soiled perm press	105° F	1600 rpm	5	3
P3	Quick wash	Lightly soiled fabrics	105° F	1600 rpm	3	1
P4	Hand wash	Washable silks, nylon, etc.	85° F	800 rpm	3	1

- NOTES:** (1) You can temporarily adjust the temperature and spin speed settings. (See "Making Temporary Program Changes" below.)  
 (2) The spin speeds in the preset programs are the maximum speed settings for these specific wash programs.  
 (3) Model W6641 has a maximum spin speed of 1400 rpm.

**WARNING!** Some fabrics may not be able to withstand extremely hot temperatures. Please refer to the "Recommended Wash Temperatures" section on page 6.

### MAKING TEMPORARY PROGRAM CHANGES

You can make temporary changes to the wash temperature and/or spin speed on the preset programs. Simply press the button for the preset program you want to use then follow the instructions at right. The settings will revert to normal at the end of the program.

**Temperature** – Press  until the desired temperature displays in the LCD window. (The options are 85°, 105°, 120°, 140°, 160°, 175°, and 205°.) If you also want to change the spin speed, read the following paragraph; otherwise, press Start.

**Spin Speed** – Press  until the desired spin speed displays in the LCD window then press Start. (The spin speeds advance in 200 rpm increments.)

### CUSTOMIZING THE PRESET PROGRAM BUTTONS

ASKO's EasyControl™ panel makes it simple to customize the preset programs to perfectly fit your laundry needs. You needn't worry about making an error because you can easily restore the original program settings.

In addition to the preset programs listed above, you can customize the preset buttons to use any of the programs listed in the table below.

This table also lists the pre-programmed settings for each program. For example, if you select Perma Press on the program menu, it is automatically programmed to wash at 105° F using a normal wash action, rinse three times then do a short spin, then rinse two more times, do a long spin and drain. You can modify some of these settings (see "Wash Program Options" on page 14).

AVAILABLE PROGRAMS

Program	Pre-wash	Main Wash	Wash Action	Temp. (° F)	# Rinses	Int. Spin	Final Spin	Spin Speed (1)	Load Size
Heavy wash	yes	Long	Normal	140	5	2	Long	1600	Full
Normal wash	no	Long	Normal	140	5	2	Long	1600	Full
Light wash	no	Short	Normal	140	5	2	Long	1600	Full
Synthetic wash	no	Short	Normal	105	3	no	Short	800	Half
Quick wash	no	Short	Normal	105	3	no	Long	1600	Full
Super quick wash	no	Short	Normal	105	2	no	Short	800	Half
Wool wash	no	Short	Gentle	85	3	no	Short	800	Third
Hand wash	no	Short	Gentle	85	3	no	Short	800	Third
Rinse	n/a	n/a	n/a	n/a	1	n/a	Long	1600	Full
Spin	n/a	n/a	n/a	n/a	n/a	n/a	Long	1600	Full
Drain	n/a	n/a	n/a	n/a	n/a	n/a	n/a	n/a	Full

NOTE: (1) Model W6641 has a maximum spin speed of 1400 rpm.

## WASH PROGRAM OPTIONS

The table below lists the wash programs along with the options available with each. The options are described in detail in the next table. It's a good idea to scan through the menus a couple of times and

familiarize yourself with the wash programs and options before you make any changes. And remember, it's easy to restore the preset programs.

OPTIONS AVAILABLE WITH EACH WASH PROGRAM

WASH PROGRAMS	Temp Setting (° F) <sup>(1)</sup>	Spin Speed (rpm) <sup>(2)</sup>	OPTIONS (On/Off) <sup>(3)</sup>				
			Pre-Soak	E2:Eco Efficiency	Super Rinse	Anti-Crease	High Water
Heavy	Cold, 85°–205°	400-1600	yes	yes	yes	yes	yes
Normal	Cold, 85°–205°	400-1600	yes	yes	yes	yes	yes
Light	Cold, 85°–205°	400-1600	yes	yes	yes	yes	yes
Synthetic	Cold, 85°–205°	400-800	yes	no	yes	yes	yes
Quick	Cold, 85°–205°	400-1600	yes	no	yes	yes	yes
Super quick	Cold, 85°–205°	400-1600	yes	no	yes	yes	yes
Wool	Cold, 85°–105°	400-800	yes	no	yes	yes	no
Hand wash	Cold, 85°–105°	400-800	yes	no	yes	yes	no

- NOTES:**
- (1) Program times will increase when you select higher wash temperatures. (See "Temperature Control" on page 3.)
  - (2) The maximum spin speed for the W6641 is 1400 rpm. The maximum for the W6661 is 1600 rpm.
  - (3) The table below defines each option.

**WARNING!** Some fabrics may not be able to withstand extremely hot temperatures. Please refer to the "Recommended Wash Temperatures" section on page 6.

OPTION DEFINITIONS

Option	Set this option to "On" to:
Pre-soak	Get a two-hour cold presoak before the wash program starts. For heavily soiled items. Only available with the wash programs.
E2:Eco/ Efficiency	Extend the main wash time by 22 minutes. When used with low wash temperatures (85°–100° F), this program conserves energy but gives the same high level of cleaning. Can also be used with higher temperature settings to clean heavily soiled items. Only available with the Heavy, Normal, and Light wash programs.
Super rinse	Get two additional rinses. Recommended for persons with sensitive skin or allergies. Only available with the wash programs.
Anti-crease	Rotate the drum once every minute at the end of the program to prevent wrinkling. Continues for two hours or until the door is opened.
High water level	Increase the amount of water used for the wash cycle.

**NOTE:** The main wash cycle in a Normal program is 43 minutes.

## DELAYED START

Models W6641 and W6661 have a Delayed Start option that lets you set a delayed start from 1 to 24 hours. This means you can set the washer to start at the most convenient time for you, such as an hour before you arrive home from work. This feature is also useful in

areas where utility companies offer discount rates during off-peak hours.

Refer to page 16 for instructions on how to set a delayed start.

## PROGRAMMING INSTRUCTIONS

Below are the basic instructions for changing a preset wash program. The following paragraphs explain the menus and how to navigate them. You can make one-time program changes, or you can make permanent program changes.

1. Press the button for the preset program you want to change (P1-P4). The program you select will display in the lower left corner of the LCD window.
2. Press MENU until the menu you want to change displays (e.g., programs, temperature, etc.).
4. Press  to scroll through the available options or to toggle between off and on.
5. Press ENTER to save your settings and return to the Main Program screen. The LCD will display your new settings.
6. Press ENTER again to permanently save your settings. (Otherwise, the machine will revert back to the previous settings when the program ends.)

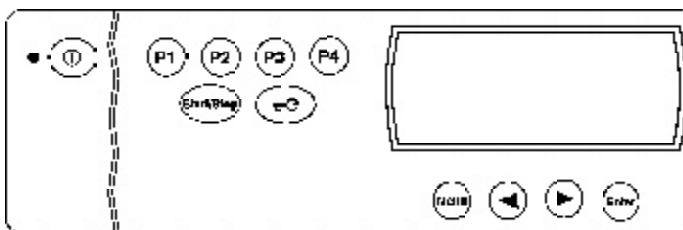

## NAVIGATING THE PROGRAM MENU

The following paragraphs explain how to navigate through the menus and change the preset programs. If you don't want to make changes in all of the menus, continue to press MENU until the one you do want to change displays.

To restore a preset program to its original settings, simply press the button for the preset program you want to restore and hold it down while you press ENTER. The program will revert to its original settings.

We recommend that you make two or three trial changes to understand how easy it is to customize these program.

If you change your mind in the process of changing a program, press the Power button to switch the washer off. When you switch the power back on, the program will be as originally set.

**Remember, the first step to customizing a preset program is to press the button for the program you want to customize (P1-P4).**

### Programs

This lets you set the wash program you prefer. (See the "Available Programs" chart on page 14.) You also use this menu to set the machine for a rinse, spin, or drain program.

1. Press MENU until "Select Program" displays.

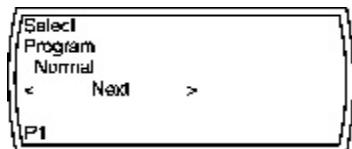

2. Use the Arrow buttons to scroll through the programs (Heavy, Normal, Light, etc.).
3. When your preference displays, press ENTER. The LCD will display the new program setting.
4. Press ENTER again to permanently save your program setting.

### Temperature

This lets you set the wash temperature. The options are 85°, 105°, 120°, 140°, 160°, 175°, and 205°. Only the temperatures available for the wash program you selected will display. (See chart on page 14.)

1. Press MENU until "Select temperature" displays.

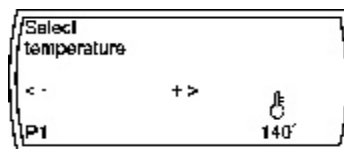

2. Use the Arrow buttons to raise or lower the temperature setting.
3. When the temperature you prefer displays, press ENTER. The LCD will display the new temperature setting.
4. Press ENTER again to permanently save your temperature setting. (See note below.)

**NOTE:** To prevent inadvertent damage to fabrics, the highest temperature you can change permanently is 140°.

## Spin Speed

This lets you set the spin speed. The spin speeds advance in 200 rpm increments. Only the spin speeds available for the wash program you selected will display. (See chart on page 14.)

1. Press MENU until "Select spin speed" displays.

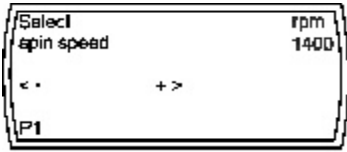

2. Use the Arrow buttons to raise or lower the spin speed setting.
3. When the spin speed you prefer displays, press ENTER. The LCD will display the new spin speed.
4. Press ENTER again to permanently save your program setting.

## Delayed Start

This lets you set a delayed start from 1 to 24 hours. This means you can set the washer to start at the most convenient time for you, such as an hour before you arrive home from work. This feature is also useful in areas where utility companies offer discount rates during off-peak hours.

1. Press MENU until "Select time for delayed start" displays.

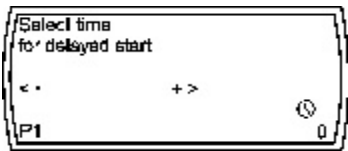

2. Use the Arrow buttons to increase or decrease the delay time. (The numbers indicate hours.)
3. When the number of hours you want to delay starting the machine displays, press ENTER. The LCD will display the delay start time.
4. Press ENTER again to permanently save your program setting.

## Selecting Options

This lets you select Super Rinse, ECO (Economy), Pre-soak, Anti-crease, or High Water level.

1. Press MENU until "Select options" displays.
2. Continue to press MENU to scroll through the options.
3. When the option you wish to select displays, press an Arrow to toggle between Off and On.
4. Press ENTER. The LCD will display the new setting.
5. Press ENTER again to permanently save your setting.

---

## RESTORING A PRESET PROGRAM

To restore a preset program to its original settings, simply press the button for the preset program you want to restore and hold it down while your press ENTER. The program will revert to its original settings.

**NOTE:** If you change the P3 program then decide to restore its original settings, after pressing P3 and ENTER, you must go into the Options menu (see page 14) and turn off Short Spin.

---

## CHANGING THE LANGUAGE ON THE LCD WINDOW

There are eleven languages available for the LCD window:

- |              |               |
|--------------|---------------|
| ◆ English    | ◆ Swedish     |
| ◆ French     | ◆ Danish      |
| ◆ Spanish    | ◆ Norwegian   |
| ◆ Portuguese | ◆ Netherlands |
| ◆ Italian    | ◆ Finnish     |
| ◆ German     |               |

To change the language, follow the steps below:

1. Turn the machine off then on again.
2. Press ENTER five times in succession then press P1 five times. (This must be done within 15 seconds.)
3. When the Language menu displays, press ► to advance to the desired language.
4. Once the correct language displays, press ENTER to program the LCD window to display the language you selected.
5. Press ENTER again to permanently save your program setting.

---

## CHANGING THE TEMPERATURE READOUT ON THE LCD WINDOW FROM CELSIUS TO FAHRENHEIT

You can change the temperature readout on the LCD window from Celsius to Fahrenheit and vice versa. To do this follow the steps below:

1. Turn the machine off then on again.
2. Press ENTER five times in succession then press P2 five times. (This must be done within 15 seconds.)
3. When the Temperature menu displays, press an Arrow button to toggle between Fahrenheit and Celsius.
4. When your preference displays, press ENTER to program the LCD window to display the temperature reading you selected.

### CHILD-SAFE START BUTTON

As a safety measure, you can program the W6641 and W6661 not to start unless the START button is held down for three seconds. To do this, follow the steps below:

1. Turn the machine off then on.
2. Press ENTER five times, then press P3 five times. (This must be done within 15 seconds.)
3. "Delayed start" displays with "0" flashing in the lower right corner. Press the right Arrow button to toggle the display to "3."

### CHILD-SAFE MENU BUTTON

Please note that when you set the child-safe Start button, the Menu button is *automatically* programmed to delay for three seconds before it becomes active. This prevents a child from accidentally changing the program settings.

When you want to change a program, press the Menu button for three seconds to activate the menus. The Menu button will work normally (without the 3-second delay) until you have completed your changes. If it is not pressed for two minutes, it will automatically revert back to the child-safe mode.

### W6641 AND W6661 ERROR MESSAGES

Error messages will display in the LCD window if faults occur while a program is in progress. The table below defines each possible error message.

To remove the message, turn the power off or change the program.

ERROR MESSAGE	SOLUTION
	When this symbol flashes at the lower right corner of the display it merely means the glass door isn't closed securely. Close the door and try again.
0000	If this message flashes at the top right of the LCD window, the machine has failed to spin. This could be because the load is out of balance. Turn the power off then on again. Open the door and redistribute the washing. Run the Spin program again.
Door lock fault	Call a service technician.
Foaming	Run the Rinse program again. Try using less detergent and softener. Use low-sudsing detergents. (See page 8.)
Overflow	Call a service technician
Pressure sensor fault	Call a service technician.
Temperature stop fault	Call a service technician.
Thermistor fault	Call a service technician.
Wash motor fault	Call a service technician.
Water inlet fault	Make sure the water tap is open.
Water outlet fault	Check the pin trap for possible blockage. Make sure the outlet hose isn't kinked.

## CARE AND MAINTENANCE INSTRUCTIONS

### CLEANING THE DETERGENT DRAWER

1. Pull the drawer out as far as it goes then lift it up and pull it out completely, as illustrated.
2. Clean the drawer with a soft brush under warm running water. *Do not put the drawer in a dishwasher.*
3. Replace the drawer by tilting it into position.

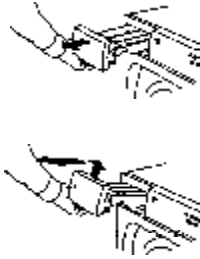

### CLEANING THE PIN TRAP

Your washing machine has a pin trap designed to trap pins, hairpins, coins and similar items. This trap should be cleaned occasionally. To do this, follow the steps below:

1. Make sure as much water as possible is drained out of the tub then turn off the power to the machine.
2. Using the flat edge of the liquid detergent partition piece, a flathead screwdriver or similar item, gently pry open the drain pump cover, as illustrated.
3. There is always a small amount of water in the drain pump area. Before you open the drain cover, place a shallow container, such as a pie pan, on the floor below the drain to catch the water.
4. Pull the small black drain hose loose from its position on the door cover and let the water drain into the pan.
5. Unscrew the pin trap cover and lift it out.

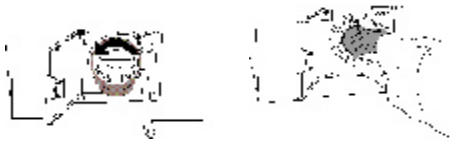

6. You can now clean out any grit or small objects. You should also clean the pump rotor at the back of the pump housing.
7. Replace the drain cover and reconnect the drain hose securely to its position on the door.

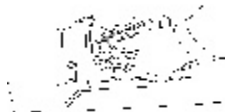

### CLEANING THE CONTROL PANEL

To clean the control panel, use only a warm, damp cloth. To prevent penetration of water into the door lock and electrical components, **never spray water or cleaning solvents on the control panel**. Also, never use abrasive cleaners or scouring pads on the outer surfaces because they will scratch the finish and could remove the writing on the control panel. Some paper towels may also scratch the finish.

#### **WARNING!**

**Never spray clean the control panel. You could damage the electrical components. Also, never use abrasive cleaners, scouring pads or paper towels on the outer surfaces because they will scratch the finish and they could remove the writing on the control panel.**

### REMOVING AN OBJECT FROM BETWEEN THE DRUM AND OUTER CONTAINER

Occasionally, a small item may fall between the drum and the outer container. Such items should be removed because they could corrode and cause rust stains on the laundry. To remove the item, follow the instructions below:

1. Insert a flathead screwdriver in the center hole in the paddle and carefully push it to the left.
2. Grip the paddle with your other hand and pull it toward you.
3. Lift up the paddle and remove the object.

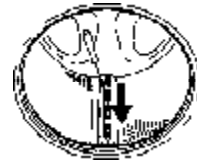
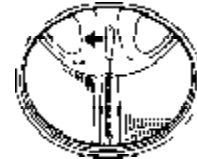

4. Replace the paddle in its fixing hole with the F-mark toward you. Check that the paddle clips are properly located in the slots and slide the paddle toward the back as far as it will go.

### REMOVING HARD WATER STAINS FROM THE DRUM

If you live in an area with hard water, the washer drum may become coated with a grey-white deposit. To remove it, pour about an ounce of citric acid in the drum and run a Normal wash program at 205° F.

## COMMON LAUNDRY PROBLEMS

Most items can be safely washed in an ASKO washing machine. We recommend that you follow the care label instructions as closely as possible for the best cleaning results. Should problems occur, some possible causes and suggested solutions are listed below.

**NOTE:** ASKO has no control over what is put in our appliances once installed in a customer's home. **You are solely responsible for what you wash in your ASKO washing machine.**

ENGLISH

<i><b>Problem</b></i>	<i><b>Possible Cause</b></i>	<i><b>Suggested Solution</b></i>
Graying	<p>Not enough detergent</p> <p>Water not hot enough</p> <p>Improperly prewashed or presoaked</p> <p>Washer overload</p> <p>Soap used in hard water areas</p>	<p>You may need to add slightly more detergent if clothes are heavily soiled, have oily stains, or if your water is very hard.</p> <p>Select a hotter temperature setting for each type of load.</p> <p>Be sure to add a prewash and/or presoak for heavily soiled or oily items.</p> <p>Once wet, the clothes must have room to tumble freely, especially synthetics and permanent press.</p> <p>Be sure you use a laundry detergent, not a "soap." Soap reacts with the minerals in hard water to form a soap curd, which can be deposited on clothes.</p>
Lint or residue left on clothes	<p>Improper sorting of clothes</p> <p>Non-phosphate detergent</p> <p>Fabric softener used improperly</p> <p>Pilling</p>	<p>Separate clothes that shed lint (chenille and terrycloth) from clothes that attract lint (synthetics, corduroy, velveteen).</p> <p>Non-phosphate detergents can combine with minerals in hard water and form a residue which can appear to be lint. Use a low phosphate detergent. If possible, install a water softener.</p> <p>Read labels. Most softeners should only be used in the final rinse. Add softener to the softener compartment. If added to the wash cycle, softeners can have a reaction with detergents, producing a white residue.</p> <p>Pilling, which can look like lint, is produced by normal wear on cotton/polyester blend fabrics. To reduce pilling, wash these fabrics inside out. For the best results, wash in the delicate cycle.</p>
Yellowing	<p>Not enough detergent</p> <p>Water not hot enough</p> <p>Iron or manganese in water</p>	<p>Add slightly more detergent.</p> <p>Use the hottest recommended temperature for each type of load.</p> <p>If possible, install a water filter. A small amount of Calgon or other type of water conditioner added once a week is advisable in hard water areas.</p>
Shrinkage	<p>Improper washing or drying</p>	<p>Follow garment care label instructions carefully (see page 7). Some fabrics will shrink no matter how they are washed. Some may be machine washed but not machine dried.</p>
Knit shrinkage	<p>Overheating</p> <p>Delayed or gradual shrinkage</p> <p>Poor construction</p>	<p>Knits tend to shrink more than woven fabrics. If a knit has been heat-shaped, wash in cool or warm water. Dry with the low setting.</p> <p>This can occur when special stabilizing finishes are reduced from wear or repeated washings. Garment may sometimes be reshaped by pressing after washing and drying.</p> <p>Shrinkage can occur if the knit fabric was not stretched properly by the manufacturer. Press back into shape each time garment is washed and dried.</p>
Fading and discoloring	<p>Improper sorting</p> <p>Crayons or pens in pockets</p> <p>Water too hot</p>	<p>Dark clothes, especially cottons, can bleed excess dyes into wash water. White or light-colored clothes can absorb the dye and discolor. Separate light items from dark items.</p> <p>Always empty all pockets before washing.</p> <p>Cool or cold water is best for retaining dark or bright colors.</p>
Stains	<p>Incorrect water temperature</p> <p>Old stains</p>	<p>Protein stains, such as milk, egg, blood and soy formula should be removed in cold water. Oily stains should be washed in the hottest water recommended for each fabric type.</p> <p>The longer a stain remains on a fabric, the harder it is to remove. Treat stains promptly. Do not set stains by machine drying or ironing fabrics until stains are completely removed.</p>

## COMMON LAUNDRY PROBLEMS (CONTINUED)

<b>Problem</b>	<b>Possible Cause</b>	<b>Suggested Solution</b>
Excessive wrinkling	Machine too full	Permanent press items should be washed in half-loads to prevent wrinkling. If possible, use a slower spin speed.
	Water too hot	Use lower wash temperature settings.
Rips, snags, excess wear	Sharp objects in pockets	Empty all pockets and turn inside out before laundering.
	Hooks, snaps, zippers, buckles	Fasten all hooks, snaps, and zippers before laundering to avoid snags. Remove sharp buckles. Turn knits inside out.
	Harsh chemicals	Before washing, rinse harsh chemicals (such as battery acid, hair care chemicals, cleaning solutions, etc.) from towels and other articles to avoid holes in fabrics. Do not allow these unrinsed items to contact other fabrics.
	Existing rips and tears	Mend all garments before laundering to prevent enlarging of rips.
	Permanent press items	These items may fray at edges from normal wear, not the washer. Wash only in half loads and don't wash in the same load with heavy items, such as towels or jeans.

## TROUBLESHOOTING

If you should experience a problem with your washer, you should review the following list of frequently encountered situations. It could save you the cost and inconvenience of a service call.

Even though the product is under warranty, if the problem is not caused by defective workmanship or materials, you will be charged for a service call. Refer to page 22 to determine what is and is not covered under your warranty. If you're still not sure, contact the ASKO Advisory Center before you call a service technician.

### EMERGENCY DRAIN HOSE

Should you ever need to drain the water from the unit in the event of a power outage, use the drain hose next to the pin trap, as illustrated below.

- Using the flat edge of the liquid detergent partition piece, a flat-head screwdriver or similar item, gently pry open the drain pump cover, as illustrated.



- Before you proceed, place a shallow container on the floor near the drain to catch the water.



- Pull the small black drain hose loose from its position on the door cover and let the water drain into the container.



- When the machine is empty, reconnect the hose securely to its position on the door before you close the drain pump cover.

### BEFORE YOU CALL

Before calling for service or contacting ASKO regarding a warranty issue, make a note of the model name, type number and serial number. The model is on the front of the detergent drawer. The type plate with the type name and serial numbers is located above the glass door. (See illustration below.)

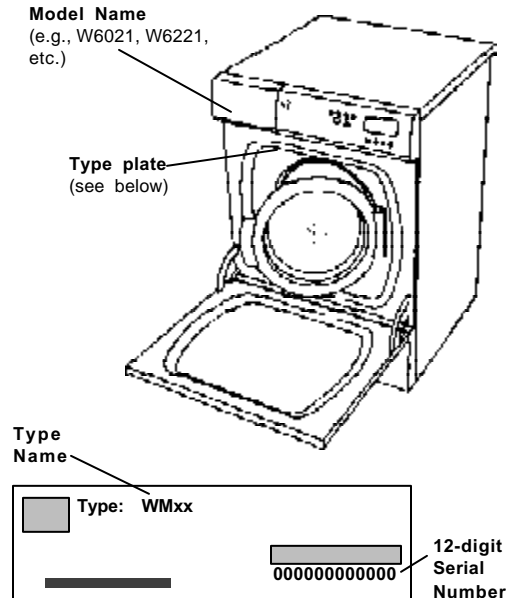

## TROUBLESHOOTING (CONTINUED)

### ***The door won't open.***

- ◆ Make sure the power to the unit is on. If the power is on and the indicator lamp is not lit, there is no power supply. Check that the machine is properly plugged into the electrical outlet. If it is, the fuses may be blown. Call a service technician.
- ◆ Make sure all the water has drained out.
- ◆ If there is no water in the machine and the door won't open in the normal manner, you should be able to open it manually, as follows:
  1. Make sure the tub is as empty as possible and the power is turned off.
  2. Using the flat edge of the liquid detergent partition piece, a flathead screwdriver or similar item, gently pry open the drain pump cover.
  3. Using a T20 or flathead screwdriver, unscrew the red plastic looped handle.
  4. Pull the handle toward you. The door should open.

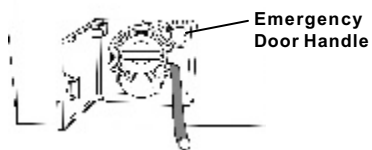

### ***The machine won't start.***

- ◆ Check that the glass door is closed securely.
- ◆ Make sure the power switch is turned on.
- ◆ If the power switch is on and the indicator lamp is not lit, there is no power supply. Make sure the machine is properly plugged into the electrical outlet.
- ◆ Check the house breaker switch/fuses.

### ***The machine doesn't fill.***

- ◆ Make sure the tap to the water supply line is open.
- ◆ Turn off the water supply then disconnect the inlet hose and check to see if the strainer in the inlet connection is blocked.

### ***The machine will not spin.***

- ◆ Make sure the pin trap or outlet hose isn't blocked. Clean if necessary. (See page 18.)
- ◆ Make sure the No Spin option is turned off.
- ◆ If a load is out of balance, the washer will rotate a few seconds to redistribute the load then attempt to spin again. It will do this up to ten times at a high spin speed (1000 rpm or higher). If it still isn't balanced, it will advance the timer with no spin.

### ***Extreme vibration during spin cycle.***

- ◆ Make sure the packaging and shipping supports were removed properly. (See page 4.)
- ◆ Check that the machine is level.
- ◆ Adjust machine feet and tighten locknuts. (See page 4.)

### ***Oversudsing.***

- ◆ Too much detergent could cause suds to backup through the detergent compartment and run down the front of the washer onto the floor. The suds will condensate into water and form a small puddle on the floor. (See page 8 for detergent recommendations.)

### ***Washer stops during cycle.***

- ◆ It is normal for the machine to pause occasionally during operation, especially between cycles and during the delicate wash program.
- ◆ Make sure the No Spin option isn't turned on.
- ◆ If the power switch is on and the indicator lamp is not lit, there is no power supply. Make sure the machine is properly plugged into the electrical outlet.
- ◆ Check the house breaker switch/fuses.

### ***Foam in the final rinse water.***

- ◆ Make sure nothing is blocking the outlet hose.
- ◆ Check for kinks in the outlet hose.
- ◆ Make sure the pin trap isn't blocked. (See page 18.)
- ◆ Make sure that no part of the hose (including any joints) is less than 3/4" (19 mm) in diameter.

### ***Water left in the machine after final spin.***

- ◆ Make sure the No Spin option isn't turned on.
- ◆ Make sure the pin trap isn't clogged. (See page 18.)
- ◆ Make sure the outlet hose isn't clogged.
- ◆ Check for kinks in the outlet hose.
- ◆ Make sure that no part of the outlet hose (including any joints) is less than 3/4" (19 mm) in diameter.

### ***Water leaks.***

- ◆ All hoses should be inspected at least once a year. If they show signs of cracking, they should be replaced.
- ◆ Check to see if hose connections at faucets are tight.
- ◆ Make sure the end of the outlet hose is securely inserted into the drain receptacle.
- ◆ Make sure nothing is caught between the Smart Seal and the tank, such as apron strings, small handkerchiefs, socks, etc.

# ASKO PRODUCT WARRANTY

MODELS W6021, W6221, W6641, W6661

Be sure to complete the Warranty Registration Card you received with your appliance and mail it to AM Appliance Group to validate your appliance warranty.

Cosmetic damage must be reported to your dealer within five days from the date of purchase. After unpacking the washer, thoroughly check the unit for cosmetic damage.

## FOR RESIDENTIAL INSTALLATIONS ONLY

<i>LENGTH OF WARRANTY</i>	<i>AM APPLIANCE GROUP WILL PAY FOR:</i>
<i>Three-Year Full</i> From date of purchase.	ASKO replacement parts and/or repair labor to correct defect in materials or workmanship. Service must be provided by an authorized ASKO service agent.
<i>Fourth &amp; Fifth Year Limited</i> Three year full plus fourth and fifth year limited from date of purchase.	ASKO replacement parts (labor cost not included) for any defective solid-state controls, timers, motors, or pumps. Service must be provided by an authorized ASKO service agent.
<i>Lifetime</i>	ASKO replacement parts (labor cost not included) of the stainless steel tank if it fails to hold water due to a manufacturing defect, such as rusting or cracking. Service must be provided by an authorized ASKO service agent.

## FOR NON-RESIDENTIAL INSTALLATIONS

<i>Six-Month Full Warranty</i> From date of purchase.	ASKO replacement parts and/or repair labor to correct defect in materials or workmanship. Service must be provided by an authorized ASKO service agent.
--	---

## AM APPLIANCE GROUP WILL NOT PAY FOR:

- A. Service calls to:
  1. Correct the installation of the appliance.
  2. Repair damage due to shipment, delivery, installation, misuse or abuse.
  3. Instruct how to use the appliance.
  4. Replace house fuses or correct house wiring.
  5. Correct house plumbing, including drainage problems related to improper installation.
  6. Clean or service air device in drain line.
- B. Repair and/or replacement parts for failure of product if appliance is used for other than home/residential use.
- C. Damage resulting from accident, fire, floods, acts of God, alteration, misuse, abuse, improper installation, or installation not in accordance with local electrical or plumbing codes.
- D. Any shipping costs for parts during the limited warranty period.
- E. Replacement parts or repair labor costs for units operated outside the continental United States.
- F. Pickup and delivery. ASKO washers are designed to be repaired in the home.

## IN NO EVENT SHALL AM APPLIANCE GROUP BE RESPONSIBLE FOR ANY INCIDENTAL OR CONSEQUENTIAL DAMAGES.

Some states will not allow the exclusion or limitation of incidental or consequential damages, so this exclusion or limitation may not apply to you. This warranty gives you specific legal rights and you may also have other rights which vary from state to state.

**For warranty service, contact the dealer from whom you purchased the unit or an authorized ASKO service agent.** Service will be provided during normal business hours. Should you have a service problem that cannot be resolved locally, contact AM Appliance Group at the numbers listed below. Before calling for service or contacting AM Appliance Group regarding a warranty issue, make a note of the model, type name, and serial number (see page 21).

Write to us at:  
AM Appliance Group  
P. O. Box 851805  
Richardson, Texas 75085-1805

Or call our  
Customer Service Center at  
800-898-1879  
or  
972-238-0794

# INDEX

7 button	10, 11	Foam in final rinse	21
800 button	10	Foaming error	17
<b>A</b>		Free-standing installation	5
Allergies	6	<b>G</b>	
Anti-crease option (W6641 & W6661)	14	Glass door	3
Automatic water level control	3	emergency opening	21
<b>B</b>		Graying	19
Bleach	8	Grounding instructions	5
Built-in installation	5	<b>H</b>	
<b>C</b>		Hard water	9
Care and cleaning	18	Hard water stains, removing	18
Care label instructions	7	Hazardous materials	2
Celsius temperature readout, changing	16	HE detergents	8
Changing the LCD readout	16	High water level option (W6641 & W6661)	14
Child safety features	2	<b>I</b>	
Child-safe catch	8	Installation instructions	4, 5
Child-safe menu button (W6641 & W6661)	17	Interrupting a program	3
Child-safe start (W6641 & W6661)	17	<b>K</b>	
Control panel		Knit shrinkage	19
cleaning	18	<b>L</b>	
W6021	10	Languages, changing the LCD	16
W6221	11	Laundry detergents	8
W6641 and W6661	12	Laundry problems	19, 20
Cottons	6, 9	Laundry tips	6
Customizing the preset programs	15	LCD window	12
<b>D</b>		Leveling the machine	4
Delay Start		Linens	6
menu, W6641 & W6661	16	Lint (Pin) trap	18
W6221	11	Lint left on clothes	19
W6641 & W6661	14	Liquid detergent	8
Delicate fabrics	6	Load sizes, recommended	6, 9
Detergent	8, 9	Low-sudsing detergents	8
Detergent drawer	8	<b>M</b>	
cleaning	18	Menus, programming	15
Digital display window	12	<b>N</b>	
Discoloring	19	Navigating the menus (W6641 & W6661)	15
Door		No drain option	14
cleaning	18	No spin option	10, 14
opening	3	No spin/no drain option	11
Door lock fault error	17	Nylon	9
Door open button	10, 11, 13	<b>O</b>	
Drain hose, emergency	20	Operating instructions	
Drain outlet connection	5	W6021	10
Drum	18	W6221	11
Drum paddles, removing	18	W6641 and W6661	12
Dyeing fabric	9	Options	
<b>E</b>		W6021	10
EasyControl Panel	12	W6221	11
Economy option	14	W6641 & W6661	15, 16
Electrical connections	5	Overflow error	17
Emergency door handle	21	Oversudsing	21
Emergency drain hose	20	<b>P</b>	
Enzyme step	3	Paddles, removing	18
Error messages, W6641 & W6661	17	Permanent press items	6
<b>F</b>		Pin trap, cleaning	18
Fabric softener	9	Poison hotline	2
Fabrics		Polyester blends	9
dyeing	9	Powder detergents	8
recommended wash temps	9	Power button	10, 11, 12
Fading and discoloring	19	Preparing the laundry	6
Fahrenheit readout W6641 & W6661	16		
Fluorescent colored fabrics	6		

---

## INDEX (continued)

Preset programs		
restoring	16	
Preset Programs (W6641 & W6661)	13	
Problems (e.g., stains, etc.)	19, 20	
Program buttons (W6641 & W6661)	13	
Program changes, temporary	13	
Program menu (W6641 & W6661)	15	
Programming		
Celsius or Fahrenheit	16	
Child-safe start	17	
Language	16	
Menus, W6641 & W6661	15	
Programming instructions		
W6641 & W6661	15	
Programs	10, 11	
W6021	10	
W6221	11	
W6641 & W6661	13	
<b>Q</b>		
Quick main wash option	14	
<b>R</b>		
Rayon and acetate	9	
Recommended detergents	8	
Recommended wash temps	9	
Restoring preset programs	16	
Rinse cycles	3	
Rips	20	
<b>S</b>		
Safety instructions	2	
Sensitive skin, advice	6	
Sensor Level Control	3	
Serial number location	20	
Service	22	
Shipping supports	4	
Short spin option	14	
Shrinkage	19	
Silk	9	
Snags	20	
Solutions to problems	20	
Sorting the laundry	6	
Specifications	4	
Spin options	3, 9	
Spin Speed (W6641 & W6661)		
menu	15	
Spin speed (W6641 & W6661)		
temporarily changing	13	
Spin speed control, W6221	11	
Spray cleaner warning	18	
Stacked installation	5	
Stains	19	
Start/Stop button	10, 11, 12	
Stopping a program	3	
Super Rinse option	3, 10, 11, 14	
<b>T</b>		
Temperature		
control	3	
menu (W6641 & W6661)	15	
settings (W6641 & W6661)	13	
Temperature stop error	17	
Temporary program changes		
(W6641 & W6661)	13	
Thermistor error	17	
Troubleshooting	20	
Type plate location on unit	20	
<b>V</b>		
Vibration, extreme	21	
<b>W</b>		
Warranty information	22	
Wash motor error	17	
Wash programs	9	
options, W6641 & W6661	15	
W6021	10	
W6221	11	
W6641 and W6661	13	
Wash temperature control	3	
Wash temperatures	9	
Washer features	3	
Washing special items	19, 20	
Water		
hardness	9	
inlet error	17	
leak	21	
level control	3	
outlet error	17	
supply connection	4	
Wear	20	
Wool and wool blends	9	
Wrinkling	20	
<b>Y</b>		
Yellowing	19	