

This Owner's Manual is provided and hosted by [Appliance Factory Parts](http://ApplianceFactoryParts.com).

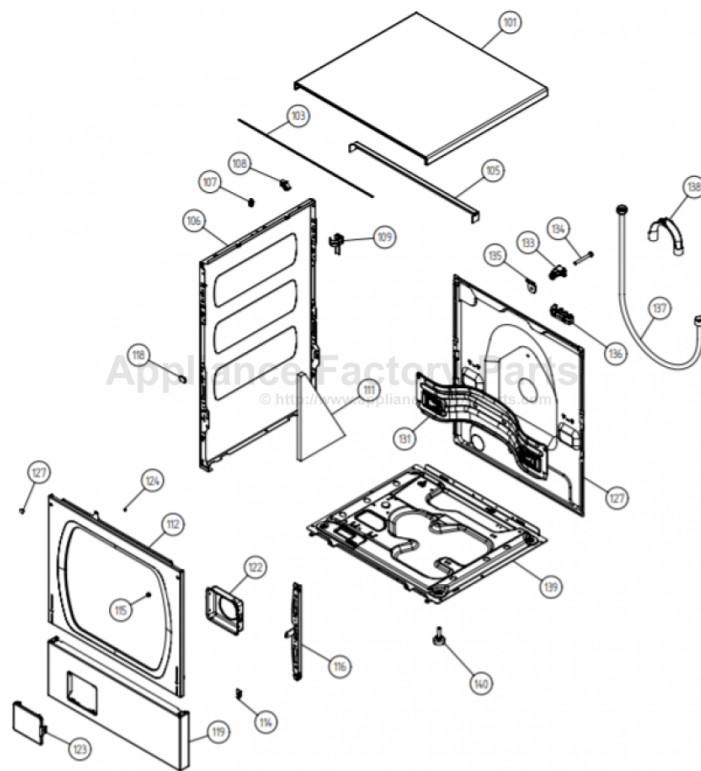

ASKO W6461TI Owner's Manual

[Shop genuine replacement parts for ASKO W6461TI](#)



[Find Your ASKO Washer Parts - Select From 53 Models](#)

----- Manual continues below -----



USE AND CARE GUIDE

SAVE THESE INSTRUCTIONS FOR FUTURE REFERENCE

IMPORTANT!
**To get the best performance from
your washer, read all operating
instructions before using it for the
first time.**

WASHER

CONTENTS

IMPORTANT SAFETY INSTRUCTIONS	2
CHILD SAFETY FEATURES	2
ASKO WASHER FEATURES	3
INSTALLATION INSTRUCTIONS	4
PREPARING THE LAUNDRY	6
THE DETERGENT DRAWER	8
DETERGENTS	8
FABRIC SOFTENERS	9
FABRIC DYEING	9
RECOMMENDED WASH TEMPERATURES	9
W6021 OPERATING INSTRUCTIONS	10
W6461 OPERATING INSTRUCTIONS	12
CARE AND MAINTENANCE INSTRUCTIONS	15
COMMON LAUNDRY PROBLEMS	16
TROUBLESHOOTING	17
ASKO PRODUCT WARRANTY	19
INDEX	22

IMPORTANT SAFETY INSTRUCTIONS

To reduce the risk of fire, electric shock, or injury to persons when using your appliance, follow basic precautions, including the following:

- ◆ Read all instructions before using the appliance.
- ◆ Do not run appliance while you are out of the home.
- ◆ Do not wash or dry articles that have been previously cleaned in, washed in, soaked in, or spotted with gasoline, dry-cleaning solvents, cooking oils, or other flammable or explosive substances because they give off vapors that could ignite or explode.
- ◆ Do not allow children to play on or in the appliance. Close supervision of children is necessary when the appliance is used near children.
- ◆ Before the appliance is removed from service or discarded, remove the door to the washing compartment.
- ◆ Do not reach into the appliance if the drum is moving.
- ◆ Do not install or store this appliance where it will be exposed to the weather.
- ◆ Do not tamper with controls.
- ◆ Do not repair or replace any part of the appliance or attempt any servicing unless specifically recommended in the user-repair instructions or in published user-repair instructions that you understand and have the skills to carry out.
- ◆ Do not add gasoline, dry-cleaning solvents, or other flammable or explosive substances to the wash water. These substances give off vapors that could ignite or explode.
- ◆ Under certain conditions, hydrogen gas may be produced in a hot water system that has not been used for 2 weeks or more. HYDROGEN GAS IS EXPLOSIVE. If the hot water system has not been used for such a period, before using a washing machine or combination washer-dryer, turn on all water faucets and let the water flow from each for several minutes. This will release any accumulated

hydrogen gas. As the gas is flammable, do not smoke or use an open flame during this time.

WARNING!

This appliance must be properly grounded.

GROUNDING INSTRUCTIONS

A) Grounding instructions for a grounded, cord-connected appliance

In the event of malfunction or breakdown, grounding will reduce the risk of electric shock by providing a path of least resistance for electric current. This appliance is equipped with a cord having an equipment-grounding conductor and a grounding plug. The plug must be plugged into an appropriate outlet that is properly installed and grounded in accordance with all local codes and ordinances.

WARNING!

Improper connection of the equipment-grounding conductor can result in a risk of electric shock. Check with a qualified electrician or service representative or personnel if you are in doubt as to whether the appliance is properly grounded.

Do not modify the plug provided with the appliance. If it will not fit the outlet, have a proper outlet installed by a qualified electrician.

B) Grounding instructions for a permanently connected appliance:

This appliance must be connected to a grounded metal, permanent wiring system, or an equipment-grounding terminal or lead on the appliance.

NOTE: This manual does not cover every possible condition and situation that may occur. Use common sense and caution when installing, operating, and maintaining any appliance.

CHILD SAFETY FEATURES

CHILD-SAFE DETERGENT DRAWER

ASKO washers have a child-safety catch on the detergent drawer that can be engaged to prevent a child from opening the drawer and possibly coming into contact with the detergent or fabric softener. Refer to page 8 for instructions on how to engage the child-safety catch.

CHILD-SAFE TEMPERATURE KNOB

Model W6021 has a child-safety catch that can be engaged to prevent children from tampering with the temperature knob. The catch is located below the temperature knob behind the edge of the control panel. To engage it, insert a flathead screwdriver in the slot on the catch. Press upwards as you turn the catch clockwise. When you release the catch it should protrude slightly below the control panel.

Once the catch is engaged, you must hold it up as you turn the temperature knob to the desired setting.

CHILD-SAFE START

You can program Model W6461 not to start unless the Start button is held down for three seconds. This is to

prevent children from inadvertently starting the machine. Refer to the operating instructions for these models to program this safety feature.

MORE CHILD-SAFETY TIPS

- ◆ Laundry detergents are corrosive, so always keep them out of reach of children.
- ◆ Should a child swallow detergent, give plenty to drink immediately, i.e., one or two glasses of milk or water. Do not try to induce vomiting. Seek medical advice immediately: **1-800-POISON1**
- ◆ Always close the door and start the appliance as soon as you put in the detergent.
- ◆ Always turn the power off to the machine when it is not in use.
- ◆ Always keep small children away from the machine when it is open. There may be some detergent residue left inside the machine.
- ◆ If laundry detergent gets in someone's eyes, rinse them with plenty of water for at least 15 minutes.

ASKO WASHER FEATURES

Your new energy-efficient ASKO washer is designed to give you maximum cleaning performance using less water, energy and detergent. To make the most of the washer's functions and features, we recommend that you read this manual carefully before using your machine for the first time. For operating instructions, refer to pages 10 through 20.

Below is an illustration of the external parts and features of your ASKO washer.

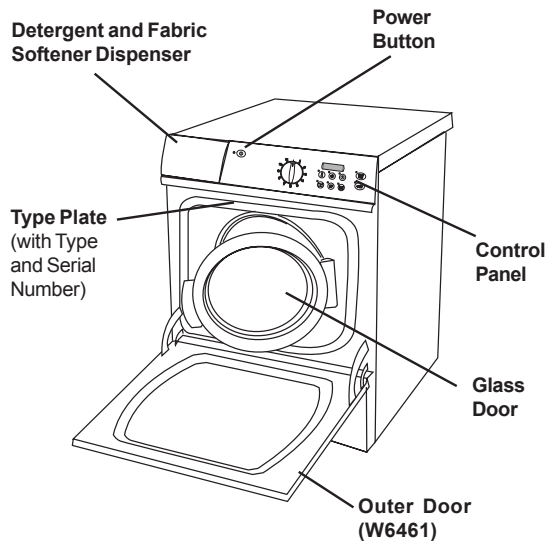

SENSOR LEVEL CONTROL (SLC)

ASKO washers do not need high, medium, or low water level settings to compensate for different sized loads. ASKO units have a consumption sensor—Sensor Level Control—that ensures the correct amount of water is pumped into the machine for any size load. It even compensates for fabric saturation, letting in more water if needed. This eliminates worry about selecting the right water level setting for each laundry load.

TEMPERATURE CONTROL

Because wash water temperature is a major factor in getting laundry clean, ASKO washers have built-in heating elements and a sensor that keeps the temperature to within $\pm 1^\circ$ F of the selected program temperature.

ASKO washers are programmed not to advance in a cycle until the selected water temperature is reached, so the length of the cycles may vary, depending upon the household cold water temperature, the amount of laundry in the washer, and the wash temperature setting.

ENZYME STEP

To successfully remove all dirt and stains from fabric, the enzymes in your detergent need to work at a temperature between 105° and 140° F for a longer time period. This longer wash cycle gives the enzymes in the detergent ample time to remove stains, eliminating the need for stain sprays and spot removers.

MORE RINSE CYCLES

Most washers have only two or three rinse cycles; some have an option to add a fourth. ASKO washers have *five* rinses and a Super Rinse option that adds two more. ASKO washers get the soil and detergent out of your laundry that most other washers leave in. That's why your whites will remain white and your colored fabrics will remain bright.

SUPER RINSE OPTION

This option is designed for people with sensitive skin or who are allergic to detergents. It can also be used for large, heavily soiled loads.

SPIN OPTIONS

ASKO washers have faster spin speeds than most other washers, which may decrease the time it takes to dry your laundry. The spin speeds range from 400 rpm to 1600 rpm, depending on the model. You can also turn the spin cycle off.

INSTALLATION INSTRUCTIONS

Read these instructions carefully and completely before you install the machine. The installation should be carried out by a qualified person who is familiar with all local codes and ordinances for electrical and plumbing connections.

SPECIFICATIONS

Height	33-1/2"–34-1/2 (850–876 mm)
Width	23-7/16" (595 mm)
Depth	W6021/W6461: 24-7/16" (620 mm)
Weight	167 lbs. (73 kg)
Rated load	See data plate
Supply voltage	Single-phase 230 V, 60 Hz
Heating element	2000 W
Fuse	15 A (2 internal fuses)

IMPORTANT NOTE:

Cosmetic damage must be reported to your dealer within five days from the date of purchase. After unpacking the washer, thoroughly check the unit for cosmetic damage.

Drum and Barrel	Stainless steel
Outer casing	Stove-enamelled hot-dipped galvanized steel or stainless steel
Mounting	Four adjustable rubber-covered feet
Inlet supply hose	5 ft. (1.5 m) PEX tubing with brass ferrules
Supply pressure	15–142 PSI
Outlet hose	5.5 ft. (1.7 m) polypropylene hose, 3/4" ID

REMOVING THE SHIPPING SUPPORTS

The machine is transported with three shipping supports, as illustrated below. These supports hold the tub in place during shipment. When you unpack the machine, you must remove these supports.

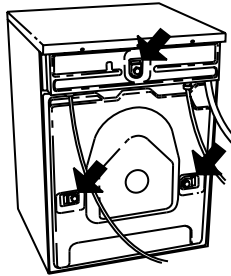

You must remove the shipping supports before you install the washer.

To remove the shipping supports, follow the instructions below:

1. Unscrew the 5/8" (12 mm) bolts holding the supports in place and remove the bolts.

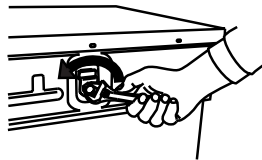

2. Push the rubber spacer up then pull it out of the slot.

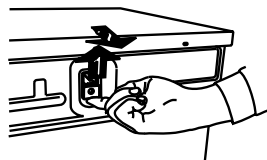

3. Rotate the spacer so that the extruded end points toward the machine.



4. Insert it into the slot and push down to lock it into position.

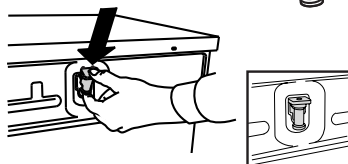

LEVELING THE MACHINE

It is important that the machine is level so it won't vibrate excessively during the spinning cycles. Each foot on the washer is adjustable, so you can level the washer on any surface. Once it is level, securely tighten the lock nuts on the feet to prevent excessive vibration during the spin cycles.

Be sure to tighten the lock nuts securely when you level the machine.

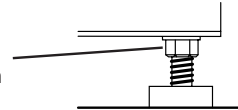

WATER SUPPLY CONNECTION

Because ASKO washers have their own heating element, you only need to have a cold water inlet. The connection should be made by someone who is sufficiently skilled. Use the hose supplied with the washer. (The inlet hose is marked for proper connections.)

Water pressure must be in the range of 15–146 PSI.

A tap should be fitted on the water supply pipe.

If a new supply pipe has been installed for the washer, it should be flushed thoroughly to remove any foreign particles that might clog the strainer in the water inlet.

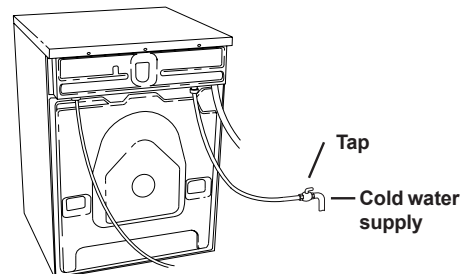

NOTE: If unit is installed on a second story, follow local building codes. We recommend a drip pan be installed.

DRAIN OUTLET CONNECTION

The machine is supplied with the outlet hose already attached. The hose should be extended over a suitable sink edge or drain pipe at a height of 24" to 36" (610 mm to 914 mm) above the bottom of the unit. (The lower height is preferable.) Make sure that the hose is not kinked.

NOTE: If the hose is extended, the internal diameter of the coupling must not be less than 1/2".

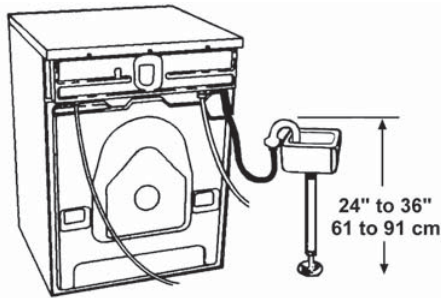

WARNING! Do not extend the drain hose higher than 36" (914 mm) from the bottom of the unit.

ELECTRICAL CONNECTIONS

The machine is delivered ready-fitted with a plug and is intended for connection to an ASKO Dryer, which is equipped with a matching receptacle. The plug supplied with the washer can only be used with an ASKO Dryer. If the washer is used separately or with another dryer, it must be on a separate 220 V single-phase circuit.

If the machine is to be used in a wet area, the supply must be protected by a residual current device.

As supplied: 230 V, 60 Hz
2000 W heating element
15 A fuse required

WARNING! Connection to a permanently wired supply point must be made only by a qualified electrician.

GROUNDING INSTRUCTIONS

This appliance must be grounded. In the event of malfunction or breakdown, grounding will reduce the risk of electric shock by providing a path of least resistance for electric current. This appliance is equipped with a cord having an equipment-grounding conductor and a grounding plug. The plug must be plugged into an appropriate outlet that is properly installed and grounded in accordance with all local codes and ordinances.

WARNING! Improper connection of the equipment-grounding conductor can result in a risk of electric shock. Check with a qualified electrician or serviceman if you are in doubt as to whether the appliance is properly grounded.

Do not modify the plug provided with the appliance. If it will not fit the outlet, have a proper outlet installed by a qualified electrician.

FREESTANDING INSTALLATION

The washer can be placed next to the dryer. It is essential that the machine is leveled and the locknuts tight to prevent excessive vibration during the spin cycles. Also be sure to leave a minimum of 1/2" (12 mm) of space between the washer and the dryer.

The height adjustment for the washer is 33-1/2" to 34-1/2" (850 mm to 876 mm). Do not raise it higher than 34-1/2".

STACKED INSTALLATION

ASKO washers should never be stacked on a counter or a dryer. You can, however, stack an ASKO dryer on an ASKO washer. Refer to your *Dryer Use and Care Guide* for instructions on how to do this.

BUILT-IN INSTALLATION

ASKO washers can be installed beneath a cabinet or worktop with a height of 34-1/2" (876 mm). There must be a gap of about 1/2" (12 mm) all around the machine, including between the rear edge of the machine top panel and the back wall. The opening width must be at least 24-1/2" (622 mm).

Space must also be available for the inlet and drain hoses. See the diagram below for measurements and positions.

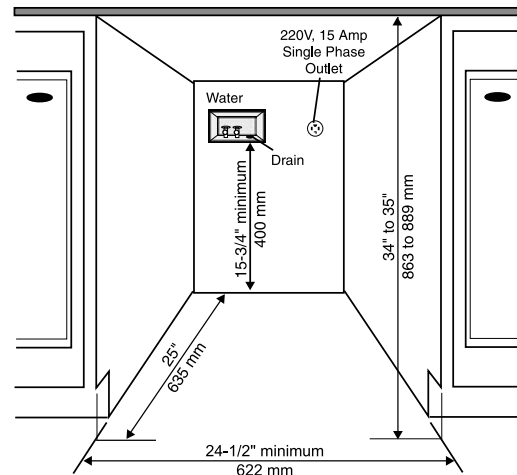

If the drain outlet is higher than 24", the connections will need to be recessed.

PREPARING THE LAUNDRY

We believe ASKO washers clean better than any other washer available on the market. With proper attention to how you prepare your laundry items for washing and drying, your wardrobe and linens will look like new for years.

SORTING THE LAUNDRY

Properly sorting your laundry is a very important factor in ensuring that your clothing and linens look new for a long time. Another important factor is properly following the care label instructions (see next page).

Below are some basic rules for sorting your laundry:

Sort by

1. Fabric color

Whites; pastels and medium colors; bright colors; dark colors

2. Amount of soil

Heavily soiled items should be washed separately from lightly soiled items.

3. Fabric Type

Delicates should be washed separately. You should also consider separating fabrics that tend to shed lint (e.g., cotton, chenille, and terrycloth) from fabrics that attract lint (e.g., permanent press, corduroy, velveteen, flannel and synthetics).

IMPORTANT NOTE:

If the care label says "Wash Separately," the fabric is likely to lose color (excess dye) for the first few washings. To minimize the possibility of the color transferring to white or lighter colored items, wash new colored garments with items of similar color or separately. Bright reds and oranges on cottons are the dyes most likely to transfer colors to the wash load. Fluorescent colors should always be washed separately.

RECOMMENDED LOAD SIZES

To reduce wrinkling, you should determine the load size based on the type(s) of fabrics being washed. The chart below gives recommended load sizes for different fabrics.

Load Size	Fabrics
Full ●	Cotton, linen
Half ◐	Perm press, synthetics, acrylics
Third ○	Special finish cottons, machine washable wool, silk, acetates

Cotton and Linen Fabrics

These items should be washed in full loads because the tumble action of the tub along with the gentle rubbing and lifting and falling movement of the clothes gives the best cleaning result.

Permanent Press Fabrics

These items need more room to move freely during washing for the most wrinkle-free results. Therefore, fill the machine only half full for permanent press loads. These items should have only a brief spin cycle and they should be removed promptly from the washer and put directly into the dryer or hung to dry.

Delicate Fabrics

More delicate fabrics, such as machine washable wool and silk, should only be washed in one-third size loads for the best results.

ADVICE FOR PERSONS WITH SENSITIVE SKIN

ASKO washers are ideal for people allergic to detergent. Our Heavy, Normal and Light wash programs have five rinse cycles and a Super Rinse option that adds two more rinses. This ensures that all the detergent residue is rinsed out of your laundry.

As an extra precaution, you should use mild detergents and be careful not to use too much.

GENERAL LAUNDRY ADVICE

- ◆ Always follow the care label instructions (see page 7).
- ◆ Remove any sharp ornaments, pins or buckles to prevent snags.
- ◆ Empty pockets and turn them inside out.
- ◆ Close zippers and hooks to prevent snagging.
- ◆ Tie sashes and strings to prevent tangling.
- ◆ Mend any small rips to prevent them from enlarging.
- ◆ Turn colored cotton garments, velvet and finer knitwear inside out before washing.
- ◆ Turn delicate items, sweaters and T-shirts inside out to prevent pilling and to protect the prints.
- ◆ Prewash severely soiled items.
- ◆ Wash colored fabrics separately the first time.
- ◆ Thoroughly rinse down items, such as comforters (Super rinse).
- ◆ Use fabric softener to eliminate static electricity in synthetic garments and to soften cotton.

CARE LABEL INSTRUCTIONS





































Most clothes and other washable items have permanent care labels. *Read these labels carefully!* Care label instructions and warnings should be followed for the best cleaning results.

The table below defines the symbols used on fabric care labels. (NOTE: Some manufacturers may use slightly different symbols.)

As an example, the symbols in the label illustrated below mean: wash in warm water on permanent press setting. Use non-chlorine bleach. Dry on permanent press setting. Iron on low temperature setting.



CARE LABEL SYMBOLS

<p>WASH CYCLE</p> <ul style="list-style-type: none">  Normal wash cycle  Permanent Press or Wrinkle Resistant setting  Gentle/Delicate setting  Hand wash only  Do not wash  Do not wring. Hang dry, drip dry, or dry flat <p>WASH WATER TEMPERATURE</p> <ul style="list-style-type: none">  Maximum water temp 200° F/95° C  Maximum water temp 160° F/70° C  Maximum water temp 140° F/60° C  Maximum water temp 120° F/50° C  Maximum water temp 105° F/40° C  Maximum water temp 85° F/30° C <p>BLEACH INSTRUCTIONS</p> <ul style="list-style-type: none">  Any bleach when needed  Only non-chlorine bleach  Do not bleach <p>DRY CLEAN SYMBOL</p> <ul style="list-style-type: none">  Dry clean only 	<p>TUMBLE DRY CYCLE</p> <ul style="list-style-type: none">  Machine dry  Normal setting  Permanent Press or Wrinkle Resistant setting  Gentle or Delicate setting  Do not tumble dry <p>TUMBLE DRY HEAT SETTING</p> <ul style="list-style-type: none">  Any heat  High heat  Medium heat  Low heat  No heat/Air fluff <p>SPECIAL DRYING INSTRUCTIONS</p> <ul style="list-style-type: none">  Line dry or hang to dry  Drip dry (do not spin or wring)  Dry flat  Dry in shade <p>IRONING INSTRUCTIONS</p> <ul style="list-style-type: none">  Ironing is necessary  High temperature setting  Medium temperature setting  Low temperature setting  Do not iron or press with heat  Iron without steam
--	---

THE DETERGENT DRAWER

The detergent drawer on ASKO washers automatically dispenses the detergent and fabric softener at the appropriate times. Simply pour the measured amounts of detergent and softener into the proper compartments (as illustrated) and close the drawer.

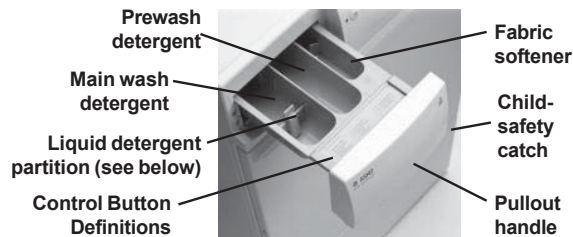

NOTE: To avoid oversudsing, do not put detergent in the prewash compartment unless you are using one of the Heavy wash programs which has a prewash cycle.

Control Button Definitions

Inside the detergent drawer is a plate that illustrates the buttons on the control panel and defines each button. Refer to the "Operating Instructions" in this guide for your specific model for more details regarding the control buttons.

Child-Safety Catch

All ASKO washers have a child-safety catch on the detergent drawer that can be engaged to prevent a child from opening the drawer and possibly coming into contact with the detergent or fabric softener.

The safety catch is the red plastic piece on the back right side of the pull-out handle. To engage the catch, open detergent drawer a little then pull the catch forward and release it. Once the catch is engaged, you must push it to the left each time you open the detergent drawer.

To disengage the catch, push it to the left then back.

DETERGENTS

Laundry detergents are available in low-, normal- and high-sudsing formulas. A detergent's ability to clean is not relative to the amount of suds it produces. Excess suds in a front-loading washer actually interfere with the cleaning because they cushion the tumbling action. Also, high-sudsing detergents are more difficult to completely rinse out.

The use of anything other than a low-sudsing detergent can cause severe oversudsing, which could cause suds to backup through the detergent compartment and run down the front of the washer onto the floor. If oversudsing occurs, run the wash through one or more rinse programs until all items are thoroughly rinsed. Remove the laundry then run the washer through a Normal wash program to get rid of any remaining detergent.

We recommend that you don't use bleach in your ASKO washer. The tumbling wash action, temperature control options, extended wash times and proper amount of detergent are sufficient to remove most stains.

LIQUID DETERGENTS

We don't recommend liquid detergents because they tend to produce more suds than powder detergents when used in water temperatures of 150° F or higher. If you should try a liquid detergent, start with a very small amount, such as **1 to 2 tablespoons**. Also, liquid detergent can be used for all programs without prewash, so add it into the main wash compartment.

Should you prefer to use a liquid detergent, we have provided a partition piece with the detergent drawer specifically for use with liquid detergents. Insert the partition in the slot at the back of the main wash compartment before you pour in the liquid detergent.

NOTE: The partition piece is packaged under the detergent drawer.

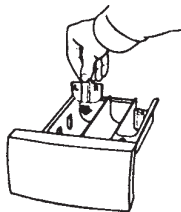

RECOMMENDED POWDER DETERGENTS

ASKO washers use 50% to 75% less detergent than most other washers. This is because of their low water consumption and the fact that all the wash water is repeatedly circulated through the laundry, ensuring that all the detergent is fully utilized. We recommend that you use powder detergents made specifically for front-loading washers. These are sometimes called HE (High-Efficiency) detergents. Listed below are some low-sudsing powder detergents that have been successfully tested in ASKO washers:

- ◆ Fab
- ◆ All
- ◆ Fresh Start
- ◆ Amway SA8
- ◆ Tide HE
- ◆ Wisk HE

We recommend that you do not use any powder detergent that doesn't wash completely out of the detergent drawer.

AMOUNT OF DETERGENT TO USE

The amount of detergent needed varies among the different brands, but for most detergents, **you need only one or two tablespoons**. Using too much detergent can result in detergent residue being left in your clothes, which can cause them to appear gray or dingy. You should start with a small amount of detergent and increase it only if the cleaning results are unsatisfactory.

Additionally, you should never put detergent in the prewash compartment unless you are using a wash program that has a prewash cycle. This could cause excess foaming, which could damage the machine.

The amount of detergent needed can also depend on the hardness of the water in your area. See the "Detergent Amounts Based on Water Hardness" section on the next page for more details.

Detergent Amounts Based on Water Hardness

The amount of detergent needed can vary due to differences in water hardness. To determine the water hardness in your area, contact your local water utility or area water softening company. The harder the water, the more detergent you may need. Refer to the chart below for the recommended detergent amounts based on water hardness. Remember, you should adjust the amount of detergent you use by small amounts until you find the correct amount.

Note that 12 grains and higher is extremely hard water

and detergent alone may not be enough. You may need to use a water softener to maximize the performance of your washer. Also, in areas with extremely hard water (9+) you may need to wash at lower temperatures to prevent hard water deposits from forming in the tank and wash system.

Different brands of detergent have different amounts of phosphorous for softening water. If you have hard water and use a detergent with less than 8.7% phosphorous content, you may need to use more detergent or use a detergent with a higher phosphorous content.

Recommended Detergent Amounts Based on Water Hardness

Water Hardness	Detergent Amounts	
	Prewash	Main Wash
Soft (0-3 grains per gal.)	1 teaspoon	1 to 1-1/2 tablespoons
Medium (4-8 grains per gal.)	1 teaspoon	1 to 2 tablespoons
Hard (9+ grains per gal.)	1 teaspoon	2 to 3 tablespoons

FABRIC SOFTENERS

Fabric softeners are available in several concentrations. We recommend that you use only two tablespoons of

fabric softener. If more softening is desired, try adding slightly more the next time.

FABRIC DYEING

To dye fabrics in your washing machine, pour the dye directly into the drum, not in the detergent compartment. Select Normal wash with the Super Rinse option and use the temperature recommended on the dye package. If you're dyeing polyester, select a spin speed of 800

rpm.

After you have removed the dyed items, be sure to clean the drum before you wash a load of laundry. Do this by running the empty machine through a Normal wash program using the normal amount of detergent.

RECOMMENDED WASH TEMPERATURES

Different fabrics require different wash temperatures. The table below gives recommended wash temperatures for different fabrics as well as recommended programs, load

sizes, and spin options. These are only suggestions. We recommend that you always refer to the care label instructions (see page 7).

Fabric Type	Wash Temp.	Wash Program	Load Size ⁽¹⁾	Spin Options ⁽²⁾
White cotton w/out elastic and/or decorative trim	140–205° F	Sani	Full	Long spin, high rpm
White cotton w/elastic and/or decorative trim	120–140° F	Heavy	Full	Long spin, high rpm
Colored cotton	120–140° F	Normal plus	Full	Long spin, high rpm
Linen (white and colorfast)	120–140° F	Normal plus	Half	Short spin, low rpm
Cotton/polyester blends	105–120° F	Normal/Perma press	Half	Short spin, low rpm
Polyester/acrylic blends	105–120° F	Normal/Perma press	Half	Short spin, low rpm
Rayon and acetate	105° F	Delicate, Hand/Wool	Half	Short spin, low rpm
Washable silk and nylon	85° F (cold)	Delicate, Hand/Wool	Third	Short spin, low rpm
Washable wool and wool blends	85–105° F (cold)	Delicate, Hand/Wool	Third	Short spin, low rpm
Handwash wool & silk ⁽³⁾	85° F (cold)	Delicate, Hand/Wool	Third	Short spin, low rpm

NOTES:

- (1) The load size should be determined by the type of fabric being washed. (See page 6.)
- (2) Spin speed options are not available on all models.
- (3) Some hand-washable wool and silk items should not go through a spin cycle. These items should be removed from the washer then pressed out in a terry towel to remove excess water before being hung up or laid flat to dry.

W6021 OPERATING INSTRUCTIONS

WARNING! To reduce the risk of electric shock or injury to persons, read the "Important Safety Instructions" section on page 2 before operating this appliance.

THE CONTROL PANEL

Door Open Button

Press to open the glass door. (Please note that the unit must be at the end of a program to open the glass door.)

The door will open automatically once a program is completed.

Temperature Control

Turn clockwise to select the wash temperature.

Program Control

Turn to select a program. (Please note that the dial does not move as the program advances.)

Power Indicator Light
Glowes when the power is turned on.

Power Button
Press to turn on power to the machine.

Start/Stop Button
Press to start or stop/ interrupt a program.

Extra Rinses Button
Press to program seven rinses.

No Spin/No Drain
Press to omit the spin and final drain cycles.

800 RPM Spin Button
Press to reduce spin speed from 1200 rpm to 800 rpm.

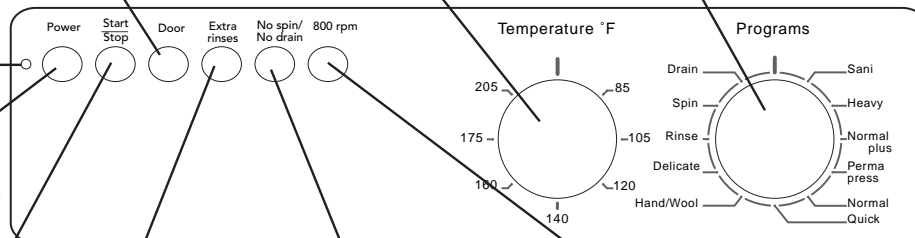

POWER BUTTON ①

The Power button turns the power to the machine on and off. When the power is on, the power indicator light glows red. The power must be on before you can open the door, set the programs or start the machine.

START/STOP BUTTON

Once you've selected the program and options, press this button to start the washer.

To stop the washer during a program, press and hold this button down until the unit stops (about 3 seconds).

DOOR OPEN BUTTON

The door will open automatically once a program is completed. Pressing this button will open the glass door as long as the power to the unit is on, the machine is at the end of a program, and there is no water in the machine.

NOTE: For instructions on how to open the door manually in case of power failure, see page 24.

PROGRAM CONTROL KNOB

Turn this knob to the desired program. The table on the following page defines each program.

TEMPERATURE CONTROL KNOB

Turn this knob clockwise to the desired wash temperature. Always refer to the garments' care labels for recommended wash temperatures.

Please note that the wash temperature for the Hand/Wool Wash and Delicate programs will not heat higher than 105° F.

OPTION BUTTONS

Extra Rinses

Press this button to add two rinses. Press the button again to turn this option off. (This option cannot be cancelled after the main wash water has pumped out.) This option is recommended for persons with sensitive skin or allergies.

No Spin/No Drain

Press this button to omit the spin cycles in all programs along with the final drain. If you select this option, the unit will stop with water in the drum, so you will have to run the Drain program. The door will open automatically after the Drain program is completed.

800 RPM

Press this button to reduce the spin speed from 1200 rpm to 800 rpm. This option is for delicate fabrics that should not be spun at high speeds. Note: This option does not apply to the Rinse and Spin programs.)

CANCELLING A PROGRAM

To cancel a program after it has started, press and hold the Start/Stop button until the unit stops. If there is water in the unit, you will have to turn the Program Control knob to Drain then press Start. The water will drain and the unit will stop in 30 to 45 seconds. The door will open automatically after the Drain program is completed.

W6021 PROGRAMS AND OPTIONS

Your ASKO washer has several programs and options specifically designed to give you the cleanest laundry possible. The tables below define each program.

Program	Pre-wash	Main Wash	Wash Action	Temp. ⁽¹⁾ (° F)	# Rinses	Int. Spin	Final Spin	Spin Speed	Load Size
Sani	yes	Long	Normal	140	5	2	Long	1200	Full
Heavy	no	Long	Normal	140	5	2	Long	1200	Full
Normal plus	no	Short	Normal	105	5	2	Long	1200	Full
Perma press	no	Short	Normal	105	3	no	short	800	Half
Normal	no	Short	Normal	105	3	no	Long	1200	Full
Quick	no	Short	Normal	105	2	no	Short	800	Half
Hand/Wool	no	Short	Gentle	85 ⁽²⁾	3	no	Short	800	Third
Delicate	no	Short	Gentle	85 ⁽²⁾	3	no	Short	800	Third
Rinse	n/a	n/a	n/a	n/a	1	n/a	Long	1200	Full
Spin	n/a	n/a	n/a	n/a	n/a	n/a	Long	1200	Full
Drain	n/a	n/a	n/a	n/a	n/a	n/a	n/a	n/a	Full

NOTES: (1) Program times will increase when you select higher wash temperatures. (See "Temperature Control" on page 3.)

(2) The maximum wash temperature for the Wool Wash and Hand Wash/Delicate programs is 105° F.

CAUTION! Some fabrics may not be able to withstand extremely hot temperatures. Always refer to the garment care label for recommended wash temperature.

W6461 OPERATING INSTRUCTIONS

WARNING! To reduce the risk of electric shock or injury to persons, read the "Important Safety Instructions" section on page 2 before operating this appliance.

THE CONTROL PANEL

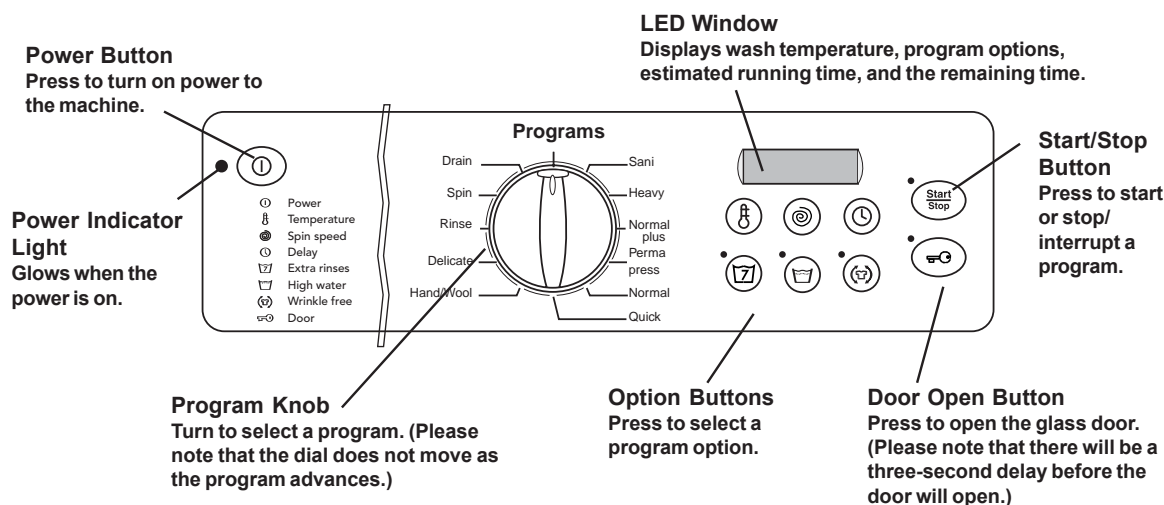

POWER BUTTON ⓘ

The Power button turns the power to the machine on and off. When the power is on, the power indicator light glows red. The power must be on before you can open the door, select program options, or start the machine.

PROGRAM KNOB

Turn this knob to the desired program. The programs are described in the table below. Please note that the knob does not move as the program advances.

Stop Position – The Stop position is where the line on the top of the dial aligns with the line on the panel.

LED WINDOW

The LED window displays the wash temperature for the selected program, the estimated running time, and the remaining time. It also displays the available options for each program. (See "Option Buttons" on the next page.)

"00" on the LED indicates no program has been selected.

"End" on the LED indicates the program is complete.

Remaining Time Indication

When you select a program, the LED displays the *estimated* program time based on the time the program ran previously. As the program progresses, the LED displays the *remaining* program time. This time will vary somewhat due to the temperature of the incoming water and the size of the load. The remaining time is recalculated before the final rinse and may be increased or decreased on the LED.

The program time and remaining time display as the hours followed by an "H" and the minutes, as illustrated:



START/STOP BUTTON

Once you've selected the program and options, press this button to start the washer. To stop the washer during a program, press and hold this button until the indicator light above it goes off. If you press this button to stop a program, the program will start again from the beginning.

DOOR OPEN BUTTON

The power must be on and you must press this button to open the door. Hold down the button until the indicator light goes off (about 3 seconds). You will hear the door lock release. Please note that the water must be drained before the door will open.

NOTE: For instructions on how to open the door manually in case of power failure, see page 24.

INTERRUPTING OR CANCELLING A PROGRAM

To interrupt a program to add an item to the wash, press and hold the Door Open button until the indicator light next to the button comes on (about 3 seconds). Any water in the machine will be pumped out before the door will open. Add the item to be washed and, if necessary, add more detergent. When you close the door, the unit will start at the point it was interrupted.

To cancel a program, press and hold the Start/Stop button until the indicator light above it goes off. When you press Start/Stop again, the program will restart from the beginning.

PROGRAMS

Your ASKO washer has several programs and options specifically designed to give you the cleanest laundry possible. The table below defines each program. The program and temperature options are defined on the next page.

Program	Pre-wash	Main Wash	Wash Action	Temp. (° F)	# Rinses	Int. Spin	Final Spin	Max Spin Speed	Load Size
Sani	Yes	Long	Normal	Cold, 85 to 205	5	2	Long	1600	Full
Heavy	No	Long	Normal	Cold, 85 to 205	5	2	Long	600	Full
Normal plus	No	Short	Normal	Cold, 85 to 205	5	2	Long	1600	Full
Perma press	No	Short	Normal	Cold, 85 to 205	3	No	Short	800	Half
Normal	No	Short	Normal	Cold, 85 to 205	3	No	Long	1600	Full
Quick	No	Short	Normal	Cold, 85 to 205	2	No	Long	1600	Half
Hand/Wool	No	Short	Gentle	Cold, 85 or 105	3	No	Short	800	Third
Delicate	No	Short	Gentle	Cold, 85 or 105	3	No	Short	800	Third
Rinse	n/a	n/a	n/a	n/a	1	n/a	Long	1600	Full
Spin	n/a	n/a	n/a	n/a	n/a	n/a	Long	1600	Full
Drain	n/a	n/a	n/a	n/a	n/a	n/a	n/a	n/a	Full

NOTE: See below for temperature options. Please note also that program times will increase when you select higher wash temperatures. (See "Temperature Control" on page 3.)

CAUTION! Some fabrics may not be able to withstand extremely hot temperatures. Always refer to the garment care label for recommended wash temperatures.

OPTION BUTTONS

The Option buttons allow you to select wash temperatures, spin speeds, delayed start, extra rinses, high-water level, and wrinkle-free. Each of these options is defined in more detail in the following paragraphs.

NOTE: The unit is programmed to retain the option selections, except for temperatures above 140° and Delayed Start.

Temperature Button

Select wash temperatures by pressing this button until the temperature you desire displays on the LED. The temperature options are 85°, 105°, 120°, 140°, 160°, 175°, and 205° F.

"C" on the LED indicates the wash temperature will be the same as that of the incoming water (cold).

The wash temperature for the Wool and Hand/Delicate wash programs can only be set for cold, 85° F, or 105° F.

NOTE: The temperature selection cannot be changed after the main wash has started.

Spin Speed Button

Select the spin speed by pressing this button until the spin speed you desire displays. The spin speeds advance in 200 rpm increments. The minimum spin speed is 400 rpm and the maximum is 1600 rpm.

The spin speed for the Perma Press, Wool and Hand/Delicate programs cannot be set higher than 800 rpm.

You can also select No Spin, which is indicated by a zero on the LED. The program will not have a spin cycle, but it will drain.

There is also a No Spin/No Drain option, which is indicated in the LED by the letters "no d." When you select this option, the program will not have a spin cycle and the unit will stop with water in the machine. You will have to set the Program knob Drain, to drain the unit before you can open the door. If you wish to spin the

load before you remove it, set the Program knob to Spin so it will spin and drain.

NOTE: The spin speed can only be altered before the main wash water is pumped out.

Delayed Start Button

This button lets you delay starting the program from 1 to 24 hours. This means you can set the washer to start at the most convenient time for you, such as an hour before you arrive home from work. This feature is also useful in areas where utility companies offer discount rates during off-peak hours.

To select delayed start, press this button until the number of hours you wish to delay starting the program displays in the LED then press Start.

If you change your mind before you press Start, you can void delay start by continuing to press the button until a zero displays in the LED. To void this selection after you have pressed Start, press and hold the Start button until the selected temperature displays on the LED.

Extra Rinses Button

Press this button to add two rinses. The indicator light next to the button stays lit when this option is selected (on). Press the button again to turn the option off. (This option cannot be altered after the main wash water is pumped out.)

High Water Button

The normal water level for an ASKO is just below the bottom of the glass door. Some users prefer to see the water level, so ASKO added this option, which increases the water level to about an inch above the bottom of the glass door. It doesn't necessarily enhance the washer's cleaning performance.

The indicator light next to the button stays lit when this option is on. To cancel this option, hold down the button until the indicator light goes off. This option cannot be

cancelled after the main wash has started.

NOTE: The Hand/ Wool and Delicate wash programs automatically have a higher water level.

Wrinkle free Button

This option is designed to reduce wrinkling of garments that are not going to be taken out of the washer right away. When you select Anti-crease, the drum will rotate once every minute at the end of the program for two hours or until you press the Door Open button.

The indicator light will stay lit when this option is on. To cancel this option, hold down the button until the indicator light goes off. This option cannot be cancelled after you have started the program.

CHANGING TEMPERATURE READOUT FROM CELSIUS TO FAHRENHEIT

You can change the temperature readout on the LED from Celsius to Fahrenheit and vice versa. To do this, follow the steps below:

1. Turn the machine off then on again. (00 should show on the display.)
2. Press the Start button five times in succession then press the Temperature button five times. (This must

be done within 15 seconds.) The LED will display a C or F, whichever is the current selection.

3. Within three seconds, press the Temperature button again to change the readout.

PROGRAMMING CHILD-SAFE START/STOP

You can program the washer not to start unless the Start button is held down for three seconds. This is to prevent children from inadvertently starting the machine. To program this function, follow the steps below:

1. Turn the machine off then on again. (00 should show on the display.)
2. Press the Start button five times in succession then press the Spin Speed button five times. (This must be done within 15 seconds.)
3. Within three seconds, press the Spin Speed button again to select Child-safe start. The LED will display "3" to indicate the Child-safe function is active. (If the child-safe start has already been activated, "0" will display after you press the Spin Speed button.)

W6461 ERROR MESSAGES

Error messages will display on the LED if faults occur while a program is in progress. The table below defines each possible error message.

To remove the message, turn the power off or change the program.

MESSAGE	ERROR
	When this symbol flashes on the LED it merely means the glass door isn't closed securely. Close the door and try again.
0000	If this message flashes on the LED, the machine has failed to spin. This could be because the load is out of balance. Turn the power off then on again. Open the door and redistribute the washing. Run the Spin program again.
F1	This indicates an overflow has occurred. Call a service technician.
F2	This indicates a problem with the motor. Call a service technician.
F3	This indicates a problem with the drain pump. Refer to the Troubleshooting chapter for possible solutions.
F4	This indicates a problem with the water inlet. Refer to the Troubleshooting chapter for possible solutions.
F5	This indicates a problem with the thermistor. Call a service technician.
F6	This indicates a temperature stop fault. Call a service technician.
F8	This indicates a door opening fault. Call a service technician.

CARE AND MAINTENANCE INSTRUCTIONS

CLEANING THE DETERGENT DRAWER

1. Pull the drawer out as far as it goes then lift it up and pull it out completely, as illustrated.

2. Clean the drawer with a soft brush under warm running water. *Do not put the drawer into a dishwasher.*

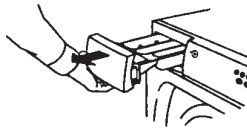

3. Replace the drawer by tilting it into position.

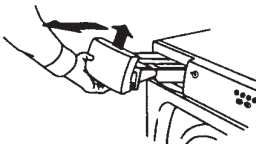

CLEANING THE PIN TRAP

Your washing machine has a pin trap designed to trap pins, hairpins, coins and similar items. This trap should be cleaned occasionally. To do this, follow the steps below:

1. Make sure as much water as possible is drained out of the tub then turn off the power to the machine.

2. Using the flat edge of the liquid detergent partition piece, a flathead screwdriver or similar item, gently pry open the drain pump cover, as shown.

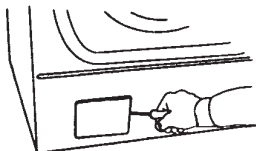

3. There is always a small amount of water in the drain pump area. Before you open the drain cover, place a shallow container, such as a pie pan, on the floor below the drain to catch the water.

4. Pull the small black drain hose loose from its position on the door cover and let the water drain into the pan.

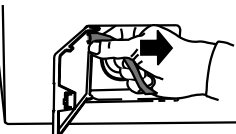

5. Unscrew the pin trap cover and lift it out.

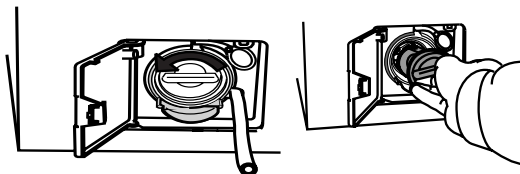

6. You can now clean out any grit or small objects. You should also clean the pump rotor at the back of the pump housing.

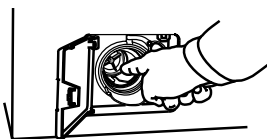

7. Replace the drain cover and reconnect the drain hose securely to its position on the door.

CLEANING THE CONTROL PANEL

To clean the control panel, use only a warm, damp cloth. To prevent penetration of water into the door lock and electrical components, **never spray water or cleaning solvents on the control panel**. Also, never use abrasive cleaners or scouring pads on the outer surfaces because they will scratch the finish and could remove the writing on the control panel. Some paper towels may also scratch the finish.

WARNING!

Never spray clean the control panel. You could damage the electrical components. Also, never use abrasive cleaners, scouring pads or paper towels on the outer surfaces because they will scratch the finish and they could remove the writing on the control panel.

REMOVING AN OBJECT FROM BETWEEN THE DRUM AND OUTER CONTAINER

Occasionally, a small item may fall between the drum and the outer container. Such items should be removed because they could corrode and cause rust stains on the laundry. To remove the item, follow the instructions below:

1. Insert a flathead screwdriver in the center hole in the paddle and carefully push it to the left.

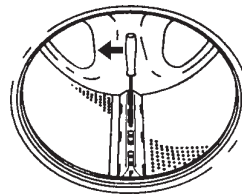

2. Grip the paddle with your other hand and pull it toward you.

3. Lift up the paddle and remove the object.

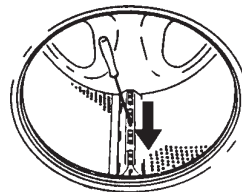

4. Replace the paddle in its fixing hole with the F-mark toward you. Check that the paddle clips are properly located in the slots and slide the paddle toward the back as far as it will go.

REMOVING HARD WATER STAINS FROM THE DRUM

If you live in an area with hard water, the washer drum may become coated with a grey-white deposit. To remove it, pour about an ounce of citric acid in the drum and run a Normal wash program at 205° F.

COMMON LAUNDRY PROBLEMS

Most items can be safely washed in an ASKO washing machine. We recommend that you follow the care label instructions as closely as possible for the best cleaning results. Should problems occur, some possible causes and suggested solutions are listed below.

NOTE: ASKO has no control over what is put in our appliances once installed in a customer's home. **You are solely responsible for what you wash in your ASKO washing machine.**

Problem	Possible Cause	Suggested Solution
Graying	<p>Not using proper amount of detergent</p> <p>Water not hot enough</p> <p>Improperly prewashed or presoaked</p> <p>Washer overload</p> <p>Soap used in hard water areas</p>	<p>You may need to use slightly more detergent if clothes are heavily soiled, have oily stains, or if your water is very hard. You may need less detergent if you have soft water or if you notice detergent residue in your clothes.</p> <p>Select a hotter temperature setting for each type of load.</p> <p>Be sure to add a prewash and/or presoak for heavily soiled or oily items.</p> <p>Once wet, the clothes must have room to tumble freely, especially synthetics and permanent press.</p> <p>Be sure you use a laundry detergent, not a "soap." Soap reacts with the minerals in hard water to form a soap curd, which can be deposited on clothes.</p>
Yellowing	<p>Not enough detergent</p> <p>Water not hot enough</p> <p>Iron or manganese in water</p>	<p>Add slightly more detergent.</p> <p>Use the hottest recommended temperature for each type of load.</p> <p>If possible, install a water filter. A small amount of Calgon or other type of water conditioner added once a week is advisable in hard water areas.</p>
Excessive wrinkling	<p>Machine too full</p> <p>Water too hot</p>	<p>Permanent press items should be washed in half-loads to prevent wrinkling. If possible, use a slower spin speed.</p> <p>Use lower wash temperature settings.</p>
Shrinkage	<p>Improper washing or drying</p>	<p>Follow garment care label instructions carefully (see page 7). Some fabrics will shrink no matter how they are washed. Some may be machine washed but not machine dried.</p>
Knit shrinkage	<p>Overheating</p> <p>Delayed or gradual shrinkage</p> <p>Poor construction</p>	<p>Knits tend to shrink more than woven fabrics. If a knit has been heat-shaped, wash in cool or warm water. Dry with the low setting.</p> <p>This can occur when special stabilizing finishes are reduced from wear or repeated washings. Garment may sometimes be reshaped by pressing after washing and drying.</p> <p>Shrinkage can occur if the knit fabric was not stretched properly by the manufacturer. Press back into shape each time garment is washed and dried.</p>
Stains	<p>Incorrect water temperature</p> <p>Old stains</p>	<p>Protein stains, such as milk, egg, blood and soy formula should be removed in cold water. Oily stains should be washed in the hottest water recommended for each fabric type.</p> <p>The longer a stain remains on a fabric, the harder it is to remove. Treat stains promptly. Do not set stains by machine drying or ironing fabrics until stains are completely removed.</p>
Lint or residue left on clothes	<p>Improper sorting of clothes</p> <p>Non-phosphate detergent</p> <p>Fabric softener used improperly</p> <p>Pilling</p>	<p>Separate clothes that shed lint (chenille and terrycloth) from clothes that attract lint (synthetics, corduroy, velveteen).</p> <p>Non-phosphate detergents can combine with minerals in hard water and form a residue which can appear to be lint. Use a low phosphate detergent. If possible, install a water softener.</p> <p>Read labels. Most softeners should only be used in the final rinse. Add softener to the softener compartment. If added to the wash cycle, softeners can have a reaction with detergents, producing a white residue.</p> <p>Pilling, which can look like lint, is produced by normal wear on cotton/polyester blend fabrics. To reduce pilling, wash these fabrics inside out. For the best results, wash in the delicate cycle.</p>

COMMON LAUNDRY PROBLEMS (CONTINUED)

Problem	Possible Cause	Suggested Solution
Fading and discoloring	Improper sorting	Dark clothes, especially cottons, can bleed excess dyes into wash water. White or light-colored clothes can absorb the dye and discolor. Separate light items from dark items.
	Crayons or pens in pockets	Always empty all pockets before washing.
	Water too hot	Cool or cold water is best for retaining dark or bright colors.
Rips, snags, excess wear	Sharp objects in pockets	Empty all pockets and turn inside out before laundering.
	Hooks, snaps, zippers, buckles	Fasten all hooks, snaps, and zippers before laundering to avoid snags. Remove sharp buckles. Turn knits inside out.
	Harsh chemicals	Before washing, rinse harsh chemicals (such as battery acid, hair care chemicals, cleaning solutions, etc.) from towels and other articles to avoid holes in fabrics. Do not allow these unrinsed items to contact other fabrics.
	Existing rips and tears	Mend all garments before laundering to prevent enlarging of rips.
	Permanent press items	These items may fray at edges from normal wear, not the washer. Wash only in half loads and don't wash in the same load with heavy items, such as towels or jeans.

TROUBLESHOOTING

If you should experience a problem with your washer, you should review the following list of frequently encountered situations or go to our website at www.askousa.com. It could save you the cost and inconvenience of a service call.

Even though the product is under warranty, if the problem is not caused by defective workmanship or materials, you will be charged for a service call. Refer to page 25 to determine what is and is not covered under your warranty. If you're still not sure, contact the AM Advisory Center before you call a service technician.

EMERGENCY DRAIN HOSE

Should you ever need to drain the water from the unit in the event of a power outage, use the drain hose next to the pin trap, as illustrated below.

- Using the flat edge of the liquid detergent partition piece, a flat-head screwdriver or similar item, gently pry open the drain pump cover, as illustrated.

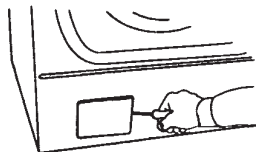

- Before you proceed, place a shallow container on the floor near the drain to catch the water.

- Pull the small black drain hose loose from its position on the door cover and let the water drain into the container.

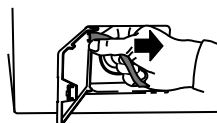

- When the machine is empty, reconnect the hose securely to its position on the door before you close the drain pump cover.

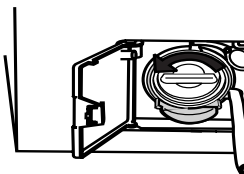

BEFORE YOU CALL

Before calling for service or contacting ASKO regarding a warranty issue, make a note of the model name, type number and serial number. The model is on the front of the detergent drawer. The type plate with the type name and serial numbers is located above the glass door. (See illustration below.)

Model Name
(e.g., W6021)

Type plate
(see below)

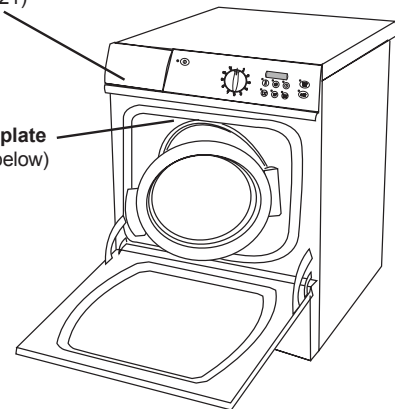

Type Name

Type: WMxx

xx.xxxxxxxxxMxxxxxxxxW

000000000000

**12-digit
Serial
Number**

TROUBLESHOOTING (CONTINUED)

The door won't open.

- ◆ Make sure the power to the unit is on. If the power is on and the indicator lamp is not lit, there is no power supply. Check that the machine is properly plugged into the electrical outlet. If it is, the fuses may be blown. Call a service technician.
- ◆ Make sure all the water has drained out.
- ◆ If there is no water in the machine and the door won't open in the normal manner, you should be able to open it manually using the emergency door handle, as follows:

1. Make sure the tub is as empty as possible and the power is turned off.



2. Using the flat edge of the liquid detergent partition piece, a flathead screwdriver or similar item, gently pry open the drain pump cover.



3. Using a T20 or flathead screwdriver, unscrew the red plastic looped handle.

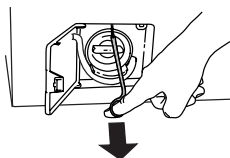

4. Pull the handle toward you. The door should open.

The machine won't start.

- ◆ Check that the glass door is closed securely.
- ◆ Make sure the power switch is turned on.
- ◆ If the power switch is on and the indicator lamp is not lit, there is no power supply. Make sure the machine is properly plugged into the electrical outlet.
- ◆ Check the house breaker switch/fuses.

The machine doesn't fill.

- ◆ Make sure the tap to the water supply line is open.
- ◆ Turn off the water supply then disconnect the inlet hose and check to see if the strainer in the inlet connection is blocked.

The machine will not spin.

- ◆ Make sure the pin trap or outlet hose isn't blocked. Clean if necessary. (See page 21.)
- ◆ Make sure the No Spin option is turned off.
- ◆ If a load is out of balance, the washer will rotate a few seconds to redistribute the load then attempt to spin again. It will do this up to ten times at a high spin speed (1000 rpm or higher). If it still isn't balanced, it will advance the timer with no spin.

Extreme vibration during spin cycle.

- ◆ Make sure the packaging and shipping supports were removed properly. (See page 4.)
- ◆ Check that the machine is level.
- ◆ Adjust machine feet and tighten locknuts. (See page 4.)

Oversudsing.

- ◆ Too much detergent could cause suds to backup through the detergent compartment and run down the front of the washer onto the floor. The suds will condensate into water and form a small puddle on the floor. (See page 8 for detergent recommendations.)

Washer stops during cycle.

- ◆ It is normal for the machine to pause occasionally during operation, especially between cycles and during the delicate wash program.
- ◆ Make sure the No Spin option isn't turned on.
- ◆ If the power switch is on and the indicator lamp is not lit, there is no power supply. Make sure the machine is properly plugged into the electrical outlet.
- ◆ Check the house breaker switch/fuses.

Foam in the final rinse water.

- ◆ Make sure nothing is blocking the outlet hose.
- ◆ Check for kinks in the outlet hose.
- ◆ Make sure the pin trap isn't blocked. (See page 21.)
- ◆ Make sure that no part of the hose (including any joints) is less than 3/4" (19 mm) in diameter.

Water left in the machine after final spin.

- ◆ Make sure the No Spin option isn't turned on.
- ◆ Make sure the pin trap isn't clogged. (See page 21.)
- ◆ Make sure the outlet hose isn't clogged.
- ◆ Check for kinks in the outlet hose.
- ◆ Make sure that no part of the outlet hose (including any joints) is less than 3/4" (19 mm) in diameter.

Water leaks.

- ◆ All hoses should be inspected at least once a year. If they show signs of cracking, they should be replaced.
- ◆ Check to see if hose connections at faucets are tight.
- ◆ Make sure the end of the outlet hose is securely inserted into the drain receptacle.
- ◆ Make sure nothing is caught between the Smart Seal and the tank, such as apron strings, small handkerchiefs, socks, etc.

PRODUCT WARRANTY

MODELS W6021, W6461

Be sure to complete the Warranty Registration Card you received with your appliance and mail it to AM Appliance Group to validate your appliance warranty.

Cosmetic damage must be reported to your dealer within five days from the date of purchase. After unpacking the washer, thoroughly check the unit for cosmetic damage.

FOR RESIDENTIAL INSTALLATIONS ONLY

LENGTH OF WARRANTY	AM APPLIANCE GROUP WILL PAY FOR:
Three-Year Full From date of purchase.	ASKO replacement parts and/or repair labor to correct defect in materials or workmanship. Service must be provided by an authorized ASKO service agent.
Fourth & Fifth Year Limited Three year full plus fourth and fifth year limited from date of purchase.	ASKO replacement parts (labor cost not included) for any defective solid-state controls, timers, motors, or pumps. Service must be provided by an authorized ASKO service agent.
Lifetime	ASKO replacement parts (labor cost not included) of the stainless steel tank if it fails to hold water due to a manufacturing defect, such as rusting or cracking. Service must be provided by an authorized ASKO service agent.

FOR NON-RESIDENTIAL INSTALLATIONS

Six-Month Full Warranty From date of purchase.	ASKO replacement parts and/or repair labor to correct defect in materials or workmanship. Service must be provided by an authorized ASKO service agent.
--	---

AM APPLIANCE GROUP WILL NOT PAY FOR:

- A. Service calls to:
 - 1. Correct the installation of the appliance.
 - 2. Repair damage due to shipment, delivery, installation, misuse or abuse.
 - 3. Instruct how to use the appliance.
 - 4. Replace house fuses or correct house wiring.
 - 5. Correct house plumbing, including drainage problems related to improper installation.
 - 6. Clean or service air device in drain line.
- B. Repair and/or replacement parts for failure of product if appliance is used for other than home/residential use.
- C. Damage resulting from accident, fire, floods, acts of God, alteration, misuse, abuse, improper installation, or installation not in accordance with local electrical or plumbing codes.
- D. Any shipping costs for parts during the limited warranty period.
- E. Replacement parts or repair labor costs for units operated outside the continental United States.
- F. Pickup and delivery. ASKO washers are designed to be repaired in the home.

IN NO EVENT SHALL AM APPLIANCE GROUP BE RESPONSIBLE FOR ANY INCIDENTAL OR CONSEQUENTIAL DAMAGES.

Some states will not allow the exclusion or limitation of incidental or consequential damages, so this exclusion or limitation may not apply to you. This warranty gives you specific legal rights and you may also have other rights which vary from state to state.

For warranty service, contact the dealer from whom you purchased the unit or an authorized ASKO service agent. Service will be provided during normal business hours. Should you have a service problem that cannot be resolved locally, contact AM Appliance Group at the numbers listed below. Before calling for service or contacting AM Appliance Group regarding a warranty issue, make a note of the model, type name, and serial number (see page 23).

Write to us at:
AM Appliance Group
P. O. Box 851805
Richardson, Texas 75085-1805
www.askousa.com

Or call our
ASKO Advisory Center a
Division of AM Appliance Group at
800-898-1879 or
972-238-0794

INDEX

Symbols

7 button	10		
800 button	10		
A			
Allergies	6		
Anti-crease button (W6461)	14		
Automatic water level control	3		
B			
Bleach	8		
Built-in installation	5		
C			
Cancelling a program (see "interrupting a program")			
Care and cleaning	15		
Care label instructions	7		
Celsius, changing readout			
W6461	14		
Child safety features	2		
Child-safety catch	8		
Child-safe start			
W6461	14		
Control panel			
cleaning	15		
W6021	10		
W6461	12		
Cottons	6, 9		
D			
Delayed Start button (W6461)	13		
Delicate fabrics	6		
Detergent	8, 9		
Detergent drawer	8		
cleaning	15		
Discoloring	17		
Door Open button	10, 12, 16		
Drain hose, emergency	17		
Drain outlet connection	5		
Drum	15		
Drum paddles, removing	15		
Dyeing fabric	9		
E			
Electrical connections	5		
Emergency door handle	18		
Emergency drain hose	17		
Enzyme step	3		
Error messages			
W6461	14		
F			
Fabric softener	9		
Fabrics			
dyeing	9		
recommended wash temps	9		
Fading and discoloring	17		
Fahrenheit, changing display window			
W6461	14		
Fluorescent colored fabrics	6		
Foam in final rinse	18		
Free-standing installation	5		
G			
Garment care label instructions	7		
Glass door			
emergency opening	18		
Graying	16		
Grounding instructions	5		
H			
Hard water	9		
Hard water stains, removing	15		
Hazardous materials	2		
HE detergents	8		
High water option			
W6461	14		
I			
Installation instructions	4, 5		
Interrupting a program			
W6021	10		
W6461	12		
K			
Knit shrinkage	16		
L			
Laundry detergents	8		
Laundry problems	16, 17		
Laundry tips	6		
LED window (W6461)	12		
Leveling the machine	4		
Linens	6		
Lint (Pin) trap	16		
Lint left on clothes	17		
Liquid detergent	8		
Load sizes, recommended	6, 9		
Low-sudsing detergents	8		
M			
N			
No spin/no drain option			
W6021	10		
W6461	13		
Nylon	9		
O			
Operating instructions			
W6021	10		
W6461	12		
Options			
W6021	10		
W6461	13		
Oversudsing	18		
P			
Paddles, removing	15		
Permanent press items	6		
Pin trap, cleaning	15		
Poison hotline	2		
Polyester blends	9		
Powder detergents	8		
Power button			
W6021	10		
W6441	12		
Preparing the laundry	6		
Problems (e.g., stains, etc.)	16, 17		
Program knob			
W6021	10		
W6461	12		
Programming			
Celsius or Fahrenheit (W6461)	14		
child-safe start (W6461)	14		
Language	19		
Menus	18		
Programs	10, 13		
W6021	10		
W6461	13		

INDEX (continued)

R

Rayon and acetate	9
Recommended detergents	8
Recommended wash temps	9
Remaining time indication	
W6021	10
W6461	12
Rinse cycles	3
Rips	17

S

Safety instructions	2
Sensitive skin, advice	6
Sensor Level Control	3
Serial number location	17
Service	19
Shipping supports	4
Shrinkage	16
Silk	9
Snags	17
Solutions to problems	17
Sorting the laundry	6
Specifications	4
Spin options	3, 9
Spin Speed button (W6461)	13
Spray cleaner warning	15
Stacked installation	5
Stains	22
Start/Stop button	10, 12
Super Rinse button	
W6021	10
W6461	13
Super Rinse	3

T

Temperature	
changing readout (W6461)	14
control	3
Temperature button (W6461)	13
Troubleshooting	17
Type plate location on unit	17

V

Vibration, extreme	18
--------------------	----

W

Warranty information	19
Wash programs	9
W6021	10
W6461	13
Wash temperature control	3
Wash temperatures	9
Washer features	3
Washing special items	16,17
Water	
hardness	9
leak	18
level control	3
supply connection	4
Wear	17
Wool and wool blends	9
Wrinkling	17

Y

Yellowing	16
-----------	----

