

This Owner's Manual is provided and hosted by [Appliance Factory Parts](#).

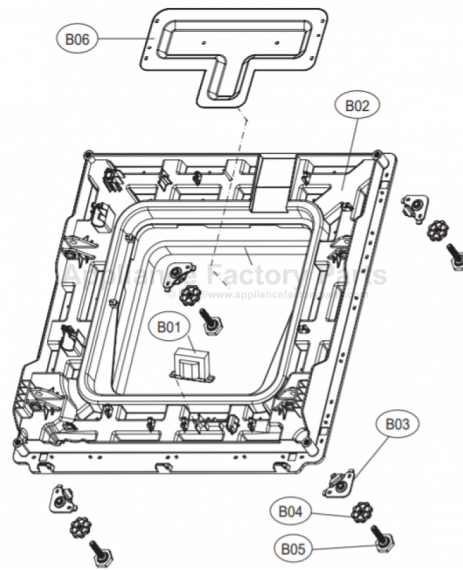

ASKO WL6511XXLPP Owner's Manual

[Shop genuine replacement parts for ASKO
WL6511XXLPP](#)



[Find Your ASKO Washer Parts - Select From 53 Models](#)

----- Manual continues below part list -----

Available Replacement Parts for ASKO WL6511XXLPP

36189L5600	DRAIN PUMP XXL WM
3619046410	SWITCH-DOOR LOCK XXL WM

Operating Instructions

Washing Machine

Save these instructions for future reference

Dear Customer,

Thank you for choosing this quality product from ASKO. We hope it will meet all of your expectations and fulfill your needs for many years to come. The Scandinavian design is a combination of clean lines, everyday functionality and high quality. These are the hallmarks for all of our products and this is why they are so highly appreciated all over the world.

To get the most out of your new ASKO product, we recommend that you read the installation and operating instructions before using the machine.

Asko WL6511 XXLW

 **ASKO**

1

Customer Care Center
1-800-898-1879
www.askousa.com

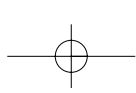
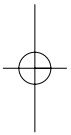
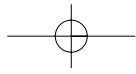

Contents

Before using your machine for the first time	3	Stain removal rules	22
Removing shipping bolts	3	Stain removal guide	22
Packing material	3	Troubleshooting	23
Checking water hardness	3	The washer will not operate at all	23
Important safety instructions	4	Water is not supplied	23
Grounding instructions	4	The washer will not drain	23
Installation	5	The washer will not spin	23
Transport/Winter storage	5	Spinning is insufficient	23
Recycling	5	Vibrating and too noisy	23
Child safety	6	Technical information	24
Description of the washing Machine	7	Technical data	24
Detergent compartment	7	Installation instructions	25
Front panel	8	Removing shipping bolts	25
Advice and tips before washing	9	Location of your washer	25
Sorting your laundry	9	Level adjustment	26
Clothing	9	Connecting water supply hoses	26
Laundry labels	9	Drain system	27
Laundry label symbols	9	Electrical connection	27
Laundry care symbols	10	Grounding instructions	27
Colored cotton	11	Positioning the washer	28
Delicates	11	Service and guarantee	29
Wool and silk	11	Quick guide	31
Artificial fibers and synthetic fibers	11		
Save time and energy	11		
Economy and efficiency	11		
Detergents	11		
Liquid detergents	12		
Recommended powder detergents	13		
Amount of detergent to use	13		
Detergent Amounts Based on Water Hardness	14		
Operating instructions	15		
Selecting Settings	18		
Selecting Options	19		
Care and maintenance			
Instructions	20		
Cleaning your washer	20		
Winter storage or moving care	20		
Non-use or vacation care	20		
Cleaning the water inlet filter	20		
Cleaning the drain filter	21		
Cleaning the detergent compartment	21		
Cleaning the lifter filter	21		
Removing Stains	22		

Before using your machine for the first time

Removing shipping bolts

Has the shipping bolt been removed?
If not, see the "Installation instructions" chapter.

Packing material

Please sort waste materials in accordance
with local guidelines.

Checking water hardness

The quantity of detergent needed depends,
among other things, on water hardness.
Phone your local water company to check the
water hardness in your area.

Important safety instructions

To reduce the risk of fire, electric shock, or injury to persons when using your appliance, follow basic precautions, including the following:

- Read all instructions before using the appliance.
- Do not run appliance while you are out of the home.
- Do not wash or dry articles that have been previously cleaned in, washed in, soaked in, or spotted with gasoline, dry-cleaning solvents, cooking oils, or other flammable or explosive substances because they give off vapors that could ignite or explode.
- Do not allow children to play on or in the appliance. Close supervision of children is necessary when the appliance is used near children.
- Before the appliance is removed from service or discarded, remove the door to the washing compartment.
- Do not reach into the appliance if the drum is moving.
- Do not install or store this appliance where it will be exposed to the weather.
- Do not tamper with controls.
- Do not repair or replace any part of the appliance or attempt any servicing unless specifically recommended in the user repair instructions or in published user repair instructions that you understand and have the skills to carry out.
- Do not add gasoline, dry-cleaning solvents, or other flammable or explosive substances to the wash water. These substances give off vapors that could ignite or explode.
- Under certain conditions, hydrogen gas may be produced in a hot water system that has not been used for 2 weeks or more. **HYDROGEN GAS IS EXPLOSIVE.** If the hot water system has not been used for such a period, before using a washing machine or combination washer-dryer, turn on all water faucets and let the water flow

from each for several minutes. This will release any accumulated hydrogen gas. As the gas is flammable, do not smoke or use an open flame during this time.

Warning!



This appliance must be properly grounded. This manual does not cover every possible condition and situation that may occur. Use common sense and caution when installing, operating, and maintaining any appliance.

Grounding instructions

A) Grounding instructions for a grounded, cord-connected appliance:

In the event of malfunction or breakdown, grounding will reduce the risk of electric shock

by providing a path of least resistance for electric current. This appliance is equipped with a cord having an equipment-grounding conductor and a grounding plug. The plug must be plugged into an appropriate outlet that is properly installed and grounded in accordance with all local codes and ordinances.

Warning!



Improper connection of the equipment grounding conductor can result in a risk of electric shock. Check with a qualified electrician or service representative or personnel if you are in doubt as to whether the appliance is properly grounded. Do not modify the plug provided with the appliance. If it will not fit the outlet, have a proper outlet installed by a qualified electrician.

Important safety instructions

B) Grounding instructions for a permanently connected appliance:

This appliance must be connected to a grounded metal, permanent wiring system, or an equipment-grounding terminal or lead on the appliance.

Note

This manual does not cover every possible condition and situation that may occur. Use common sense and caution when installing, operating, and maintaining any appliance.

Installation

See the "Installation" chapter.

Transport/Winter storage

If the machine is to be transported or stored in unheated premises where the temperature can fall below freezing, do as follows:

- Empty the filter and drain pump (see the "Care and Cleaning" chapter).
- Shut off the water to the washing machine, loosen the supply hose to the intake valve, and let the water run out from the valve and hose.

Recycling

When the machine has reached the end of its service life and is to be disposed of, it should immediately be made unusable by removing the door to the washing compartment. Contact your local authorities for information about where your machine should be disposed of and recycled in the proper way. The machine is manufactured and labeled for recycling.

Child safety

- Laundry detergents are corrosive, so always keep them out of reach of children.
- Should a child swallow detergent, give plenty to drink immediately, i.e., one or two glasses of milk or water. Do not try to induce vomiting. Seek medical advice immediately: The National Poison center phone number is 1-800-222-1222.
- Always close the door and start the appliance as soon as you put in the detergent.
- Always turn the power off to the machine when it is not in use.
- Always keep small children away from the machine when it is open. There may be some detergent residue left inside the machine.
- If laundry detergent gets in someone's eyes, rinse them with plenty of water for at least 15 minutes.

Description of the washing machine

1. Detergent compartment
2. Main power button
3. Program panel
4. Washer door
5. Drain pump cover
6. Drain pump (behind drain pump cover)
7. Adjustable leg

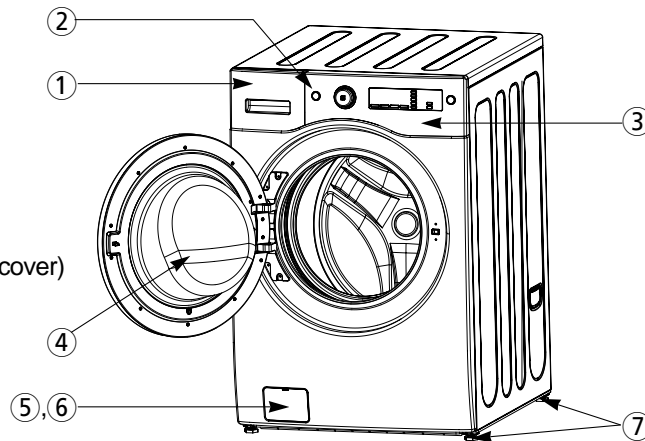

Accessories

Drain hose	Inlet hose	Wrench	Owner's Manual	Cap holder (4EA)	Pedestal Purchased Separately
					 * Design of pedestals is subject to change without manufacturers notice.

Detergent compartment

1. Detergent compartment - main-wash
2. Detergent compartment – pre-wash
3. Fabric softener compartment
4. Liquid bleach compartment

Note!

- Place liquid detergent cup in the detergent compartment if you use liquid detergent.



- Powdered detergent will not dispense with the liquid detergent cup.
For powdered detergent, remove the liquid detergent cup.

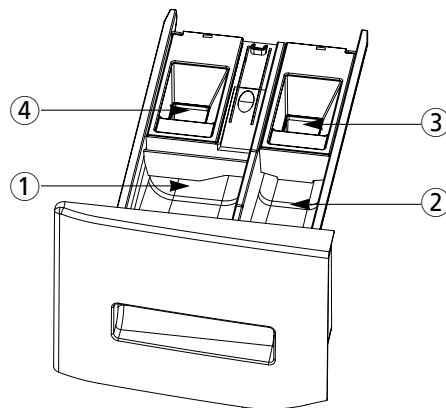

Front panel

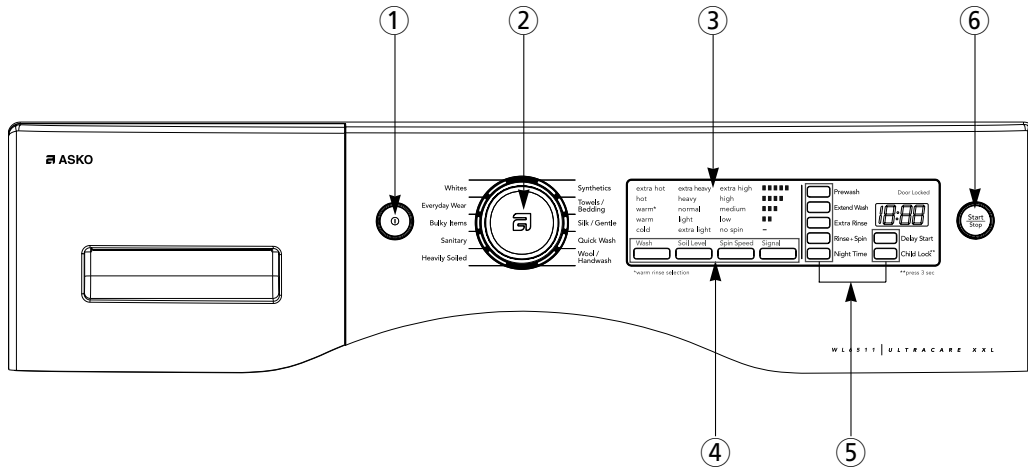

- 1. Main power button
- 2. Program selector
- 3. Display window

- 4. Setting buttons
- 5. Option buttons
- 6. Start/Stop button

Advice and tips before washing

Here are some tips that may help you before washing.

Sorting your laundry

Sort items according to:

- how soiled they are
- color
- material

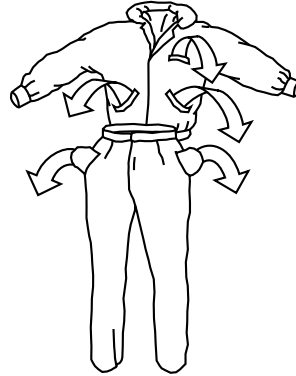





Clothing

- Close zippers so that they don't harm fabrics.
- New colored items may contain excess dye and should therefore be washed separately the first few times.
- Turn delicate items inside out. This reduces the risk of burling and fading.
- Empty pockets and wash them inside out if possible!

Laundry labels

Look at the item's laundry label. The table below shows suitable wash programs for different materials and wash loads. Using modern washing machines and detergents, such as compact detergents, you can usually wash at lower temperatures. It is a good idea to use trial and error to find out what produces the best results.







Laundry label symbols

Laundry labels	Material	Program	Load
	Cotton, linen, white, and light-colored items.	Sanitary Extra Hot	Full load
	Cotton, linen. Dark-colored items.	Everyday Wear Warm	1/2 load
	Polyester, cotton/polyester, nylon. White items.	Everyday Wear Warm	1/2 load
	Rayon, acetate, acrylic. Non-colorfast items.	Everyday Wear Warm	1/2 load
	Polyester, cotton/polyester, nylon. Colored items.	Everyday Wear Warm	1/2 load
	Silk and very delicate items	Silk/Gentle Cold	1/2 load
	Items labeled with the IWS or Super-wash mark	Wool/Handwash Cold	1/3 load







Advice and tips before washing

Laundry care symbols



Wash cycle

-  Normal wash cycle
-  Permanent Press or Wrinkle Resistant setting
-  Gentle/Delicate setting
-  Hand wash only
-  Do not wash
-  Do not wring. Hang dry, drip dry, or dry flat

Wash water temperature

-  Maximum water temp
200° F/95° C
-  Maximum water temp
160° F/70° C
-  Maximum water temp
140° F/60° C
-  Maximum water temp
120° F/50° C
-  Maximum water temp
105° F/40° C
-  Maximum water temp
85° F/30° C





Bleach instructions

-  Any bleach when needed
-  Only non-chlorine bleach
-  Do not bleach





Dry clean symbol

-  Dry clean only





Tumble dry cycle

-  Machine dry
-  Normal setting
-  Permanent Press or Wrinkle Resistant setting
-  Gentle or Delicate setting
-  Do not tumble dry







Tumble dry heat setting

-  Any heat
-  High heat
-  Medium heat
-  Low heat
-  No heat/Air fluff

Special drying instructions

-  Line dry or hang to dry
-  Drip dry (do not spin or wring)
-  Dry flat
-  Dry in shade

Ironing instructions

-  Ironing is necessary
-  High temperature setting
-  Medium temperature setting
-  Low temperature setting
-  Do not iron or press with heat
-  Iron without steam

Advice and tips before washing

Colored cotton

Colored cotton items labeled 140 °F (60 °C) should be washed on HOT, at first time in order to remove any excess dye. If you do not do so, there is a risk that the color will run. Use detergent without bleach in order to preserve the color of the fabric.

Delicates

Unbleached linen

Unbleached linen fabrics should be washed at 140 °F (60 °C), using detergent containing no bleach or optical whiteners. Heavily-soiled linen can occasionally be washed at higher temperatures, but not too often as the heat can destroy the linens sheen and strength.

Wool and silk

These fabrics are sometimes labeled as machine washable and sometimes as hand wash. The machines Wool/hand program is just as gentle as washing by hand. Wool is especially sensitive to processes such as washing. If you do not wish to spin dry, you can squeeze out the water using terrycloth towels. In this case select No spin. To find out how to select this setting, see the Operating instructions. However, most items can withstand a short spin. Select short spin by selecting a spin speed below medium.

Artificial fibers and synthetic fibers

These materials require plenty of room to prevent them from getting wrinkled. Only fill half the drum when washing artificial or synthetic fibers. Choose a short spin by selecting a spin speed of medium.

Note!

Viscose and acetates are fragile when wet.

Save time and energy

Use the White program to save time and energy. This program has a shorter main wash than a Stain - Color wash, but it is often long enough for normally soiled laundry.

Economy and efficiency

You can save a lot of energy by not using higher temperature programs than necessary.

- Select Quick wash if you just need to freshen up shirts or sports clothes, for example. This will save both water and energy.
- If you select a fast spin speed, this reduces energy consumption when drying in a tumble dryer or drying cabinet.
- Try to use fully loaded machine whenever possible.
- Avoid washing with pre-wash. Modern machines and detergents clean without pre-wash. Only garments soiled with protein stains such as grape juice or grass are likely to need a pre-wash.

Detergents

Eco-labeled detergents are less harmful to the environment.

Detergent overdosing does not give better washing results; it merely causes a greater impact on the environment.

Try to use less detergent, and increase only if you are not satisfied with the results.

Note!

Due to environmental concerns, we discourage the use of strong chemicals. When using agents for bleaching or stain removal, there is a risk of rust (corrosion) and discoloration of the machine.

Advice and tips before washing

Detergents

Note!

Due to environmental concerns, we discourage the use of chlorine bleach in your Asko washing machine. The tumbling wash action, temperature control options, extended wash times and proper amount of detergent are sufficient to remove most stains.

Laundry detergents are available in low-, normal- and high-sudsing formulas. A detergent's ability to clean is not relative to the amount of suds it produces. Excess suds in a front-loading washer actually interfere with the cleaning because they cushion the tumbling action. Also, high-sudsing detergents are more difficult to completely rinse out.

The use of anything other than a low-sudsing detergent can cause severe oversudsing, which could cause suds to backup through the detergent compartment and run down the front of the washer onto the floor. If oversudsing occurs, run the wash through one or more rinse programs until all items are thoroughly rinsed. Remove the laundry then run the washer through a Normal wash program to get rid of any remaining detergent.

Due to environmental concerns, we discourage the use of chlorine bleach in your Asko washing machine.

The tumbling wash action, temperature control options, extended wash times and proper amount of detergent are sufficient to remove most stains.

Liquid detergents

We don't recommend liquid detergents

because they tend to produce more suds than powder detergents when used in water temperatures of 150 F or higher. If you should try a liquid detergent, start with a very small amount, such as 1 to 2 tablespoons. Also, liquid detergent can be used for all programs without pre-wash, so add it into the main wash compartment.

Should you prefer to use a liquid detergent, we have provided a liquid detergent cup specifically for use with liquid detergents. Insert the liquid detergent cup in the main wash compartment before you pour in the liquid detergent.

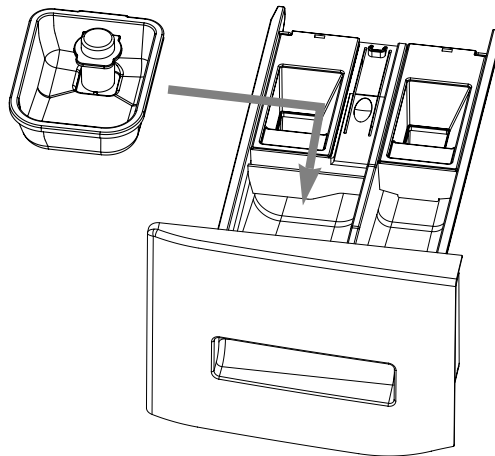

Note!

The liquid detergent cup is supplied with the machine

Advice and tips before washing

Recommended powder detergents

ASKO washers use 50% to 75% less detergent than most other washers. This is because of their low water consumption and the fact that all the wash water is repeatedly circulated through the laundry, ensuring that all the detergent is fully utilized. We recommend that you use powder detergents made specifically for front-loading washers. These are sometimes called HE (High-Efficiency) detergents. Listed below are some low-sudsing powder detergents that have been successfully tested in ASKO washers:

- Fab
- All
- Tide HE
- Amway SA8
- Fresh Start
- Wisk HE

We recommend that you do not use any powder detergent that doesn't wash completely out of the detergent drawer.

Amount of detergent to use

The amount of detergent needed varies among the different brands, but for most detergents, you need only one or two tablespoons. Using too much detergent can result in detergent residue being left in your clothes, which can cause them to appear gray or dingy. You should start with a small amount of detergent and increase it only if the cleaning results are unsatisfactory.

Additionally, you should never put detergent in the pre-wash compartment unless you are using a wash program that has a pre-wash cycle. This could cause excess foaming, which could damage the machine.

The amount of detergent needed can also depend on the hardness of the water in your area. See the "Detergent Amounts Based on Water Hardness" section on the next page for more details.

Advice and tips before washing

Detergent Amounts Based on Water Hardness

The amount of detergent needed can vary due to differences in water hardness. To determine the water hardness in your area, contact your local water utility or area water softening company. The harder the water, the more detergent you may need.

Remember, you should adjust the amount of detergent you use by small amounts until you find the correct amount.

Note that 12 grains and higher is extremely hard water and detergent alone may not be enough. You may need to use a water softener to maximize the performance of your washer. Also, in areas with extremely hard water (9+) you may need to wash at lower temperatures to prevent hard water deposits from forming in the tank and wash system.

Different brands of detergent have different amounts of phosphorous for softening water. If you have hard water and use a detergent with less than 8.7% phosphorous content, you may need to use more detergent or use a detergent with a higher phosphorous content.

Operating instructions

1 Sort your laundry.

See the "Advice and Tips" section before washing.

Note!

Always place underwire bras and similar garments that can damage the washing machine in a laundry net.

Note!

Empty pockets. Coins, nails, and the like can cause damage to the machine and fabrics. See the "Advice and Tips" section before washing.

2 Turn on the main power switch.

3 Open the washer door and load the laundry

Load the laundry. The laundry program chart shows how much laundry can be washed with each program.

4 Add detergent, liquid bleach, and fabric softener as required

Powder detergent

The detergent packaging will provide a recommendation on how much detergent to use. The machine holds 3.29cu.ft of laundry. If you only have a small amount of laundry in the machine, you can reduce the amount of detergent used. The liquid detergent box provided should only be used with liquid detergent.

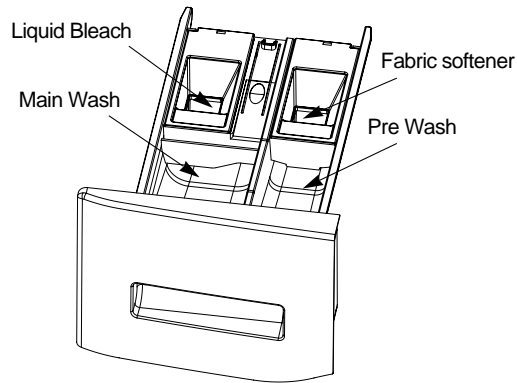

Liquid detergent

When using liquid detergent, follow the detergent manufacturer's recommendations. For liquid detergent, Place the liquid detergent cup in the detergent compartment as shown in the illustration. Pour the detergent directly into the compartment for the main wash.

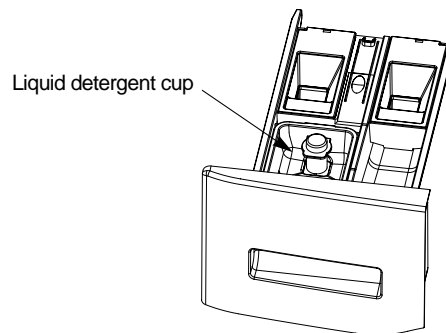

Note!

Detergent overdosing does not give better washing results; it merely causes a greater impact on the environment.

Try using less detergent, and increase only if you are not satisfied with the results.

Operating instructions

Liquid Bleach

When using liquid bleach, follow the bleach manufacturer's recommendations. The bleach will be automatically dispensed at the proper time during the wash cycle.

Note!

Do not fill above the compartment's maximum fill level. Overfilling can cause early dispensing of the bleach which could result in damaged clothes. Do not pour undiluted liquid chlorine bleach directly onto the load or into the drum. Fabric damage can occur.

Fabric softener

Pour the fabric softener into the fabric softener compartment. Follow the recommendations on the fabric softener packaging.

Note!

Do not fill above the compartment's maximum fill level. Otherwise fabric softener will be dispensed too early, which impairs the washing effect.

5 Select the program

You can select a program by turning the program selector. A red field lights up beside the selected program and the estimated program time appears on the display. Start the program by pressing the Start/Stop button or go to Options and Settings.

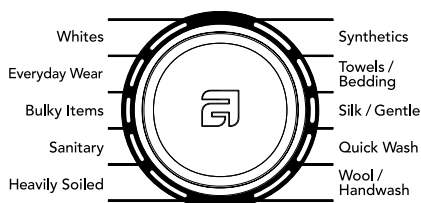

White

This selection is used for washing white cotton, linen, towel and sheets

Everyday Wear

Use this program for normally soiled work clothes, jeans, shirts.

Bulky Items

This program is used for washing blanket, curtain, etc.

Sanitary

This program is used for heavily soiled laundry, underwear, work clothes, diapers, etc.

Heavily Soiled

Use this program for heavily soiled laundry. (white cotton, linen, towel and sheets...)

Synthetics

This program is used for dress shirts/pants, wrinkle free clothing, poly/cotton blend clothing, tablecloths.

Towels/Bedding

This program is used for washing cotton, linen, towels, shirts, sheets

Silk/Gentle

Use this program for the delicate laundry, silk, Curtain, ...

Quick Wash

Lightly soiled laundry that only needs to be freshened up can be washed for a short time.

Wool/Hand wash

This program is used for clothes labeled Wool/Hand wash. The program has a short spin.

Operating instructions

Program chart

PROGRAM Sequence		Wash	Temperature	Rinse	Spin	Soil	Delay Start	Pre Wash	Extra Wash	Extra Rinse	Rinse +Spin	Night Time	Duration Time(min.)
HEAVILY SOILED	Default	Pre Wash + Main wash	Warm*	3	High	Normal		●					104
	Selectable		Cold ~ Hot	-	No Spin ~ Ex. High	Extra. Light ~ Extra Heavy	●		●	●	●	●	
SANITARY	Default	Main wash	Ex. Hot	2	Medium	Normal							90
	Selectable		Warm*	-	No Spin ~ Ex. High	Extra. Light ~ Extra Heavy	●	●	●	●	●	●	
BULKY ITEMS	Default	Main wash	Warm	2	Medium	Normal							74
	Selectable	x	Cold ~ Warm*	-	No Spin ~ High	Extra. Light ~ Extra Heavy	●	●	●	●	●	●	
EVERYDAY WEAR	Default	Main wash	Warm	2	Medium	Normal							65
	Selectable		Cold ~ Hot	-	No Spin ~ Ex. High	Extra. Light ~ Extra Heavy	●	●	●	●	●	●	
WHITE	Default	Main wash	Warm	2	Medium	Normal							63
	Selectable		Cold ~ Hot	-	No Spin ~ Ex. High	Extra. Light ~ Extra Heavy	●	●	●	●	●	●	
SYNTHETIC	Default	Main wash	Warm	2	Low	Normal							59
	Selectable		Cold ~ Hot	-	No Spin ~ Ex. High	Extra. Light ~ Extra Heavy	●	●	●	●	●	●	
TOWEL/ BEDDING	Default	Main wash	Warm	2	Ex. High	Normal							53
	Selectable		Cold ~ Hot	-	No Spin ~ Ex. High	Extra. Light ~ Extra Heavy	●	●	●	●	●	●	
SILK/ GENTLE	Default	Main wash	Cold	1	Low	Normal							37
	Selectable	x	x	-	No Spin ~ Medium	Extra. Light ~ Extra Heavy	●	●		●	●	●	
QUICK WASH	Default	Main wash	Cold	1	Low	Light							33
	Selectable		Cold ~ Warm*	-	No Spin ~ Medium	x	●				●	●	
WOOL/ HANDWASH	Default	Main wash	Cold	1	Low	Light							30
	Selectable	x	x	-	No Spin ~ Low	x	●			●	●	●	

Selecting Options

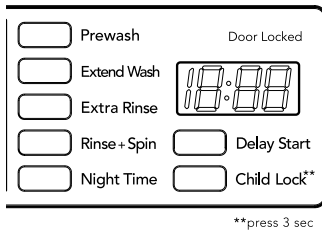

Pre-wash

Use this option for loads that need pre-treatment. Adds 16 minutes pre-wash and drain.

Extend Wash

Adds time to the wash for better stain removal.

Extra Rinse

Provides an additional rinse.

Use this option to ensure the removal of detergent or bleach residue from garments.

Rinse + Spin

Use this option to rinse and then spin.

Night Time

The NIGHTTIME cycle reduce the noise. This option has lower spin speeds possibly making dry times in the dryer longer

Delay Start

Can be used to delay the wash cycle from 1 to 12 hours.

Child Lock**

The child lock option can be used to prevent a child from pausing or cancelling a wash program. To set this option, you must first select a wash program and any desired options. Press the Start/Stop button to start the cycle. Next, press the Child lock button for 3 seconds to engage the Child lock option. Child lock will be lit up as long as the option is active. To cancel this

mode, hold the Child lock button again for 3 seconds.

Note!

The Child lock option will be cancelled when the Child lock button is held for 3 seconds, the power is turned off, or when the wash program is complete.

7 Close the door and press the Start/Stop button

Time remaining

The time remaining is shown in hours and minutes. Once a program has been selected, an estimated running time for the complete program is displayed. This may differ from time to time depending on the temperature of the water entering the machine and the size of the load. During the actual program the time counts down in minutes.

Stopping or changing a program

You can also stop a program by pressing the Start/Stop button.

To restart the machine, select a new program, add any extra detergent needed, and press the Start/Stop button.

Note!

If you select a wash program and options but do not start that program within 10 minutes, the washer will shut off automatically.

8 Once the program has finished

Once a wash program has finished, the washer will automatically turn itself off.

If you have small children or pets at home, close the washer door once you have removed the laundry.

Care and maintenance instructions

Proper care of your washer can extend its life. This section explains how to care for your washer properly and safely.

Cleaning your washer

Exterior - Wipe up detergent, bleach, and other spills with a soft, damp cloth or sponge as they occur. Do not use any solvents, as these can damage the machine.

Interior - Clean interior with 250ml (1 cup) of chlorine bleach mixed with 500ml (2 cups) of detergent. Run washer through a complete cycle.

Repeat this process if necessary.



Winter storage or moving care

Install and store your washer where it will not freeze. Because some water may stay in the hoses, freezing can damage your washer.

If you store or move your washer during freezing weather, winterize it.

To winterize washer

1. Turn off water faucet.
2. Disconnect and drain water inlet hoses.
3. Run washer on a drain and spin setting for 1 minute.
4. Unplug the power supply cord.
5. Open the drain pump cover and remove the coin trap insert. Use a shallow bowl or old towels to catch the water that drains from the unit. Replace the coin trap and close the drain pump cover.

Non-use or vacation care

Operate your washer only when you are at home.

If you are on vacation or don't use your washer for an extended period of time, you should:

- Unplug the power supply cord or turn off power to the washer.
- Turn off the water supplier to the washer. This helps avoid accidental flooding (due to a water pressure surge) while you are away.

Cleaning the water inlet filter

If your water is very hard or contains traces of lime deposit, the water inlet filter may become clogged.

1. Pull the power plug out before cleaning it.

2. Turn off the water supply to the washer and separate the inlet hose.



3. Pull the inlet filter out. Remove the dirt from the inlet filter with a brush.

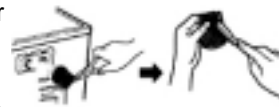

4. Put the inlet filter back. Tighten the inlet hose.



Care and maintenance instructions

Cleaning the drain filter

The drain filter is used to catch items such as threads, coins, pins, buttons, and items left in pants pockets.

The drain filter needs to be cleaned regularly otherwise drain problems could occur.

Caution : Be careful when draining if the water is hot.

1. Open the drain pump cover (1) by using a coin. Pull out the hose.

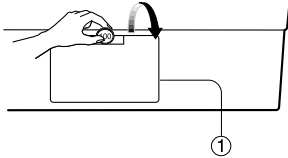

2. Unplug the hose cap (2) and drain the water into a shallow bowl or some old towels. When the water flow stops, turn the pump filter (3) counterclockwise to remove it.

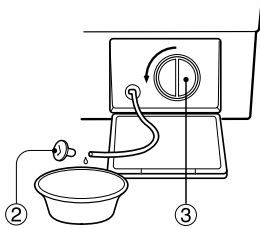

3. Remove any debris that is in the pump filter. (3). Once clean, replace the pump filter by turning it clockwise. Plug the drain hose with the hose cap and snap the hose into its holder. Close the drain pump cover.

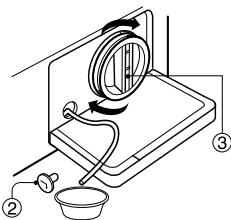

Cleaning the detergent compartment

After a while detergent and fabric softeners leave a deposit in the detergent drawer.

If you need to clean the detergent compartment:

- Press down on the catch on the detergent compartment and remove the drawer.
- Wash the drawer in a sink of warm water. The lid of the fabric softener compartment may be removed for easier cleaning.
- Detergent can also accumulate inside the detergent drawer housing and should be cleaned periodically with a brush.
- Once clean, replace the detergent drawer and run a rinse cycle without laundry in the machine.



Cleaning the lifter filter

Sediment Removing filter

1. Press the hook and push it to the arrow direction
2. Hold the front part of the filter, separate from the lifter
3. Open the filter and remove the sediment
4. First, Insert the back part of the filter to the lifter and assemble it as pressing the front part of the filter last.
5. Press the hook and reassemble it to the arrow direction

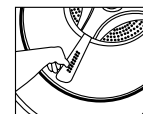
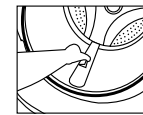
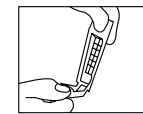
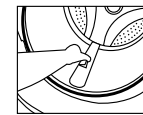
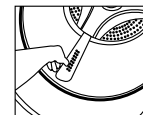

Removing Stain

Stained, heavily-soiled, or greasy items may need to be prewashed or soaked for best results.

Soaking helps remove protein-type stains like blood, milk or grass.

Prewashing helps loosen soil before washing.

Stain removal rules

- Use warm water for soaking or pre-washing stained laundry. Hot water can set stains.
- Most stains are easier to remove when they are fresh.
- Before treating any stain, find out what kind of stain it is, how old the stain is, what kind of fabric it is, and whether the fabric is colorfast. (Check the care label)
- Washing and drying can set some stains.
- Start with cold or warm water. Hot water can set some stains.
- When bleach is recommended, use a Bleach that is safe for the fabric.
- Put the stained area face down on a paper towel or white cloth. Apply the stain remover to the back of the stain. This forces the stain off fabric instead of through it.

Stain removal guide

Blood - Rinse immediately in COLD water. If stain remains, soak in cold water with an enzyme prewash.

Chewing gum - Use ice in plastic bag to harden the gum. Scrape off what you can and the sponge with commercially available stain remover.

Cocoa, Chocolate - Sponge with COLD water and soak in an enzyme prewash. If stains persist, rub in a little detergent and rinse in cold water.

Coffee - Blot up quickly and rinse out in COLD water. Rub in a little detergent and wash in the maximum temperature allowed for the fabric type.

Cream/Milk/Ice cream - Rinse in COLD water and wash normally. If stain is still apparent, sponge with commercially available stain remover.

Deodorant - Rub affected area with white vinegar and then rinse out in COLD water. Sponge with commercially available stain remover. Treat stiffened areas with enzyme pre-wash.

Egg - Soak in a COLD enzyme pre-wash, rinse and wash normally.

Fabric/Softener - Rub affected area with bar soap and wash normally.

Fruit stains - Treat as soon as possible by sponging with COLD water. Rub a little detergent on the stain and wash normally.

Grass - Sponge with white spirits. Rub in an enzyme prewash and wash as normally.

Grease and oil - Lay the affected area face down on an absorbent cloth and work from the back. Sponge with commercially available stain remover. Wash normally.

Iron or rust - Apply lemon juice and salt and place in the sun. Wash normally.

Lipstick - Sponge with commercially available stain remover and wash normally.

Mildew - Wash in WARM water and detergent.

Moisten area with lemon juice, dry in the sun and wash normally. If stain persists and the fabric allows, use a bleach.

Mud - Brush off any dry mud. Rinse in cold water. If stain persists rub in a little detergent and wash normally.

Paint-oil based - Scrape off any fresh paint and sponge with a non flammable dry cleaning fluid and wash normally.

Paint-water based - Treat while still wet, rinse in WARM water and wash normally.

Scorch marks - Dampen a cloth with hydrogen peroxide, lay it over the affected area and press with a fairly hot iron.

Troubleshooting

Most problems are easily solved if you understand the cause. If the machine shows an error code in the display, consult the fault code descriptions below for a possible cure. Once you've tried the following suggestions, turn the power to the washer off. Next, turn the machine back on and restart the wash cycle.

If you are unable to resolve the issue, call our Customer Care Center at the number on the bottom of the page.

The washer will not operate at all.

- Is there a power failure?
- Is the power cord correctly connected to an electric outlet?
- Did you turn on the power?
- Did you press Start/Stop button?
- Is there correct amount of laundry in the washer?
- Is the door open? (The lamp “LE” will light up in this case.)

Water is not supplied

Error display **IE**

- Did you connect the inlet hoses and open water valves?
- Are the inlet hoses or water valves frozen?
- Is the water supply shut off?
- Is there debris blocking the inlet hose filters?

The washer will not drain

Error display **DE**

- Is the drain hose frozen or blocked by debris?
- Is the drain hose kinked or deformed?
- Is the end of the drain hose pushed more than 3 or 4 inches into the drain pipe?
- Check to make sure the drain filter is clean.

The washer will not spin

Error display **UE**

- Are the clothes in the drum collected on one side?
- Is the washer installed on an uneven floor or is the vibration serious?

Spinning is insufficient

Error display **PFE**

- Is the filter of the drain pump clogged?
- Does there appear to be water left in the wash drum?
- Did you use the proper amount of detergent?
- Is the drain hose placed higher than 1m above floor?

Vibrating and too noisy

- Is the washer installed on an uneven floor?
- Have all the shipping bolts removed?

Note!

- If **EB** and **E9** error mode are showed on LED panel, please contact our Customer Care Center at the number listed on the bottom of the page.

Technical information

Technical data

Dimension (inches)	27"x31"x40 1/4"(WxDxH) (Door open D: 51 1/4")
Unit Weight (lbm)	198.4(Net) / 227(Gross)
Wash capacity	3.8 cu.ft. IEC, 3.29 cu.ft. DOE
Spin Speed (RPM)	1100 rpm max.
Operating Water Pressure	4.5~145 PSI (30~1000 kPa)
Electrical Spec.	120V / 60Hz, 10 A

Installation instructions

Read these instructions carefully and completely before you install the machine. The installation should be carried out by a qualified person who is familiar with all local codes and ordinances for electrical and plumbing connections. Cosmetic damage must be reported to your dealer within five days from the date of purchase. After unpacking the washer, thoroughly check the unit for cosmetic damage.

Removing shipping bolts

1. Before operating the washer, remove the shipping bolts(4ea) along with the rubber.
 - If the bolts are not removed, it may cause heavy vibration, noise and malfunction.

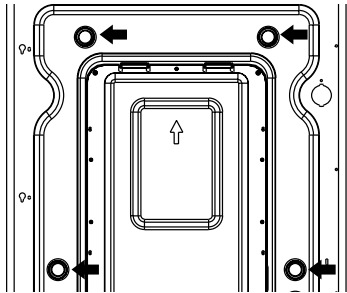

2. Unscrew the 4 bolts with the wrench supplied. Keep the 4 bolts and wrench for future use.
 - Whenever the appliance is transported, the transit bolts must be reused.

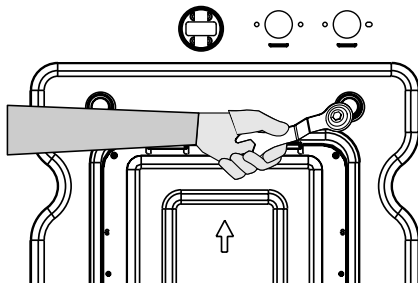

3. Close holes with supplied cap holders.

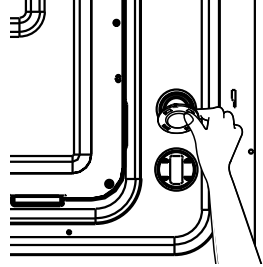

Location of your washer

- Check location where the washer will be installed. Make sure you have everything necessary for correct installation.
- Do not place or store your washer below 0C (32F) to avoid any damage from freezing.
- Do not place or store laundry products on top of washer at any times.
- Install the washer on the horizontal solid floor. If the washer is installed on an unsuitable floor, it could make considerable noise, vibrate severely and cause a malfunction. If the washer is not level, adjust the leveling legs up or down to make the unit level.
- Ventilation openings must not be obstructed by carpeting when the washer is installed on a carpeted floor.
- Leave some space. There should be at least 1/2" clearance on all sides of the unit.

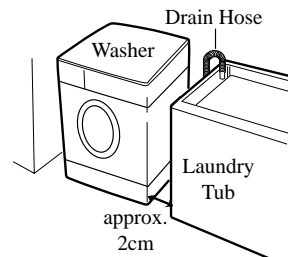

Installation instructions

Level adjustment

1. The washer must be installed on a sturdy and solid floor or the unit may make considerable noise, vibrate and cause a malfunction.
2. Adjust the level of washer using adjustable legs.
 - Please check if there is any gap between the four adjustable legs and the floor.
 - Turn the adjustable legs with the enclosed wrench to adjust the level of washer and make it sure that the machine does not move when you push on it.
 - After the adjustment are finished, turn the locking nuts up tightly so that the washer maintains the adjustment.
3. Make sure that the washer does not move when you press down on the four corners of the machine.

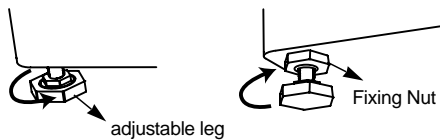

Note!

There should be no rocking of the washer and all of the adjustable legs should be sitting firmly on the floor.

Connecting water supply hoses

- Water supply pressure must be between 4.5 and 145 PSI(30~1000 kPa).
- Do not cross-thread when connecting inlet hoses to the inlet valves. If the water supply pressure is more than 145 PSI, a pressure reducing device should be installed.
- Two Sealing washers are supplied with the water inlet hoses to prevent water leaks.
- Check for leakage of washing machine connections by turning the tap completely

on.

- Periodically check the condition of the hose and replace the hose if necessary.
- Make sure that there is no kink in the hose and that it is not crushed.
- Make sure to connect the hot water valve on the machine to the hot water valve on the

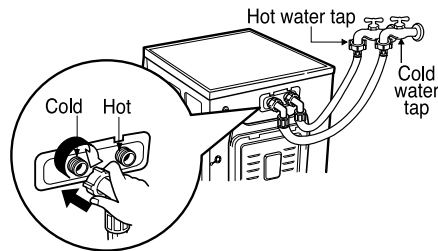

wall and that cold is connected to cold. The hot water hose has a red stripe, the cold has a blue stripe.

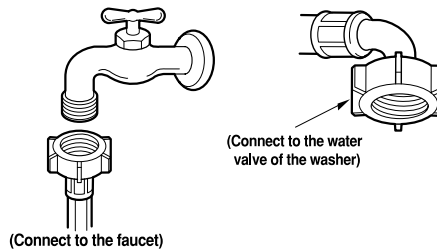

(Connect to the faucet)

Repairs to the washing machine must only be carried out by qualified personnel. Repairs carried out by inexperienced persons may cause injury or serious malfunctioning. Contact our Customer Care Center.

Do not install your washing machine in a room where temperatures below freezing may occur.

Frozen hoses may burst under pressure. The reliability of the electronic control unit may be impaired at temperatures below the freezing point. If the appliance is delivered in the winter months and temperatures are below freezing, store the washing machine at room temperature for a few hours before putting it into operation.

Installation instructions

Drain system

- Never forget to install drain hose before operating your washer.
- Open the packing box, and there is a drain hose inside the drum.
- Connect the drain hose to the drain outlet at the back side of the washer.
- Top of laundry tub must be at least 24 inches high and no higher than 40 inches from bottom of washer.
- When installing the drain hose to tub(sink), secure it tightly with a string.
- Proper securing of the drain hose will protect the floor from damage due to water leakage.

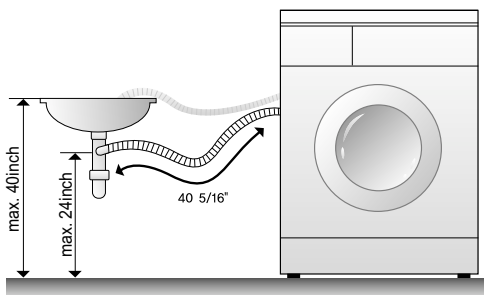

Laundry tub

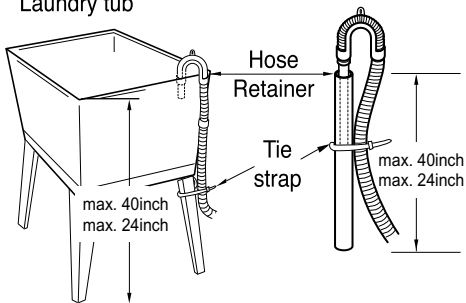

Electrical connection

- Do not use an extension cord or double adapter.
- If the supply cord is damaged, it must be replaced by a qualified person in order to avoid a hazard.
- If the machine will not be used for an extended time, unplug it and shut off the water supply.
- Connect the machine to a grounded outlet in accordance with current wiring regulations.
- The appliance must be positioned so that the plug is easily accessible.

Grounding instructions

This appliance must be grounded. In the event of malfunction or breakdown, grounding will reduce the risk of electric shock by providing a path of least resistance for electric-current.

This appliance is equipped with a cord having an equipment-grounding conductor and a grounding plug. The plug must be plugged into an appropriate outlet that is properly installed and grounded in accordance with all local codes and ordinances.

Warning!



Improper connection of the equipment-grounding conductor can result in a risk of electric shock.

Check with a qualified electrician or serviceman if you are in doubt as to whether the appliance is properly grounded. Do not modify the plug provided with the appliance. If it will not fit the outlet, have a proper outlet installed by a qualified electrician.

Installation instructions

Positioning the washer

The location must be large enough to fully open the washer door.

Washer dimensions

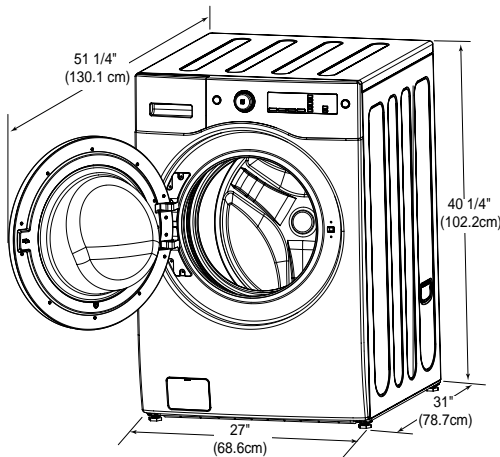

Minimum installation spacing for recessed area installation.

The following dimensions shown are for the minimum spacing allowed. Additional spacing should be considered for installation and servicing.

- Additional clearances might be required for wall, door and floor moldings.
- Additional spacing of 1/2" (1.2cm) on all sides of the washer is recommended to reduce noise transfer.
- Most installations require a minimum 1/2" (1.2cm) clearance behind the washer.

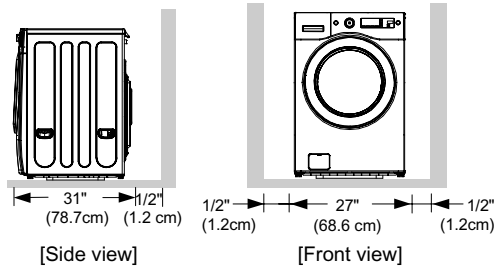

Level floor

- Allowable slope under entire washer is 1°.
- To minimize noise and vibration, the washer **MUST** be installed on a solidly constructed floor.
- Carpeting and soft tile surfaces are not recommended.
- Never install the washer on a platform or surface with poor support.

Note!

A firm, solid floor is even more critical to a front-loading washer than to a top-loader. If your floor is wood and/or frame construction, you may need to reinforce it. Front-loaders use substantially faster spin speeds than top-loaders, causing greater vibration. If the floor is not solid, your washer will vibrate. You will hear and feel the vibration throughout your house.

Power outlet

- Must be within 60 in. (1.5 m) of either side of the washer. Do not overload the outlet with more than one appliance.
- Time-delay fuse or circuit breaker is recommended.

Note!

It is the personal responsibility and obligation of the customer to have a proper outlet installed by a qualified electrician.

Service and guarantee

Asko Appliances Inc. will not pay for:

Service calls to:

1. Correct the installation of the appliance.
2. Repair damage due to shipment, delivery, installation, misuse or abuse.
3. Instruct how to use the appliance.
4. Replace house fuses or correct house wiring.
5. Correct house plumbing, including drainage problems related to improper installation.
6. Clean or service air device in drain line.
 - Repair and/or replacement parts for failure of product if appliance is used for other than home/residential use.
 - Damage resulting from accident, fire, floods, acts of God, alteration, misuse, abuse, improper installation, or installation not in accordance with local electrical or plumbing codes.
 - Any shipping costs for parts during the limited warranty period.
 - Replacement parts or repair labor costs for units operated outside the continental United States.
 - Pickup and delivery. ASKO washers are designed to be repaired in the home.

In no event shall Asko Appliances Inc. be responsible for any incidental or consequential damages.

Some states will not allow the exclusion or limitation of incidental or consequential damages, so this exclusion or limitation may not apply to you. This warranty gives you specific legal rights and you may also have other rights which vary from state to state.

For warranty service, contact our Customer Care Center at the number listed below.

Before calling for service or contacting Asko Appliances Inc. regarding a warranty issue, make a note of the model, type name, and serial number.

Write to us at:

Asko Appliances Inc.
P. O. Box 851805
Richardson, Texas 75085-1805
www.askousa.com

Or contact our

Customer Care Center at
1-800-898-1879
www.askousa.com

Service and guarantee

It is important to register your product warranty by logging onto www.askousa.com/customer-care/registration and filling out all required fields within 90 days from the date of purchase.

After doing so, you will be e-mailed a certificate that will extend the original warranty for one additional year.

If you do not have access to the internet,

complete the warranty card included with the product and mail it to the address on the warranty card within 90 days of the date of purchase. Cosmetic damage must be reported to your dealer within five days from the date of purchase. After unpacking the washer, thoroughly check the unit for cosmetic damage.

For residential installations only	Asko Appliances Inc. will pay for:
Length of warranty Two-Year Full From date of purchase.	ASKO replacement parts and/or repair labor to correct defect in materials or workmanship. Service must be provided by an authorized ASKO service agent.
Third year full Complete your product warranty registration online at www.askousa.com/customer-care/registration within 90 days from the date of purchase to extend the original warranty one additional year. If you do not have access to the internet, complete the warranty card included with the product and mail it to the address on the warranty card within 90 days of the date of purchase.	ASKO replacement parts and/or repair labor to correct defect in materials or workmanship. Service must be performed by an authorized ASKO service agent.
Lifetime	ASKO replacement parts (labor cost not included) for the stainless steel tank if it exhibits a manufacturing defect such as cracking or rusting through. Service must be provided by an authorized ASKO service agent.
For non-residential installations One-year full warranty from date of purchase	ASKO replacement parts and/or repair labor to correct defect in materials or workmanship. Service must be provided by an authorized ASKO service agent.

Quick guide

1 Washing

- Empty pockets and close zippers.
- Read the item's laundry label.
- Sorting laundry.

Note!

Place underwire bras in a laundry net.

2 Load the laundry

- Turn the unit on by pressing the main power switch.
- Load the laundry and close the door.

3 Detergent compartment

- Add detergent, fabric softener and bleach as needed into the appropriate compartments on the detergent drawer.
- If you use liquid detergent, follow the recommended dosing suggested on page 12 of this manual.
- Remember to insert the liquid detergent cup into the main wash compartment of the detergent drawer when using liquid detergent. The cup must be in place before you add liquid detergent. -Remember to insert the liquid detergent cup into the main wash compartment of the detergent drawer when using liquid detergent. The cup must be in place before you add liquid detergent.

4 Select the program

- Select a program by turning the program selector.
- Select options and settings.
- Press the Start/Stop button.

5 Program finished

- The washing machine will sound the end of wash cycle signal and automatically turn the power off.
- Remove the laundry.
If you have small children or pets at home, close the washer door once you have removed the laundry.