

This Owner's Manual is provided and hosted by [Appliance Factory Parts](http://www.appliancefactoryparts.com).

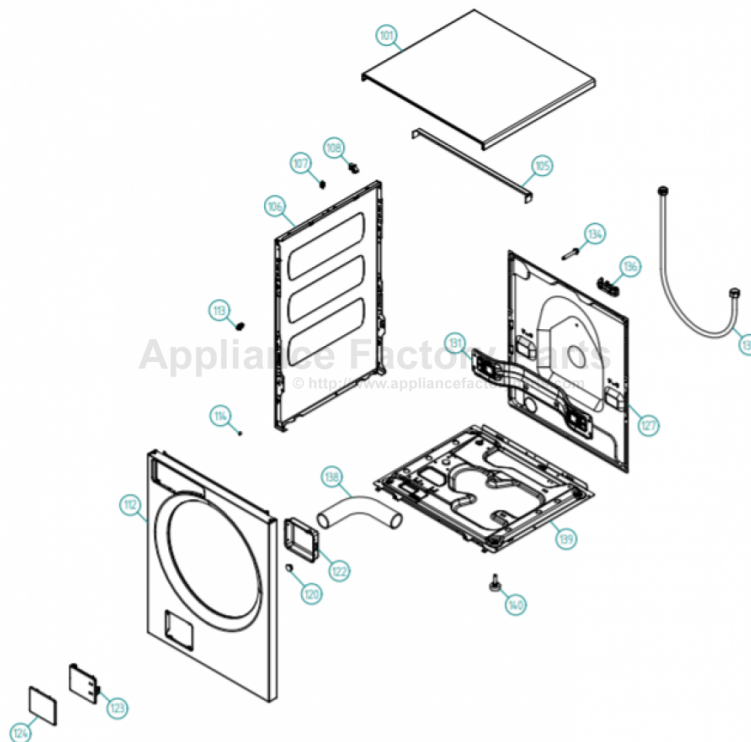

ASKO WMC64V Owner's Manual

[Shop genuine replacement parts for ASKO WMC64V](#)



[Find Your ASKO Washer Parts - Select From 53 Models](#)

----- Manual continues below -----

Operating Instructions

Washing Machine

Save these instructions for future reference

Dear Customer,

Thank you for choosing this quality product from ASKO.

We hope it will meet your expectations and fulfill your needs for many years to come. Scandinavian design combines clean lines, everyday functionality, and high quality. These are key characteristics of all our products and the reason they are greatly appreciated throughout the world.

To get the most out of your new machine, we recommend that you read the operating instructions before using it. The operating instructions also include information on how you can help protect the environment.

ASKO Professional

 **ASKO**

Contents

Before using your machine for the first time	4	Operating instructions	15
Transport protection	5	Sort your laundry.	15
Packing material	5	Turn on the main power switch	15
Washer door	5	Open the washer door and load the laundry	15
Language selection	5	Add detergent and fabric softener, as required	15
Checking water hardness	5	Select the program	16
Important safety instructions	6	Close the washer door and press the Start/Stop button	19
Grounding instructions	6	Once the program has finished	19
Installation	7	Settings	20
Overflow guard function	7	You can change the following settings:	20
Transport/Winter storage	7	Door opening	20
Disposal	7	Language	20
Child safety	8	Temperature	20
Keep an eye on children!	8	Child-safe Start	20
Child safety catch	8	Care and maintenance instructions	21
Parts of the washing machine	9	Cleaning the detergent compartment	21
Detergent compartment	10	Cleaning the outside of the machine	21
Advice and tips before washing	11	Cleaning the inside of the machine to avoid unpleasant smells	21
Sorting your laundry	11	Rinse holes under the paddle	22
Clothing	11	If you have hard water	22
Laundry labels	11	Troubleshooting	23
Colored cotton	13	The washer door will not open	23
Unbleached linen	13	The machine will not start	23
Wool	13	Error messages	24
Rayon fibers and synthetic fibers	13	Technical information	25
Detergents	13	Technical data	25
Liquid detergents	13	Transport protection	26
Recommended detergent amounts based on water hardness	14		

Contents

Installation	28
Connection to water supply	28
Electrical installation	28
Leveling the machine	28
Water supply connection	29
Drain outlet connection	29
Electrical Connections	29
Grounding instructions	30
Freestanding installation	30
Stacked installation	30
Built-in installation	30
Service	31
Warranty	32
How to contact ASKO Appliances Inc.	32
Quick guide	36

Before using your machine for the first time

Do you need this Use&Care Guide in Spanish? Log on to www.askousa.com/customer-care to download.
¿Necesita esta Instrucciones de uso y cuidado en español? Entre en www.askousa.com/customer-care y descárguela.

Before using your machine for the first time

Transport protection

Remove any transport protection devices before installing the machine. See the "Transport protection" chapter.

Packing material

Please sort waste materials in accordance with local guidelines.

Washer door

- The washer door cannot be opened until the machine is connected to the electricity supply.
- To open the door manually, see "The washer door will not open" in the "Troubleshooting" chapter.
- The machine cannot be started when the door is open.
- To open the washer door while a program is running, see "Close the door and press the Start/Stop button" in the "Operating instructions" chapter.

Language selection

You will be prompted to select the display language when you have connected your machine and start it for the first time. Do as follows:

Turn the program selector to choose from: US English, English, Svenska, Dansk, Norsk, Suomi, Français, Deutsch, Italiano, Español, Русский, Nederlands.

Press the Door Opening button or Start/Stop to save and to continue to the clock and time display settings.

Checking water hardness

The quantity of detergent needed depends, among other things, on water hardness. See the detergent pack for details. Phone your local water company to check the water hardness in your area.

NOTE!

Each machine is tested before leaving the factory. A small amount of water may remain in the drain pump, though this does not affect quality or damage the machine.

See Quick guide on the last page

Important safety instructions



SAVE THESE INSTRUCTIONS FOR FUTURE REFERENCE

WARNING!



To reduce the risk of fire, electric shock, or injury to persons when using your appliance, follow basic precautions, including the following:

- Read all instructions before using the appliance.
- Do not run appliance while you are out of the home.
- Do not wash or dry articles that have been previously cleaned in, washed in, soaked in, or spotted with gasoline, dry-cleaning solvents, cooking oils, or other flammable or explosive substances because they give off vapors that could ignite or explode.
- Do not allow children to play on or in the appliance. Close supervision of children is necessary when the appliance is used near children.
- Before the appliance is removed from service or discarded, remove the door to the washing compartment.
- Do not reach into the appliance if the drum is moving.
- Do not install or store this appliance where it will be exposed to the weather.
- Do not tamper with controls.
- Do not repair or replace any part of the appliance or attempt any servicing unless specifically recommended in the user-repair instructions or in published user-repair instructions that you understand and have the skills to carry out.
- Do not add gasoline, dry-cleaning solvents, or other flammable or explosive substances to the wash water. These substances give off vapors that could ignite or explode.
- Under certain conditions, hydrogen gas may be produced in a hot water system that has not been used for 2 weeks or more. HYDROGEN

GAS IS EXPLOSIVE. If the hot water system has not been used for such a period, before using a washing machine or combination washer-dryer, turn on all water faucets and let the water flow from each for several minutes. This will release any accumulated hydrogen gas. As the gas is flammable, do not smoke or use an open flame during this time.

WARNING!



This appliance must be properly grounded. This manual does not cover every possible condition and situation that may occur. Use common sense and caution when installing, operating, and maintaining any appliance.

Grounding instructions

A) Grounding instructions for a grounded, cord-connected appliance:

In the event of malfunction or breakdown, grounding will reduce the risk of electric shock by providing a path of least resistance for electric current. This appliance is equipped with a cord having an equipment-grounding conductor and a grounding plug. The plug must be plugged into an appropriate outlet that is properly installed and grounded in accordance with all local codes and ordinances.

WARNING!



Improper connection of the equipment-grounding conductor can result in a risk of electric shock. Check with a qualified electrician or service representative or personnel if you are in doubt as to whether the appliance is properly grounded. Do not modify the plug provided with the appliance. If it will not fit the outlet, have a proper outlet installed by a qualified electrician.

Important safety instructions



B) Grounding instructions for a permanently connected appliance:

This appliance must be connected to a grounded metal, permanent wiring system, or an equipment-grounding conductor must be run with the circuit conductors and connected to the equipment-grounding terminal or lead on the appliance.

NOTE!

This manual does not cover every possible condition and situation that may occur. Use common sense and caution when installing, operating, and maintaining any appliance.

Installation

See the "Installation" chapter.

Overflow guard function

If the machine's water level rises above the normal level, the overflow guard function begins to pump water out and shuts off the water intake. If the water level has not dropped within 60 seconds, the program is terminated.

Transport/Winter storage

If the machine is to be transported or stored in unheated premises where the temperature can fall below freezing, do as follows:

- Shut off the water to the washing machine, loosen the supply hose to the intake valve, and let the water run out from the valve and hose.

Disposal

When the machine has reached the end of its service life and is to be disposed of, it should immediately be made unusable by removing the door to the washing compartment. Contact your local authorities for information about where your machine should be disposed of and recycled in the proper way. The machine is manufactured and labeled for recycling.

SAVE THESE INSTRUCTIONS FOR FUTURE REFERENCE

Child safety

Keep an eye on children!

Be observant of children!

- Laundry detergents are corrosive, so always keep them out of reach of children.
- Should a child swallow detergent, give plenty to drink immediately, i.e., one or two glasses of milk or water. Do not try to induce vomiting. Seek medical advice immediately: The National Poison center phone number is 1-800-222-1222.
- Always close the door and start the appliance as soon as you put in the detergent.
- Always turn the power off to the machine when it is not in use.
- Always keep small children away from the machine when it is open. There may be some detergent residue left inside the machine.

- If laundry detergent gets in someone's eyes, rinse them with plenty of water for at least 15 minutes.

Child safety catch

Do as follows to open the settings menu:

1. Turn off the machine using the main power switch.
2. Press and hold the Door Opening button and then press the main power switch. Then press the Door Opening button 5 times within 10 seconds.
3. Select the setting you want to change by turning the program selector.
4. Press the Door Opening button once.
5. Change and save the setting as described below.
6. Press Start/Stop to return to the program menu.

You can activate the Child-safe Start option to prevent children from starting the machine.

1. Turn the program selector and select "Child-safe On" or "Child-safe Off".
2. Press the Door Opening button once to save the setting.

You can temporarily deactivate Child-safe Start by pressing Start/Stop and the Door Open button at the same time. Child-safe Start will be deactivated for 3 minutes.

Parts of the washing machine

1. Main power switch
2. Detergent compartment
3. Program panel
4. Serial number plate (on inside of washer door)
5. Washer door

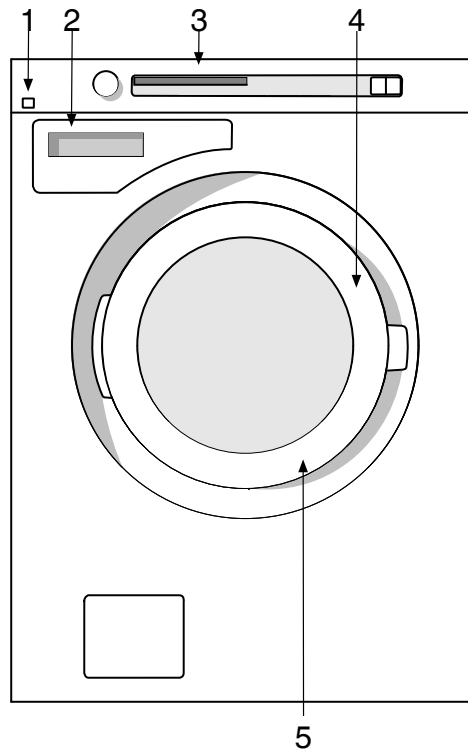

Detergent compartment

1. Pre Wash
2. Main Wash
3. Fabric softener

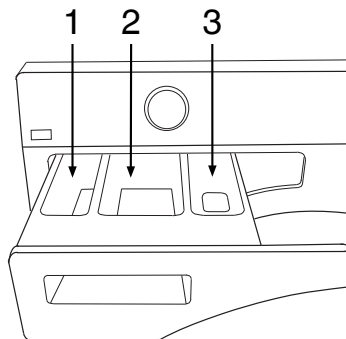
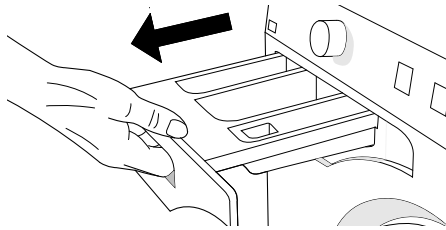

The detergent drawer automatically dispenses the detergent and fabric softener at the appropriate times. Simply pour the measured amounts of detergent and softener into the proper compartments (as illustrated) and close the drawer.

NOTE!

To avoid oversudsing, do not put detergent in the prewash compartment unless you are using one of the Heavy wash programs which has a prewash cycle.

Advice and tips before washing

Here are some tips that may help you before washing.

Sorting your laundry

Sort items according to:

- how soiled they are
- color
- material

Clothing

1. Close zippers and Velcro straps so they won't damage fabrics.
2. New colored items may contain excess dye and should therefore be washed separately the first few times.
3. Turn delicate items inside out. This reduces the risk of burling and fading.
4. Empty pockets and wash them inside out if possible.

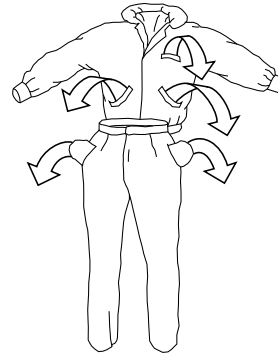







Laundry labels







Look at the item's laundry label. The table below shows suitable wash programs for different materials and wash loads. Using modern washing machines and detergents, such as compact detergents, you can usually wash at lower temperatures. It is a good idea to use trial and error to find out what produces the best results.

Advice and tips before washing



Wash cycle

-  Normal wash cycle
-  Permanent Press or Wrinkle Resistant setting
-  Gentle/Delicate setting
-  Hand wash only
-  Do not wash
-  Do not wring, Hang dry, drip dry, or dry flat

Wash water temperature

-  Maximum water temp 200° F/95°C
-  Maximum water temp 160° F/70°C
-  Maximum water temp 140° F/60°C
-  Maximum water temp 120° F/50°C
-  Maximum water temp 105° F/40°C
-  Maximum water temp 85° F/30°C





Bleach instructions

-  Any bleach when needed
-  Only non-chlorine bleach
-  Do not bleach





Dry clean symbol

-  Dry clean only





Tumble dry cycle

-  Machine dry
-  Normal setting
-  Permanent Press or Wrinkle Resistant setting
-  Gentle or Delicate setting
-  Do not tumble dry







Tumble dry heat setting

-  Any heat
-  High heat
-  Medium heat
-  Low heat
-  No heat/Air fluff

Special drying instructions

-  Line dry or hang to dry
-  Drip dry (do not spin or wring)
-  Dry flat
-  Dry in shade

Ironing instructions

-  Ironing is necessary
-  High temperature setting
-  Medium temperature setting
-  Low temperature setting
-  Do not iron or press with heat
-  Iron without steam

Advice and tips before washing

Colored cotton

Colored cotton items labeled 140 °F (60 °C) should be washed at 140 °F (60 °C) the first time in order to remove any excess dye. If you do not do so, there is a risk that the color will run. Use detergent without bleach in order to preserve the color of the fabric.

Unbleached linen

Unbleached linen fabrics should be washed at 140 °F (60 °C), using detergent containing no bleach or optical whiteners. Heavily-soiled linen can occasionally be washed at higher temperatures, but not too often as the heat can destroy the linen's sheen and strength.

Wool

These fabrics are labeled either machine wash or hand wash. The Wool/hand wash, 86 °F (30 °C) program is at least as gentle as washing by hand.

Rayon fibers and synthetic fibers

Materials made of rayon fibers, such as viscose, and some synthetic fibers are very delicate and require much space to avoid wrinkling. Only half fill the drum when washing and choose a spin speed of 800 rpm or lower.

NOTE!

Viscose and acetates are fragile when wet.

Detergents

Eco-labeled detergents are less harmful to the environment.

Detergent overdosing does not give better washing results; it merely causes a greater impact on the environment.

Try to use less detergent, and increase only if you are not satisfied with the results.

NOTE!

Due to environmental concerns, we discourage the use of strong chemicals.

When using agents for bleaching or stain removal, there is a risk of rust (corrosion) and discoloration of the machine.

Liquid detergents

We don't recommend liquid detergents because they tend to produce more suds than powder detergents when used in water temperatures of 150° F or higher. If you should try a liquid detergent, start with a very small amount, such as 1 to 2 tablespoons. Also, liquid detergent can be used for all programs without prewash, so add it into the main wash compartment.

Detergents

Laundry detergents are available in low-, normal- and high-sudsing formulas. A detergent's ability to clean is not relative to the amount of suds it produces. Excess suds in a front-loading washer actually interfere with the cleaning because they cushion the tumbling action. Also, high-sudsing detergents are more difficult to completely rinse out.

The use of anything other than a low-sudsing detergent can cause severe oversudsing, which could cause suds to backup through the detergent compartment and run down the front of the washer onto the floor. If oversudsing occurs, run the wash through one or more rinse programs until all items are thoroughly rinsed. Remove the laundry then run the washer through a Normal wash program to get rid of any remaining detergent.

We recommend that you don't use bleach in your ASKO washer. The tumbling wash action, temperature control options, extended wash times and proper amount of detergent are sufficient to remove most stains.

Advice and tips before washing

Recommended powder detergents

ASKO washers use 50% to 75% less detergent than most other washers. This is because of their low water consumption and the fact that all the wash water is repeatedly circulated through the laundry, ensuring that all the detergent is fully utilized. We recommend that you use powder detergents made specifically for front-loading washers. These are sometimes called HE (High-Efficiency) detergents. Please visit our homepage www.askousa.com to see the powder detergents we recommend for ASKO washers.

We recommend that you do not use any powder detergent that doesn't wash completely out of the detergent drawer.

Detergent Amounts Based on Water Hardness

The amount of detergent needed can vary due to differences in water hardness. To determine the water hardness in your area, contact your local water utility or area water softening company. The harder the water, the more detergent you may need. Refer to the chart below for the recommended detergent amounts based on water hardness. Remember, you should adjust the amount of detergent you use by small amounts until you find the correct amount.

Recommended detergent amounts based on water hardness

Detergent amounts		
Water hardness	Pre Wash	Main Wash
Soft (0-3 grains per gal.)	1 teaspoon	1 to 1-1/2 tablespoons
Medium (4-8 grains per gal.)	1 teaspoon	1 to 2 tablespoons
Hard (9+ grains per gal.)	1 teaspoon	2 to 3 tablespoons

Note that 12 grains and higher is extremely hard water and detergent alone may not be enough. You may need to use a water softener to maximize the performance of your washer. Also, in areas with hard water (9+) you may need to wash at lower temperatures to prevent hard water deposits from forming in the tank and wash system.

Amount of detergent to use

The amount of detergent needed varies among the different brands, but for most detergents, you need only one or two tablespoons. Using too much detergent can result in detergent residue being left in your clothes, which can cause them to appear gray or dingy. You should start with a small amount of detergent and increase it only if the cleaning results are unsatisfactory.

Additionally, you should never put detergent in the prewash compartment unless you are using a wash program that has a prewash cycle. This could cause excess foaming, which could damage the machine.

The amount of detergent needed can also depend on the hardness of the water in your area. See the "Detergent Amounts Based on Water Hardness" section on the next page for more details.

Operating instructions

WARNING!



To reduce the risk of fire, electric shock, or injury to persons, read the IMPORTANT SAFETY INSTRUCTIONS before operating this appliance.

1 Sort your laundry.

See the "Advice and Tips before washing" section.

Place underwired bras in a laundry net.

Empty pockets. Coins, nails, and the like can cause damage to the machine and fabrics. See the "Advice and Tips" section before washing.

2 Turn on the main power switch

3 Open the washer door and load the laundry

If the washer door is closed, press the Door Opening button (key symbol). The door opens once all water has drained from the machine. Load the laundry. The wash program chart shows how much laundry can be washed with each program.

4 Add detergent and fabric softener, as required

The detergent packaging will have recommendations for how much detergent you should use. The machine holds 18 lb (8 kg) of laundry. If you only have a small amount of laundry in the machine, you can reduce the amount of detergent used.

Powder detergent

Pour the powder into the main wash compartment, and pre-wash compartment as well if desired.

Liquid detergent

When using liquid detergent, follow the chart on page 15 for recommended detergent amounts. We recommend always using a wash ball with very thick liquid detergent.

Wash ball or net

If you use a wash ball or net, place it directly in the drum and select a program without pre-wash.

NOTE!

Detergent overdosing does not give better washing results; it merely causes a greater impact on the environment.

Try using less detergent, and increase only if you are not satisfied with the results.

Fabric softener

Pour the fabric softener into the compartment with the  symbol. Follow the recommendations on the fabric softener packaging.

NOTE!

Do not fill above the compartment's maximum fill level. Otherwise fabric softener will be dispensed too early, which impairs the washing effect.

WARNING!



To reduce the risk of fire, electric shock, or injury to persons, read the IMPORTANT SAFETY INSTRUCTIONS before operating this appliance.

Operating instructions

5 Select the program

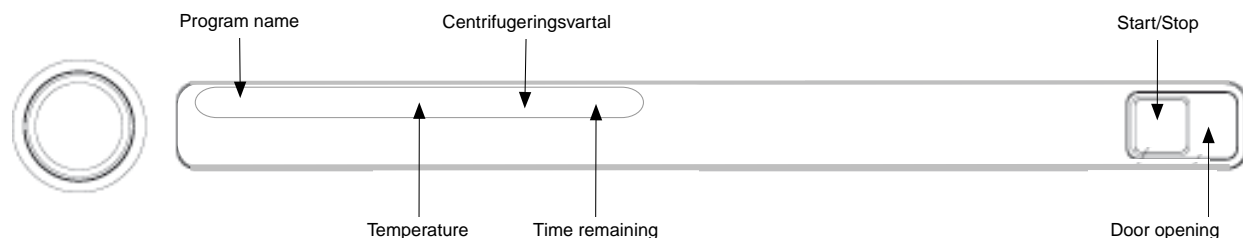

The display shows the program name, the water temperature, and the spin speed.

The washing machine has a number of preselected programs when delivered from the factory. The preselected programs can be replaced. Contact the Customer Care Center for information on which programs are available and how to alter the preselected programs.

Normal Hot, 140 °F (60 °C)

Program for normally to heavily soiled laundry, whites and colors. Follow the washing instructions for each garment. 140 °F (60 °C) is a good temperature for garments worn next to the skin. This program has five rinses.

Normal Warm, 104 °F (40 °C)

Program for normally to heavily soiled laundry, whites and colors. Follow the washing instructions for each garment. This program has five rinses.

Heavy Wash, 194 °F (90 °C)

Program for heavily soiled laundry, with dirt that needs to be fully dissolved before the main wash. A pre-wash is used to do this.

Heavy Wash, 140 °F (60 °C)

Program for heavily soiled laundry, with dirt that needs to be fully dissolved before the main wash. A pre-wash is used to do this.

Sani, 194 °F (90 °C)

Program for normally to heavily soiled laundry. Follow the washing instructions for each garment. 194 °F (90 °C) is a good temperature for white and light-colored cotton, such as bed linen.

White, 140 °F (60 °C)

Program for normally soiled laundry, whites and colors. Follow the washing instructions for each garment. 140 °F (60 °C) is a good temperature for garments worn next to the skin.

Colour, 104 °F (40 °C)

Program for normally soiled laundry, whites and colors. Follow the washing instructions for each garment.

Quick wash, 140 °F (60 °C)

Fast program for laundry that just needs freshening up. Follow the washing instructions for each garment. Garments worn next to the skin ought to be washed at 140 °F (60 °C).

Super quick wash, 104 °F (40 °C)

Fast program for laundry that just needs freshening up. Follow the washing instructions for each garment.

PermaPress, 104 °F (40 °C)

Program for synthetics, delicate blended materials, and permanent press cotton. Suitable for shirts and blouses. Follow the washing instructions for each garment. Many synthetics will come clean at 104 °F (40 °C).

Wool/hand wash, 86 °F (30 °C)

A gentle laundry program for wool, silk, and garments that should be washed by hand. The program has a short spin.

Operating instructions

Rinse

This program performs one cold rinse cycle + spin. Suitable for laundry that just needs to be dampened.

MOP Wash, 194 °F (90 °C)

Program suitable for different types of mop. The program has two rinses that use a large amount of water.

MOP Wash, 140 °F (60 °C)

Program suitable for different types of mop. The program has two rinses that use a large amount of water.

Micro fibre wash, 140 °F (60 °C)

Program for laundry made of microfibers, such as microfiber cloths. The program has three rinses, and uses a large amount of water in the first rinse.

Micro fibre wash, 104 °F (40 °C)

Program for laundry made of microfibers, such as microfiber cloths. The program has three rinses, and uses a large amount of water in the first rinse.

Disinfection, 104 °F (40 °C)

Program where the temperature reached during the main wash is maintained for 20 minutes.

Disinfection at this temperature requires special detergent.

Disinfection, 140 °F (60 °C)

Program where the temperature reached during the main wash is maintained for 20 minutes.

Disinfection at this temperature requires special detergent.

Disinfection, 194 °F (90 °C)

Program where the temperature reached during the main wash is maintained for 10 minutes. This temperature is sufficient for disinfection without special detergent.

Program A

No information available

Program B

No information available

Program C

No information available

Operating instructions

Program chart

Program	Pre Wash	Temp. °F	Number of rinses	Spin speed rpm	Max. load (lb)	Water consumption (approx. gallon)	Energy consumption (approx. kWh)	Program time (approx. hrs and min.)
Normal Hot, 140 °F (60 °C)		140	5	1400	18	21,1	1.2	3:05
Normal Warm, 104 °F (40 °C)		104	5	1400	18	21,1	0.7	2:55
Heavy Wash, 194 °F (90 °C)	X	194	3	1400	18	19,8	2.3	1:35
Heavy Wash, 140 °F (60 °C)	X	140	3	1400	18	17,2	1.1	1:15
Sani, 194 °F (90 °C)		194	3	1400	18	13,2	1.3	0:60
White, 140 °F (60 °C)		140	3	1400	18	11,9	0.3	0:50
Colour, 104 °F (40 °C)		104	3	1400	18	13,2	0.3	0:50
Quick wash, 140 °F (60 °C)		140	3	800	9	9,2	0.6	0:30
Super quick wash, 104 °F (40 °C)		104	3	800	9	9,2	0.3	0:25
PermaPress, 104 °F (40 °C)		104	3	800	9	10,6	0.3	0:25
Wool/hand wash, 86 °F (30 °C)		86	3	800	6	15,9	0.3	0:30
Rinse			1	1400	9	5,3	0.1	0:15
MOP Wash, 194 °F (90 °C)	X	194	2	1400	18	9,2	1.2	1:00
MOP Wash, 140 °F (60 °C)	X	194	2	1400	18	7,9	0.3	0:40
Micro fibre wash, 140 °F (60 °C)		140	3	1400	18	9,2	0.3	0:50
Micro fibre wash, 104 °F (40 °C)		104	3	1400	18	10,6	0.3	0:50
Disinfection, 104 °F (40 °C)	X	104	3	1400	18	18,5	0.7	1:15
Disinfection, 140 °F (60 °C)	X	140	3	1400	18	18,5	1.5	1:25
Disinfection, 194 °F (90 °C)	X	194	3	1400	18	21,1	2.6	1:45
Program A								
Program B								
Program C								

Operating instructions

6 Close the washer door and press the Start/Stop button

Time remaining

"Program Started" is shown on the display.

When the program starts, an estimated program time, in hours and minutes, is displayed. The remaining time is updated three times during the program, based on the actual load and the incoming water temperature. The first update takes place after about 15 minutes. The remaining time is last updated just before the final rinse.

To add or remove laundry after the program starts

If you want to add or remove items after the program has started, you can stop the program by pressing and holding the Door Opening button (key symbol) for three seconds. When you restart the machine, add any extra detergent needed and close the washer door. The machine continues automatically from the point where the program was interrupted.

Stopping or changing a program

You can stop a program by pressing the Start/Stop button for three seconds. "Stop" appears on the display. To restart the machine, select a new program, add any extra detergent needed, and press the Start/Stop button.

NOTE!

Do not open the detergent compartment while the machine is running.

7 Once the program has finished

Once a program has finished, "End" appears on the display.

The washer door opens automatically once the program has finished. If you want to deactivate the Automatic Door Opening function, see the "Selecting settings" section.

- Remove the laundry.
- Turn off the main power switch as this will save energy.

If you have small children or pets at home, close the washer door once you have removed the laundry.

Backlighting

Two minutes after the wash program finishes the display backlighting enters energy saving mode.

Settings

You can change the following settings:

- Language
- Child-safe Start
- Door opening
- Temperature °C/°F

Do as follows to open the settings menu:

1. Turn off the machine using the main power switch.
2. Press and hold the Door Opening button and then press the main power switch. Then press the Door Opening button 5 times within 10 seconds.
3. Select the setting you want to change by turning the program selector.
4. Press the Door Opening button once.
5. Change and save the setting as described below.
6. Press Start/Stop to return to the program menu.

Door opening

If you do not want the washer door to open automatically when the program is finished, you can deactivate this function.

1. Turn the program selector and choose "Automatic Door Opening On" or "Automatic Door Opening Off".
2. Press the Door Opening button once to save the setting.

Language

1. Turn the program selector to choose from: US English, English, Svenska, Dansk, Norsk, Suomi, Français, Deutsch, Italiano, Español, Русский, Nederlands.
2. Press the Door Opening button once to save the setting.

Temperature

1. Turn the program selector to choose between: °C and °F.
2. Press the Door Opening button once to save the setting.

Child-safe Start

You can activate the Child-safe Start option to prevent children from starting the machine.

1. Turn the program selector and select "Child-safe On" or "Child-safe Off".
2. Press the Door Opening button once to save the setting.

You can temporarily deactivate Child-safe Start by pressing Start/Stop and the Door Open button at the same time. Child-safe Start will be deactivated for 3 minutes.

Care and maintenance instructions

Cleaning the detergent compartment

NOTE!

Do not run the detergent compartment through a dishwasher!

Pull the detergent compartment out as far as it will go.

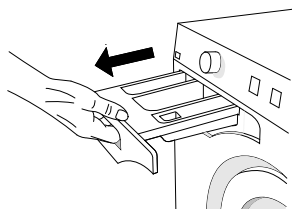

Lift the detergent compartment as you pull it out to remove it from the machine.

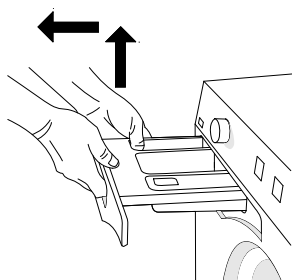

Rinse the compartment and scrub it clean. The fabric softener compartment cover can be removed.

Cleaning the outside of the machine

Clean the outside of the machine and the program panel with a mild cleaner. Do not use any solvents, as these can damage the machine.

NOTE!

Do not hose down the machine with water!

Cleaning the inside of the machine to avoid unpleasant smells

Modern detergents often allow laundry to be washed at low temperatures. This means that small deposits can build up in the machine. These, in turn, may lead to unpleasant odors developing.

To avoid this, we recommend running a 203 °F (95 °C) wash program once a month. When you do this, use a small quantity of detergent. It is not necessary to put any laundry in the machine.

Care and maintenance instructions

Rinse holes under the paddle

If you suspect that objects such as nails or paper clips may have fallen into the wash drum, you should check the space under the paddles. Such objects can rust and cause spots on clothing. Nails and other sharp objects can cause holes in fabrics.

Do as follows:

1. Insert a screwdriver or similar tool into the hole on the paddle as illustrated and carefully push to the left.

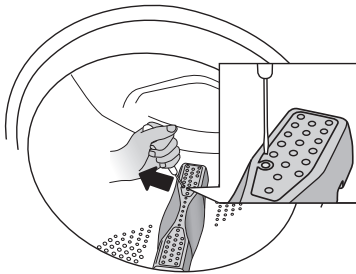

2. Use your other hand to grasp the paddle and pull it toward you.

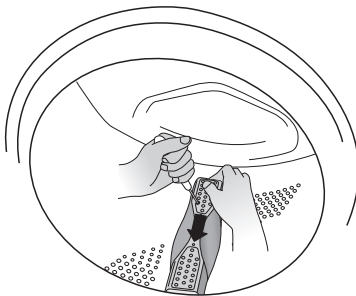

3. Lift the paddle.
4. Remove any objects.
5. Place the paddle in the mounting hole with the F-mark toward you. Ensure that all the paddle fasteners are in their holes in the drum. Push it in until it catches.

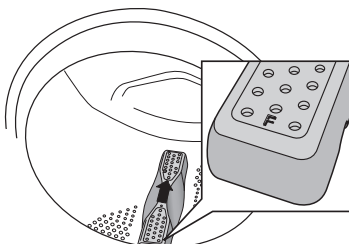

If you have hard water

If you live in an area with hard water (high limescale content), a grayish-white coating may form on the wash drum. To remove this coating, pour approximately 20 gram (1 oz) of citric acid into the wash drum and run any 203 °F (95 °C) program. Repeat if necessary.

Troubleshooting

The washer door will not open

1. Check that the main power switch is on.
2. Is there power? Check your home's fuses (circuit breakers). The washer door cannot be opened with the door opening button (with the key symbol) if the power is off.

If nothing else works, the washer door can be opened as follows:

WARNING!



The door may only be opened manually if the electric power is cut and the machine has been drained of water.

- A First, empty the water from the washing machine. Press and hold the Door Opening button for three seconds to pump out the water.
- B Ensure that the main power switch is turned off and that the plug has been removed from the wall socket.
- C Take the emergency door opening tool and place it in the gap on the right side of the washer door lock. This tool is found in the enclosed plastic bag.
- D Push the tool upward to open the washer door.

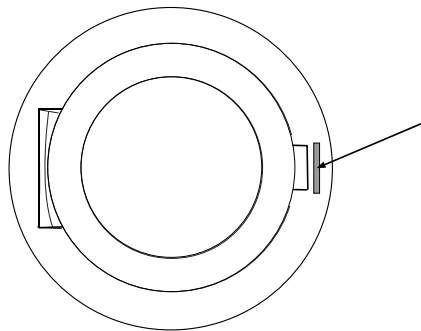

If in the future the washer door does not open when the wash program has finished, call the Customer Care Center.

The machine will not start

1. Is the washer door properly closed? Push it firmly.
2. Is there power? Check the fuses and residual current devices (circuit breakers) in the building.

Troubleshooting

Error messages

If an error occurs during the program, a message is shown on the display. To exit the message after taking action, turn the machine off and then back on.

The error messages that may be shown in the display are:

Close the door

Close the washer door and the program will start.

Overfilling

1. Shut off the water tap.
2. See "Drainage error".

Drainage error

Press the Door Opening button (key symbol) to empty the machine of water before opening the washer door. If this does not resolve the problem, call the Customer Care Center.

Water Inlet Fault

Check:

- that the tap on the water pipe is open.
- that the filter in the machine's water intake is not blocked.

Action:

1. Shut off the water tap.
2. Unscrew the hose.
3. Clean the filter in the intake valve on the machine.
4. Screw the hose back on.
5. Turn on the tap.
6. Run the program again to check whether the error has been fixed.
7. If this does not resolve the problem, call the Customer Care Center.

Door opening error

Contact the Customer Care Center at the number listed at the bottom of this page!

Motor fault

Contact the Customer Care Center at the number listed at the bottom of this page!

Imbalance

The machine stops the spin cycle if there is too much imbalance. The washing machine restarts the spin cycle and hopefully the laundry is better distributed in the drum. This procedure can be repeated up to 10 times. If the machine still fails to find a good balance, the program jumps to the next step.

The error message requires no action.

Technical information

Technical data

Height:	33 1/2" (850 mm)
Width:	23 1/2" (597 mm)
Depth:	23 7/8" (606 mm)
Weight:	161 lb (73 kg)
Cylinder volume:	15,9 gal (60 l)
Max. laundry capacity:	18 lb (8 kg)
Spin speed (rpm):	400-1400
Rated power:	See serial number tag and rating plate.
Heater output:	See serial number tag and rating plate.
Water pressure:	14-145 psi
Wash drum and liquid compartment material:	Stainless steel
Outer casing material:	Powder-coated and hot-galvanized sheet steel or stainless steel.
Water connection:	59" (1.5 m) pex pipe
Drain:	67" (1.7 m) polypropylene hose

Transport protection

Your washing machine has transport protection of Type A or Type B.

Type A

Before the machine is used, the three transport screws should be removed as shown below.

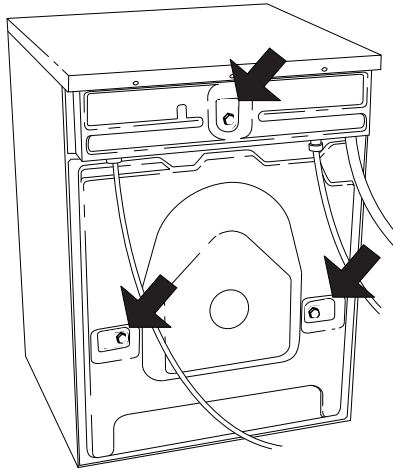

1. Loosen and remove the bolts.

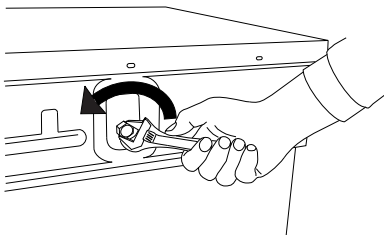

2. The enclosed plastic bag contains three plastic plugs to fit in the empty screw holes.

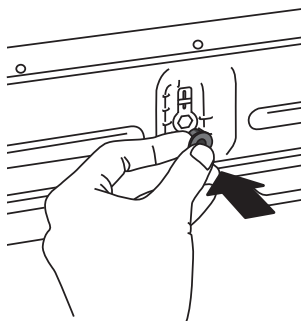

NOTE!

If the machine is to be moved and transported, the transport screws must be refitted to prevent damage to the machine through shaking. If the transport screws or plastic plugs have been lost, you can order new ones from your retailer.

Article number	Designation
----------------	-------------

80 882 77	Screw
-----------	-------

80 884 67	Plastic plug
-----------	--------------

Order three of each item!

Transport protection

Type B

Remove the three transport bolts and the plastic plugs for locking the machine for transport before using the machine.

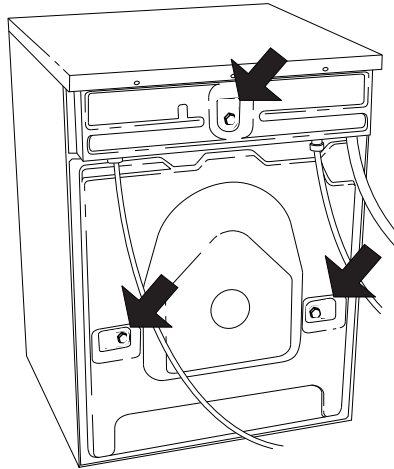

1. Loosen and remove the bolts as illustrated below.

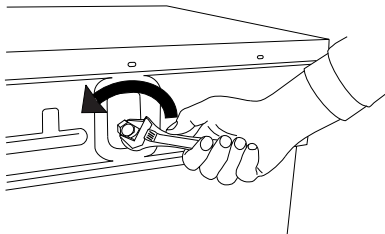

2. To remove the plastic plugs that held the bolts, squeeze together and pull out.

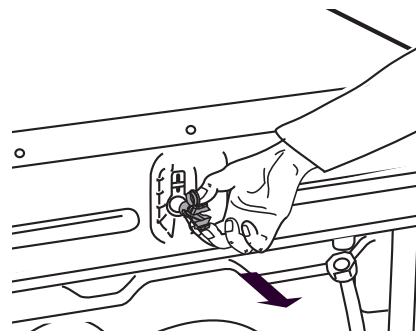

3. Remove the plastic covers from the plugs. Push the plastic covers into the three holes that contained the plugs. Save the plastic plugs in case the machine is moved in the future.

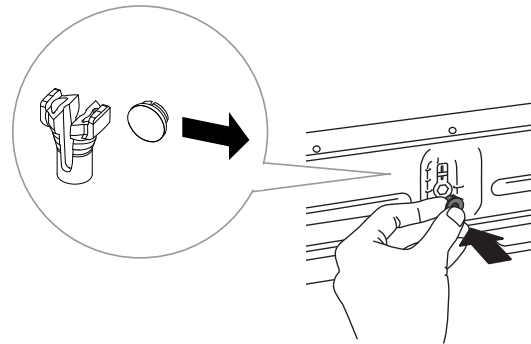

NOTE!

If the machine is to be transported, the bolts and plastic plugs for locking the machine during transport must be installed to prevent damage to the machine through shaking. If the transport bolts or plastic plugs have been lost, you can order new ones from your retailer.

Article number	Designation
80 882 77	Screw
80 901 05	Plastic plug, transport lock

Order three of each item!

Installation

Connection to water supply

Water intake

At the factory, the machine is set for connecting to both hot and cold water supplies. The machine can be set for a cold water supply only. This setting must be changed by a qualified professional. Contact the Customer Care Center.

Electrical installation

Coin operation

The machine is prepared for coin operation. Such installation must be carried out by a qualified professional.

The installation requires a connection cable to power the coin meter. This connection cable can be ordered as an accessory using spare part number 92 090 95.

The coin meter must be able to short circuit two signal lines for periods of up to 10 minutes. This is to give the user time to load the machine, choose a program, and start the program after inserting the coins.

"Insert coin" appears on the display when the machine is started with the main power switch.

Read these instructions carefully and completely before you install the machine. The installation should be carried out by a qualified person who is familiar with all local codes and ordinances for electrical and plumbing connections.

Cosmetic damage must be reported to your dealer within five days from the date of purchase. After unpacking the washer, thoroughly check the unit for cosmetic damage.

Leveling the machine

It is important that the machine is level to prevent excessive vibrations during spin cycles. Each foot of the washer is adjustable, so you can level the washer on any surface. Once it is level, securely tighten the lock nuts on the feet to prevent excessive vibration during spin cycles.

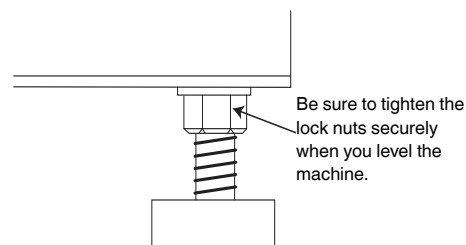

Installation

Water supply connection

Since ASKO washers have a built-in heating element, you only need a cold water inlet. The connection should be made by someone who is sufficiently skilled. Use the hose supplied with the washer. (The inlet hose is marked for correct connection.) The water pressure must be in the range 15–146 PSI. A valve should be fitted on the water supply pipe. If a new supply pipe has been installed for the washer, it should be flushed thoroughly to remove any foreign particles that might clog the filter in the fill valve.

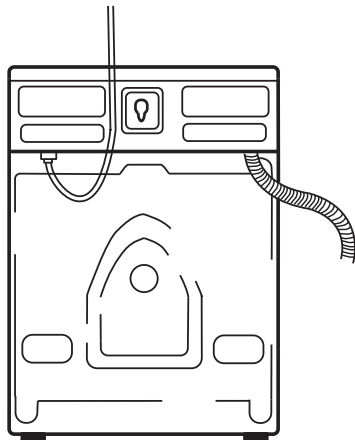

NOTE!

If the unit is installed on a second storey, follow local building codes. We recommend installing a drip pan.

Drain outlet connection

The machine is supplied with the outlet hose already attached. The hose should be extended over a suitable sink edge or drain pipe at a height of 24" to 36" (610 mm to 914 mm) above the bottom of the unit. (The lower height is preferable.) Make sure the hose is not kinked.



NOTE!

If the hose is extended, the internal diameter of the coupling must not be less than 1/2".

WARNING!



Do not extend the drain hose higher than 36" (914 mm) from the bottom of the unit.

Electrical Connections

The machine is delivered ready-fitted with a plug and is intended for connection to an ASKO Dryer, which is equipped with a matching receptacle. The plug supplied with the washer can only be used with an ASKO Dryer. If the washer is used separately or with another dryer, it must be on a separate 208-240 V single-phase circuit.

If the machine is to be used in a wet area, the supply must be protected by a residual current device.

As supplied: 208-240 V, 60 Hz, 3000 W heating element, 16 A fuse required.

Installation

WARNING!



Connection to a permanently wired supply point must be made only by a qualified electrician

Grounding instructions

This appliance must be grounded. In the event of malfunction or breakdown, grounding will reduce the risk of electric shock by providing a path of least resistance for electric current. This appliance is equipped with a cord having an equipment-grounding conductor and a grounding plug. The plug must be plugged into an appropriate outlet that is properly installed and grounded in accordance with all local codes and ordinances.

Freestanding installation

The washer can be placed next to the dryer. It is essential that the machine is leveled and the locknuts are tightened to prevent excessive vibration during spin cycles. Also be sure to leave a minimum of $\frac{1}{2}$ " of space between the washer and the dryer. The height adjustment for the washer is $33\frac{1}{2}$ " to $34\frac{1}{2}$ " (850 mm to 876 mm). Do not raise it higher than $34\frac{1}{2}$ " (876 mm).

WARNING!



Improper connection of the equipment-grounding conductor can result in a risk of electric shock. Check with a qualified electrician or serviceman if you are in doubt as to whether the appliance is properly grounded.

Do not modify the plug provided with the appliance. If it will not fit the outlet, have a proper outlet installed by a qualified electrician.

Stacked installation

ASKO washers should never be stacked on a counter or a dryer. You can, however, stack an ASKO dryer on an ASKO washer. Refer to your Dryer Use and Care Guide for instructions on how to do this.

Built-in installation

ASKO washers can be installed beneath a cabinet or worktop with a height of 34" to 35" (863 to 889 mm) or in a closet. There must be a gap of about $\frac{1}{2}$ " (12 mm) all around the machine, including between the rear edge of the machine's top panel and the back wall. The opening width must be at least $24\frac{1}{2}$ " (622 mm). Space must also be available for the fill and drain hoses. See the illustration below for measurements and positions. If the washer is installed in a closet the door must be left open while the washer is running.

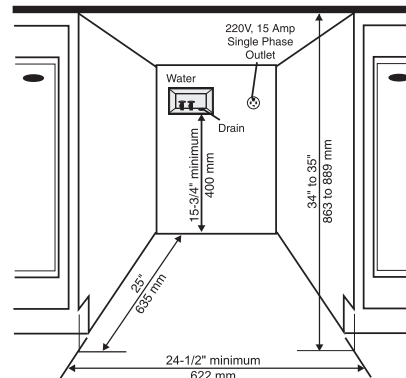

If the drain outlet is higher than 24" (610 mm), the connections will need to be recessed.

Service

It is important to register your product warranty by logging onto "<http://www.askousa.com/customer-care/register-my-appliance/>" and filling out all required fields within 90 days from the date of purchase. After doing so, you will be e-mailed a certificate that will extend the original warranty for one additional year. If you do not have access to the internet, complete the warranty card included with the product and mail it to the address on the warranty card within 90 days from the date of purchase. Cosmetic damage must be reported to your dealer within five days from the date of purchase. After unpacking the washer, thoroughly check the unit for cosmetic damage.

For residential installations only	ASKO Appliances Inc. will pay for:
Length of warranty Two-Year Full From date of purchase.	ASKO replacement parts and/or repair labor to correct defect in materials or workmanship. Service must be provided by an authorized ASKO service agent.
Third Year Full Complete your product warranty registration online at " http://www.askousa.com/customer-care/register-my-appliance/ " within 90 days from the date of purchase to extend the original warranty one additional year. If you do not have access to the internet, complete the warranty card included with the product and mail it to the address on the warranty card within 90 days from the date of purchase.	ASKO replacement parts and/or repair labor to correct defect in materials or workmanship. Service must be performed by an authorized ASKO service agent.
Lifetime	ASKO replacement parts (labor cost not included) for the stainless steel tank if it exhibits a manufacturing defect such as cracking or rusting through. Service must be provided by an authorized ASKO service agent.
For non-residential installations One-year Full Warranty From date of purchase.	ASKO replacement parts and/or repair labor to correct defect in materials or workmanship. Service must be provided by an authorized ASKO service agent.

Service

Warranty

ASKO Appliances Inc. will not pay for:

- Service calls to:
 1. Correct the installation of the appliance.
 2. Repair damage due to shipment, delivery, installation, misuse or abuse.
 3. Instruct how to use the appliance.
 4. Replace house fuses or correct house wiring.
 5. Correct house plumbing, including drainage problems related to improper installation.
 6. Clean or service air device in drain line.
- Repair and/or replacement parts for failure of product if appliance is used for other than home/residential use.
- Damage resulting from accident, fire, floods, acts of God, alteration, misuse, abuse, improper installation, or installation not in accordance with local electrical or plumbing codes.
- Any shipping costs for parts during the limited warranty period.
- Replacement parts or repair labor costs for units operated outside the continental United States.
- Pickup and delivery. ASKO products are designed to be repaired in the home.

In no event shall ASKO Appliances Inc. be responsible for any incidental or consequential damages.

Some states will not allow the exclusion or limitation of incidental or consequential damages, so this exclusion or limitation may not apply to you. This warranty gives you specific legal rights and you may also have other rights which vary from state to state.

For warranty service, contact our Customer Care Center at the number listed below.

Before calling for service or contacting ASKO Appliances Inc. regarding a warranty issue, make a note of the model, type name, and serial number.

How to contact ASKO Appliances Inc.

Write to us at:

ASKO Appliances Inc.

P.O. Box 940609

Plano, TX 75094-0609

www.askousa.com

Or contact our

Customer Care Center at

1-800-898-1879

www.askousa.com

Notes

Notes

Notes

Quick guide

1 Washing

1. Empty pockets and close zippers.
2. Read the item's laundry label.
3. Sorting laundry.

NOTE!

Place underwired bras in a laundry net.

2 Load the laundry

1. Pressing the main power switch.
2. If the washer door is closed, press the Door Opening button (key symbol) and the door will open.
3. Load the laundry and close the washer door.

3 Detergent compartment

1. Pour detergent into the main wash compartment, and pre-wash compartment as well if required. Pour fabric softener into the compartment on the right with the  symbol.

2. If you use liquid detergent, follow the detergent manufacturer's recommendations.
3. If you use liquid detergent, use the accompanying divider. Place it in the filter at the back of the detergent compartment. Pour detergent directly into the main wash compartment.

4 Select the program

1. Select a program by turning the program selector.
2. Press the Start/Stop button.

5 Program finished

1. "End" on the display indicates that the wash program has ended.
2. The washer door opens automatically once the program has finished.
3. Remove the laundry.
4. Turn off the main power switch.

If you have small children or pets at home, close the washer door once you have removed the laundry.