

This Owner's Manual is provided and hosted by [Appliance Factory Parts](http://www.appliancefactoryparts.com).

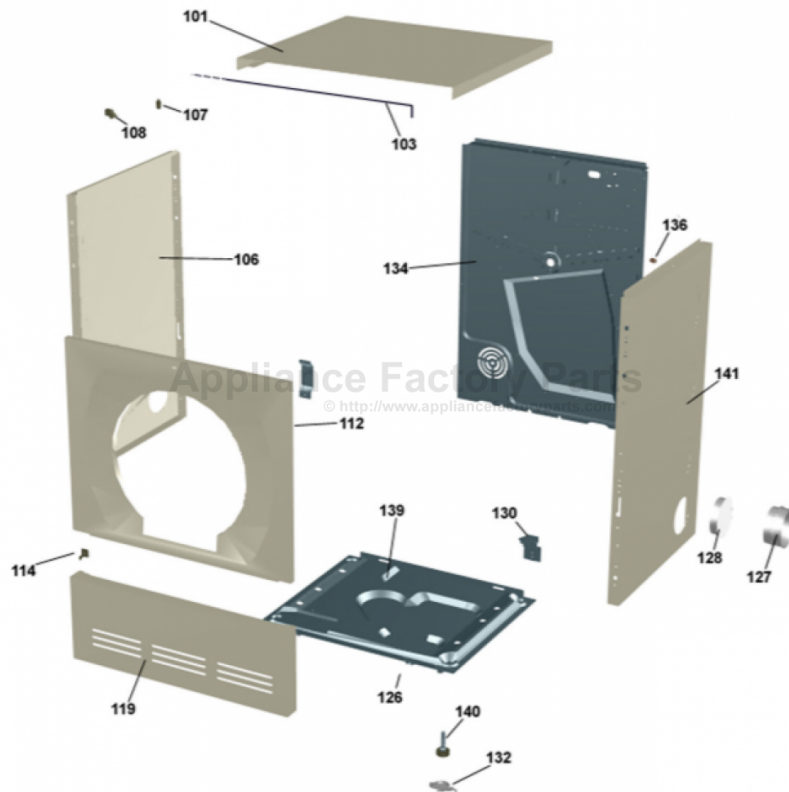

ASKO T760WH Owner's Manual

[Shop genuine replacement parts for ASKO T760WH](#)



[Find Your ASKO Dryer Parts - Select From 74 Models](#)

----- Manual continues below part list -----

Available Replacement Parts for ASKO T760WH

[8065710](#)

BELT ASKO



DRYER USE AND CARE GUIDE

ENGLISH

IMPORTANT!
To get the best performance from
your dryer, read all operating
instructions before using it for
the first time.



FRANÇAIS

CONTENTS

Important Safety Instructions	2
Safety Features	2
ASKO Dryer Features	3
Care and Maintenance Instructions	4
Overheat Protection	6
Troubleshooting	6
Energy Saving Tips	6
Customizing the Preset Programs – T760/T780	7
Error Messages – T760/T780	9
Installation Instructions	10
ASKO Product Warranty	15
Index	16

ESPAÑOL

SAVE THESE INSTRUCTIONS FOR FUTURE REFERENCE

IMPORTANT SAFETY INSTRUCTIONS

To reduce the risk of fire, electric shock, or injury to persons when using your appliance, follow basic precautions, including the following:

- ◆ Electrical installation, if required, must be done by a licensed electrician.
- ◆ Read all instructions before using the appliance.
- ◆ Do not allow children to play on or in the appliance. Close supervision of children is necessary when the appliance is used near children.
- ◆ Before the appliance is removed from service or discarded, remove the door to the drying compartment.
- ◆ Do not reach into the appliance if the drum is moving.
- ◆ Do not install or store this appliance where it will be exposed to the weather.
- ◆ Do not tamper with controls.
- ◆ Do not use fabric softeners or products to eliminate static unless the manufacturer gives written assurance that the product will not damage a tumble dryer.
- ◆ Do not heat dry items containing:
 - vinyl, plastic, foam rubber or similarly textured rubberlike materials
 - fiberglass
 - wool unless the label specifies “washable”
- ◆ Do not heat dry items that have been dry-cleaned at home.
- ◆ Clean the lint filter before or after each load.
- ◆ Keep the area around the exhaust opening and adjacent areas free from the accumulation of lint, dust, and dirt.
- ◆ The interior of the machine and exhaust duct should be cleaned periodically by an authorized ASKO service agent.
- ◆ Do not attempt to repair or replace any part of the appliance or perform any servicing unless specifically recommended in this guide.

- ◆ The dryer is made and marked to facilitate recycling. When it is no longer useful, contact your local refuse collection service for advice on how to properly dispose of the dryer for purposes of recycling.

WARNING!

This appliance must be properly grounded. Improper connection of the equipment grounding conductor can result in a risk of electric shock. Check with a qualified electrician or serviceman if you are in doubt as to whether the appliance is properly grounded.

The plug must be plugged into an appliance outlet that is properly installed and grounded in accordance with all local codes and ordinances.

To reduce the risk of fire, this appliance must be exhausted outdoors or the equivalent. Do not exhaust into a chimney, wall, ceiling or concealed space in a building.

WARNING!

Do not wash or dry articles that have been previously cleaned in, washed in, soaked in, or spotted with gasoline, dry-cleaning solvents, cooking oils, other flammable or explosive substances as they give off vapors that could ignite or explode.

NOTE: This manual does not cover every possible condition and situation that may occur. Use common sense and caution when installing, operating, and maintaining any appliance.

SAFETY FEATURES

Magnetic Door Lock

ASKO dryers have a magnetic door lock that allows the door to be opened from the inside.

Automatic Door Switch

A door switch automatically stops the dryer when the door is opened. The dryer will not start again until you close the door and press the Start button.

Overheat Protection

ASKO dryers have an overheat protection switch that automatically turns off the machine if the temperature gets too high. Refer to page 6 for more information.

Child-Safe Start Feature

You can program Models T760 and T780 not to start unless the Start button is held down for three seconds. This is to prevent children from inadvertently starting the machine. Refer to page 9 for instructions on how to program this safety feature.

ASKO DRYER FEATURES

Your new energy-efficient ASKO dryer is designed to give you maximum drying performance using less energy. To make the most of the dryer's functions and features, we recommend that you read this manual carefully before using your machine for the first time. For operating instructions specific to your model, refer to the *Quick Start Guide* enclosed with this manual.

Below is an illustration of the parts and features of your ASKO dryer.

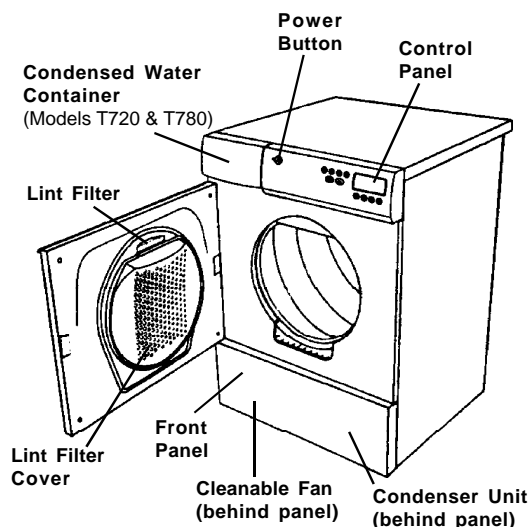

ASKO dryers come with three different drying systems:

Sensidry™

Models T760 and T780 have our state-of-the-art Sensidry system. These machines are equipped with a humidity sensor that ensures different fabrics always dry thoroughly. This sensor turns off the heat when the laundry has reached the appropriate dryness.

Thermostat-Control

Model T700 has a thermostat that controls the temperature by turning the heating element on and off to maintain the selected drying temperature (Normal or Low) within +/- 5° F.

Timer-Control

Model T720 offers only timed drying. You can set the dryer to run from 30 minutes to 190 minutes.

Model T700 has timer-controlled drying in addition to the two automatic (thermostat-controlled) programs.

When using a timed drying program, be careful not to leave the clothes in too long. It's best to use a shorter time; then if the load isn't dry, you can set the timer for a few more minutes.

CARE LABEL INSTRUCTIONS

Read all permanent care labels carefully. If the label says "Drip dry," "Line dry" or "Dry flat," do not dry that item in the dryer. Certain fabrics will melt or become dangerously flammable if heated, while others may lose their shape.

NOTE: Refer to "Important Safety Instructions" on the previous page for a list of specific materials that should never be put in a tumble dryer.

SORTING THE LAUNDRY

For best drying results, clothes should be sorted properly. Below are some suggestions on how to sort your laundry for drying.

- ◆ Permanent press items should be dried together. For the most wrinkle-free results when drying permanent press items, you should fill the machine only half full. These items also should be removed promptly from the dryer and hung up or folded right away.
- ◆ Dry heavy fabrics together and lightweight fabrics together.
- ◆ Dry fabrics that *shed* lint (chenille, terry cloth, etc.) separately from fabrics that *collect* lint (synthetics, velveteen, corduroy, etc.).
- ◆ Separate non-colorfast fabrics from light-colored items.
- ◆ If the care label says "Wash Separately," the fabric is likely to lose color (excess dye) for the first few washings. To minimize the possibility of the dye transferring to white or lighter colored items, dry new colored garments with items of similar color or alone. Bright reds and oranges on cottons are the dyes most likely to transfer colors.

FABRIC SOFTENER SHEETS

We recommend that you do not use fabric softener sheets in the dryer. Over time, the chemicals on these sheets can build up inside the lint filter and clog the holes that circulate the air.

DRYING PROGRAMS

Refer to the *Quick Start Guide* that came with your dryer for specific instructions and programs available with the model you purchased.

Models T760 and T780: Refer to the "Customizing the Preset Programs" on page 7 of this guide for instructions on how to change the preset programs.

DRYING TIMES

Drying times will vary due to the amount of laundry in the machine, moisture content, type of fabric, air temperature and humidity. The length of the vent hose can also affect drying times. (See "Connecting to a Ventilation Duct (T700/T760)" on page 11 for the recommended installation.)

RECOMMENDED TEMPERATURE SETTINGS AND LOAD SIZES

Different fabrics require different load sizes and drying temperatures. The table below gives recommended

temperature settings and load sizes for different fabrics.

Fabric Type	Temp Setting	Load Size
Cotton w/out elastic and/or decorative trim	Normal	Full
Linen – white and colorfast	Normal	Half
Cotton/polyester blends	Low	Half
Polyester/acrylic blends	Low	Half
Rayon and acetate	Low	Half
Washable silk and nylon *	Low	Third
Washable wool and wool blends *	Low	Third
Handwash wool and silk *	Low	Third

* Always refer to the care label on the garment to determine if it can be tumble dried. Some wool and silk and hand-washable items should not be tumble dried. These items should be removed from the washer then pressed out in a terry towel to remove excess water before being hung up or laid flat to dry.

CARE AND MAINTENANCE INSTRUCTIONS

CLEANING THE LINT FILTER

The wear on fabrics in a tumble dryer is insignificant. The lint caught in the lint filter is dust and fiber residue that has been formed when the garments have been worn. The lint filter must be cleaned after *each* load. If this is not done, drying performance will suffer, as insufficient air will pass through the drum. The machine may also overheat after a while, which will cause it to stop automatically.

To clean the lint filter, follow the steps below:

1. Grasp the handle and pull it toward you.
2. Remove the filter from the holder.
3. Open the filter and gently brush away any lint.
4. Fold the filter together and return it to the holder on the door.
5. Push the holder in until it snaps into place.

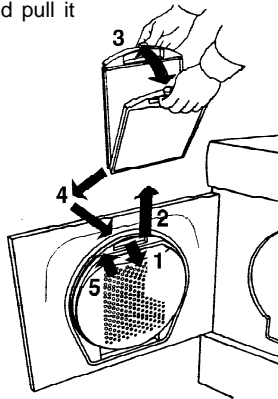

CLEANING THE CONTROL PANEL

To clean the control panel, use only a soft, warm, damp (not wet) rag. To prevent penetration of water into the door lock and electrical components, **do not use a spray cleaner of any kind**. Also, never use abrasive cleaners or scouring pads on the outer surfaces because they will scratch the finish and possibly remove the writing on the control panels. Some paper towels may also scratch the finish.

CLEANING THE EXHAUST HOSE

About once a year you should remove the exhaust hose and clean it. At this time, you should also clean the exhaust outlet on the machine and the ventilation duct.

Periodically, you should check the dryer exhaust outside to be sure the air flow is strong and nothing is blocking the vent.

T720 AND T780 - EMPTYING THE WATER CONTAINER

If the dryer is not installed to pump out the condensed water into a drain or sink, the condensation water collects in the water container to the left of the control panel. You should empty the container every three to five dryer loads, depending on the spin speed you use when you wash the clothes. For example, clothes spun at 800 rpm will have more moisture when you take them out of the washer than clothes spun at 1400 rpm. Therefore, the dryer will have to remove more water.

NOTE: Do not remove the water container while the machine is running.

1. Pull out the container.
2. Pour out the water.
3. Replace the container. You should hear it snap into place.

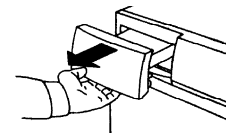

NOTE: The condensed water is soft and safe to use for watering plants.

If the container becomes too full, the machine will shut down. To restart the program, empty the container and press Start. It may be a few minutes before the machine starts because it drains the excess water from the sump before it restarts.

CLEANING THE FAN

The fan should be cleaned at least once a year. If you have pets, you should clean it more often. To clean the fan, follow the steps below:

1. Turn off the main power to the machine.

2. Remove the two 20 torx screws on the bottom of the front panel then grasp the bottom of the panel and pull it forward and down.

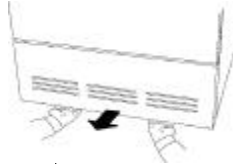

3. Unscrew the 10 torx safety screw on the bottom of the fan cover and fold out the four tabs.

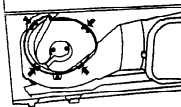

4. Remove the fan cover.

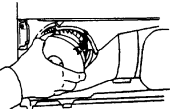

5. Hold the fan in place while you unscrew the nut.

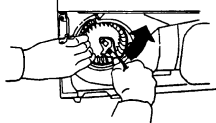

6. Pull out the fan and clean it with a brush and water.



7. Replace the fan and screw the nut securely.



8. Replace the fan cover and fold the lugs back into place. Replace the safety screw.



9. Replace the front panel.

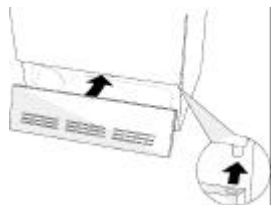

10. Turn back on the main power.

T720 AND T780 - CLEANING THE CONDENSER

The condenser should be cleaned on a regular basis, preferably monthly. If you have pets, you should probably clean it more often. To clean the condenser, follow the steps below:

1. Turn off the main power to the machine.

2. Remove the two 20 torx screws on the bottom of the front panel then grasp the bottom of the panel and pull it forward and down.

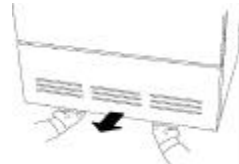

3. Turn the levers on the condenser cover counter-clockwise to release it then pull it down.

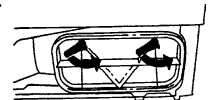

4. Pull out the condenser.

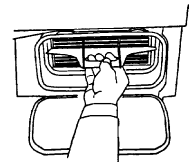

5. Spray the fins with warm water until all of the lint is removed.

WARNING!

Do not put the condenser into a dishwasher. Do not use any sharp metal objects or a wire brush to clean the condenser. Also, do not poke anything between the fins.



6. Make sure the side marked "UP" does face up and carefully replace the filter into the unit.



7. Replace the condenser cover and the front panel.

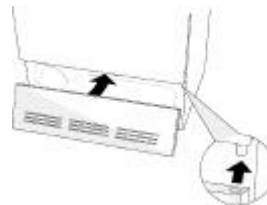

8. Turn back on the main power.

TROUBLESHOOTING

If you experience a problem with your dryer, you should review the following list of frequently encountered situations. It could save you the cost and inconvenience of a service call.

Even though the product is under warranty, if the problem

is not caused by defective product workmanship or materials, you will be charged for a service call. Refer to page 15 to determine what is and is not covered under your warranty. If you're still not sure, contact the ASKO Advisory Center before you call a serviceman.

The machine won't start.

- ◆ Make sure the door is closed securely.
- ◆ Make sure the Power is turned on.
- ◆ Check that you set the program or time correctly.
- ◆ Check that the electric plug is securely in the socket.
- ◆ Check the house breaker/fuses and the fuses on the back of the dryer.
- ◆ If all of the above options are eliminated, the overheat protection has probably been activated. (See below.)

The machine starts but it stops when I release the power button.

- ◆ The overheating protection has probably activated. Clean the lint filter and let the machine cool down before trying again. (See below.)

The machine takes too long to dry my laundry.

- ◆ Check that the lint filter is clean.
- ◆ If you use dryer sheets (not recommended), you may need to wash the lint filter with warm water and a soft brush to clean any blocked holes.
- ◆ Be careful not to overload the dryer because the warm air needs sufficient room to circulate properly

and the clothes need room to tumble freely.

- ◆ The laundry should only be damp when it comes out of the washer. If it seems too wet, try using a faster or longer spin cycle.
- ◆ Make sure the outside vent exhaust is not blocked.

My clothes are coming out wrinkled.

- ◆ You should remove the clothes as soon as the dryer signals the end of the cycle. If you can't remove the clothes right away, use the Anti-crease option.
- ◆ Dry heavy fabrics together and light fabrics together.
- ◆ Dry only permanent press items together.
- ◆ Dry in smaller loads.
- ◆ Use slower spin speeds.
- ◆ Use fabric softener in the rinse program.
- ◆ You may be using the wrong wash temperature. Try using a lower wash temperature, especially for permanent press and delicate items.

The motor is running but the drum isn't turning.

- ◆ This usually means a belt is broken. Call a servicer.

The machine makes a funny noise.

- ◆ A slight rumbling may be heard when you first turn on the dryer. This is normal and it should only last a few seconds.

OVERHEAT PROTECTION

ASKO dryers are designed with an overheat protection switch that automatically turns off the machine if the temperature is too high. This could happen if the lint filter or exhaust hose becomes clogged with dust.

Should the machine turn itself off because of overheating, make sure the lint filter and exhaust hose and vent duct are clean.

If the overheat protection switch is activated, you have to reset it before the machine will run. To do this, press the reset button (rubber disk) on the back of the machine, as illustrated to the right. You should hear a click when it engages. The machine will not start until it has cooled sufficiently.

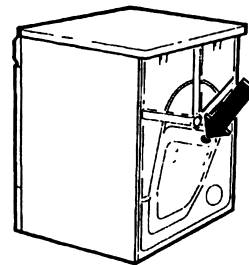

Press the reset button to start the machine.

NOTE: If your dryer overheats frequently, it may not be vented properly or the room in which it is located may not have sufficient air circulation. Contact an installer to have these issues checked out.

ENERGY SAVING TIPS

- ◆ Dry consecutive loads to avoid reheating the dryer.
- ◆ Do not overload the dryer.
- ◆ Use the highest spin speeds allowed for the garments.
- ◆ Do not put extremely wet clothes into the dryer.
- ◆ Dry like fabrics together (i.e., heavy fabrics together, light fabrics together).
- ◆ Clean the lint filter after each load.
- ◆ Do not overdry clothes when using the timed program.
- ◆ Spin the clothes at no less than 800 rpm.

T760/T780 – CUSTOMIZING THE PRESET PROGRAMS

ASKO's EasyControl™ panel makes it simple to customize the preset programs to perfectly fit your laundry needs. You needn't worry about making an error

because you can easily restore the original program settings. (See page 9.)

THE PRESET PROGRAMS

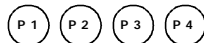

Before we tell you how to customize the preset programs, you need to review what these programs are. The table below lists the four preset programs and the pre-

programmed settings for each. To select a program, simply press one of the program buttons then press Start.

Preset Program	Dry Cycle	Dry Temp	Cooling Time	Buzzer	Anti-Crease
P1	Extra Dry	Normal	Normal ⁽¹⁾	On	1 hr.
P2	Dry	Normal	Normal	On	1 hr.
P3	Normal Dry	Normal	Normal	On	1 hr.
P4	Iron Dry	Normal ⁽²⁾	Normal	On	1 hr.

NOTES: (1) The Normal cooling time is 20 minutes.

(2) Model T760 is preset for Low dry temperature.

WARNING! Some fabrics may not be able to withstand extremely hot temperatures. Please refer to the "Recommended Temperature Settings and Load Sizes" chart on page 4.

CUSTOMIZING THE PROGRAMS

Below are the basic instructions for changing a preset program. The following page explains the menus and options and how to navigate through them.

1. Press the button for the preset program you want to change (P1–P4). The program you select will display in the lower left corner of the LED window.
2. Press MENU to display different program and option settings.
3. Press the Arrows to move forward or backward through the menu settings.
4. Press ENTER to choose your selection.

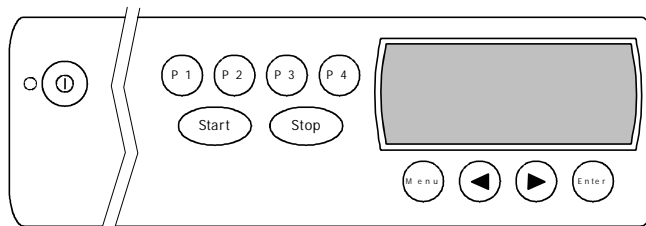

THE PROGRAM MENU

The following table lists all of the programs on the Program menu as well as the settings and options available with each. It's a good idea to scan through the

menus a couple of times and familiarize yourself with the options before you make any changes. And remember, it's easy to restore the preset programs.

Programs	Available Options
Extra Dry	Normal Cooling (20 min.) or Quick Cooling (10 min.); Buzzer On/Off; 0–3 hr. Anti-crease; Normal or Low Temperature, 1–12 hr. Delay Start
Dry	Normal Cooling (20 min.) or Quick Cooling (10 min.); Buzzer On/Off; 0–3 hr. Anti-crease; Normal or Low Temperature, 1–12 hr. Delay Start
Normal Dry	Normal Cooling (20 min.) or Quick Cooling (10 min.); Buzzer On/Off; 0–3 hr. Anti-crease; Normal or Low Temperature, 1–12 hr. Delay Start
Iron Dry	Normal Cooling (20 min.) or Quick Cooling (10 min.); Buzzer On/Off; 0–3 hr. Anti-crease; Normal or Low Temperature, 1–12 hr. Delay Start
Air Fluff	5–90 min. cycle time; Buzzer On/Off; 0–3 hr. Anti-crease, 1–12 hr. Delay Start
Timed Dry	All drying programs; 5–90 min. cycle time; Normal Cooling (20 min.) or Quick Cooling (10 min.); Buzzer On/Off; 0–3 hr. Anti-crease; Normal or Low Temperature; 1–12 hr. Delay Start

NAVIGATING THE MENUS

The following paragraphs explain how to navigate through the menus and change the preset programs. If you don't want to make changes in all of the menus, continue to press MENU until the one you do want to change displays.

To restore a preset program to its original settings, simply press the button for the preset program (P1–P4) you want to restore and hold it down while you press ENTER. The program will instantly revert to its original settings.

We recommend that you make two or three trial changes to understand how easy it is to customize these program.

Remember, the first step to customizing a preset program is to press the button for the program you want to customize (P1–P4).

The Program Menu

The Program menu lets you set the dry program you prefer. You would also use this menu to set the machine for a Timed Dry or Air Fluff program. (See "Timed Dry and Air Fluff" on this page.)

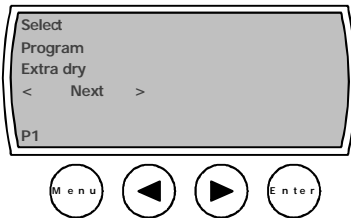

1. Use the Arrow buttons to move through the program choices (Extra Dry, Dry, Normal Dry, etc.)
2. When your preference displays, press ENTER. The LED will display the new program setting.

Press MENU to advance to the next menu or press START to begin the program.

The Options Menu

This menu lets you set several options (such as, turning the buzzer off and on, setting the anti-crease run time, etc.) Only the options available with the program you selected will display. (See "The Program Menu" on page 7.)

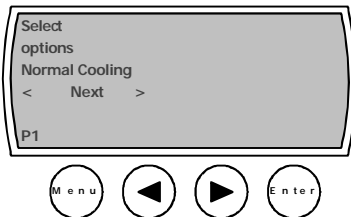

1. On this menu, you press ENTER to advance through the options, rather than pressing MENU.
2. Press an Arrow button to toggle between Off and On.
3. When your preference displays, press ENTER. The LED will display the new options.

Press MENU to advance to the next menu or press START to begin the program.

The Temperature Menu

This menu lets you set the dry temperature. Only the temperatures available for the dry program you selected will display.

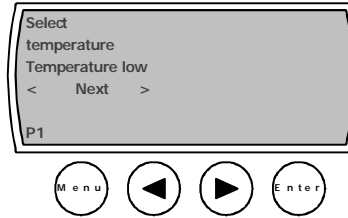

1. Use the Arrow buttons to toggle between the Normal and Low temperature settings.
2. When the setting you prefer displays, press ENTER. The LED will display the new temperature setting. Press MENU to advance to the next menu or press START to begin the program.

Timed Dry and Air Fluff

When you select Timed Dry or Air Fluff on the program menu, the word "Time" and a number (of minutes) will flash in the upper right corner of the LED window. This indicates you must select a program time (5 to 90 minutes).

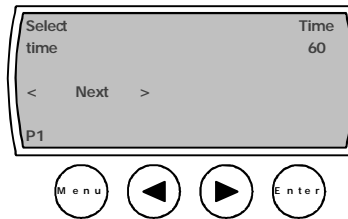

1. To change the number, simply press an Arrow button until the length of time you want the program to run displays.
2. Press ENTER to program your change.

Press MENU to advance to the next menu or press START to begin the program. When you press START, the time remaining for the program to run displays in the bottom right-hand corner of the LED window, as illustrated below:

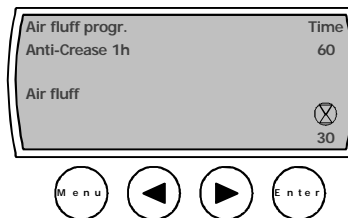

NOTE: The remaining time toggles between the minutes remaining (e.g., 23) and the hour(s) remaining (e.g., 1h).

The Delayed Start Program

This program lets you delay starting the dryer for up to 12 hours. This feature is useful in areas where utility companies offer discount rates during certain hours.

When you select Delayed Start on the program menu, you must select a delay time (1 to 12 hours).

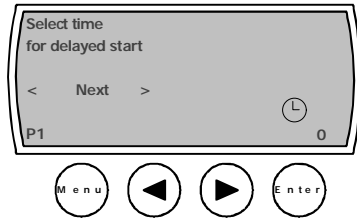

1. In the bottom right corner of the LED window, a clockface and a zero will flash. To change the zero, simply press an Arrow button until the number of hours you want to delay starting the program displays (1–12 hours).

2. Press ENTER to program your change.

Press MENU to advance to the next menu or press START to begin the program. When you press START, the clockface and the hours you set for the delay will display, as illustrated below:

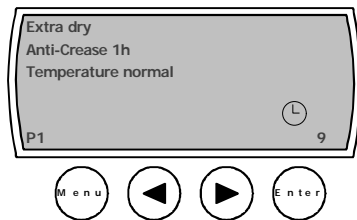

RESTORING A PRESET PROGRAM

To restore a preset program to its original settings, simply press the button for the preset program you want to restore and hold it down while you press ENTER. The program will revert to its original settings.

CHANGING THE LANGUAGE ON THE LED DISPLAY

There are eleven languages available for the LED window:

- ◆ English
- ◆ French
- ◆ Spanish
- ◆ Portuguese
- ◆ Italian
- ◆ German
- ◆ Swedish
- ◆ Danish
- ◆ Norwegian
- ◆ Netherlands
- ◆ Finnish

To change the language, follow the steps below:

1. Turn the machine off then on again.
2. Press **ENTER** five times in succession then press **P1** five times. (This must be done within 15 seconds.)
3. When the Language menu displays, press an Arrow button to advance through the menu to the desired language.
4. Once the correct language displays, press ENTER to program the LED window to display the language you selected.

CHILD-SAFE START

As a safety measure, you can program the T760 and T780 not to start unless the Start button is held down for three seconds. To do this, follow the steps below:

1. Turn the machine off then on.
2. Press ENTER five times, then press P3 five times. (This must be done within 15 seconds.)
3. “Delayed start” displays with “0” flashing in the lower right corner. Press the right Arrow button to toggle the display to “3.”

Child-Safe Menu Button

Please note that when you set the child-safe Start button, the Menu button is *automatically* programmed to delay for three seconds before it becomes active. This prevents a child from accidentally changing the program settings.

When you want to change a program, press the Menu button for three seconds to activate the menus. The Menu button will work normally (without the 3-second delay) until you have completed your changes. If it is not pressed for two minutes, it will automatically revert back to the child-safe mode.

ERROR MESSAGES - T760/T780

Error messages will display in the LED window if a fault occurs while a program is in progress. The table below defines each possible error message. If the

message still displays after you have checked the possible solutions, call a service technician.

ERROR MESSAGE	SOLUTION
Three hours	Make sure both fuses are intact. Clean the lint filter. Make sure exhaust hose is clear (T760). Clear message by turning the power off then on.
Overflow (T780)	Make sure the condensed water container is empty. If draining into a drain pipe, make sure the black rubber hose is not kinked or blocked. The drain should not be higher than 40 inches from the floor. Make sure the condensation pump is not blocked.
Sensor	This can appear if there are dry clothes in the drum when the unit is started. Cancel the error message by opening the door or turning the power off then on.
Thermistor	Call a service technician.

INSTALLATION INSTRUCTIONS

Read these instructions carefully and completely before you install the machine. The installation should be carried out by a qualified person who is familiar with all local codes and ordinances for electrical and plumbing connections.

NOTE: Cosmetic damage must be reported to your dealer within five days from the date of purchase. After unpacking the dryer, thoroughly check the unit for cosmetic damage.

SPECIFICATIONS

Height	33-1/2"–34-1/2" (850–876 mm)	Outer casing	Stove-enamelled hot-dipped galvanized steel
Width	23-7/16" (595 mm) Plus exhaust hose connection	Power requirement	2800 watts
Depth	T760/T780: 23-7/16" (595 mm) T700/T720: 24-7/16" (620 mm)	For connection	Single-phase, 230 V, 30 Amp
Weight	86 lbs (39 kg)	Internal fuse	15 amp.
Drum material	Stainless Steel	Heating element	2500 watts

CONNECTING AIR EXHAUST (T700 AND T760)

The exhaust hose can be connected at the rear or on either side of the dryer. When the machine is delivered, the exhaust outlet at the rear is open.

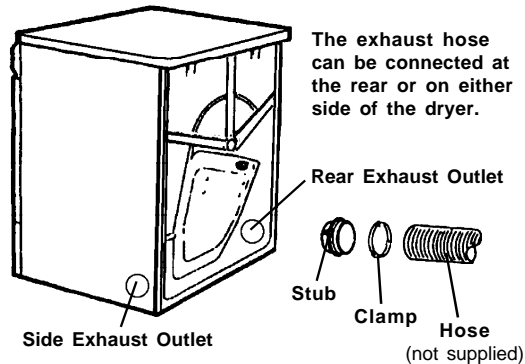

The dryer is shipped with a stub pipe already installed on the rear exhaust outlet. The consumer or installer must purchase a UL-CSA-approved exhaust hose.

Rear Outlet Hose Connection

To connect the exhaust hose to the rear outlet, follow the steps below:

1. Push the hose onto the stub pipe and secure it with a clamp.
2. With the hose attached, insert the stub pipe into the hole. It should snap into place.

NOTE: After you push the dryer into place, check for kinks in the hose. (Be careful not to use too much hose.)

Connecting the Vent Hose to the Left or Right Side Outlet

To connect the exhaust hose to the left or right side outlet, follow the steps below:

1. Using a flathead screwdriver, turn the exhaust outlet cover to align the tabs holding the cover in place. Remove the cover.
2. Remove the stub pipe from the rear exhaust outlet.
3. Place the stub pipe in the outlet you plan to use.
4. Follow the instructions for the rear outlet hose connection.
5. Use the exhaust outlet cover you removed from the side to cover the rear exhaust outlet.

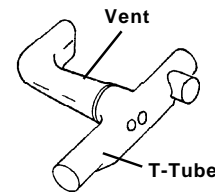

WARNING!

To reduce the risk of fire, this appliance must be exhausted **OUTDOORS** or the equivalent.

Never cover the end of the dryer stub or vent hose with anything to catch lint, except for UL approved vent basket.

CONDENSATION DRAIN CONNECTION (T720 AND T780)

If possible, you should install the dryer so the condensed water will continuously flow into a drain or sink. To do this, follow the instructions below:

1. Disconnect the short hose (1) from the blue connection. (It's okay to let the hose hang down.)
2. Connect the rubber hose supplied with the dryer to the blue nipple (2).
3. Run the hose to a drain or sink, as illustrated.

NOTE: The drain hose must not be more than 40" above the floor.

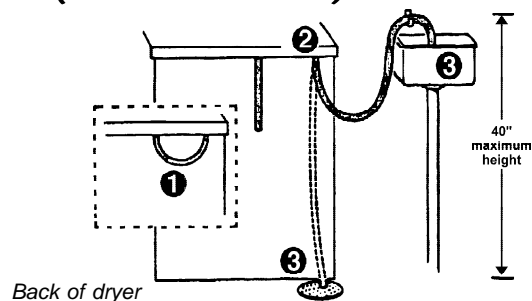

CONNECTING TO A VENTILATION DUCT (T700/T760)

1. Connect the exhaust hose to a ventilation exhaust fitting or to a discharge through the wall.
2. Secure the hose joint to the outlet stub on the machine.
3. Run the hose with as few bends as possible to the point of discharge. If necessary, it can be extended to a maximum of 22 feet (660 cm) of 4" (10 cm) diameter ridged pipe.

Make any bends as gentle as possible. A maximum of four 90° bends may be fitted in the hose. The more bends and the longer the hose, the less air will circulate through the machine, which will impede drying performance. Subtract 4 feet (120 cm) for every 90° elbow.

Installation Examples

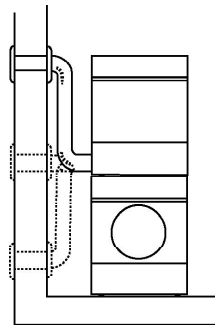

Subtract 4 feet (120 cm) for every 90° elbow.

NOTE: When installing in warm climates (77°F and above) with high humidity levels, do not route the air exhaust hose upwards.

If more than 22 feet of hose is needed, the diameter must be increased to 6" or 8" (152 mm or 203 mm).

WARNING! This appliance should not be exhausted into a chimney, a wall, a ceiling, or a concealed space of a building. Only a metal ventilation grill should be used.

If the hose is taken to a wall outlet, a ventilation grill should be fitted to prevent reverse flow of cold air. Fit the ventilation grill to the outside or inside of the wall.

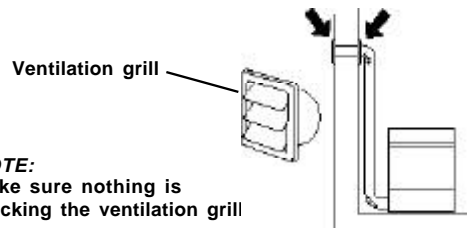

If there is only one vent duct from the room, a vent spacer must be fitted.

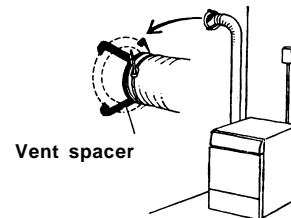

FREESTANDING INSTALLATION

The dryer can be placed next to the washing machine. It is essential that the machine is leveled and the locknuts are tight to eliminate vibration.

There should be at least 1/2" (12.5 mm) of space between the washer and dryer.

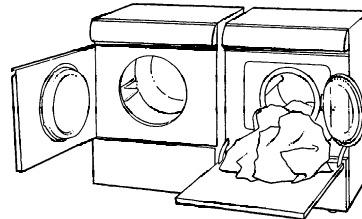

BUILT-IN INSTALLATION

MODELS T700/T760

These models can be installed beneath a cabinet or worktop with a minimum height of 34" (864 mm). There must be a gap of about 1/4" (.64 mm) all around the machine, including between the rear edge of the machine top panel and the back wall. The opening width must be at least 24" (600 mm).

Space must also be available for the exhaust hose on the left, right or rear of the machine. See the diagram for hole sizes and positions. Note that the hole measurements are to the center of the hole.

MODELS T720/T780

The condensing models work best when they have good air circulation. Therefore, we don't recommend that they be installed beneath a cabinet. If it is necessary, however, be sure to leave a gap of at least 1/2" on all sides.

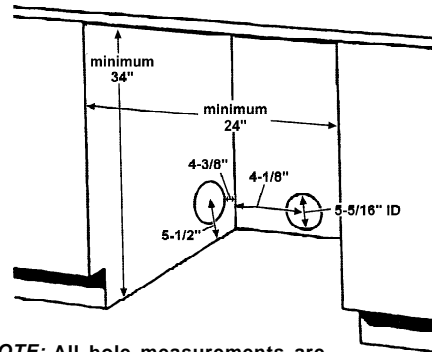

NOTE: All hole measurements are to the center of the holes.

NOTE: The height adjustment for the dryer is 33-1/2" to 34-1/2" (850 mm to 876 mm). Do not raise it higher than 34-1/2".

ELECTRICAL CONNECTIONS

The power supply cord must be grounded. If the machine is to be used in a wet area, the supply must be protected by a residual current device.

NOTE: In Canada, the dryer is delivered ready-fitted with a four-prong plug intended for connection to a single-phase supply.

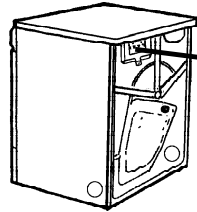

Remove cover to access terminal box. (Requires a 20-Torx screwdriver.)

Connection to a permanently wired supply point must be made only by a qualified electrician.

As supplied: Single-phase, 230 V, 60 Hz,
2500 Watt heater rating
30 A fuse required

CAUTION:

The receptacle on the rear of the machine is designed to accommodate ASKO washers **ONLY** (rated 208–240 V.) To use this receptacle, you must use the ready-fitted plug supplied with the washing machine or an equivalent. The supply connection must be 208–240 V, 20 A.

ASKO washers rated 208–240 V have two internal fuses of 15 A each.

Connecting a Three-wire Power Cord

WARNING! Before starting this procedure, be sure the power is turned off at the breaker/fuse box.

Power Supply Cord

You will need a three-wire power supply cord with three No. 10 copper wires and a matching three-wire receptacle of NEMA Type 10-30R, as illustrated below:

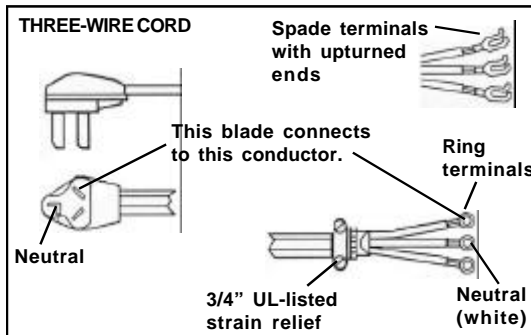

1. Turn the power off at the breaker/fuse box.
2. Remove terminal block cover.
3. Use the strain relief attached below the terminal block opening.
4. Loosen or remove center terminal block screw.
5. Connect neutral wire (white) of power supply cord to the center, silver-colored terminal screw. Tighten screw.
6. Connect the other wires to outer screws.
7. Tighten the strain relief screws.
8. Replace terminal box cover on back of dryer.
9. Plug dryer into wall receptacle.
10. Turn power on at breaker/fuse box.

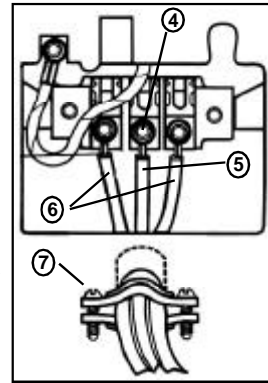

Connecting a Four-wire Power Cord

WARNING! Before starting this procedure, be sure the power is turned off at the breaker/fuse box.

Power Supply Cord

You will need a four-wire power supply cord with four No. 10 copper wires and a matching four-wire receptacle of NEMA Type 14-30R, as illustrated below. The fourth wire must be identified with a green cover and the neutral conductor by a white cover.

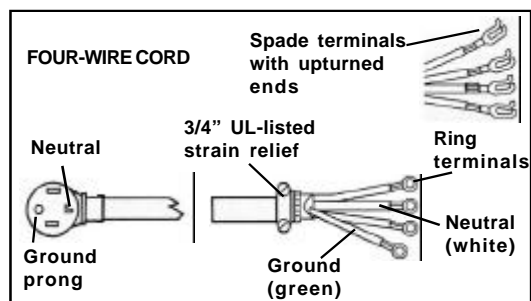

1. Turn the power off at the breaker/fuse box.
2. Remove terminal block cover.
3. Use the strain relief attached below the terminal block opening.
4. Remove center terminal block screw.
5. Remove ground wire (green with yellow stripes) from external ground connector screw. Fasten under center, silver-colored terminal block screw.
6. Connect ground wire (green) of cord to external ground conductor screw.
7. Connect neutral wire (white) of cord under center screw of terminal block.
8. Connect the other wires to outer screws.
9. Tighten the strain relief screws.
10. Replace terminal box cover on back of dryer.
11. Plug dryer into wall receptacle.
12. Turn power on at breaker/fuse box.

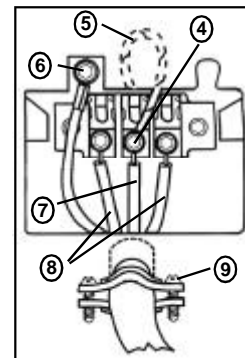

STACKED INSTALLATION

ASKO dryers can be mounted on top of any matching ASKO washer. Mounts are supplied with the machine.

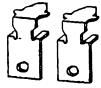

Two metal brackets for securing the dryer to the washer

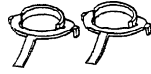

Two plastic cups to secure the dryer legs.

To install the dryer on top of the washer, follow the steps below:

1. Remove the two outside screws (20 torx) from the back of the washer and use them to secure the metal brackets, as illustrated.

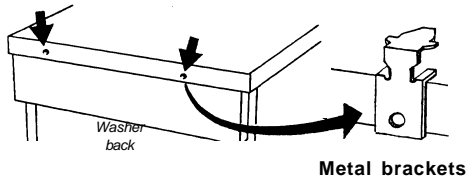

Metal brackets

2. To ensure the dryer is correctly positioned on top of the washer, align the plastic cups with the front edge of the washer.

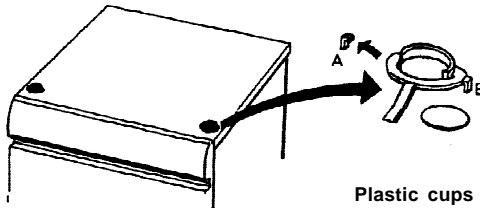

Plastic cups

To position the plastic cups, break off the left tab (A) on the cup to be placed on the right side of the washer and break off the right tab (B) on the cup to be placed on the left side of the washer.

3. Remove the protective paper from the self-adhesive surface beneath the cups. Being careful not to press the adhesive surface against the top of the washing machine, use the tabs to position the cups (as illustrated) then press them firmly into place.

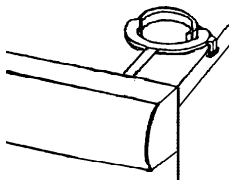

4. Once the cups are in place, break off the remaining plastic tabs.

5. Lift the dryer into position. Raising the front edge, push the dryer backwards until it engages with the brackets on the back of the washer.

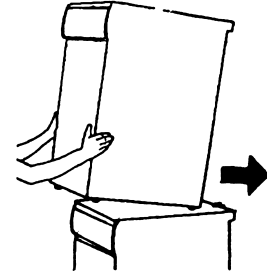

6. Carefully lower the front of the dryer, making sure the feet fit into the plastic cups.

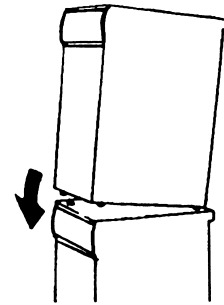

Stacked Installation

Tumble dryer

Washer

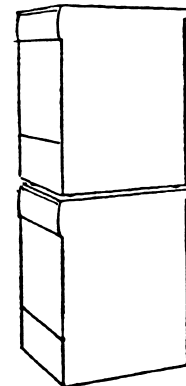

Total height 67".
Adjustable to 69".

WARNING!
Never stack a washer on top of a dryer!

REVERSING THE DOOR HINGES

The door hinges on ASKO dryers are reversible. The dryers are shipped left-hinged. To reverse them, follow the steps below:

WARNING! Switch off the main power supply before you start this procedure.

1. Remove the two 20 torx screws on the bottom of the front panel then grasp the bottom of the panel and pull it forward and down. 

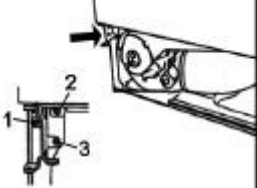
2. Remove the three screws holding the hinge. 

3. Supporting the door from the bottom, pull it out and to the left as you turn the hinge counter clockwise. 

4. Remove the top hinge pin then turn the hinge upside down and put the hinge pin into the top hole. 

5. Repeat steps 1–4 for the bottom hinge.

6. Loosen the two screws on both sides of the door so you can remove the magnetic door latch and the cover plate.

7. Remove the door latch by pushing it up then lifting it out from the bottom. 

8. Remove the cover plate by pushing it down then lifting it out from the top. 

9. Reverse steps 6 and 7 to place the door latch and cover plate into their new positions.

10. Tighten the screws on the sides of the doors to hold the latch and cover plate in place.

11. Using a flathead screwdriver, remove the plastic plugs in the upper and lower edge of the door and place them in the empty holes on the opposite side. 

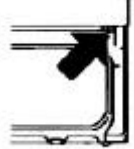
12. Remove the screw in the top right corner of the front panel, as indicated in the illustration. (If you have a condenser dryer, you will need to open the condenser container door.) 

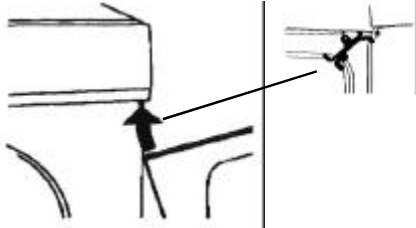
13. Now you are ready to mount the door on the right side. Holding the door at an angle (as illustrated), fit the hinge pin into the top hole. 

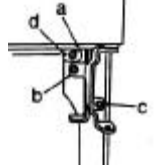
14. Tighten the screws in the order illustrated at right (a, b, c). 

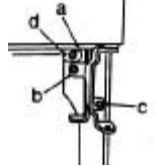
15. Replace the screw you removed in step 12 (d). 

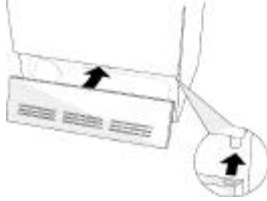
16. Close the condenser container door and replace the front panel. 

17. Turn back on the main power.

ASKO PRODUCT WARRANTY

MODELS T700, T720, T760, T780

Be sure to complete the Warranty Registration Card you received with your appliance and mail it to ASKO to validate your appliance warranty.

FOR RESIDENTIAL INSTALLATIONS ONLY

<i>LENGTH OF WARRANTY</i>	<i>ASKO WILL PAY FOR:</i>
<i>Three-Year Full Warranty</i> From date of purchase.	ASKO replacement parts and/or repair labor to correct defect in materials or workmanship. Service must be provided by an authorized ASKO service agent.
<i>Fourth & Fifth Year Limited Warranty</i> Three year full plus fourth and fifth year limited from date of purchase.	ASKO replacement parts for any defective solid-state controls, timers, motors, or pumps.
<i>Lifetime Warranty</i>	ASKO will replace the stainless steel inner or outer drum if it rusts or fails to hold water.

ENGLISH

ASKO WILL NOT PAY FOR:

- A. Service calls to:
 - 1. Correct the installation of the appliance.
 - 2. Repair damage due to shipment, delivery, installation, misuse or abuse.
 - 3. Instruct how to use the appliance.
 - 4. Replace house fuses or correct house wiring.
 - 5. Correct house plumbing, including drain problems related to improper installation.
 - 6. Clean or service air device in drain line.
- B. Repair and/or replacement parts for failure of product if appliance is used for other than home/residential use.
- C. Damage resulting from accident, fire, floods, acts of God, alteration, misuse, abuse, improper installation, or installation not in accordance with local electrical or plumbing codes.
- D. Any shipping costs for parts during the limited warranty period.
- E. Replacement parts or repair labor costs for units operated outside the Continental United States.
- F. Pickup and delivery. ASKO washers are designed to be repaired in the home.

IN NO EVENT SHALL ASKO USA INC. BE RESPONSIBLE FOR ANY INCIDENTAL OR CONSEQUENTIAL DAMAGES.

Some states will not allow the exclusion or limitation of incidental or consequential damages, so this exclusion or limitation may not apply to you. This warranty gives you specific legal rights and you may also have other rights which vary from state to state.

For warranty service, contact the dealer from whom you purchased the unit or an authorized ASKO service agent. Service will be provided during normal business hours. Should you have a service problem that can not be resolved locally, write:

ASKO USA Inc.
P. O. Box 851805
Richardson, Texas 75085-1805

or call our
Customer Service Center at
800-898-1879 or 972-238-0794

INDEX

A		Load sizes, recommended	4
Advisory Center phone number	15	M	
Air exhaust, connecting	10	Maintenance instructions	4
Air fluff, programming	8	Magnetic door lock	2
Automatic door switch	2	Menus, programming	8
B		O	
Built-in installation	11	Options menu	8
C		Overflow error message	9
Care and cleaning	4	Overheat protection	2, 6
Care label instructions	3	P	
Changing the LED readouts	9	Power cord connection	12
Child-safe start (T760/T780)	2, 9	Preset programs	7
Child-safe temperature knob	2	restoring	9
Condensation container, emptying	4	Problems, solving	6
Condensation drain connection	10	Program menu	7, 8
Condenser, cleaning	5	Program options	7
Control panel, cleaning	4	R	
Cosmetic damage	10	Restoring a preset program	9
Customizing the preset programs	7	S	
D		Safety features	2
Delayed start, programming	9	Safety instructions	2
Door, cleaning	4	Sensidry	3
Door hinges, reversing	14	Sensor error message	9
Door switch	2	Service	15
Dryer features	3	Solutions to problems	6
Drying problems	3, 6	Sorting the laundry	3
Drying times	3	Specifications	10
E		T	
Electrical connections	12	Temperature menu	8
Error messages (T760/T780)	9	Temperature settings	4
Exhaust hose, cleaning	4	Thermostat Control	3
F		Thermistor error message	9
Fabric softener sheets	3	Three hours error message	9
Fabric types	4	Timed dry, programming	8
Fan, cleaning	5	Timer control	3
Freestanding installation	11	Troubleshooting	6
H		V	
Hazardous materials	2	Ventilation duct connection	11
I		W	
Installation instructions	10–14	Warranty information	15
L		Wash programs	7
Languages, changing the LED	9	Water container, emptying	4
Lint filter	4		