

This Owner's Manual is provided and hosted by [Appliance Factory Parts](#).

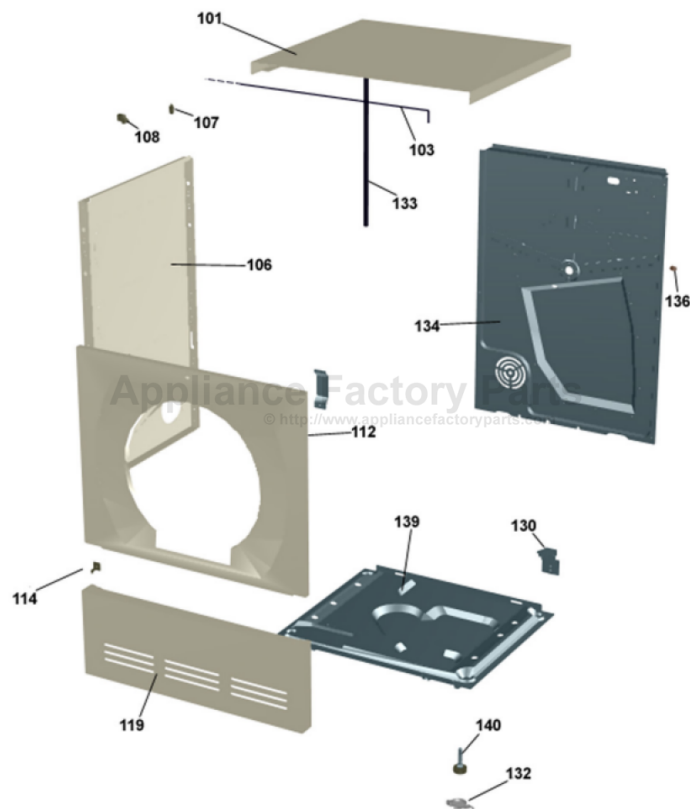

# ASKO T780 Owner's Manual

[Shop genuine replacement parts for ASKO T780](#)



[Find Your ASKO Dryer Parts - Select From 74 Models](#)

----- Manual continues below -----

# Tumble dryer ASKO T780

## DEAR ASKO CUSTOMER

Welcome to the family of ASKO customers. We hope that you will get many years of good use of your new tumble dryer. The tumble dryer is very sophisticated. In order to get best possible use of your machine and all its functions we recommend you to read this Use and Care Guide before you use the tumble dryer.

# CONTENTS

---

## READ FIRST

- 1 Before tumble drying the first time** 3
- 2 Safety instructions** 4  
General. Installation. Safety. Interrupting a program. Transport/Winter storage. Packing material. Disposal.
- 3 Children's safety** 5  
General. General. Child lock on Start and Menu buttons.
- 4 Parts of the dryer** 7
- 5 Panel** 8
- 6 LC Display** 8

## INSTALLATION

See instructions for installation.

## TUMBLE DRYING

- 7 Before tumble drying** 9-11  
Spin-dried? Recommended washing marking. Sorting. Programs. Options. Temperature. Drying time.
- 8 Tumble dry** 12-15  
Main power switch. Open the door. Selecting program. Temporary alterations. Start tumble drying. Putting in more washing. Changing the program. After tumble drying. Cleaning the lint filter. Emptying the condensation water container. Hint.

- 9 Consumption values - Pre-set drying programs** 16

- 10 Making own drying programs** 17-21  
Select initial program. Programs. Options. Temperature. Delayed start. Short cuts. Restoring pre-set program.

## CARE

- 11 Care - Cleaning** 22-25  
Cleaning the lint filter. Emptying the condensation water container. Cleaning the outside of the machine. Cleaning the fan. Cleaning the condenser.

## PROBLEMS?

- 12 Trouble shooting** 26-27  
Machine will not start. Overheating protection. No interior lighting. Drying takes too long. Fault indications. Wrong language on the display.

## MISCELLANEOUS

- 13 Technical information** 28  
Technical data. Standard tests.
- 14 Service and guarantee** 29
- 15 Quick guide** 30
- 16 Index** 31

# 1 BEFORE TUMBLE DRYING THE FIRST TIME

---

## **READ THE OPERATING INSTRUCTIONS**

Please read through this Use and Care Guide before attempting to use the machine, particularly Chapter 2, Safety instructions, and 3, Children's safety.

## **DO NOT TUMBLE-DRY**

Some fabrics are sensitive to tumble drying. Check the Recommended washing marking on the items concerned, and study Chapter 7, Before tumble drying.

## **NOTE.**

When you start the tumble dryer the first time, or after a long period when it has not been in use, you may hear a light rumbling noise. This is quite normal and the sound will disappear after a few drying operations.

## 2 SAFETY INSTRUCTIONS



### GENERAL

- Study and save this Use and Care Guide for future reference.
- Electrical installation, if required, must be carried out by an authorized electrician.
- The machine may only be used for tumble drying in accordance with this Use and Care Guide.

### INSTALLATION

See the accompanying installation instructions.



### SAFETY

This machine may not be used for drying fabrics that have been dry-cleaned at home, or which can be suspected of containing residues of flammable fluids.

The tumble dryer is fitted with an overheating protection device, which switches the machine off in the event of excessive temperature.

A float valve switches the machine off if the condensation water hose becomes clogged, or if there is danger of water flowing over from the container.

### INTERRUPTING THE PROGRAM

A drying program can be interrupted by pressing the main switch, , or by opening the door causing the drum to stop automatically. The machine will “remember” where in the program it was when stopped. If you wish to continue the drying process, just close the door and press the -button and the machine will start where it was interrupted.

You can also interrupt a program by pressing

 for three seconds. However, if you stop the machine in this way it will forget where it was in the program and you will have to select a program to restart.

### TRANSPORT/WINTER STORAGE

If the machine is to be transported or stored during the winter, on unheated premises, ensure that the water container is drained.

### PACKING MATERIAL

Sort the packing material for recycling according to recommendations by the local authorities.

### DISPOSAL

When the machine is no longer useful and is to be scrapped it should be made unusable.

Get in touch with the refuse collection service or your local authorities for advice on how to scrap the machine in a proper manner.

The machine is made and marked to facilitate recycling.

## 3 CHILDREN'S SAFETY





### GENERAL

Do not allow children to play with the tumble dryer.



The tumble dryer is fitted with a magnetic catch, which allows the door to be opened from the inside. The door is equipped with a switch, which automatically stops the tumble dryer when the door is opened. The machine will not start automatically on closing the door (eg, if a child should close the door from the inside).



### CHILD LOCK ON AND BUTTONS

By locking the  and  buttons, you can prevent that for example a child starts the machine or changes the settings by mistake.

### Child lock On/Off

Turn the main power switch, , off and then turn it on again.



Press the  button five times, then press the  button five times. These ten times must be completed within fifteen seconds.

Within three seconds after the last press on the  button, use the   buttons to choose Child lock ON (the figure 3 will appear at the bottom right in the display) or OFF (the figure 0 will appear at the bottom right in the display).

**To start a program with locked  button.**

Press the  button for three seconds and the machine will start.

**To change program settings with Child locked  button.**

Press the  button for three seconds, after that the  button works normally again. If you do not press any button within two minutes, the  button will be locked again.

DELIBERATELY BLANK PAGE

# 4 PARTS OF THE TUMBLE DRYER

---

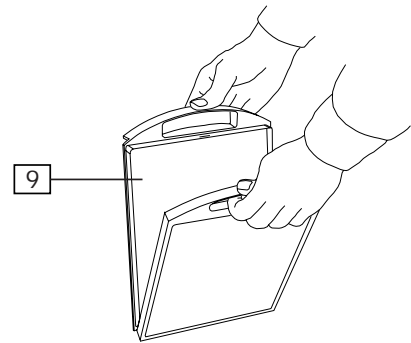
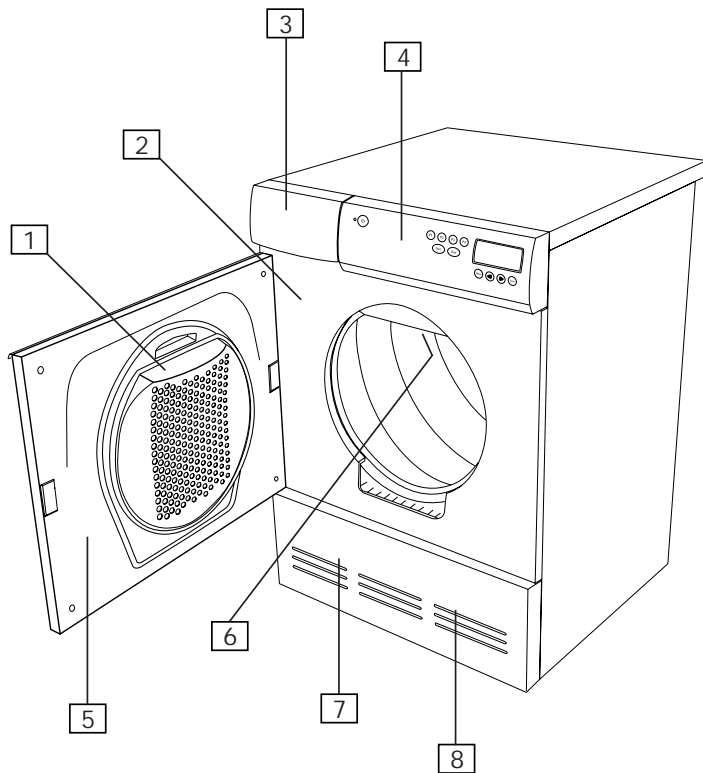

---

1. FLUFF-FILTER HOLDER

---

2. DATA PLATE

---

3. CONDENSATION WATER CONTAINER

---

4. PANEL

---

5. OUTER DOOR

---

6. INTERIOR LIGHTING (ON THE INSIDE)

---

7. FAN (BEHIND THE LOWER COVER)

---

8. CONDENSER (BEHIND THE LOWER COVER)

---

9. LINT FILTER

---

## 5 PANEL

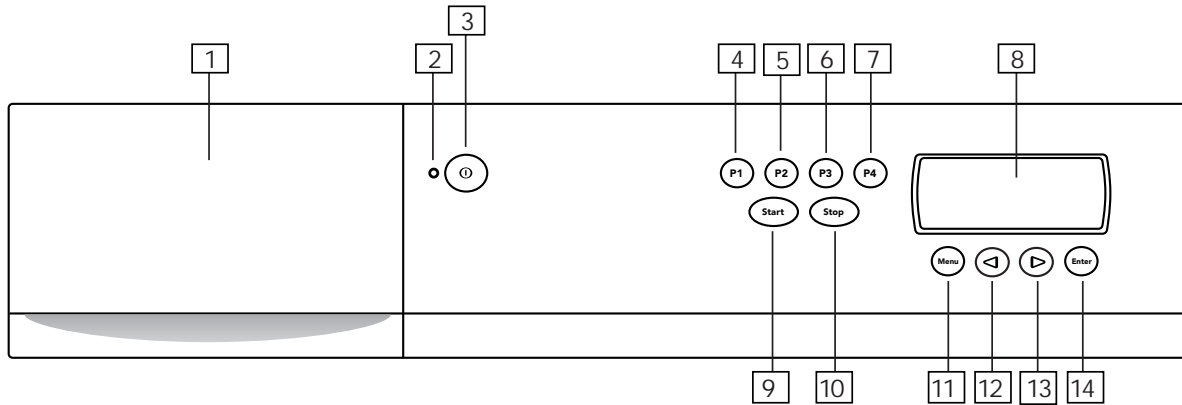

1. CONDENSATION WATER CONTAINER

2. INDICATION LAMP ON/OFF

3. MAIN POWER SWITCH

4. PROGRAM SELECTION BUTTON P1

5. PROGRAM SELECTION BUTTON P2

6. PROGRAM SELECTION BUTTON P3

7. PROGRAM SELECTION BUTTON P4

8. LC DISPLAY

9. START BUTTON

10. STOP BUTTON

11. MENU BUTTON

12. STEP BACKWARD

13. STEP FORWARD

14. ENTER BUTTON

## 6 LC-DISPLAY

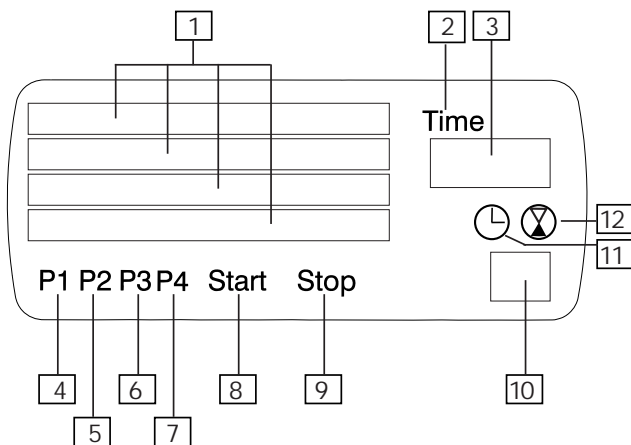

1. TEXT FIELD, SHOWING PROGRAM, OPTIONS, ERROR MESSAGES, ETC.

2. INDICATES THAT [3] SHOWS SELECTED DURATION FOR A TIMED DRY PROGRAM

3. SHOWS SELECTED DURATION FOR THE TIMED

PROGRAM

4. INDICATES THAT SELECTED PROGRAM IS P1

5. INDICATES THAT SELECTED PROGRAM IS P2

6. INDICATES THAT SELECTED PROGRAM IS P3

7. INDICATES THAT SELECTED PROGRAM IS P4

8. INDICATES THAT A PROGRAM IS STARTED

9. INDICATES THAT A PROGRAM IS COMPLETED OR STOPPED

10. SHOWS TOGETHER WITH [11] NUMBER OF HOURS FOR DELAYED START TIME AND TOGETHER WITH [12] REMAINING PROGRAM TIME

11. INDICATES THAT [10] SHOWS DELAYED START TIME

12. INDICATES THAT [10] SHOWS REMAINING PROGRAM TIME

# 7 BEFORE TUMBLE DRYING

---

Before you start tumble drying, here is some advice that can be useful.

## SPIN-DRIED?

Items that are to be tumble dried should first be spin-dried, preferably at 800 revs per minute or more. Better spin drying saves both energy and drying time.

## RECOMMENDED WASHING MARKING

 **Material suitable for tumble drying**

The symbol above indicates that the material can be tumble-dried. Cotton fabrics, towelling and synthetic fibres are best suited to tumble drying. Clothes and fabrics become softer and fluffier when tumble-dried than when dried on a line.

### NOTE

Wear and tear of fabrics in a tumble dryer is minimal. The lint caught in the lint filter consists of dust and fibre residue that has been formed when wearing the garments.

 **Material which should not be tumble-dried**

This symbol indicates that the material will not

TYPE OF FABRIC		LOAD	TEMPERATURE
White, coloured and synthetic	Cotton and linen	1/1 (5.0 kg)	Normal
	Polyester/cotton	1/2 (2.5 kg)	Normal
Delicate and mild	Acrylic, rayon, acetate etc.	1/2 (2.5 kg)	Low

Sort a suitable amount and type of fabric.

withstand tumble-drying.

Certain materials will melt or become dangerously flammable if heated, while others will lose their shape or shrink.

### Do not tumble-dry...

- Materials that are marked “Do not dry close to heat”.
- Items that have been dry-cleaned at home.
- Foam plastic.
- Glass-fibre materials
- Woollen items, because of the risk of felting.

## SORTING FABRICS

Best results are obtained if all articles are of the same material.

Close zip-fasteners, button up garments, tie belts, and sort the fabrics and adapt the load and the temperature as shown in the table below.

## PROGRAMS

### Extra dry

This program is designed for washing that is extremely difficult to dry, eg, jeans with very thick seams.

### NOTE

Knitted fabrics in particular are liable to shrink. Use the Dry, Normal dry or Iron dry program for these materials. Always stretch garments out directly after drying.





### **Dry, Normal dry**

These programs turn off the heat when the washing is dry, but not bone-dry.

The Dry program turns off the heat a little later than Normal dry. Choose what you prefer by trial and error. Use these programs when you want dry fabrics.

### **Iron dry**

This program turns off the heat when the washing is just damp enough for ironing or mangling.

### **Timed dry program**

The program length that you should choose depends on what you wish to do with the fabrics after tumble drying. Dry different times for different materials to find the right combination.

When using a timed dry program with mixed washing it may happen that some of the items will not be sufficiently dried. Such items can suitably be dried by running the timed program for a further 10 minutes or so.

Timed dry programs automatically operates at temperature Low, but you can change it yourself to Normal.

### **NOTE**

When using a timed program it is possible to over-dry fabrics if you set too long a time. This can cause fabrics to shrink or crease and feel rough. Synthetic materials can also become charged with static electricity. Set a shorter time if you tumble dry at temperature Normal.

### **Air fluff program**

Use the air fluff program just to shake dust out of garments, air them or soften them up.

To select Timed dry program or Air fluff program, see Chapter 10, Making own drying programs.

### **OPTIONS**

#### **Cooling**

You can choose between Normal cooling and Quick cooling. Normal cooling lasts 20 minutes and Quick cooling lasts 15 minutes.

#### **Buzzer**

The machine offers you the possibility of hearing when the cooling period ends. Set the option Buzzer ON and it will sound for three seconds when the program is completed.

### **Anti-crease program**

Using the Anti-crease program you can prevent garments from lying still and becoming unnecessarily creased at the end of tumble drying. This is a helpful option if you cannot take out garments promptly at the end of the tumbling phase.

You can choose a program duration of 1, 2 or 3 hours. The drum will then continue to rotate intermittently, ie, three seconds every minute for the number of hours chosen.

If you choose Buzzer ON, a signal will sound each time the drum rotates.

To choose these options, see Chapter 10, Making own drying programs.



## TEMPERATURE

You can choose temperature Normal or Low, see chapter 10, Making own drying programs.

## DRYING TIME

Drying time depends on many factors, such as the amount of washing, how damp it is, the type of fabrics, rated power of the machine and the temperature and humidity of the input air. It also depends, naturally, on how dry you want the washing to be when you take it out of the machine.

The remaining drying time is approximately calculated within four minutes after the program is started. It shows, together with the -symbol, at the bottom right in the display.

# 8 TUMBLE DRY

## PRESS THE -BUTTON

The display will then show the four pre-set programs. If no button is pressed within three minutes the display will go out. The display will light again when one of the buttons is pressed.

If the language on the display is wrong for any reason, it can be restored to the right language again. See chapter 12, Trouble shooting.

## OPEN THE DOOR

Put the fabrics in, sorted according to the instructions in Chapter 7, Before tumble drying. Close the door.





## SELECT A PROGRAM

Choose one of the pre-set programs  to .

## Pre-set drying programs

The machine has four pre-set drying programs, these are:



 - Extra dry. Normal temperature, Normal cooling, Buzzer ON, and Anti-crease program for 1 hour.

 - Dry. Normal temperature, Normal cooling, Buzzer ON, and Anti-crease program for 1 hour.

 - Normal dry. Normal temperature, Normal cooling, Buzzer ON, and Anti-crease program for 1 hour.

 - Iron dry. Normal temperature, Normal cooling, Buzzer ON, and Anti-crease program for 1 hour.





## TEMPORARY ALTERATIONS

If you have made your own drying program and included in it a Timed dry program or Air fluff program, you can easily alter the program time. To do this, use the   -buttons as described below. These alterations return to the initial settings at the end of the drying program (to select Timed dry program or Air fluff program, see chapter 10, Making own drying programs).

To alter other settings in the programs, see chapter 10, Making own drying programs.

## Timed dry program

To set the desired time for the program, use the

  buttons. The  button reduces the time and the  button increases the time. Step up or down to the desired time. The time is then shown in the upper right corner together with the Time symbol.

PROGRAM BUTTON	PROGRAM	OPTIONS			TEMPERATURE	DELAYED START
		Cooling	Buzzer	Anti-crease program		
P1	EXTRA DRY	NORMAL	ON	ON, 1 h	NORMAL	0 h
P2	DRY	NORMAL	ON	ON, 1 h	NORMAL	0 h
P3	NORMAL DRY	NORMAL	ON	ON, 1 h	NORMAL	0 h
P4	IRON DRY	NORMAL	ON	ON, 1 h	NORMAL	0 h

Settings of the four pre-set programs.

## START TUMBLE DRYING

Press the **Start** button.

The text **Start** at the lower edge of the display indicates that the program has started. The text field of the display shows the current stage of the program while it is in progress.

The remaining drying time is approximately calculated within four minutes after the program is started. It shows, together with the  symbol, at the bottom right in the display.

## PUTTING IN MORE WASHING

Open the door and the drum will stop automatically. To restart: Close the door and press the **Start** button.



## CHANGING THE PROGRAM

Press the **Stop** button for three seconds. The program will then be zero set and you can choose a new program.

## AFTER TUMBLE DRYING

- Turn off the main switch.
- Clean the lint filter after each drying operation, see below. An error message will be displayed if the lint filter needs to be cleaned.
- Empty the condensation water container.

## WARNING!



If the lint filter becomes completely clogged the overheat protection device may trigger. The device must then be reset to enable the machine to be started, see Chapter 12, Trouble shooting.

## CLEANING THE LINT FILTER

1. Grasp the filter handle and pull towards you.

2. Pull the filter up out of the holder.

3. Open the filter and brush away the lint with your hand.

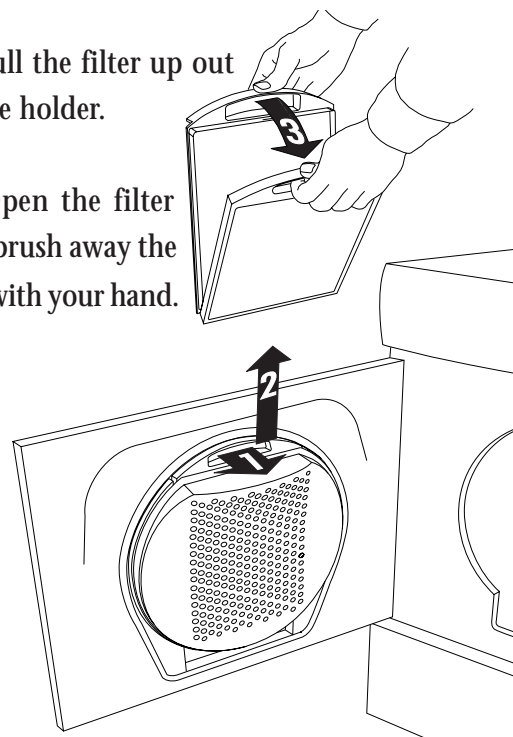

4. Fold the filter together and put it back in the filter holder.

## EMPTYING THE CONDENSATION WATER CONTAINER

Empty the condensation water container after each tumble drying.

Pull out the condensation water container, empty the water and put the container back.

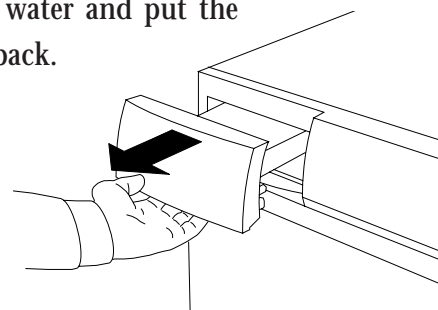

If the container becomes too full, the program will be interrupted and an error message





will be displayed in the text field. Empty the container and press the **Start** button and the program will continue from where it was interrupted, see also Chapter 12, Trouble shooting, heading Fault indications.

**NOTE**

---

Do not pull out the condensation water container while the machine is running.

**HINT**



---

The condensation water is soft, and is therefore suitable for use in a steam iron. Strain the water through a coffee paper filter before use.

If you want the water to be emptied automatically, see the Installation instructions.

DELIBERATELY BLANK PAGE

# 9 CONSUMPTION VALUES - PRE-SET DRYING PROGRAMS

The following conditions apply for the consumption values indicated below:

Temperature of intake air: 23 °C.

Humidity of intake air: 60 %.

Drying temperature: Normal (⊗), Low (⊗).

Element power: 1900 W, 240 V.

The cotton fabrics are, before tumble drying, spin-dried at 800 and 1600 rpm (long spin) with ASKO washing machine.

Other fabrics (creasfree and acrylics) are, before tumble drying, spin-dried at 800 rpm (short spin) with ASKO washing machine.

PROGRAM	WASHING	AMOUNT OF WASHING	ENERGY CONSUMPTION		PROGRAM TIME	
			( ca kWh)		(ca minutes)	
			800 rpm	- 1600 rpm	800 rpm	- 1600 rpm
P1 Extra dry	Cotton, linen, ⊗	1/1 (5.0 kg)	3.8	- 3.1	120	- 105
P2 Dry	Cotton, linen, ⊗	1/1 (5.0 kg)	3.5	- 2.8	110	- 95
	Crease free, polyester/cotton, ⊗	1/2 (2.5kg)	1.4	---	75	---
P3 Normal dry	Cotton, linen, ⊗	1/1 (5.0 kg)	3.2	- 2.4	95	- 80
	Crease free, polyester/cotton, ⊗	1/2 (2.5kg)	1.2	---	65	--
	Acrylics, rayon, acetate, ⊗	1/2 (2.5 kg)	1.5	---	75	---
P4 Iron dry	Cotton, linen, ⊗	1/1 (5.0 kg)	2.5	- 1.5	95	- 65

# 10 MAKING OWN DRYING PROGRAMS





You can make your own programs that perhaps suit your requirements better than the four pre-set programs.

It is always possible to restore the initial pre-set programs. See the heading at the end of this chapter, Restoring pre-set programs.

There is a flow chart on the next page that gives you a good overview of all the available functions.



After that follows a step-by-step instruction on how to design the programs that satisfy your requirements.

Each step begins with a description of the programs, options or settings that you can choose. Followed by a numbered sequence describing what to do to make the alterations that you require.

The buttons that you will need to use when compiling your own programs are , ,  and .

Step forward in the menu by pressing the  button to the menu heading where you wish to make an alteration. The menu headings

are: Programs, Options, Temperature and Delayed start. The options consist of sub-headings Cooling, Buzzer and Anti-crease program.

Using the   buttons, step forward or backward in the respective headings to the setting you wish to choose.

When you are at the desired setting, acknowledge your choice by pressing the  button once.

In order to remember what you have included in your drying programs, we recommend that you fill in the settings that you have chosen in the table noted on the last page of this chapter.

PROGRAM BUTTON	PROGRAM	OPTIONS			TEMPERATURE	DELAYED START
		Cooling	Buzzer	Anti-crease program		
P1	EXTRA DRY	NORMAL	ON	ON, 1 h	NORMAL	0 h
P2	DRY	NORMAL	ON	ON, 1 h	NORMAL	0 h
P3	NORMAL DRY	NORMAL	ON	ON, 1 h	NORMAL	0 h
P4	IRON DRY	NORMAL	ON	ON, 1 h	NORMAL	0 h

Settings of the four pre-set programs.





**USE THE , , , , -BUTTONS TO MAKE YOUR OWN PROGRAMS.**

Begin by pressing 



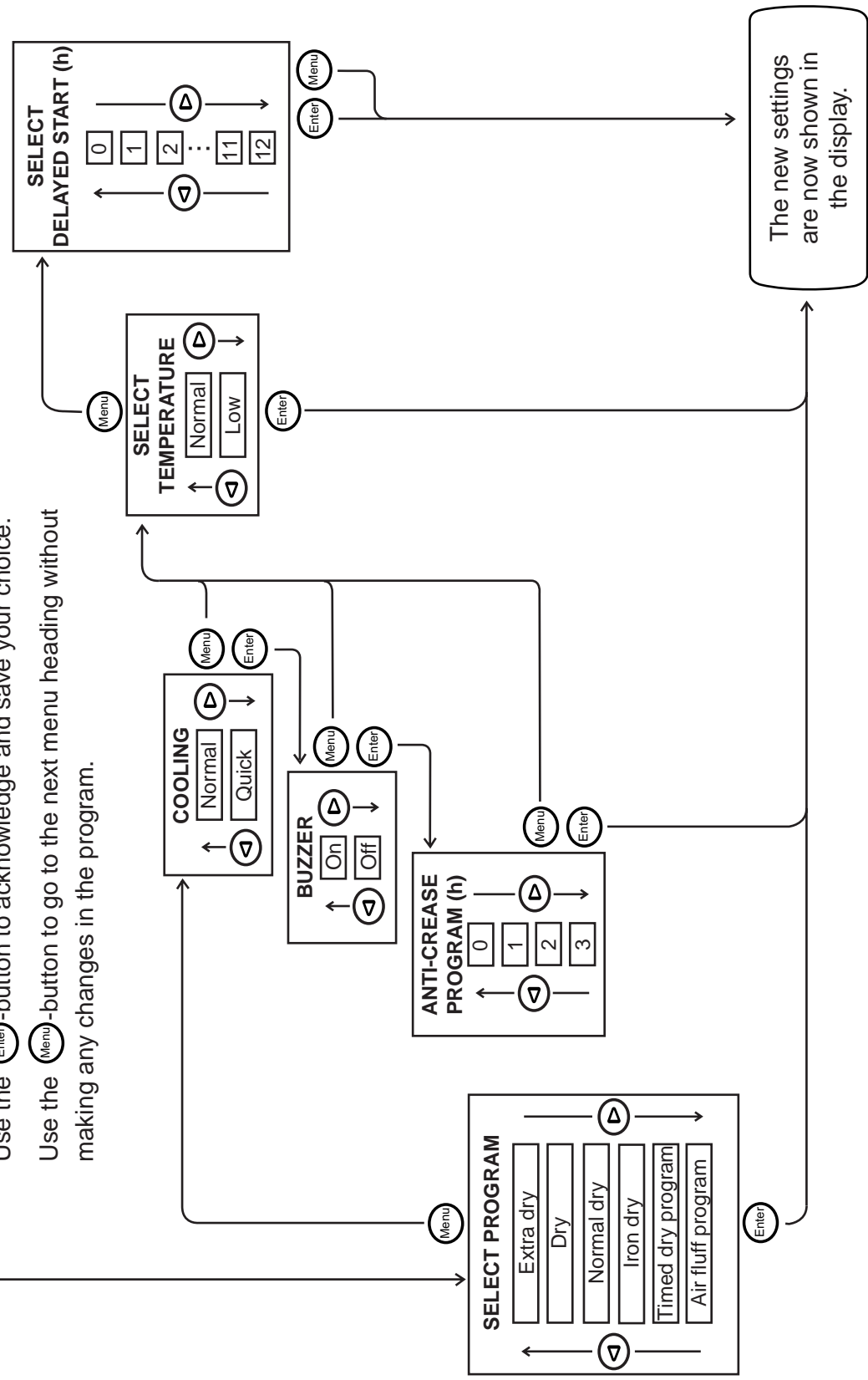

Use the -button to acknowledge and save your choice.

Use the -button to go to the next menu heading without making any changes in the program.



## 1 - SELECT INITIAL PROGRAM

Begin by choosing one of the pre-set drying programs.

1. Press the button of the program you wish to alter, ie, , ,  or .

## 2 - PROGRAMS

The programs that you can choose from are the following:

**Extra dry** - This program is for washing that is extremely difficult to dry, eg. jeans with very thick seams.

**Dry, Normal dry** - These programs turn off the heat when the washing is dry, but not bone-dry.

The Dry program turns off the heat a little later than Normal dry. Choose what you prefer by trial and error. Use these programs when you want dry fabrics.

**Iron dry** - This program turns off the heat when the washing is just damp enough for ironing or mangling.

**Timed dry program** - The program length that you should choose depends on what you wish to do with the fabrics after tumble drying. Dry different times for different materials to find the right combination.



### NOTE



When using a timed program it is possible to over-dry fabrics if you set too long a time. This can cause fabrics to shrink or crease and feel rough. Synthetic materials can also become charged with static electricity. Set a shorter time if you tumble dry at temperature Normal.

 **Air fluff program** - Use the Air fluff program just to shake dust out of garments, air

them or soften them up.

When you wish to run your Timed dry program or Air fluff program you can easily alter the program time, see heading Temporary alterations, in Chapter 8, Tumble dry.

1. Press the  button once.
2. With the   buttons select the desired program.

If you select Timed dry program or Air fluff program you should also choose how long you wish to run the program. After stepping to Timed dry program or Air fluff program, press the  button to choose the length of the program. Choose the desired time with the   buttons.





3. Press the  button once to acknowledge and save your choice.

## 3 - OPTIONS

This heading has three sub-headings (option headings) indicating the options that you can add to your program.

### Cooling



You can choose between Normal cooling and Quick cooling. Normal cooling lasts 20 minutes and Quick cooling lasts 15 minutes.

1. Press the  button once.
2. With the   buttons select Normal or Quick cooling.
3. Press the  button once to acknowledge and save your choice. You will now come automatically to sub-heading:



## Buzzer



If you choose Buzzer ON, a signal will sound for three seconds as the drying program ends.

1. With the   buttons select Buzzer ON or OFF.
2. Press the  button once to acknowledge and save your choice. You will now come automatically to sub-heading:

## Anti-crease program

In this program the drum will continue to rotate intermittently, ie, three seconds every minute at the end of the drying phase. You can choose a program duration of 1, 2 or 3 hours. The Anti-crease program prevents garments from lying still in the same position and becoming creased. This is a helpful option if you cannot take out garments promptly at the end of the tumbling phase.





If you have chosen Buzzer ON, a signal will sound each time the drum rotates during this program.

1. With the   buttons select how long you wish the Anti-crease program to run.
2. Press the  button once to acknowledge and save your choice.

You have now gone through all the options.

## 4 - TEMPERATURE

You can choose temperature Normal or Low.

1. Press the  button once.
2. With the   buttons select the desired temperature, Normal or Low.
3. Press the  button once to acknowledge and save your choice.





## 5 - DELAYED START

You can delay starting your drying program by up to 12 hours.

If you select Delayed start at say five hours, the machine will start five hours after you press the start button.

When you step forward to the desired time it will be shown together with the  symbol in the lower right corner of the display.

When you wish to run your drying program you can easily alter the time for Delayed start, see Temporary alterations, in Chapter 8, Tumble dry.

1. Press the  button once.
2. With the   buttons choose how long you wish starting of the drying program to be delayed.
3. Press the  button once to acknowledge and save your choice.



You have now compiled and saved your own drying program.

The next time you wish to run this particular program all you have to do is press the program button that you chose initially as the basis for your settings.

## SHORT CUTS

If you do not wish to make changes in all of the menu headings for your program you can simply jump past them.

To go to the next heading without making any changes, just press the  button once.

The basic settings under this heading will thus remain unchanged.

**NOTE**

This applies to menu headings. If you are in any of the option headings you will go to the next menu heading, ie, Temperature.



**RESTORING PRE-SET DRYING PROGRAMS**

You can always restore the four pre-set drying programs.

**Proceed as follows:**

1. Press the button of the program that you wish to restore and hold it pressed down.
2. Press the -button, without letting go of the program button.
3. Let go of both buttons and the pre-set program will now be restored.





# 11 CARE AND CLEANING

---

## CLEANING THE LINT FILTER

Clean the lint filter after each tumble drying operation.

If your water is very hard a deposit of lime may be formed on the filter. Check when cleaning lint from the filter if there is any sign of lime, if so wash the lint filter by hand to remove any deposits.

1. Grasp the filter handle and pull towards you.

2. Pull the filter up out of the holder.

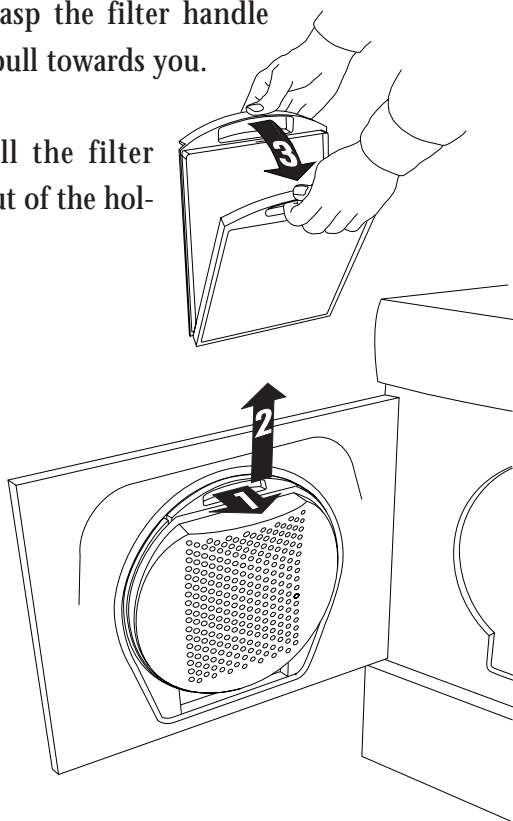

3. Open the filter and brush away the lint with your hand. Rinse the filter to remove any deposit of lime.

4. Fold the filter together and put it back in the filter holder.

## EMPTYING THE CONDENSATION WATER CONTAINER

Empty the condensation water container after each tumble drying.

Pull out the condensation water container, empty the water and put the container back.

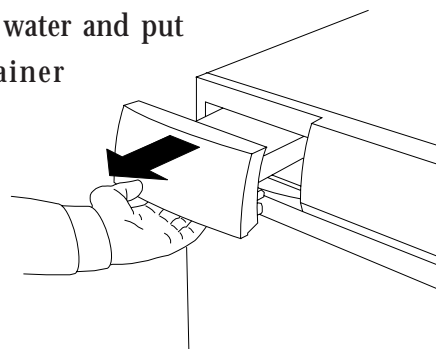

If the container becomes too full, the program will be interrupted and an error message will be displayed in the text field. Empty the container and press the **Start** button and the program will continue from where it was interrupted, see also Chapter 12, Trouble shooting, heading Error messages.

### NOTE

Do not pull out the condensation water container while the machine is running.

## CLEANING THE OUTSIDE OF THE MACHINE

Use a mild detergent to clean the outside of the machine. Do not use any solvents, they can damage the machine. Do not spray the machine with water.

### NOTE

Do not allow dust to accumulate round the machine. Keep clean and cool around the tumble dryer. Dust, heat and moisture prolong the drying time.



## CLEANING THE FAN

The fan should be cleaned at least once a year. If you have any household pets the fan must be cleaned more often.

1. Turn off the main power switch.
2. Remove the lower cover.

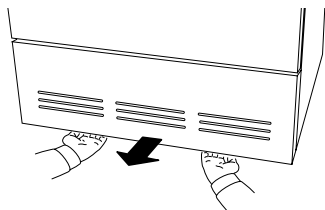

3. Unscrew the safety screw(1), fold out the four lugs(2) and take off the fan cover.

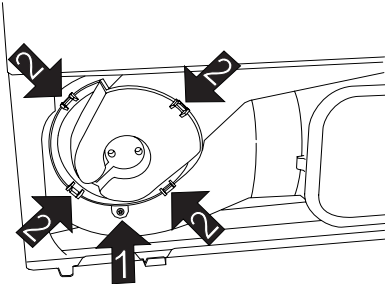

4. Unscrew the nut while holding the fan.

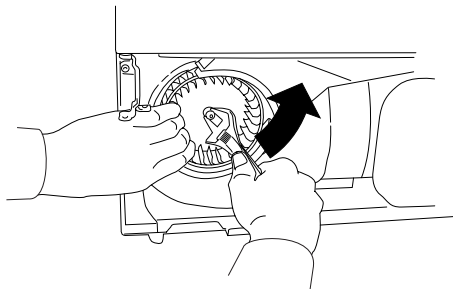

5. Take out the fan and clean it with a brush and water.

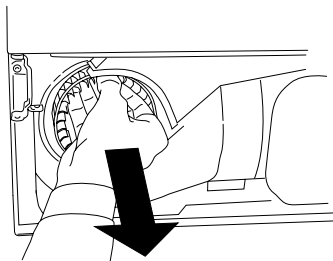

6. Put the fan back into place and screw on the nut.

7. Put the fan cover back into place and ensure that the lugs secure the cover in position. Screw the safety screw back.

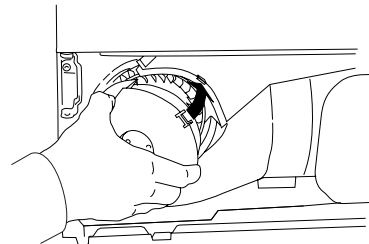

8. Fit the lower cover back in place.

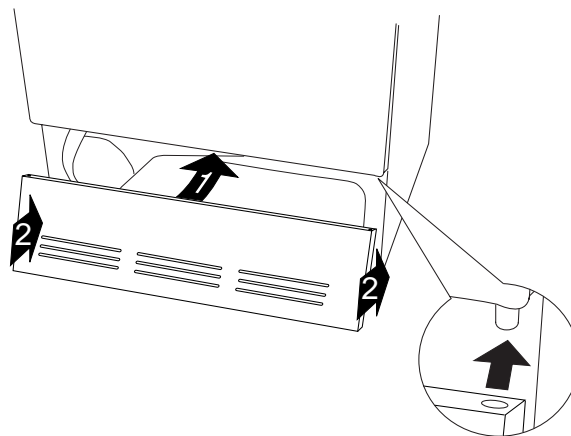

## CLEANING THE CONDENSER

The condenser should be cleaned at least three times a year. . If you have any household pets the condenser must be cleaned more often.

1. Turn off the main power switch.
2. Remove the lower cover.

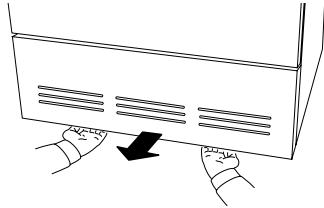

3. Turn the two levers anticlockwise to open the condenser cover.

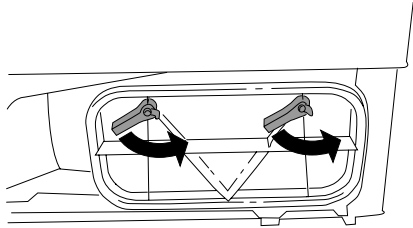

4. Take the condenser out and rinse the condenser fins clean, eg, using a hand-held shower.

Do not poke anything between the fins, you might damage the condenser. Do not use any sharp object when cleaning the fins.

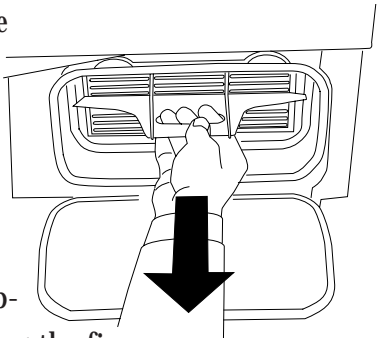

### NOTE

Do not attempt to clean the condenser in a dishwasher.

5. Refit the condenser, taking care to fit it the right way up.

The top of the condenser is marked “upp”, “up” and “oben”.

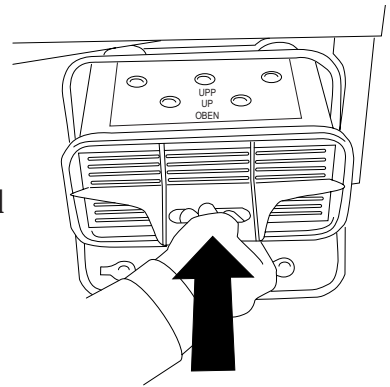

6. Fit the lower cover back in place.

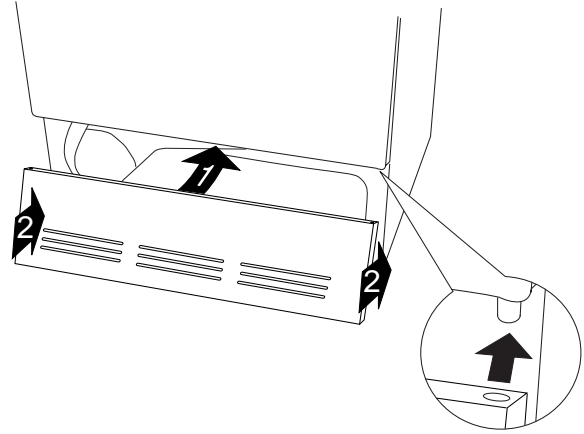

# 12 TROUBLE SHOOTING

---

## THE MACHINE WILL NOT START

Check that:

- The door is properly closed.
- The main switch is pressed in.
- You have correctly set the required program or the required time in the timed dry program.
- You have not chosen Delayed start.
- The electric plug, if any, is firmly inserted in its socket.
- All fuses are intact. Switch two fuses over. It is not always possible to see directly if a fuse has blown.
- The overheating device has not triggered, see below.

## OVERHEATING PROTECTION

The overheating protection device switches off the tumble dryer if the temperature becomes too high, eg, because the lint filter is clogged. If this happens, clean the filter, empty the water container and clean the condenser. Then reset the overheating device by pressing the rubber button on the back of the machine.

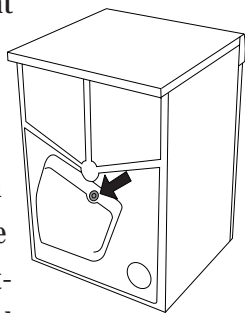

## NO INTERIOR LIGHTING

Check that:

- The main switch is pressed in.
- The electric plug, if any, is firmly inserted in its socket.
- All fuses are intact. Switch two fuses over. It is not always possible to see directly if a fuse has blown.
- The bulb is not burnt out. The lamp is located

at the top of the dryer just inside the door. Screw off the plastic cover protecting the bulb and screw out the bulb and replace it if it is faulty.

## EXCESSIVE DRYING TIME

Empty the water container and check that the lint filter and the condenser are not clogged, see Chapter 11, Care and Cleaning. Excessive drying times can also be caused by the machine being installed in a very confined space and by the air in the room (which cools the machine) becoming too warm. In this situation make sure that ventilation is improved, eg, by opening doors and/or windows.

## FAULT INDICATIONS

Error messages appear in the display text field if faults occur while a program is in progress. To exit the error messages after correcting the fault as described below, switch the machine off or change the program.

The error messages that can be displayed are:

**Maximum program time.** When the machine has run for its maximum time (three hours) it will stop. Ensure first that all fuses for the machine are intact. To exit the error message, switch the machine off or open the outer door. If this does not help, phone for service.

**Over flow.** Indicating that the condensation water container is overfilled. Empty the container and restart. If the message is repeated it may be because the lower water magazine is full, due to the pump or hoses being clogged or malfunctioning.

ning. If condensation water is pumped out direct to the drain, check to ensure there are no kinks or stoppage in the hose. If this does not help, phone for service.

**Sensor fault.** Fault in the moisture sensor. This error message can also appear if you should start the dryer when it contains dry items or when it is empty. To cancel the message, simply open the dryer door. If this does not work, phone for service.



**Thermistor fault.** Phone for service.



#### **WRONG LANGUAGE ON THE DISPLAY**

If the language on the display becomes altered for any reason, it can be restored to the initial language again.

The available languages are Dansk, Deutsch, English, Espanol, Français, Italiano, Nederlands, Norsk, Portugués, Suomi and Svenska.

Proceed as follows to change the language:

Turn the main power switch, , off and then turn it on again. Press the  button five times, then press the  button five times. These ten times must be completed within fifteen seconds.

Within three seconds after pressing  the last time, step to the desired language using the   buttons.

# 13 TECHNICAL INFORMATION

---

## TECHNICAL DATA

Height:	850 mm
Width:	595 mm
Depth:	585 mm
Weight:	47 kg
Drum volume:	111 litre
Drying capacity:	5.0 kg
Speed:	52 r/min
Rated power:	See data plate
Material: Cylinder and water container	Stainless steel
Material: Outer cover	Hot-galvanized, powder-lacquered steel or stainless steel
Positioning:	Washing tower, free-standing or built-in
Drain	2.0 polypropylene hose
Interior light:	10 W, plint E14.

## STANDARD TESTS

Australia:	AS/NZS 2442.1.
Drying performance and energy declaration:	Program 3, (Normal dry), 5.0 kg, cotton, temperature Normal.
Procedure for acoustic measurement:	IEC 704-2-6.

# 14 SERVICE AND GUARANTEE

---

## **SERVICE**

Before calling for service, check to see whether the fault is due to something that you can put right yourself. See chapter 12, Trouble shooting.

If you do require service, telephone your local ASKO retailer or the ASKO representative for your country. See guarantee card for address and telephone number.

## **GUARANTEE**

For guarantee details, see the guarantee card.



# 15 QUICK GUIDE



**1. Sort the washing.**

**2. Press the main switch ON,** .

Open the door and load the garments.

**3. Select a program.**

The machine has four pre-set drying programs  to , see table. Press the button for the desired program.

If you have made your own drying program and included in it a Timed dry program or Air fluff program, you can easily alter the program time. Use the  button to reduce the time and the  button to increase the time. Step up or down to the desired time.

**4. Close the door and press the  button.**

Close the door carefully, it should not be slammed.

**5. Drying program completed**

Open the door and take out the garments. The fluff filter should be cleaned and the water container emptied after each tumble drying operation.

**6. When tumble drying is completed.**

Press the main switch OFF, .

WASHING →	Coo <sup>l</sup> ton, linen etc		
		Polyester/cotton	Acrylics, rayon, acetates, (temperature sensitive materials)
Load (kg)	5.0	2.5	2.5
SET THE: Program	1 to 4 Extra dry, Dry Normal dry, Iron dry	2 or 3 Dry or Normal dry	2 or 3 Dry or Normal dry
Temperature	Normal	Normal	Low

# 16 INDEX

	Chapter		Chapter	Chapter
<b>A</b>		<b>F</b>		<b>Parts of the tumble dryer</b>
Acetate	7,15	Fault indications	12	Polyester
Acrylate	7,8,15	Felting	7	Power consumption
After tumble drying	8,15	Flammable material	2,7	Pre-set drying programs
Airing program	7,10	Foamed plastic	7	Program position
Altering settings	10			Programs
Anti-crease program	7,8,10	<b>G</b>		7,8,10,15
<b>B</b>		Glass-fibre material	7	<b>Q</b>
Before tumble drying the		Guarantee	14	Quick guide
first time	1			15
Before tumble drying	7	<b>I</b>		<b>R</b>
Belts	7	Installation, see Instructions for		Rayon
<b>C</b>		installation		7,15
Change program after starting	8	Interrupting the program	2	Recommended washing
Children's safety	3	Iron dry	7,8,10,15	marking
Child safety start	3	Ironing	7	Remaining drying time
Cold ironing	7			7
Coloured washing	7	<b>J</b>		Restoring pre-set program
Condensation water con-		Jeans	7	Restarting
tainer	8,11,12			8
Condenser	11,12	<b>K</b>		<b>S</b>
Cooling	7,8,10	Knitted fabrics	7	Safety
Cotton	7,15			2
Crease-free, see Anti-crease		<b>L</b>		Service
program		Language	12	14
<b>D</b>		LC Display	8	Signal
Delayed start	10	Linen	7,15	7,10
Delicate washing	7	Lint filter	8,11	Sorting textiles
Display, see LC Display		Low temperature	7,8,10	7
Disposal	2			Spin-dried
Do not tumble dry	7	<b>M</b>		7
Dry	7,8,10,15	Making own drying programs	10	Start
Dry cleaning	2,7			8,15
Drying time	7	<b>N</b>		Synthetic fabrics
<b>E</b>		Normal dry	7,8,10,15	7
Emergency stop, see Inter-		Normal temperature	7,8,10	<b>T</b>
rupting the program				Technical data
Error indications, see Fault indi-		<b>O</b>		13
cations		Options	7,10	Temperature
Extra dry	7,8,10,15	Overheating protection	2,12	7,8,10
		Own programs	10	Textile wear
				7
		<b>P</b>		Timed program
		Packing material	2	7,10
		Panel	5	Tumble dry
				8,15
				<b>W</b>
				Wool
				7
				<b>Z</b>
				Zip fastener
				7

