

This Owner's Manual is provided and hosted by [Appliance Factory Parts](#).

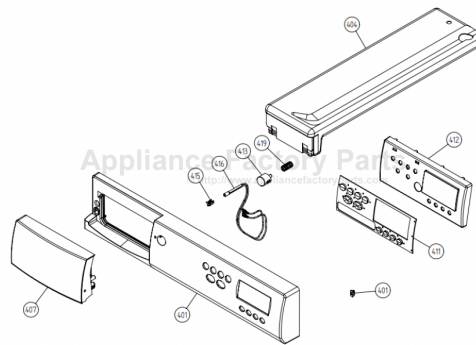

ASKO T781 Owner's Manual

[Shop genuine replacement parts for ASKO T781](#)



[Find Your ASKO Dryer Parts - Select From 74 Models](#)

----- Manual continues below part list -----

Available Replacement Parts for ASKO T781

[8065710](#)

BELT ASKO

Dear ASKO customer,

Thank you for choosing this Scandinavian quality product made in Vara, Sweden.

We want you to feel confident that the inside of your new machine is as good as the outside, and that the ethical and moral principles on which we built this machine are just as high as the quality and performance that you obtain from it. We hope that our machine will keep you happy for many years to come.

To derive the best possible benefit from your product, we recommend that you read this Use & Care Guide and the Installation Instructions before using the machine.

ASKO T781

CONTENTS

READ FIRST	Page
1 Before tumble drying for the first time	3
2 Safety instructions General, Installation, Safety, Interrupting a program, Transport/Winter storage, Packing materials, Disposal	4
3 Child safety General, Child lock	6
4 Parts of the tumble dryer	7
5 Panel	8
6 LC display	8

INSTALLATION

See Installation Instructions

TUMBLE DRYING

7 Before tumble drying Spin-dried?, Washing instructions, Sorting fabrics, Programs, Options, Temperature, Drying time	9-11
8 Tumble dry Tumble drying, Instructions – step-by-step, Automatic draining	12-15
9 Consumption values – pre-set drying programs	16
10 Making your own drying programs General, Available settings and options, Available programs, Create your own drying program, Interrupt input, Reset program, Menu system for altering pre-set programs	17-21

CARE	Page
11 Care and cleaning Cleaning the lint filter, Draining the condensation water container, Cleaning the outside of the dryer, Cleaning the fan, Cleaning the condenser	23-25

PROBLEMS?

12 Trouble shooting The dryer will not start, Overheating protection, No interior lighting, Drying takes too long, Fault messages, Wrong language on the display, Stop flashes in the display, Reset program	26-27
------------------------------------------------------------------------------------------------------------------------------------------------------------------------------------------------------------------------	-------

MISCELLANEOUS

13 Technical information Technical data, Standard tests	28
14 Service and guarantee	29
15 Quick guide	30
16 Index	31

1 BEFORE TUMBLE DRYING THE FIRST TIME

READ THE OPERATING INSTRUCTIONS

Please read through this Use and Care Guide before attempting to use the machine, particularly Chapter 2, Safety instructions, and 3, Children's safety.

DO NOT TUMBLE-DRY

Some fabrics are sensitive to tumble drying. Check the Recommended washing label on the items concerned, and study Chapter 7, Before tumble drying.

NOTE

When you start the tumble dryer the first time, or after a long period when it has not been in use, you may hear a light rumbling noise. This is quite normal and the sound will disappear after a few drying operations.

For brief operating instructions; see Chapter 15, Quick guide.

2 SAFETY INSTRUCTIONS



GENERAL

- Study and save this Use and Care Guide for future reference.
- Electrical installation, if required, must be carried out by an authorized electrician.
- The machine may only be used for tumble drying in accordance with this Use and Care Guide.
- Repairs and maintenance which affect safety or performance must be carried out by an authorized specialist.

INSTALLATION

See the accompanying installation instructions.

SAFETY

The tumble dryer is not to be used if industrial chemicals have been used for cleaning.

The tumble dryer is intended only for drying textile material washed in water.

The tumble dryer is fitted with an overheating protection device, which switches the machine off in the event of excessive temperature.

A float valve switches the machine off if the condensation water hose becomes clogged, or if there is danger of water overflowing from the container.

The appliance is not intended for use by young children or infirm persons without supervision

INTERRUPTING THE PROGRAM

A drying program can be interrupted by pressing the main switch, , or by opening the door causing the drum to stop automatically.

The machine will “remember” where in the program it was when stopped. If you wish to continue the drying process, just close the door and press the  -button and the machine will start where it was interrupted.

You can also interrupt a program by pressing  for three seconds. However, if you stop the machine in this way it will forget where it was in the program and you will have to select a program to restart.

TRANSPORT/WINTER STORAGE

If the machine is to be transported or stored during the winter, on unheated premises, ensure that the water container is drained.

PACKING MATERIAL

Sort the packing material for recycling according to recommendations by the local authorities.

DISPOSAL

Contact your local refuse collection service or your local authorities for advice on how to scrap the machine in a proper manner.

The machine is made and marked to facilitate recycling.

2 SAFETY INSTRUCTIONS



To minimize the risk of fire in a tumble dryer, the following should be observed:

- Items that have been spotted or soaked with vegetable or cooking oil constitute a fire hazard and should not be placed in a tumble dryer.

Oil-affected items can ignite spontaneously, especially when exposed to heat sources such as in a tumble dryer. The items become warm, causing an oxidation reaction in the oil. Oxidation creates heat. If the heat cannot escape, the items can become hot enough to catch fire. Piling, stacking or storing oil-affected items can prevent heat from escaping and so create a fire hazard.

If it is unavoidable that fabrics that contain vegetable or cooking oil or have been contaminated by hair care products be placed in a tumble dryer they should first be washed in hot water with extra detergent - this will reduce, but not eliminate, the hazard. The 'cool down' cycle of tumble dryers should be used to reduce the temperature of the items. They should not be removed from the tumble dryer or piled or stacked while hot.

- Items that have been previously cleaned in, washed in, soaked in or spotted with petrol/gasoline, dry-cleaning solvents or other flammable or explosive substances should not be placed in a tumble dryer.

Highly flammable substances commonly used in domestic environments include acetone, denatured alcohol, petrol/gasoline, kerosene, spot removers (some brands), turpentine, waxes and wax removers.

- Items containing foam rubber (also known as latex foam) or similarly textured rubberlike materials should not be dried in a tumble dryer on a heat setting.

Foam rubber materials can, when heated, produce fire by spontaneous combustion.

- Fabric softeners or similar products should not be used in a tumble dryer to eliminate the effects of static electricity unless this practice is specifically recommended by the manufacturer of the fabric softener or product.

- Undergarments that contain metal reinforcements should not be placed in a tumble dryer.

Damage to the tumble dryer can result if metal reinforcements come loose during drying. When available a drying rack could be used for such items.

- Plastic articles such as shower caps or babies' waterproof napkin covers should not be placed in a tumble dryer.

- Rubber-backed articles, clothes fitted with foam rubber pads, pillows, galoshes and rubber-coated tennis shoes should not be placed in a tumble dryer.

VENTED DRYERS

- that there has to be adequate ventilation to avoid the back flow of gases into the room from appliances burning other fuels, including open fires, when operating the tumble dryer.

- that exhaust air must not be discharged into a flue which is used for exhausting fumes from appliances burning gas or other fuels

3 CHILDREN'S SAFETY



GENERAL

Young children should be supervised to ensure that they do not play with the appliance.

The tumble dryer is fitted with a magnetic catch, which allows the door to be pushed opened from the inside. The door is equipped with a switch, which automatically stops the tumble dryer when the door is opened. The machine will not start automatically on closing the door (eg, if a child should close the door from the inside). You must push **Start** to re-activate the dryer.



CHILD LOCK ON **Start** AND **Menu** BUTTONS

By locking the **Start** and **Menu** buttons, you can prevent that for example a child starts the machine or changes the settings by mistake.

Child lock On/Off

Turn the main power switch, , off and then turn it on again.

Press the **Enter** button five times, then press the **P3** button five times. These ten times must be completed within fifteen seconds.

Within three seconds after the last press on the **P3** button, use the   buttons to choose Child lock ON (the figure 3 will appear at the bottom right in the display) or OFF (the figure 0 will appear at the bottom right in the display).

To start a program with locked **Start button.**

Press the **Start** button for three seconds and the machine will start.

To change program settings with Child locked **Menu button.**

Press the **Menu** button for three seconds, after that the **Menu** button works normally again. If you do not press any button within two minutes, the **Menu** button will be locked again.

4 PARTS OF THE TUMBLE DRYER

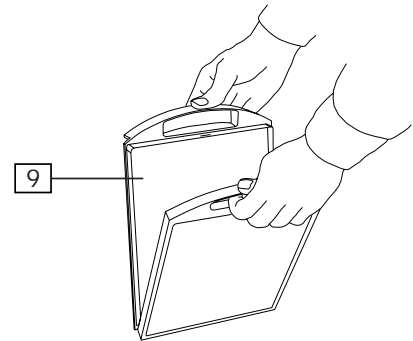
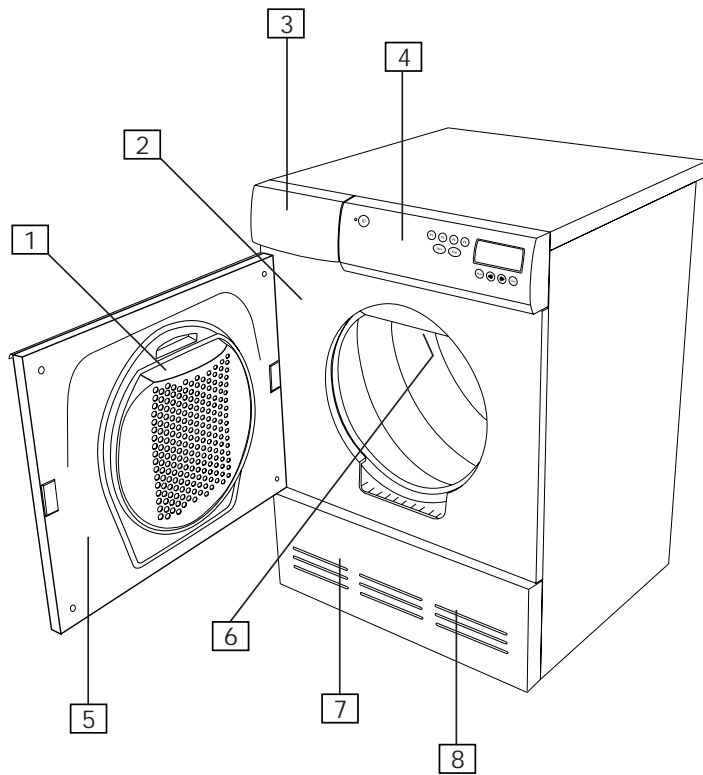

1. LINT-FILTER HOLDER

2. DATA PLATE

3. CONDENSATION WATER CONTAINER

4. PANEL

5. OUTER DOOR

6. INTERIOR LIGHTING (ON THE INSIDE)

7. FAN (BEHIND THE LOWER COVER)

8. CONDENSER (BEHIND THE LOWER COVER)

9. LINT FILTER

5 PANEL

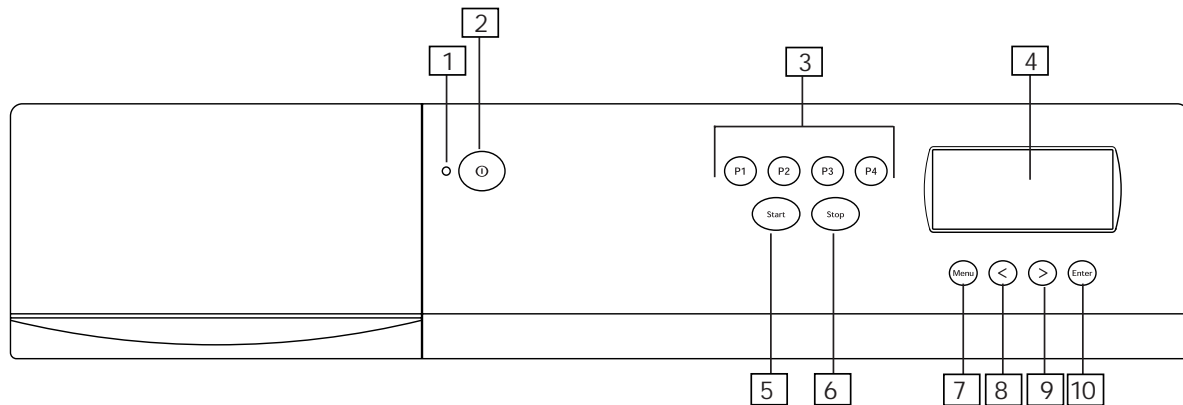

1. INDICATOR LAMP ON/OFF

2. MAIN POWER SWITCH

3. PROGRAM SELECTOR BUTTONS P4-P4

4. DISPLAY

5. START BUTTON

6. STOP BUTTON

7. MENU BUTTON

8. INDEX BACK/REDUCE TIME

9. INDEX FORWARD/INCREASE TIME

10. ENTER BUTTON

6 LC-DISPLAY

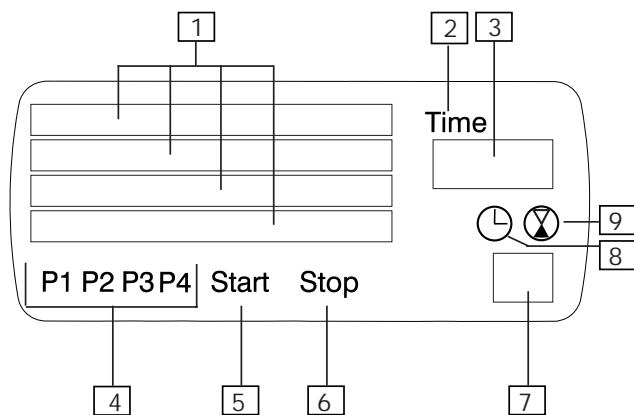

1. TEXT FIELD INDICATING PROGRAM, OPTIONS AND FAULT MESSAGES, ETC.

2. INDICATES THAT [3] IS SHOWING THE SELECTED TIME FOR A TIMED DRY OR AN AIR FLUFF PROGRAM

3. SHOWS THE SELECTED TIME FOR TIMED DRY PROGRAMS

4. INDICATES THE SELECTED PROGRAM

NOTE

The display will be extinguished if no buttons are pressed within three minutes. The display will be reinstated the next time any button is pressed.

5. INDICATES THAT A PROGRAM HAS STARTED

6. INDICATES THAT A PROGRAM HAS BEEN COMPLETED

7. SEE 8 AND 9 BELOW

8. INDICATES THAT DELAYED START IS ON. [7] THEN INDICATES HOURS REMAINING TO START

9. INDICATES THAT [7] IS DISPLAYING THE PROGRAM TIME REMAINING IN HOURS AND MINUTES (ALTERNATING), INCLUDING THE COOLING TIME.

7 BEFORE TUMBLE DRYING

Before you start tumble drying, here is some advice that can be useful.

SPIN-DRIED?

Items that are to be tumble dried should first be spin-dried, preferably at 800 revs per minute or more. Better spin drying saves both energy and drying time.

RECOMMENDED WASHING LABELLING



Material suitable for tumble drying

The symbol above indicates that the material can be tumble-dried. Cotton fabrics, towelling and synthetic fibres are best suited to tumble drying. Clothes and fabrics become softer and fluffier when tumble-dried than when dried on a line.

PLEASE NOTE

Wear and tear of fabrics in a tumble dryer is minimal. The lint caught in the lint filter consists of dust and fibre residue that has been formed when wearing the garments.



Material which should not be tumble-dried

This symbol indicates that the material will not withstand tumble-drying.

Certain materials will melt or become dangerously flammable if heated, while others will lose their shape or shrink.

Do not tumble-dry...

- Materials that are marked “Do not dry close to heat”.
- Items that have been dry-cleaned at home.
- Foam plastic.
- Glass-fibre materials
- Woollen items, because of the risk of felting.

SORTING FABRICS

Best results are obtained if all articles are of the same material.

Close zip-fasteners, button up garments, tie belts, and sort the fabrics and adapt the load and the temperature as shown in the table below.

TYPE OF FABRIC		LOAD	TEMPERATURE
White, coloured and synthetic	Cotton and linen	1/1 (5.0 kg)	Normal
	Polyester/cotton	1/2 (2.5 kg)	Normal
Delicate and mild	Acrylic, rayon, acetate etc.	1/2 (2.5 kg)	Low

Sort a suitable amount and type of fabric.





PROGRAMS

Your choice of program will depend on what you wish to do with the fabrics after tumble drying. The programs are Extra dry, Dry, Normal dry, Iron dry, Timed dry and Air fluff.

Extra dry

This program is designed for washing that is extremely difficult to dry, eg, jeans with very thick seams.

PLEASE NOTE

Knitted fabrics in particular are likely to shrink. Use the Dry, Normal dry or Iron dry program for these materials. Always stretch garments out directly after drying.

Dry, Normal dry

These programs turn off the heat when the washing is dry, but not bone-dry.

The Dry program turns off the heat a little later than Normal dry. Choose what you prefer by trial and error. Use these programs when you want dry fabrics.

Iron dry

This program turns off the heat when the washing is just damp enough for ironing or mangling.

Timed program

The program length that you should choose depends on what you wish to do with the fabrics after tumble drying. Use different times for different materials to find the right combination.

When using a timed program with mixed washing it may happen that some of the items will not be sufficiently dried. Such items can suitably be dried by running the timed program for a further 10 minutes or so.

The timed dry programs automatically operate at a low temperature, but you can change it yourself to Normal.

NOTE

When using a timed program it is possible to over-dry fabrics if you set it for too long a time. This can cause fabrics to shrink or crease and feel rough. Synthetic materials can also become charged with static electricity. Set a shorter time if you tumble dry at temperature Normal.

Air fluff program

Use the air fluff program just to remove dust out of garments, air them or soften them up.

To select Timed program or Air fluff program, see Chapter 10, Making own drying programs.

OPTIONS

Cooling

You can choose between Normal cooling and Quick cooling. Normal cooling lasts 20 minutes and Quick cooling lasts 5 minutes.

Buzzer

The machine offers you the possibility to choose an audible signal. Set the option Buzzer ON and it will sound for three seconds when the program is completed.

Anti-crease program

Using the Anti-crease program you can prevent garments from lying still and becoming unnecessarily creased at the end of tumble drying. This is a helpful option if you cannot take out garments promptly at the end of the tumbling phase.

You can choose this option for a duration of 1, 2 or 3 hours. The drum will then continue to rotate intermittently, ie, three seconds every minute for the number of hours chosen.

If you choose Buzzer ON, a signal will sound each time the drum rotates.

To choose these options, see Chapter 10, Making own drying programs.

TEMPERATURE

You can choose temperature Normal or Low, see chapter 10, Making own drying programs.

DRYING TIME

The drying time may be influenced by a number of factors, such as the size of the load, the program selected, the moisture content of the load, the materials being washed, connection capacity and the ambient temperature and humidity. Drying time remaining is calculated within four minutes of the start of the drying program. The estimated time is shown in the bottom right-hand corner of the display, together with the – symbol.

If the actual drying time is less than that calculated, the time display may jump ahead, e.g. from 50 to 20 minutes, at the end of the program.

8 TUMBLE DRY



TUMBLE DRYING WITH EASY CONTROL

Easy tumble drying by pushing a few buttons

Your tumble dryer works like a radio with pre-set tuning. Instead of radio stations, however, you select your preferred drying program in this case. We have preset the (P1)-(P4) buttons with four common programs.

Switch on the dryer and press the button for your preferred program. You then simply press the Start button to start the program.

To alter the settings for (P1)-(P4)

You can create your own favourite programs, if you wish. You can even preset Timed dry and Air fluff programs.

You can also adapt settings and options such as temperature, buzzer, cooling and delayed start to suit your particular needs.

Chapter 10 - Making your own drying programs, tells you what to do to create a temporary or permanent drying program. It also includes a description of all the available program types, options and other settings.

1 SORT FABRICS

For tips and advice, see Chapter 8 – Before tumble drying.

PLEASE NOTE

Empty the pockets. Coins, nails and similar items can cause damage to the dryer.

2 TURN ON THE MAIN POWER SWITCH (ⓘ)

3 OPEN THE DOOR, PUT IN THE WASHING AND CLOSE THE DOOR AGAIN

See Chapter 7 for the recommended quantity of washing – Before tumble drying.

4 SELECT A PROGRAM

The dryer has four pre-set programs. Press the button for the desired program. The programs are shown in the table below.

Your choice of program will depend on what you wish to do with the fabrics after tumble drying. See also Chapter 7 – Before tumble drying.

SETTINGS OF THE FOUR PRE-SET PROGRAMS.

PROGRAM BUTTON	PROGRAM	Cooling	Buzzer	OPTIONS Anti-crease program	TEMPERATURE	DELAYED START
P1	EXTRA DRY	NORMAL	ON	ON, 1 h	NORMAL	0 h
P2	DRY	NORMAL	ON	ON, 1 h	NORMAL	0 h
P3	NORMAL DRY	NORMAL	ON	ON, 1 h	NORMAL	0 h
P4	IRON DRY	NORMAL	ON	ON, 1 h	NORMAL	0 h

5 START TUMBLE DRYING

Press the  button. The text **Start** at the lower edge of the display indicates that the program has started. The text field of the display shows the current stage of the program while it is in progress.

NOTE

If the child lock is on, the  button must be held down for 3 seconds in order for the program to start. See Chapter 3, Child safety, for details of how to switch the child lock on and off.

Remaining drying time

The approximate remaining drying time is estimated within four minutes of the start of the drying program. Only the time for the Timed dry program and Air fluff program is indicated for venting dryers.

The time is shown in hours and minutes (alternating) at the bottom right of the display together with the  symbol. Note that the time also includes cooling.

DURING TUMBLE DRYING

Putting in more washing

Open the door and the drum will stop automatically. To restart: Close the door and press the  button.

Changing program

Press the  button for three seconds. The program will then be zero set and you can choose a new program.

6 DRYING PROGRAM ENDED

The text **Stop** on the bottom edge of the display indicates that the program has ended.

If the Anti-crease option is activated, the drum will rotate every minute for a certain period after cooling. The text [“Anti-crease”] is indicated in the display during this period. The program can be stopped at any time by opening the door.

When the program ends:

- Clean the lint filter after each drying operation, see below. An error message will be displayed if the lint filter needs to be cleaned.
- Empty the condensation water container.

WARNING!



Regularly clean the lint filter. If the lint filter becomes completely clogged the overheat protection device may trigger. The device must then be reset to enable the machine to be started, see Chapter 12, Trouble shooting.



CLEANING THE LINT FILTER

1. Grasp the filter handle and pull towards you.
2. Pull the filter up out of the holder.

3. Open the filter and brush away the lint with your hand.

4. Fold the filter together and put it back in the filter holder.

The filter may require cleaning if lime scale deposits are present; see Chapter 10, Care and Cleaning.

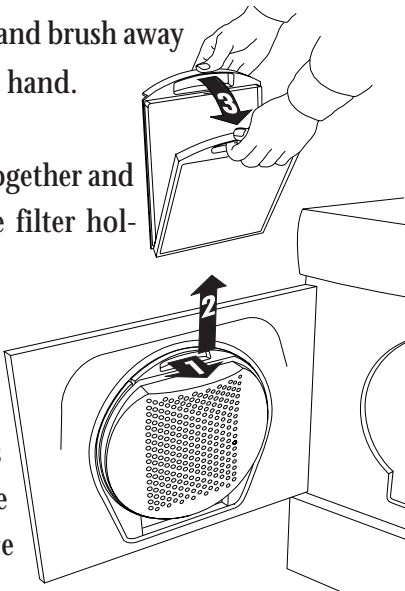

NOTE

Regularly clean the lintfilter.

EMPTYING THE CONDENSATION WATER CONTAINER

Empty the condensation water container after each tumble drying.

Pull out the condensation water container, empty the water and put the container back.

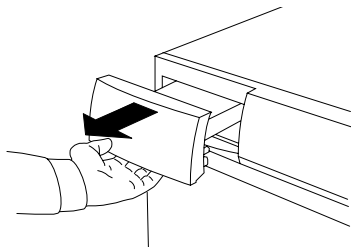

If the container becomes too full, the program will be interrupted and an error message will be displayed in

the text field. Empty the container and press the **Start** button and the program will continue from where it was interrupted, see also Chapter 12, Trouble shooting, heading Fault indications.

NOTE

Do not pull out the condensation water container while the machine is running.

HINT



The condensation water is soft, and is therefore suitable for use in a steam iron. Strain the water through a coffee paper filter before use. If you want the water to be emptied automatically, see the Installation instructions.

AFTER TUMBLE DRYING

Turn off the main switch **⓪**.

AUTOMATIC DRAINING

See the Installation Instructions if you require the water to be drained automatically.

TEMPORARY PROGRAM

If you wish to run a program without altering the pre-set programs **P1**-**P4**, you can create a temporary program; see Chapter 10 - Making your own drying programs.

DELAYED START (1-24 HOURS)

If Delayed start is set to 5 hours, for example, this means that the machine will start the program 5 hours after you press the **Start** button.

If you wish to delay the start of any program temporarily, you should proceed as follows before pressing the **Start** button:

1. Select the program, but do not press the **Start** button.
2. Index forward with the **Menu** button until Delayed start appears in the display.
3. Index forward to the desired number of hours with **<** **>**.
4. Press the **Enter** button once. The selected program appears in the display.
5. Press **Start** to start the program.

Delayed start is disconnected automatically at the end of the program.

9 CONSUMPTION VALUES - PRE-SET DRYING PROGRAMS

The following conditions apply for the consumption values indicated below:

Temperature of intake air: 20 °C.

Humidity of intake air: 65 %.

Drying temperature: Normal (Ⓕ), Low (Ⓖ).

Element power: 2500 W.

The cotton fabrics are, before tumble drying, spin-dried at 800 and 1600 rpm (long spin) with an ASKO washing machine.

Other fabrics (creasfree and acrylics) are, before tumble drying, spin-dried at 800 rpm (short spin) with an ASKO washing machine.

PROGRAM	WASHING	AMOUNT OF WASHING	ENERGY CONSUMPTION (ca kWh)		PROGRAM TIME (ca minutes)	
			800 rpm	1600 rpm	800 rpm	1600 rpm
P1 Extra dry	Cotton, linen, Ⓕ	1/1 (5.0 kg)	3.8	3.1	120	105
P2 Dry	Cotton, linen, Ⓕ	1/1 (5.0 kg)	3.5	2.8	110	95
	Crease free, polyester/cotton, Ⓕ	1/2 (2.5kg)	1.3	---	55	---
P3 Normal dry	Cotton, linen, Ⓕ	1/1 (5.0 kg)	3.2	2.4	95	80
	Crease free, polyester/cotton, Ⓕ	1/2 (2.5kg)	1.1	---	50	--
	Acrylics, rayon, acetate, Ⓖ	1/2 (2.5 kg)	1.5	---	75	---
P4 Iron dry	Cotton, linen, Ⓕ	1/1 (5.0 kg)	2.5	1.5	95	65

10 MAKING OWN DRYING PROGRAMS

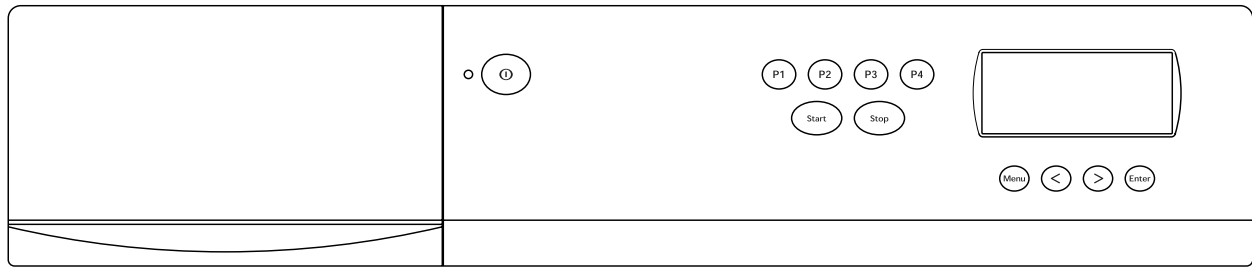

We have preset **P1**-**P4** with the most common drying programs; see the table below. These programs usually suit most users.

You can also create your own programs to suit you and your washing needs even better.

You can select a different type of program, for example a Timed dry program and an Air fluff program, or you can alter settings and options such as Buzzer, Temperature, Non-iron, Cooling or Delayed start.

This Chapter includes tables containing information about all program types, settings and options.

Change program

In this Chapter we tell you how to replace one or other of the pre-set programs with a program of your own.

By storing the program, it will then be accessible simply by pressing a button every time you wish to use the tumble dryer.

Temporary program

You can also make a temporary change of programs, settings and options. The change is not stored in this case, but is deleted as soon as the program is completed and the door is opened.

SETTINGS OF THE FOUR PRE-SET PROGRAMS.

PROGRAM BUTTON	PROGRAM	Cooling	Buzzer	OPTIONS Anti-crease program	TEMPERATURE	DELAYED START
P1	EXTRA DRY	NORMAL	ON	ON, 1 h	NORMAL	0 h
P2	DRY	NORMAL	ON	ON, 1 h	NORMAL	0 h
P3	NORMAL DRY	NORMAL	ON	ON, 1 h	NORMAL	0 h
P4	IRON DRY	NORMAL	ON	ON, 1 h	NORMAL	0 h



AVAILABLE SETTINGS AND OPTIONS

Setting/Option	Description	Restrictions
Program types	Available programs are described in a separate table. Change of program type resets all options and settings to their original values.	
Temperature, low/normal	Drying temperature.	All programs without Air fluffing.
Delayed start (0-24 hours)	If you select a delayed start of five hours, for example, the machine will start five hours after you pressed the start button. The time remaining until the start is shown in the display. The change to this option is not stored permanently.	Can be used with all programs.
Buzzer On/Off	With Buzzer On, a 3-second buzzer signal will be heard at the end of the program.	Can be used with all programs.
Crease-free 0-3 hours (0-180 min)	The drum will rotate for 3 seconds per minute for the indicated period after the end of the drying program. With Buzzer On, a buzzer signal will be heard each time the drum rotates. Can be interrupted at any time by opening the door.	Can be used with all programs.
Cooling, Normal/Short	Normal cooling continues for 20 minutes, and short cooling for 5 minutes..	All programs without Air fluffing.

AVAILABLE PROGRAM TYPES

Program type	Description	
Extra dry	Program that gives the driest fabrics.	
Dry	Shuts off the heat when the fabrics are dry, but without being snuff-dry. Dry shuts off a little later than Normal dry.	
Normal dry	Shuts off the heat when the fabrics are dry, but without being snuff-dry.	
Iron dry	Shuts off the heat when the fabrics are still slightly damp.	
Timed dry program	You decide the duration of the program by using an individual setting as described below. You can also change the duration with the < > buttons on each occasion before you use the program (before you press Start).	
Air fluff program	A program without drying heat, under which you select the duration of the program (see Timed dry program).	

CREATE YOUR OWN DRYING PROGRAM

1. Press one of the buttons (P1)-(P4) under which you wish to store your program. You can select any button you like if you only want to make a temporary program.

2. Index forward with the (Menu) button to the first setting or option that you wish to change. If the child lock is activated, nothing will happen. Hold down the button for 3 seconds, and then press as usual.

All the program types, settings and options are described in the table alongside.

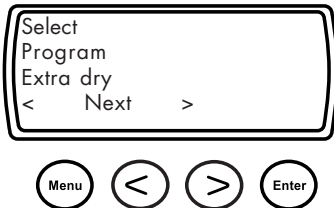

3. If you wish to change a setting, you should index forward or back with the (<) (>) buttons until the desired setting appears in the display.

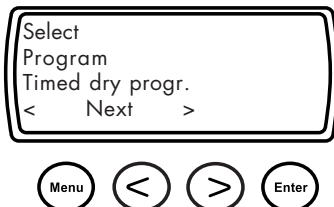

4. Then index further with the (Menu) button to the next setting/option, and change it in the same way if required.

5. Index further and make changes in the same way until the finished program appears in the display together with any options. The text Stop will be displayed on the bottom line.

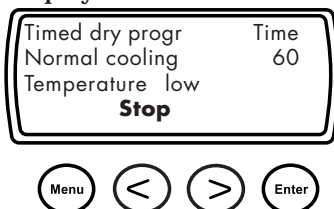

You can now use the program without storing it (temporary program). Press the (Start) button to start the program.

Store the program

If you wish to store the program for use whenever you intend to use the tumble dryer, press the (Enter) button before starting. The button selected by you originally (P1-P4) will appear at the bottom left of the display.

You can now select the program by pressing the button chosen by you in Step 1.

NOTE

The Delayed start option is not stored permanently.

IMPORTANT

If you store a program by mistake, you can reset it to its settings at the time of delivery; see Reset program later in this Chapter.

TIP

If you do not wish to index through all the settings, you can terminate the input by pressing the (Enter) button ONCE. To store the program, you must then press the (Enter) button once more.

INTERRUPT INPUT

If you change your mind and wish to interrupt the input sequence, you should switch off the dryer with the main power switch (⊖). When you switch it on again, you can start from the beginning or select one of the pre-set programs as usual.





RESET PROGRAM

If you wish to revert to the settings which a pre-set program had at the time when the dryer was supplied, you can reset the program. Proceed as follows:

1. Hold down the program button (P1-P4) for the program that you wish to reset.
2. Press the  button once.
3. Release the program button.

The program for the button concerned will now have reverted to its settings at the time when the dryer was supplied.

MENU SYSTEM FOR CHANGING A PRESET PROGRAM

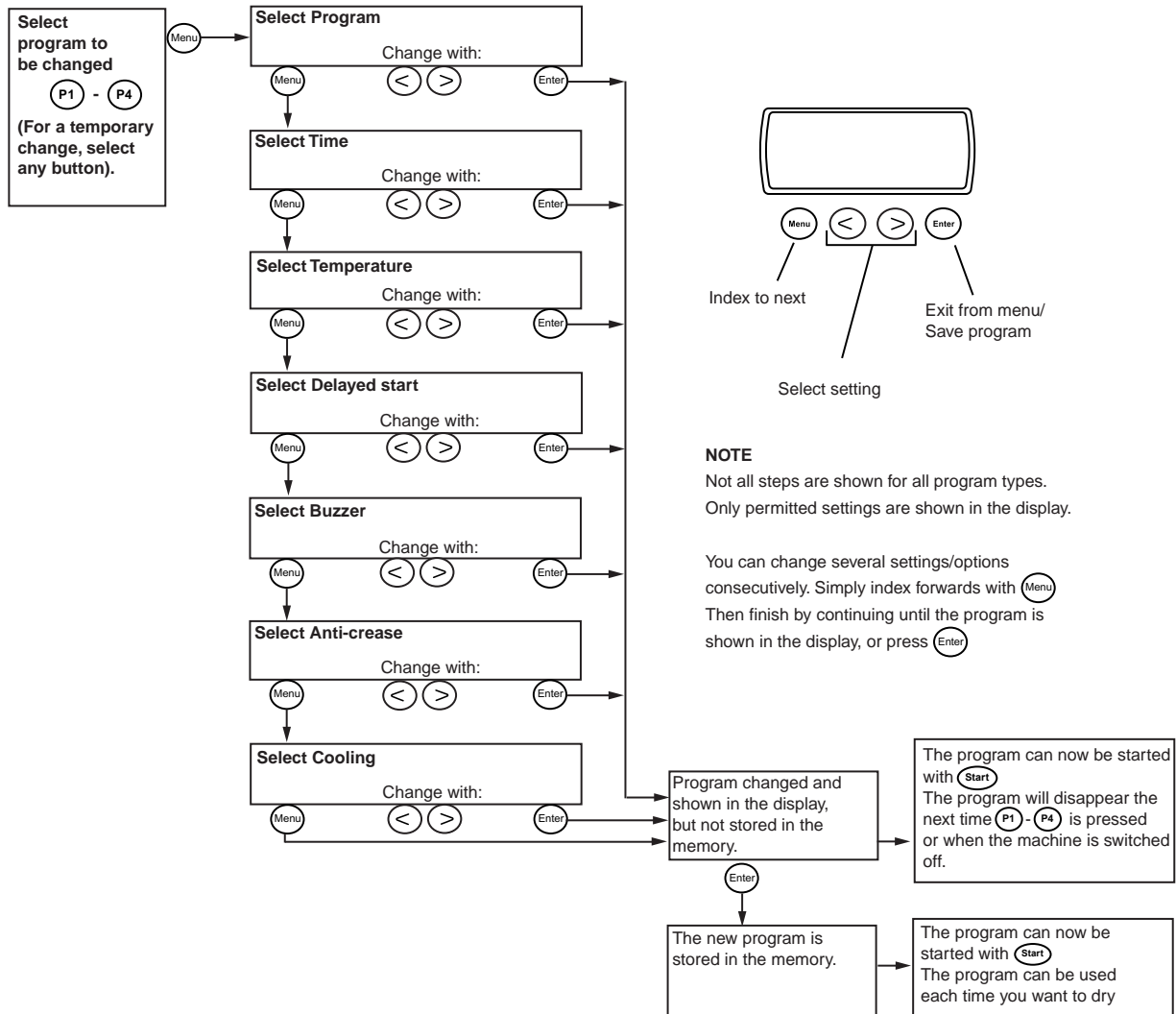

This page has been left blank for technical printing reasons.

11 CARE AND CLEANING

CLEANING THE LINT FILTER

Clean the lint filter after each tumble drying operation.

If your water is very hard a deposit of lime may be formed on the filter. Check when cleaning lint from the filter if there is any sign of lime, if so wash the lint filter by hand to remove any deposits.

1. Grasp the filter handle and pull towards you.

2. Pull the filter up out of the holder.

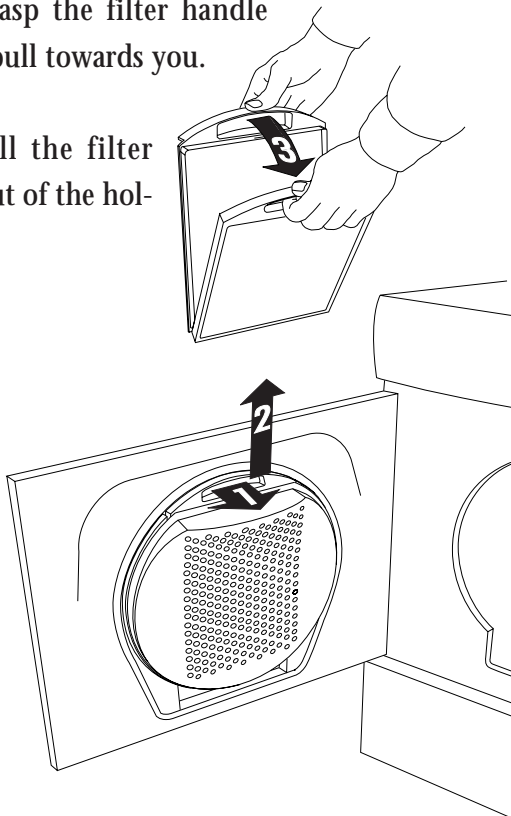

3. Open the filter and remove fluff from all sides of the filter by hand. Use a soft dry cloth to remove any remaining fluff.

4. Replace the filter in the filter holder.

NOTE

If limescale develops on the filter, rinse it in water to remove the limescale.

Dry the filter thoroughly with a hand towel.

EMPTYING THE CONDENSATION WATER CONTAI-

NER

Empty the condensation water container after each tumble drying.

Pull out the condensation water container, empty the water and put the container back.

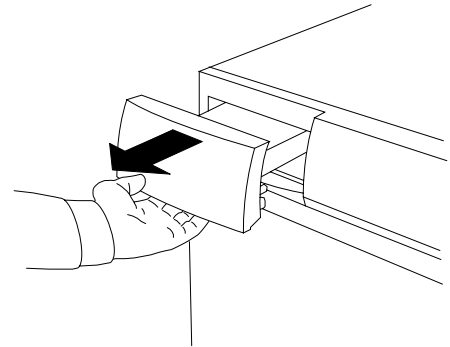

If the container becomes too full, the program will be interrupted and an error message will be displayed in the text field. Empty the container and press the **Start** button and the program will continue from where it was interrupted, see also Chapter 12, Trouble shooting, heading Error messages.

NOTE

Do not pull out the condensation water container while the machine is running.

CLEANING THE OUTSIDE OF THE MACHINE

Use a mild detergent to clean the outside of the machine. Do not use any solvents, they can damage the machine. Do not spray the machine with water.

NOTE

Do not allow dust to accumulate round the machine. Keep clean and cool around the tumble dryer. Dust, heat and moisture prolong the drying time.



CLEANING THE FAN

The fan should be cleaned at least once a year. If you have any household pets the fan must be cleaned more often.

1. Turn off the main power switch.

2. Remove the lower cover.

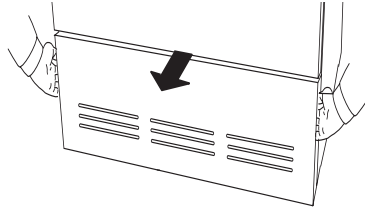

3. Remove the safety screw (1). Prise out the four clips in the order shown and remove the fan cover.

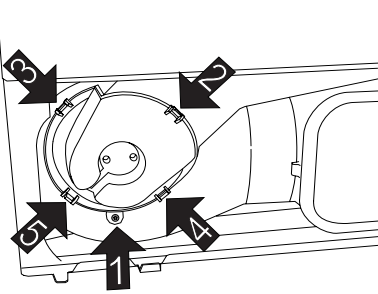

4. Unscrew the nut while holding the fan.

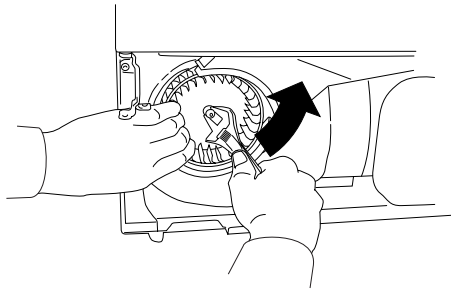

5. Take out the fan and clean it with a brush and water.

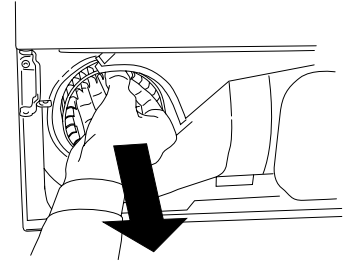

6. Put the fan back into place and screw on the nut.

7. Refit the fan cover, making sure the clips hold the cover in place. Don't forget to fit the safety screw.

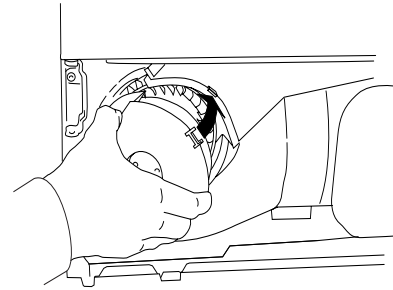

8. Fit the lower cover back in place.

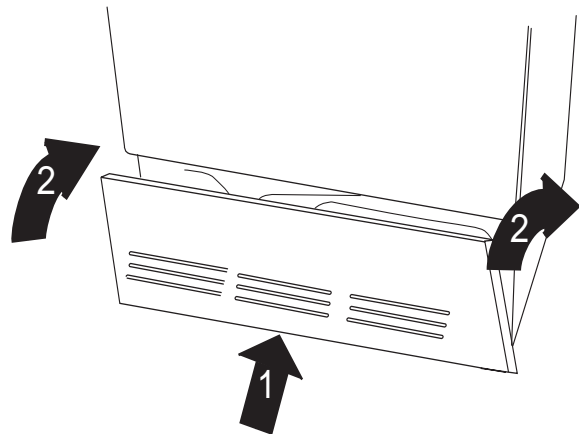

CLEANING THE CONDENSER

The condenser should be cleaned at least three times a year. . If you have any household pets the condenser must be cleaned more often.

1. Turn off the main power switch.

2. Remove the lower cover.

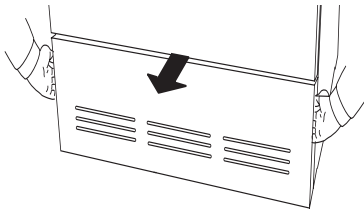

3. Turn the two levers anticlockwise to open the condenser cover.

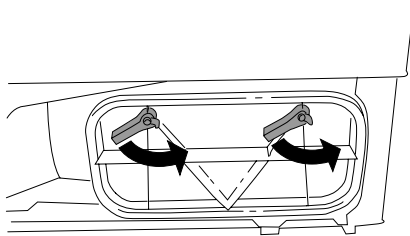

4. Take the condenser out and rinse the condenser fins clean, eg, using a hand-held shower.

Do not poke anything between the fins, you might damage the condenser. Do not use any sharp object when cleaning the fins.

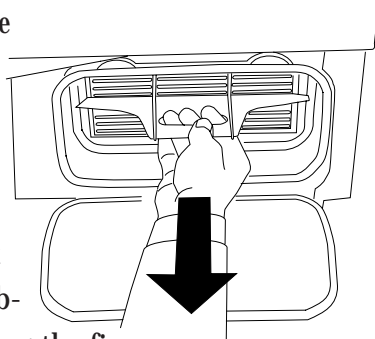

NOTE

Do not attempt to clean the condenser in a dishwasher.

5. Refit the condenser, taking care to fit it the right way up.

The top of the condenser is marked “upp”, “up” and “oben”.

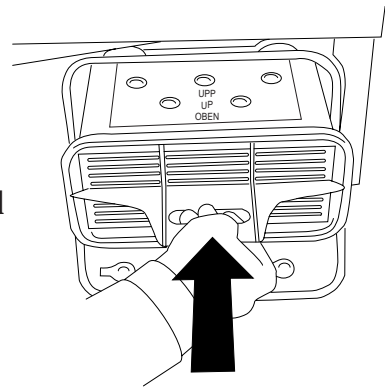

6. Fit the lower cover back in place.

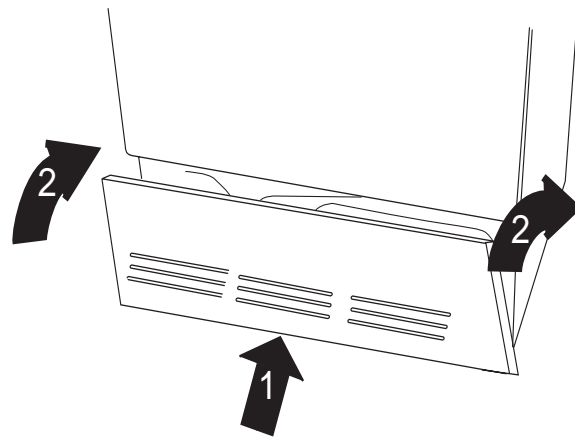

12 TROUBLE SHOOTING

THE MACHINE WILL NOT START

Check that:

- The door is properly closed.
- The main switch is pressed in.
- You have correctly set the required program or the required time in the timed dry program.
- You have not chosen Delayed start.
- The electric plug, if any, is firmly inserted in its socket.
- All fuses are intact. Switch two fuses over. It is not always possible to see directly if a fuse has blown.
- The overheating device has not triggered, see below.

OVERHEATING PROTECTION

The overheating protection device switches off the tumble dryer if the temperature becomes too high, eg, because the lint filter is clogged. If this happens, clean the filter, empty the water container and clean the condenser. Then reset the overheating device by pressing the black rubber button on the back of the machine.

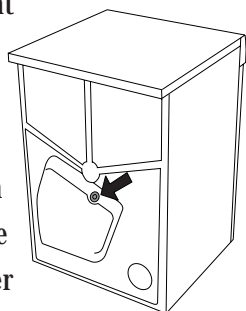

NO INTERIOR LIGHTING

Check that:

- The main switch is pressed in.
- The electric plug, if any, is firmly inserted in its socket.
- All fuses are intact. Switch two fuses over. It is not always possible to see directly if a fuse has blown.

- The bulb is not burnt out. The lamp is located at the top of the dryer just inside the door. Screw off the plastic cover protecting the bulb and screw out the bulb and replace it.

EXCESSIVE DRYING TIME

Empty the water container and check that the lint filter and the condenser are not clogged, see Chapter 11, Care and Cleaning. Excessive drying times can also be caused by the machine being installed in a very confined space and by the air in the room (which cools the machine) becoming too warm. In this situation make sure that ventilation is improved, eg, by opening doors and/or windows.

FAULT INDICATIONS

Error messages appear in the display text field if faults occur while a program is in progress. To exit the error messages after correcting the fault as described below, switch the machine off or change the program.

The error messages that can be displayed are:

Maximum program time. When the machine has run for its maximum time (three hours) it will stop. Ensure first that all fuses for the machine are intact. To exit the error message, switch the machine off or open the outer door. If this does not help, phone for service.

Over flow. Indicating that the condensation water container is overfilled. Empty the container and restart. If the message is repeated it may be because the lower water magazine is full, due to the pump or hoses being clogged or malfunctioning.

ning. If condensation water is pumped out direct to the drain, check to ensure there are no kinks or stoppage in the hose. If this does not help, phone for service.

Sensor fault. Fault in the moisture sensor. This error message can also appear if you should start the dryer when it contains dry items or when it is empty. To cancel the message, simply open the dryer door. If this does not work, phone for service.



Thermistor fault. Phone for service.



WRONG LANGUAGE ON THE DISPLAY

If the language on the display becomes altered for any reason, it can be restored to the initial language again.

The available languages are Dansk, Deutsch, English, Espanol, Français, Italiano, Nederlands, Norsk, Português, Suomi and Svenska.

Proceed as follows to change the language:

Turn the main power switch, , off and then turn it on again. Press the  button five times, then press the  button five times. These ten times must be completed within fifteen seconds.

Within three seconds after pressing  the last time, step to the desired language using the   buttons.

RESET PROGRAM

If you wish to revert to the settings which a pre-set program had at the time when the dryer was supplied, you can reset the program. Proceed as follows:

1. Hold down the program button for the program that you wish to reset.
2. Press the  button once.
3. Release the program button.

The program for the button is now reset to its settings when the dryer was supplied.

STOP FLASHES IN THE DISPLAY



The program has stopped temporarily because the door has been opened, the main power switch has been turned off or the power supply has been interrupted.

To restart: Press the  button.

To interrupt the program completely: Press the  button for three seconds.

13 TECHNICAL INFORMATION

TECHNICAL DATA

Height:	850 mm
Width:	595 mm
Depth:	585 mm
Weight:	47 kg
Drum volume:	111 litre
Max drying capacity:	5.0 kg
Speed:	52 r/min
Rated power:	See data plate
Material: Cylinder	Stainless steel
Material: Outer cover	Hot-galvanized, powder-lacquered steel or stainless steel
Positioning:	Washing tower or free-standing
Drain	2.0 polypropylene hose
Interior light:	10 W, plint E14.

STANDARD TESTS

Europe:	EN 61 121 (95/ 13/ EEC).
Drying performance: temperature Normal.	Program 3, (Normal dry), 5.0 kg, cotton,
Energy declaration:	EN 61 121 (95/ 13/ EEC).
temperature Normal.	Program 3, (Normal dry), 5.0 kg, cotton,
Procedure for acoustic measurement:	IEC 704-2-6.

14 SERVICE AND GUARANTEE

SERVICE

Before calling for service, check to see whether the faults is due to something that you can rectify yourself. See chapter 12, Trouble shooting.

If you do require service, telephone your local ASKO retailer or the ASKO representative for your country. See guarantee card for address and telephone number.

GUARANTEE

For guarantee details, see the guarantee card.

BEFORE CONTACTING THE SERVICE DEPARTMENT

Before contacting the Service Department, make a note of the model number, type designation and serial number.

The model number is on the panel. The type designation and the serial number are on the type plate located inside the door.

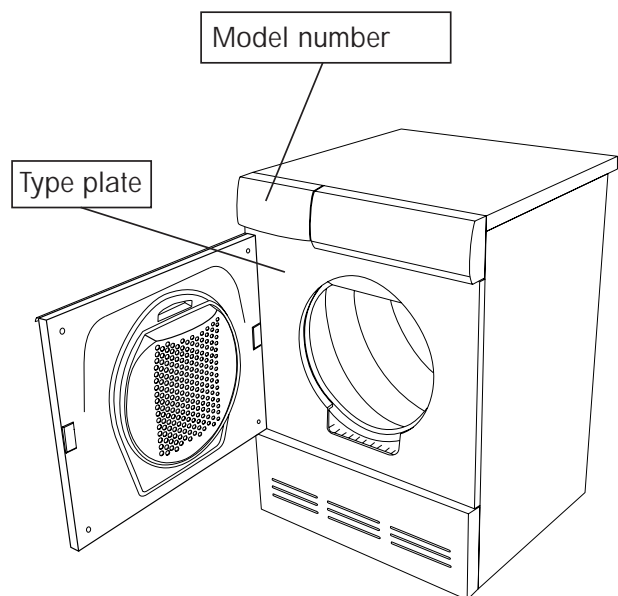
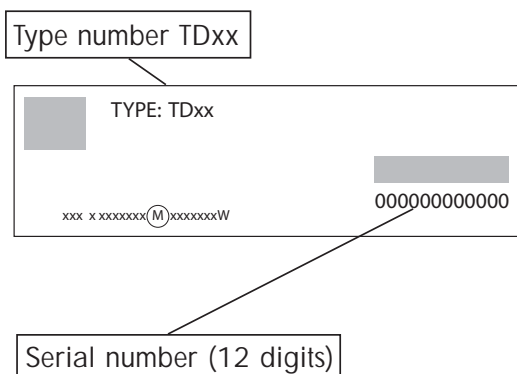

15 QUICK GUIDE

1. Sort the fabrics.

2. Turn on the main switch .

3. Open the door, load the fabrics and close the door again.

Close the door carefully, and avoid slamming it.

4. Select a program.

The dryer has four pre-set programs; see the table. Press the button for the desired program.

5. Press the  **button.**

6. Drying program completed.

Open the door and take out the tumble-dried fabrics. The lint filter must be cleaned and the condensation water tank must be emptied after each tumble drying operation.

7. When tumble drying is completed.

Turn off the main power switch .

For details of how to use the Timed dry and Air fluff programs, see Chapter 10, Making your own drying programs.

WASHING →	<i>Cotton, linen etc</i>	<i>Polyester/cotton</i>	<i>Acrylics, rayon, acetates, (temperature sensitive materials)</i>
Load (kg)	5.0	2.5	2.5
SET THE: Program	P1 to P4 Extra dry, Dry Normal dry, Iron dry	P2 or P3 Dry or Normal dry	P2 or P3 Dry or Normal dry
Temperature	Normal	Normal	Low

16 INDEX

	Chapter		Chapter	Chapter
A		F		
Acetate	7,15	Fault indications	12	Parts of the tumble dryer 4
Acrylate	7,8,15	Felting	7	Polyester 7,15
After tumble drying	8,15	Flammable material	2,7	Power consumption 9
Air fluff program	7, 8, 10	Foamed plastic	7	Pre-set drying program 8, 15
Altering settings	10			Program position 8
Anti-crease program	7,8,10	G		Programs 7,8,10,15
		Glass-fibre material	7	Q
B		Guarantee	14	Quick guide 15
Before tumble drying the first time	1	I		
Before tumble drying	7	Installation, see Instructions for installation		R
Belts	7	Interrupt program	2, 8	Rayon 7,15
		Iron dry	7,8,10,15	Recommended washing marking 7
C		Ironing	7	Remaining drying time 7
Change program after starting	8	J		Reset pre-set program 10,12
Children's safety	3	Jeans	7	Restarting 8
Child safety start	3	K		S
Cold ironing	7	Knitted fabrics	7	Safety 2
Coloured washing	7	L		Service 14
Condensation water container	8,11,12	Language	12	Signal 7,10
Condenser	11,12	LC Display	8	Sorting textiles 7
Cooling	7,8,10	Linen	7,15	Spin-dried 7
Cotton	7,15	Lint filter	8,11	Start 8,15
Crease-free, see Anti-crease program		Low temperature	7,8,10	Synthetic fabrics 7
		M		T
D		Making own drying programs	10	Technical data 13
Delayed start	10	N		Temperature 7,8,10
Delicate washing	7	Normal dry	7,8,10,15	Temporary program 10
Display, see LC Display		Normal temperature	7,8,10	Textile wear 7
Disposal	2	O		Timed dry program 7, 8, 10
Do not tumble dry	7	Options	7,10	Tumble dry 8,15
Dry	7,8,10,15	Overheating protection	2,12	W
Dry cleaning	2,7	Own programs	10	Wool 7
Drying time	7	P		Z
		Packing material	2	Zip fastener 7
E		Panel	5	
Emergency stop, see Interrupting the program				
Error indications, see Fault indications				
Extra dry	7,8,10,15			

