

This Owner's Manual is provided and hosted by [Appliance Factory Parts](http://www.appliancefactoryparts.com).

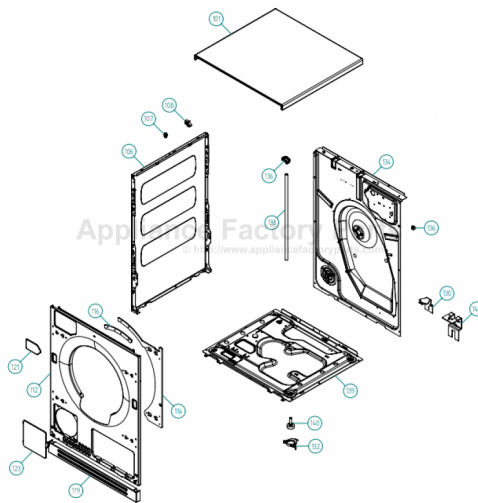

ASKO T793CWH Owner's Manual

[Shop genuine replacement parts for ASKO T793CWH](#)



[Find Your ASKO Dryer Parts - Select From 74 Models](#)

----- Manual continues below -----

Operating Instructions

Tumble dryer

Save these instructions for future reference

Dear ASKO Customer,

Thank you for choosing this quality product from Scandinavia, which was made in Sweden.

We want you to feel assured that the inside of your new machine is just as good as the outside and that the ethics and standards that went into the production of this machine are just as high as the quality and performance that you will receive from it. We hope that this product will give you many years of pleasure.

To ensure that you get the most out of your new machine, we recommend that you read the operating instructions before using the machine. The operating instructions also contain information on how to avoid damaging the environment.

ASKO T793C

 **ASKO**

Contents

Before using your machine for the first time	4	Settings	17
Do not tumble dry	4	You can alter the following settings:	17
Important safety instructions	5	How to choose the settings:	17
Installation	5	Clock	17
Grounding instructions	6	Buzzer Volume	17
Interrupting a program	6	Language	17
Transport/Winter storage	6	Child-safe Start	18
Packing material	6	Care and maintenance instructions	19
Disposal	6	Cleaning the lint filter	19
Child safety	7	Cleaning the outside of the machine	19
General	7	Cleaning the condenser	20
Activating Child-safe Start	7	Troubleshooting	21
To temporarily deactivate Child-safe Start:	7	The machine will not start	21
Description of the tumble dryer	8	Overheating cut-off	21
Front panel	9	Drying takes too long	21
Advice and tips before you tumble dry	10	The laundry does not dry, or is too dry	21
Have the clothes been spun?	10	Error messages	21
Materials that can be tumble dried	10	Technical information	22
Materials that should not be tumble dried	10	Technical data	22
Static electricity	10	Service and guarantee	23
Operating instructions	11	Warranty	24
Sort your fabrics	11	How to contact the ASKO Appliances Inc.	24
Turn on the main power switch.	11	Installation instructions	25
Open the door, load the items, and then close the door	11	Positioning the tumble dryer	25
Select the program	11	Adjusting the feet	28
Selecting Options	14	Condensed water	28
Press the Start button	15	Electrical installation	28
Drying program finished	15	Reversing the door	31
Once drying has finished	16	Follow these instructions:	32

Contents

Quick guide	36
Fabrics	36
Turn on the main power switch	36
Load the laundry	36
Select a program and any options	36
Press the Start button	36
Drying program finished	36
Once tumble drying has finished	36

Before using your machine for the first time

Do you need this Use&Care Guide in spanish? Log onto www.askousa.com/customer-care to download.
¿Necesita esta Instrucciones de uso y cuidado en español? Entre en www.askousa.com/customer-care y descárguela.

Do not tumble dry

Certain materials are not suitable for tumble drying. Always check and follow the instructions on each item's laundry label. You can find more information in the "Advice and tips before you tumble dry" chapter.

Note!

When starting the tumble dryer for the first time or after a long period without use, you may hear a slight thumping noise. This noise is completely normal and will disappear after a few loads.

See the Quick guide on the last page.

Important safety instructions

Save these instructions for future reference

Installation

See the "Installation" chapter.

Warning!



WARNING - To reduce the risk of fire, electric shock, or injury to persons when using your appliance, follow basic precautions, including the following:

- Read all instructions before using the appliance.
- Do not wash or dry articles that have been previously cleaned in, washed in, soaked in, or spotted with gasoline, dry-cleaning solvents, cooking oils, other flammable or explosive substances as they give off vapors that could ignite or explode.
- Do not allow children to play on or in the appliance. Children should be closely supervised when near the appliance.
- Before the appliance is removed from service or discarded, remove the door to the drying compartment.
- Do not reach into the appliance if the drum is moving.
- Do not install or store this appliance where it will be exposed to the weather.
- Do not tamper with controls.
- Do not attempt to repair or replace any part of the appliance or perform any servicing unless specifically recommended in this guide.
- Do not use fabric softeners or dryer sheets unless the manufacturer gives written assurance that the product will not damage a tumble dryer.
- Do not heat-dry items containing: vinyl, plastic, foam rubber or similarly textured rubberlike materials, fiberglass, or wool unless wool unless the label specifies "washable".

- Clean the lint filter before or after each load.
- Keep the area around the exhaust opening and adjacent surrounding areas free from the accumulation of lint, dust and dirt.
- The interior of the machine should be cleaned periodically by an authorized ASKO service agent.
- Do not place items exposed to cooking oils in your dryer. Items contaminated with cooking oils may contribute to a chemical reaction that could cause a load to catch fire.
- Electrical installation, if required, must be done by a licensed electrician.
- Do not operate appliance while away from the home.
- Do not heat dry items that have been dry-cleaned.
- The dryer is made and marked to facilitate recycling. When it is no longer useful, contact your local refuse collection service for advice on how to properly dispose of the dryer for purposes of recycling.
- Damaged power cables should only be replaced by a certified professional.
- Provide sufficient ventilation, otherwise smoke from open fires or fumes from equipment burning other fuels can be drawn into the room.

Caution!

During the program, the back of the dryer will get very hot. Let the machine cool completely before touching the back.

Warning!



This appliance must be properly grounded.

Important safety instructions

Grounding instructions

A) Grounding instructions for a grounded, cord-connected appliance

In the event of malfunction or breakdown, grounding will reduce the risk of electric shock by providing a path of least resistance for electric current. This appliance (Canadian market only) is equipped with a cord having an equipment-grounding conductor and a grounding plug. The plug must be plugged into an appropriate outlet that is properly installed and grounded in accordance with all local codes and ordinances.

Warning!



Improper connection of the equipment-grounding conductor can result in a risk of electric shock. Check with a qualified electrician or service representative or personnel if you are in doubt as to whether the appliance is properly grounded. Do not modify the plug provided with the appliance (Canadian market only). If it will not fit the outlet, have a proper outlet installed by a qualified electrician.

To reduce the risk of fire, this appliance must be exhausted outdoors or the equivalent. Do not exhaust into a chimney, wall, ceiling or concealed space in a building.

B) Grounding instructions for a permanently connected appliance:

This appliance must be connected to a grounded metal, permanent wiring system, or an equipment-grounding conductor must be run with the circuit conductors and connected to the equipment-grounding terminal or lead on the appliance.

Note

This manual does not cover every possible condition and situation that may occur. Use common sense and caution when installing, operating, and maintaining any appliance.

Interrupting a program

You can stop a drying program by:

- Opening the door. The drum will then stop automatically.
- Pressing the main power switch.
- Press the Stop button for three seconds.

When you want to resume tumble drying, simply close the door and press the Start button.

Transport/Winter storage

If you need to move your machine or store it over the winter in unheated premises, make sure you drain the condensed water container beforehand.

Packing material

Please sort waste materials in accordance with local guidelines.

Disposal

This machine is manufactured and labeled for recycling. In order to prevent injuries, the machine must be made unusable once the decision has been made to dispose of it. Contact your municipality for information about where and how your machine can be recycled correctly.

Save these instructions for future reference

Child safety

General

Do not allow children to play with the tumble dryer.



The tumble dryer does not start automatically when the door closes (for example, if a child closes the door from inside the dryer). In order to prevent children from starting a program or changing one that has already started, you can activate the Child-safe Start option.

Activating Child-safe Start

You can activate Child-safe Start to prevent children from starting the machine.

1. Press the program selector until Child-safe Start is highlighted.
2. Turn the program selector until On or Off is displayed.
3. Press the program selector to activate

To temporarily deactivate Child-safe Start:

Pressing the program selector and the Stop button at the same time for three seconds will temporarily disable the safety catch for three minutes.

Description of the tumble dryer

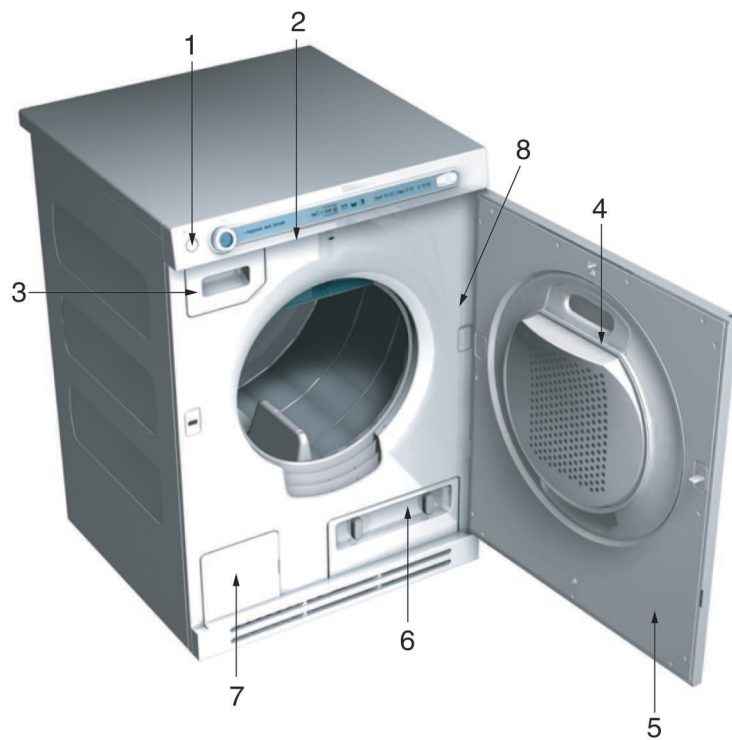

- 1. Main power switch
- 2. Panel
- 3. Condensed water container
- 4. Lint filter holder
- 5. Outer door

- 6. Condenser
- 7. Fan (behind hatch)
- 8. Serial number tag and rating plate
- 9. Lint filter

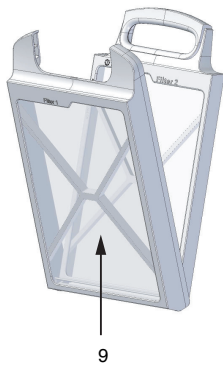

Front panel

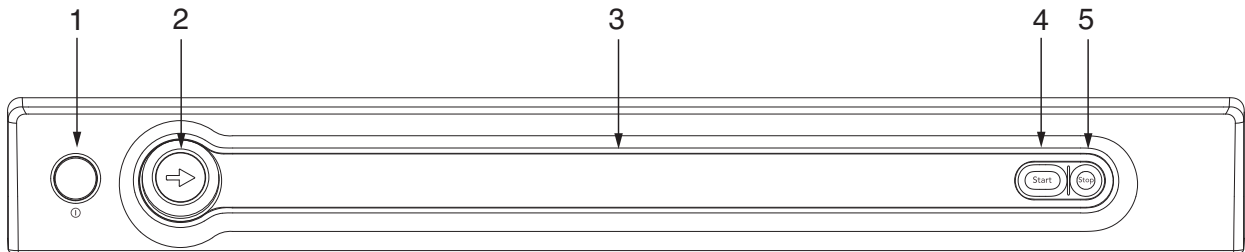

- 1 Main power switch
- 2 Program selector
- 3 Display window

- 4 Start
- 5 Stop

Advice and tips before you tumble dry

Here are some tips that may help you before you begin tumble drying.

Have the clothes been spun?

Items to be tumble dried should be spun at 1000 rpm or faster. Higher spin speeds save both energy and drying time.

Materials that can be tumble dried

 This symbol means that the material is suitable for tumble drying. Fabrics best suited to tumble drying are cotton fabrics, terry cloth, and synthetic fibers. Garments will be softer and lighter when tumbled than when hung out to dry.

Note!

The tumble dryer does not cause any significant wear to fabrics. The lint trapped in the lint filter consists of dust and fiber residues which gather when the items are used.

Materials that should not be tumble dried

 This symbol means that the material is not suitable for tumble drying. Certain materials may melt or become a fire hazard if exposed to heat and others can lose their shape or shrink.

And do not tumble dry

- materials labeled "Do not dry near heat".
- garments that have been dry-cleaned at home.
- plastic foam.
- fiberglass material.
- wool must not be tumble dried due to the risk of piling.

Static electricity

To reduce the risk of static electricity in the laundry after tumble drying, you can:

- Use fabric softener when washing.
- Wait five minutes after the drying program ends before opening the door and removing the laundry from the dryer.

Note!

If the door is opened during the program, the program will be interrupted and will return to the start. The clothes may be too damp or too dry as a result.

Operating instructions

Warning!



To reduce the risk of electric shock or injury to persons, read the "Important Safety Instructions" section before operating this appliance.

Below are step-by-step instructions to help you achieve the best possible tumble drying results.

1 Sort your fabrics

You will achieve the most uniform drying results if the items are made of the same type of material. Close zippers and fasten buttons or belts; sort the items and adjust load and temperature.

2 Turn on the main power switch.

3 Open the door, load the items, and then close the door

4 Select the program

You select a program by turning the program selector. The name of the selected program is highlighted and the program end time also appears on the display. Start the program by pressing the Start button, or press the button in the middle of the program selector to select Options.

Guidelines as to what specific programs can be used for.

Auto Heavy

This program is for items that are particularly difficult to dry.

Note!

Knitted fabrics in particular are prone to shrinkage. Use the Auto Normal, Auto Delicate, or Auto Iron Dry programs for these items. Stretch clothes back into shape immediately after drying.

Auto Normal and Auto Delicate

These programs shut off the heat once the load is dry but before it is "bone-dry". The Auto Normal program shuts off the heat slightly later than Auto Delicate. Use trial and error to find out what works best. Use these programs when you want items to be completely dry.

Auto Iron Dry

This program shuts off the heat once the load is just damp enough for ironing or pressing.

Jeans

Program for jeans and clothing with very thick seams. Delayed Start can be selected as an option.

Synthetic

Gentle program for synthetics. Delayed Start can be selected as an option.

Timed Dry

The program length you choose depends on what you intend to do with the items after drying them. Use trial and error to find out what works best. When you use Timed Dry to tumble dry a load of mixed fabrics, some of the garments may remain damp. Tumble dry any damp garments for a further 30 minutes or so using the Timed Dry program.

Note!

When using the Timed Dry program, garments can become "over-dry" if you have selected too long a drying time. This can cause the items to shrink or wrinkle and become rough. Synthetic materials can also become charged with static electricity.

Setting the time for the Air Fluff or Timed Dry program

For the Air Fluff and Timed Dry programs, you set the number of minutes incrementally. The selected time is shown on the display. You can try out different drying times.

Operating instructions

Air Fluff

Use the Air Fluff program when you just want to refresh, air out,, or soften up items.

Operating instructions

Menu overview

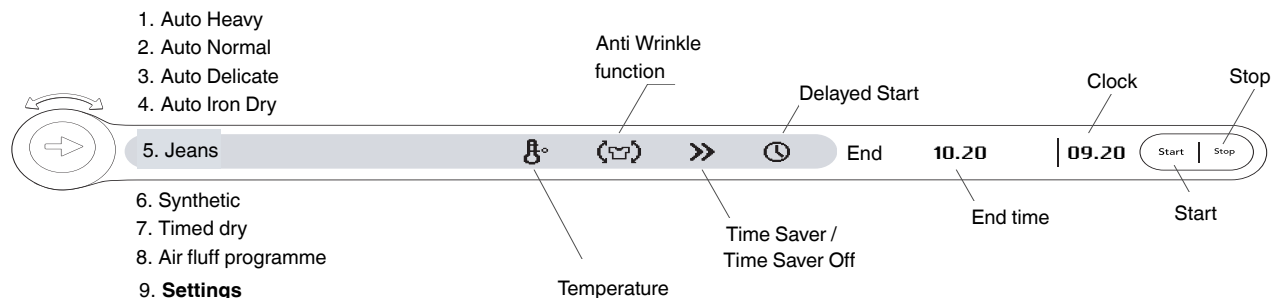

Temperature Normal



Temperature Low



Time Saver



Time Saver Off

Note!

The illustration shows an example of a program.

Program chart

Here we present a few examples of the energy and time consumption of a few different program settings. Consumption can vary due to room temperature, humidity, load, variations in the power supply, and selected options

For the consumption values given below, the requirements are as follows:

Temperature of intake air:	73°F (23°C)
Moisture content of intake air:	55 %
Drying temperature:	Normal or Low
Heater output:	2500W

Program chart

Program	Material	Temperature	Max. load (lb)	Energy consumption (approx. kWh)		Program time (approx. hrs and min.)	
				800 rpm	1600 rpm	800 rpm	1600 rpm
Auto Heavy	Cotton, linen	Normal	13	4.7	3.8	1:55	1:35
Auto Normal	Cotton, linen	Normal	13	4.1	3.2	1:40	1:20
Auto Normal	Wrinkle-resistant, polyester/cotton	Normal	7	1.8	-	0:45	-
Auto Delicate	Cotton, linen ¹⁾	Normal	13	3.9	2.9	1:35	1:10
Auto Delicate	Wrinkle-resistant, polyester/cotton	Normal	7	1.7	-	0:40	-
Auto Delicate	Acrylic, rayon, acetate	Low	7	2.1	-	1:20	-
Auto Iron Dry	Cotton, linen	Normal	13	2.9	2.2	1:25	1:10

Operating instructions

5 Selecting Options

By selecting options, you can tailor drying programs to suit your own laundry requirements. The machine remembers the selected option and uses it the next time you select the same program. You can, of course, change this if you want.

Temperature

1. Select the temperature by pressing the program selector until Temperature is highlighted.
2. Turn the program selector clockwise until Normal Temperature is displayed or counterclockwise until Low Temperature is displayed.
3. Press the Start button to start the program or press the program selector to select more options.

Time Saver

You can choose Time Saver with all programs except Air Fluff. The program is shortened by about 12 minutes.

1. Press the program selector until "Time Saver" is highlighted.
2. Turn the program selector clockwise until "Time Saver" is displayed or counterclockwise until "Time Saver Off" is displayed.
3. Press the Start button to start the program or press the program selector to select more options.

Anti Wrinkle

This is a useful feature if you cannot take the laundry out as soon as the tumble dryer has finished. The function prevents the clothes from remaining in the same position and becoming wrinkled. The drum will rotate for three seconds per minute for two hours once the drying program has finished

1. Choose Anti Wrinkle by pressing the program selector until Anti Wrinkle is highlighted.
2. Turn the program selector clockwise to select On or counterclockwise to select Off.
3. Press the Start button to start the program or press the program selector to select more options.

Delayed Start

Choose the number of hours by which you want to delay the start.

1. This option cannot be used with the Air Fluff and Timed Dry programs.
2. Select Delayed Start by pressing the program selector until Delayed Start is displayed.
3. Turn the program selector to the number of hours by which you want to delay the start.
4. Press the Start button to start the program or press the program selector to select more options.

Note!

Remember to press the Start button.

Setting the time for the Timed Dry and Air Fluff programs

You can set the time so that it appears on the display as Start, End, or the number of minutes. This will depend on how you have chosen to display times.

1. Press the program selector until the Time setting is highlighted.
2. Turn the program selector to select the time in 15 minute intervals.
3. Press the Start button to start the program or press the program selector to select more options.

Operating instructions

6 Press the Start button

Remaining drying time

An estimate of the remaining drying time will be shown on the display a few minutes after the drying program starts. For example, 1:35 means it will take approximately 1 hour and 35 minutes for the load to dry. If the Anti Wrinkle option has been selected, the drum will rotate for 3 seconds every minute for 2 hours after the program is finished.

Stopping or changing a program

Press and hold the Stop button for three seconds.

Note!

The program will not be affected if you change the program selector after the program has started.

Loading or removing laundry

You can stop the tumble dryer after starting a program by opening the door. Load more laundry or take out the items you want, close the door, and press the Start button. A new estimate of the remaining program time will be displayed after a few minutes.

7 Drying program finished

The text "END" appears on the display when the program is finished. If the Anti Wrinkle option has been selected, the drum will rotate for 3 seconds every minute for 2 hours after the program is finished.

Important!

- Clean the lint filter after each load.

Caution!



If the lint filter becomes clogged, the machine's automatic overheating cut-off may be triggered. In order to be able to restart the machine, you must clean the filter and allow the machine to cool down for around 30 minutes.

Cleaning the lint filter

1. Grasp the filter handle and pull it toward you.
2. Pull the filter out of its holder.

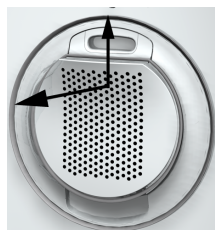

3. Open the filter and remove the lint by hand.

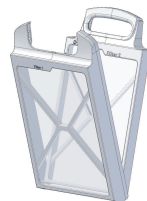

4. Fold the filter up and insert it into its holder. The filter may need to be cleaned if it has limescale deposits. See the "Care and cleaning" chapter.

Operating instructions

To install the automatic drain hose, please see the section titled Installation

8 **Once drying has finished**
Turn off the main power switch. Remove the clothes and close the door to prevent small children from climbing into the machine.

Settings

You can alter the following settings:

- Clock
- Buzzer Volume
- Language
- Child-safe Start
- Back

How to choose the settings:

1. Press the program selector until the program selection menu on the left is highlighted.
2. Turn the program selector until Settings is highlighted.
3. Press the program selector.

Clock

Set to 12/24 hour or remaining program time display.

1. Press the program selector button until Clock appears in the middle of the display.
2. Press the program selector again to access the options menu on the right of the display.
3. Turn the program selector to choose whether 12h, 24h, or remaining program time is displayed.
4. Press the program selector to save your setting.
5. Once you have selected the 12 or 24 hour clock, you will automatically enter the clock setting menu.

Setting the clock

6. Turn the program selector until the correct hour is shown.
7. Press the program selector to save your setting.
8. Turn the program selector until the correct minutes are shown.
9. Press the program selector to save your setting.
10. If you do not want to select any more settings, turn the program selector counterclockwise to the program you want.

Buzzer Volume

You can choose to have the machine notify you when a program has finished or when a fault has occurred.

1. Select Buzzer Volume by turning the program selector until Buzzer Volume is highlighted.
2. Press the program selector again to access the options menu on the right of the display.
3. By turning the program selector you can select the setting for the Buzzer Volume: Off, Low, Normal, High.
4. Press the program selector to save your setting.

Language

You can choose the language you prefer.

1. Select Language by turning the program selector until Language is highlighted.
2. Press the program selector again to access the options menu on the right of the display.
3. Turn the program selector to choose from: US English, English, Svenska, Dansk, Norsk, Suomi, Francais, Nederlands, Italiano, Espanol, Русский, Deutsch.
4. Press the program selector to save your setting.

Settings

Child-safe Start

You can activate the Child-safe Start option to prevent children from starting the machine. Pressing the program selector and the Stop button at the same time for three seconds will temporarily disable the Child-safe Start option for three minutes.

1. Select Child-safe Start by turning the program selector until Child-safe Start is highlighted.
2. Press the program selector again to access the options menu on the right of the display.
3. Turn the program selector clockwise to choose "On" or counterclockwise to choose "Off".
4. Press the program selector to activate

Care and maintenance instructions

Cleaning the lint filter

The lint filter must be cleaned after each load. If you have very hard water, this can cause limescale deposits in the lint filter. Check for any limescale deposits when cleaning the lint filter and, if necessary, wash the filter by hand. Additionally, the filter should be cleaned with hot water, detergent, and a soft brush quarterly.

1. Grasp the filter handle and pull it toward you.
2. Pull the filter out of its holder.



3. Open the filter and remove the lint from all sides of it by hand. Use a soft, dry cloth to remove any deposits.

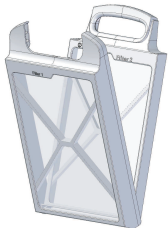

4. Replace the filter in its holder.

Note!

If you have hard water, the filter should be washed with water to remove any limescale deposits. Use a sponge and a little dishwashing detergent if necessary. Dry the filter carefully with a towel. If you cannot remove the limescale, you can buy a new filter from the retailer where you bought the tumble dryer.

Cleaning the outside of the machine

Clean the outside of the machine and the program panel with a mild cleaner. Do not use solvents, as these can damage the machine. Do not hose down or spray the machine with water.

Note!

Do not allow dust to accumulate around the machine. Keep the area around the tumble dryer clean and cool; dust, heat, and moisture prolong drying times.

Care and maintenance instructions

Cleaning the condenser

The condenser should be cleaned at least three times a year. If you have pets, the condenser must be cleaned more frequently.

1. Turn off the main power switch.
2. Replace the lower plinth.

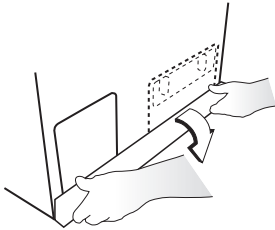

3. Open the condenser panel by turning the two knobs counterclockwise.

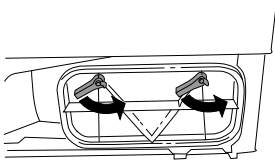

4. Remove the condenser and rinse the coils clean, using a hand-held shower, for example. Do not touch the lamella springs, as you may damage the condenser. Do not use pointed metal objects during cleaning.

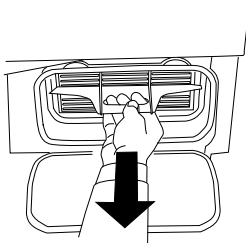

Note!

Do not put the condenser in a dishwasher.

5. Replace the condenser. When refitting the condenser, check that it is replaced correctly. The top of the condenser is labeled "upp", "up", and "oben".

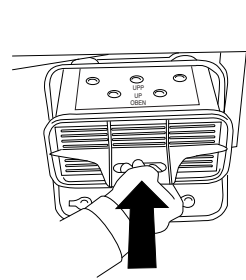

6. Before you replace the plinth, clean the filter from the plinth's air gaps with a soft cloth.
7. Replace the plinth.

Troubleshooting

The machine will not start

Check

- that the door is properly closed.
- that the main power switch is on.
- that the Delayed Start option has not been selected. To cancel Delayed Start, press the Stop button for 3 seconds.
- that any plug is connected.
- that the fuses (circuit breakers) in your house are intact. Flip the dryer breaker off and then back on to make sure. You can not always tell from the outside if the circuit breaker has tripped.
- that the overheating cut-off has not been triggered (see below).

Overheating cut-off

The overheating cut-off shuts off the tumble dryer if the temperature is too high, caused by lint clogging the lint filter, for instance.

- Clean the filter.
- Check that the condenser is clean. Clean it if necessary. See the "Care and cleaning" chapter.
- The overheating cut-off will reset automatically once the machine has cooled down.

Drying takes too long

- Check that the lint filter and the condenser are not blocked. See the "Care and maintenance" chapter.
- Prolonged drying times may also be due to the tumble dryer being located in a confined space or room that is too small, causing the air to become too hot.
- Make sure that the tumble dryer has access to more cold air, by opening doors and/or windows, for example.

The laundry does not dry, or is too dry

- The door has been opened while the program is running, which disrupts the moisture monitoring function.

Error messages

- If Overflow is shown in the display, the condenser drain hose could be blocked. Remove the hose from the drain and check for obstructions. The hose should be inserted no more than 5 or 6 inches into the wall drain.
- If "Max Program Time" appears on the display, the maximum program time has been reached. Read "Drying takes too long" in the "Troubleshooting" chapter to find out what to do.
- If "Clean lint filter" appears on the display, clean the lint filter.
- If "Clean condenser" appears on the display. See the "Cleaning the condenser" section of the "Care and cleaning" chapter for remedy
- Press the Stop button to close error messages.

Technical information

Technical data

Height:	33 1/2" (850mm)
Width:	23 7/16" (595mm)
Depth:	23,0" (585mm)
Weight:	104lb (47kg)
Cylinder volume:	29,3gal (111l)
Max. drying capacity:	13lb (6kg)
Speed:	52 rpm
Rated power:	See serial number tag and rating plate.
Drum material:	Stainless steel
Outer casing material:	Powder-coated and hot-galvanized sheet steel or stainless steel.
Setup	Stacking or freestanding
Drain:	67" (1.7m) polypropylene hose 79" (2.0m) rubber hose

Service and guarantee

It is important to register your product warranty by logging onto www.askousa.com/customer-care/registration and filling out all required fields within 90 days from the date of purchase. After doing so, you will be e-mailed a certificate that will extend the original warranty for one additional year. If you do not have access to the internet, complete the warranty card included with the product and mail it to the address on the warranty card within 90 days of the date of purchase. Cosmetic damage must be reported to your dealer within five days from the date of purchase. After unpacking the washer, thoroughly check the unit for cosmetic damage.

For residential installations only	ASKO Appliances Inc. will pay for:
Length of warranty Two-Year Full From date of purchase.	ASKO replacement parts and/or repair labor to correct defect in materials or workmanship. Service must be provided by an authorized ASKO service agent.
Third Year Full Complete your product warranty registration online at www.askousa.com/customer-care/registration within 90 days from the date of purchase to extend the original warranty one additional year. If you do not have access to the internet, complete the warranty card included with the product and mail it to the address on the warranty card within 90 days of the date of purchase.	ASKO replacement parts and/or repair labor to correct defect in materials or workmanship. Service must be performed by an authorized ASKO service agent.
Lifetime	ASKO replacement parts (labor cost not included) for the stainless steel tank if it exhibits a manufacturing defect such as cracking or rusting through. Service must be provided by an authorized ASKO service agent.
For non-residential installations One-year Full Warranty From date of purchase.	ASKO replacement parts and/or repair labor to correct defect in materials or workmanship. Service must be provided by an authorized ASKO service agent.

Service and guarantee

Warranty

ASKO Appliances Inc. will not pay for:

Service calls to:

1. Correct the installation of the appliance.
 2. Repair damage due to shipment, delivery, installation, misuse or abuse.
 3. Instruct how to use the appliance.
 4. Replace house fuses or correct house wiring.
 5. Correct house plumbing, including drainage problems related to improper installation.
 6. Clean or service air device in drain line.
- Repair and/or replacement parts for failure of product if appliance is used for other than home/residential use.
 - Damage resulting from accident, fire, floods, acts of God, alteration, misuse, abuse, improper installation, or installation not in accordance with local electrical or plumbing codes.
 - Any shipping costs for parts during the limited warranty period.
 - Replacement parts or repair labor costs for units operated outside the continental United States.
 - Pickup and delivery. ASKO washers are designed to be repaired in the home.

In no event shall ASKO Appliances Inc. be responsible for any incidental or consequential damages.

Some states will not allow the exclusion or limitation of incidental or consequential damages, so this exclusion or limitation may not apply to you. This warranty gives you specific legal rights and you may also have other rights which vary from state to state.

For warranty service, contact our Customer Care Center at the number listed below.

Before calling for service or contacting ASKO Appliances Inc. regarding a warranty issue, make a note of the model, type name, and serial number.

How to contact the ASKO Appliances Inc.

Write to us at:

ASKO Appliances Inc.

P.O. Box 940609

Plano, TX 75094-0609

www.askousa.com

Or contact our

Customer Care Center at

1-800-898-1879

www.askousa.com

Installation instructions

WARNING!



WARNING - Risk of fire.

Install the clothes dryer according to the manufacturer's instructions and local codes.

Do not install a clothes dryer with flexible plastic venting materials. If flexible metal (foil type) duct is installed, it must be of a specific type identified by the appliance manufacturer as suitable for use with clothes dryers. Flexible venting materials are known to collapse, be easily crushed, and trap lint. These conditions will obstruct clothes dryer airflow and increase the risk of fire.

To reduce the risk of severe injury or death, follow all installation instructions.

Save these instructions for future reference.

Positioning the tumble dryer

The tumble dryer can be freestanding or stacked. Remember that the tumble dryer produces heat and should therefore not be located in a room that is too small. If the room is very small, drying will take longer due to the limited quantity of air.

Caution!

For proper ventilation, the machine should not be installed behind a door.

Caution!



The tumble dryer's toe kick ventilation must not be blocked by a rug or the like.

Tip!

If the unit must be installed behind a door should be louvered. To improve ventilation, the door where the tumble dryer is located should be left open when the dryer is in use.

Caution!

Clothes dryer installation must be performed by a qualified installer.

A. Freestanding

The tumble dryer can be positioned beside the washing machine.

B. Stacked

The tumble dryer can be placed on top of a ASKO washing machine. To stack the dryer, you need the stacking attachments (foot cups and anti-tip devices) that come with the machine: You will find 2 foot cups in a bag in the drum and 2 anti-tip devices attached to the bottom left corner at the back of the machine. Extension plates can be ordered from your local retailer.

Installation instructions

C. Built-in

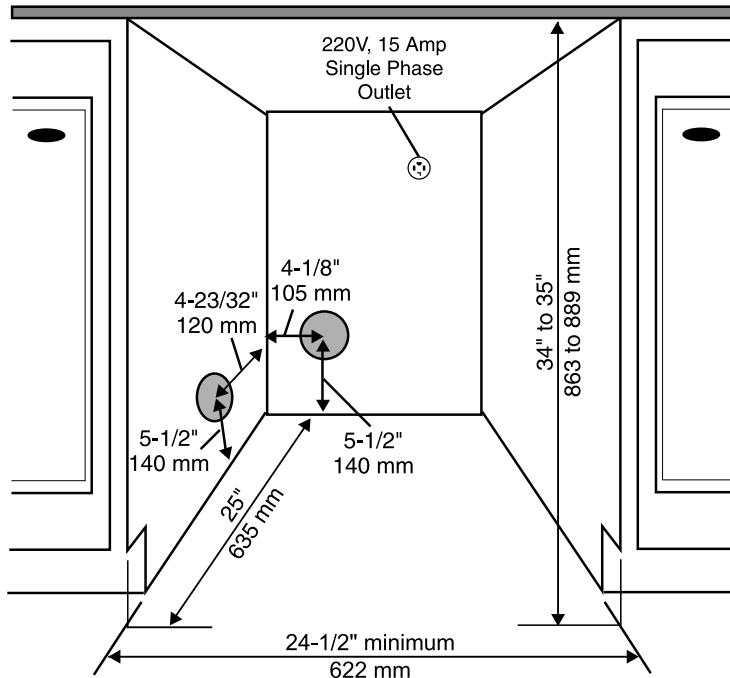

ASKO dryers can be installed beneath a cabinet or worktop with a minimum height of 34" (864 mm). There must be a gap of about 1/2" (12 mm) all around the machine, including between the rear edge of the machine top panel and the back wall. The opening width must be at least 24-1/2" (622 mm). The condensing models work best when they have good air circulation. Install the dryer so the condensed water will continuously flow into a drain or sink, you will need a drain outlet behind the unit. The maximum drain height is 40" (1016 mm).

Notes

The height adjustment for the dryer is 33-1/2" to 34-1/2" (850 mm to 876 mm). Do not raise it higher than 34-1/2" (876 mm). Hole measurements are from center of hole.

Installation instructions

How to assemble the stacking kit:

1. Undo the anti-tip device.

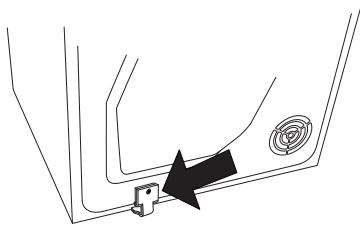

2. Remove the two screws indicated on the back of the washing machine.

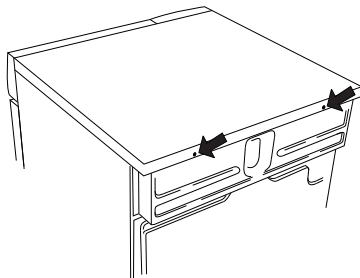

3. Secure the anti-tip device using the screws as shown in the picture.

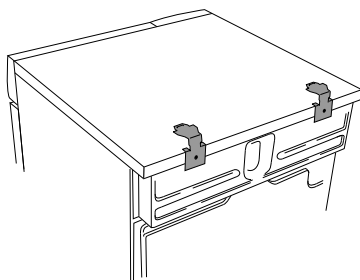

4. Attach the plastic cups for mounting the tumble dryer's front feet to the washing machine's top cover. This is essential, as only when the tumble dryer's feet are resting in the plastic cups can you be sure that the dryer is correctly positioned on the washing machine.

Break off tab A on the cup fitted on the right side and tab B on the cup fitted on the left side. Then remove the paper from the self-adhesive surface under the plastic cups.

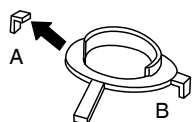

5. Fit the plastic cups so that the "tags" marked with arrows are against the front edge or side edge of the cover and press them firmly onto the cover. Then break off the remaining tabs.

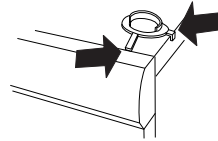

6. Push out the knock-out hole on the back of the dryer (you don't have to completely remove the knockout, just fold it up far enough for the stacking bracket to fit inside the slot) using a hammer and screwdriver.

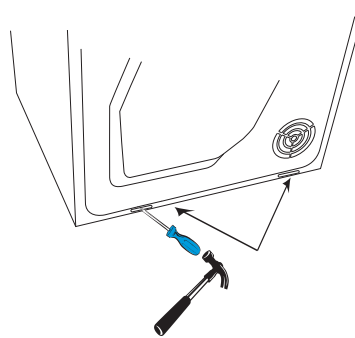

7. Push the tumble dryer in under the metal brackets. At the same time, keep the front edge raised by 0,4" (10mm) to 0,8" (20mm).

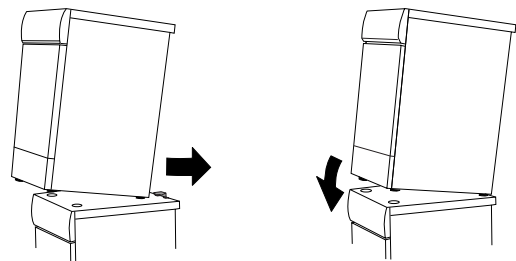

8. Lower the tumble dryer's front feet into the plastic cups and adjust the dryer to ensure that it is balanced.

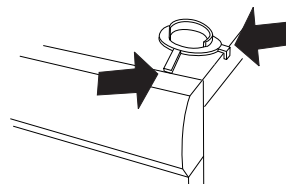

Installation instructions

Adjusting the feet

Screw the feet in or out so that the tumble dryer is steady and balanced on the floor or on the washing machine. Then tighten the lock nuts.

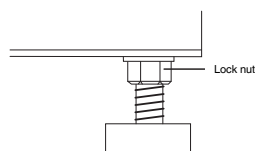

Condensed water

Install the dryer so the condensed water will continuously flow into a drain or sink. To do this, follow the instructions below:

1. Disconnect the short hose (1) from the blue connection. (It's okay to let the hose hang down.)
2. Connect the rubber hose supplied with the dryer to the blue nipple (2).
3. Run the hose to a drain or sink, as illustrated (3).

Note

The drain hose must not be more than 40" above the floor.

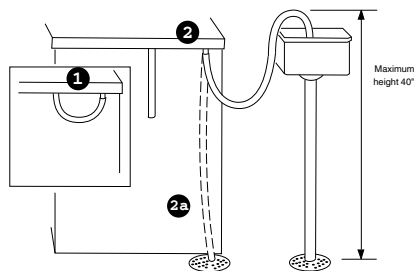

Electrical installation

Warning!



The receptacle on the rear of the machine is designed to accommodate ASKO washers ONLY (rated 208–240 V.) To use this receptacle, you must use the ready-fitted plug supplied with the washing machine or an equivalent.

ASKO washers rated 208–240 V have two internal fuses of 15 A each.

The machine should only be connected to a grounded wall socket.

Warning!



This appliance must be properly grounded. Refer to the "Important Safety Instructions" for grounding instructions.

The power supply cord must be grounded. If the machine is to be used in a wet area, the supply must be protected by a residual current device.

Connection to a permanently wired supply point must be made only by a qualified electrician. As supplied: Single-phase, 230 V, 60 Hz, 2500W heater rating 30 A circuit required

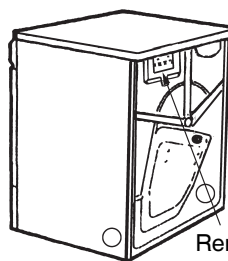

Remove cover to access terminal box. (Requires a 20-Torx screwdriver.)

Installation instructions

Electrical Connections

Warning!



Read the Electrical requirements and grounding instructions before connecting the tumble dryer.

Electric models of the dryer are manufactured for a 3-wire connection system. The dryer frame is grounded by a link to the neutral conductor on the dryer terminal block. If local codes do not permit grounding through the neutral, the grounding link from the terminal block must be removed and a separate ground wire must be used.

Only a 4-conductor cord shall be used when the appliance is installed in a location where grounding through the neutral conductor is prohibited. Grounding through the neutral conductor is prohibited for new branch-circuit installations, mobile homes, recreational vehicles, and areas where local codes prohibit grounding through the neutral conductors. The grounding link on the dryer must be removed for all 4-wire installations.

These Electrical Connection instructions provide for installing the dryer in the following situations:

3-wire connection where local codes permit grounding through the neutral. 3-wire connection plus separate grounding connector where local codes do not permit grounding through the neutral.

4-wire connection.

Each of the above connections can be made with an approved power supply cord or by direct wiring. Each connection instruction identifies the appropriate Power Supply Cord and covers requirements for direct wiring.

Note

In Canada, the dryer is delivered ready-fitted with a four-prong plug intended for connection to a single-phase supply.

Connecting a 3-wire Power Cord

Warning!



Before starting this procedure, be sure the power is turned off at the breaker/fuse box.

3-Wire Cord

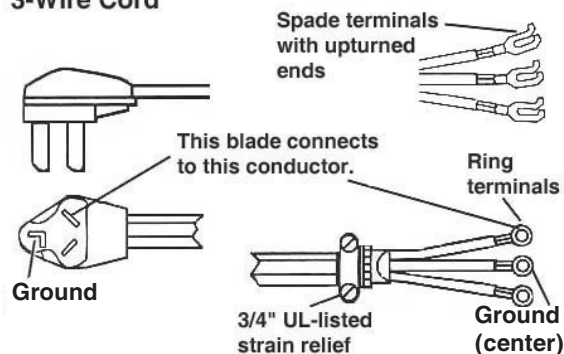

Power Supply Cord

You will need a 3-wire power supply cord with three No. 10 copper wires and a matching 3-wire receptacle of NEMA Type 10-30R, as illustrated below:

To connect a 3-wire power cord to the dryer, follow the steps below.

Note

The numbers in the illustration below correlate to the step numbers.

1. Turn the power off at the breaker or fuse box.
2. Remove terminal block cover.
3. Use the strain relief attached below the terminal block opening.
4. Loosen or remove center terminal block screw.

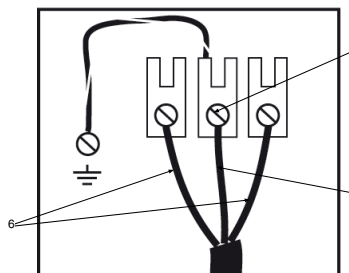

Installation instructions

5. Connect ground (center) wire of power supply cord to the center, silver-colored terminal screw. Tighten screw.
6. Connect the other wires to outer screws.
7. Tighten the strain relief screws.
8. Replace terminal box cover on back of dryer.
9. Plug dryer into wall receptacle.
10. Turn power on at breaker/fuse box.

Connecting a 4-wire Power Cord

Warning!



Before starting this procedure, be sure the power is turned off at the breaker/fuse box.

4-WIRE CORD

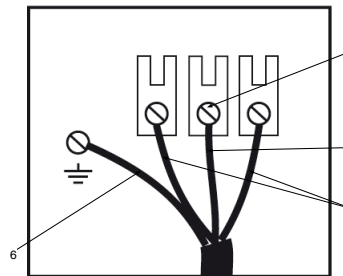
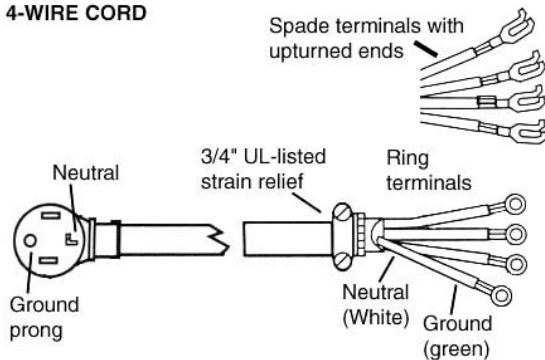

5. Remove ground wire (green with yellow stripes) from external ground connector screw and remove from center terminal block.
6. Connect ground (green) wire of cord to external ground conductor screw.
7. Connect neutral (white) wire of cord under center screw of terminal block.
8. Connect the other wires to outer screws.
9. Tighten the strain relief screws.
10. Replace terminal box cover on back of dryer.
11. Plug dryer into wall receptacle.
12. Turn power on at breaker/fuse box.

Power Supply Cord

You will need a 4-wire power supply cord with four No. 10 copper wires and a matching 4-wire receptacle of NEMA Type 14-30R, as illustrated below.

The fourth wire must be identified with a white cover and the ground conductor by a green cover.

To connect a 4-wire power cord to the dryer, follow the steps below.

Note

The numbers in the illustration below correlate to the step numbers.

1. Turn the power off at the breaker/fuse box.
2. Remove terminal block cover.
3. Use the strain relief attached below the terminal block opening.
4. Remove center terminal block screw.

Reversing the door



- | | |
|---|-------------------------------|
| 1. Hinge pins (top and bottom) | 4. Lock hook |
| 2. Cover washer | 5. Hinges (left + right side) |
| 3. Plastic plugs (on the upper and lower edges) | 6. Toe kick |

Reversing the door

You can choose whether the door is hung on the right or the left.

Follow these instructions:

1. Remove the Toe kick.
2. Unscrew the 2 screws on the hinges.



3. Lift the door up and remove it. Support the door while doing this.
4. Remove both door pins (top and bottom). Fit them on the opposite side of the door. Refit the hinges.

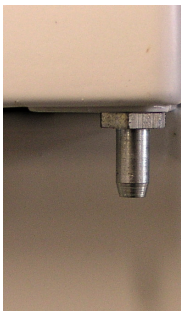

5. Undo and remove the lock hook (lift up and pull out) and the cover washer from the door and the machine. Fit the hook and the washer on the other side.



6. Move the plastic plugs on the upper and lower edges of the door. Use a flat screwdriver to remove the plugs.



7. Refit the door by loosening the hinge screws slightly, affixing the door, and closing it. Retighten the hinges. Replace the Toe kick.

Notes

Notes

Notes

Quick guide

1 Fabrics

- Dry fabrics of the same type together to ensure they dry as evenly as possible.

2 Turn on the main power switch

3 Load the laundry

- Close the door.

4 Select a program and any options

- Turn the program selector to the desired program.
- Select any options and settings.

5 Press the Start button

6 Drying program finished

- "END" appears on the display when the program is finished. If the Anti Wrinkle option has been selected, the drum will rotate for 3 seconds every minute for 2 hours after the program is finished.
- Clean the lint filter after each load.

7 Once tumble drying has finished

- Turn off the main power switch and close the door.

Program chart

Program	Material	Temperature	Max. load (lb)	Energy consumption (approx. kWh)		Program time (approx. hrs and min.)	
				800 rpm	1600 rpm	800 rpm	1600 rpm
Auto Heavy	Cotton, linen	Normal	13	4.7	3.8	1:55	1:35
Auto Normal	Cotton, linen	Normal	13	4.1	3.2	1:40	1:20
Auto Normal	Wrinkle-resistant, polyester/cotton	Normal	7	1.8	-	0:45	-
Auto Delicate	Cotton, linen ¹⁾	Normal	13	3.9	2.9	1:35	1:10
Auto Delicate	Wrinkle-resistant, polyester/cotton	Normal	7	1.7	-	0:40	-
Auto Delicate	Acrylic, rayon, acetate	Low	7	2.1	-	1:20	-
Auto Iron Dry	Cotton, linen	Normal	13	2.9	2.2	1:25	1:10