

This Owner's Manual is provided and hosted by [Appliance Factory Parts](http://ApplianceFactoryParts.com).

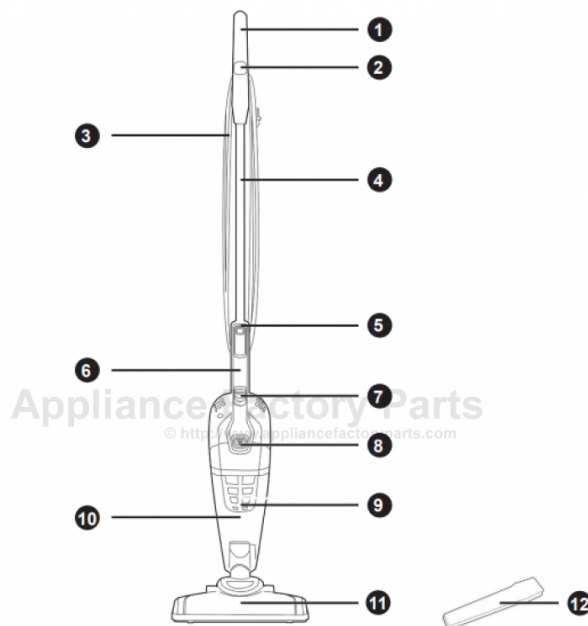

Black & Decker BDST1601 Owner's Manual

[Shop genuine replacement parts for Black & Decker
BDST1601](#)



- | | |
|-------------------------|----------------------------|
| 1. Hand Grip | 8. Dust Cup Latch |
| 2. Cord Wrap | 9. Filter |
| 3. Power Cord | 10. Dust Cup |
| 4. Handle | 11. Removable Floor Nozzle |
| 5. Quick Release Button | 12. Crevice Tool |
| 6. Hand Vacuum Grip | |
| 7. Power On/Off | |

[Find Your Black & Decker Vacuum Cleaner Parts - Select From 339 Models](#)

----- Manual continues below -----

BLACK+ DECKER™

3-IN-1 LIGHTWEIGHT STICK VACUUM CLEANER

INSTRUCTION MANUAL

MODEL NUMBERS
BDST1600 Series

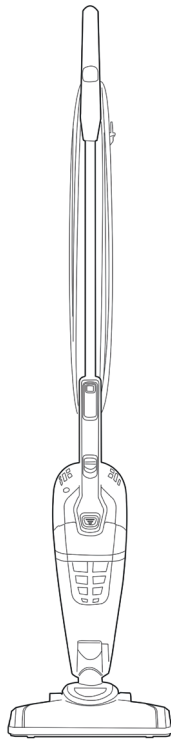

Thank you for choosing BLACK+DECKER!

PLEASE READ BEFORE RETURNING THIS PRODUCT FOR ANY REASON.

If you have a question or experience a problem with your BLACK+DECKER purchase, call 1-800-524-6716 from 9 a.m. to 5 p.m. EST Mon. - Fri. to speak with an agent.

Please have the model number available when you call.

SAVE THIS MANUAL FOR FUTURE REFERENCE.

To register your new product, visit
www.BlackandDecker.com

IMPORTANT SAFETY INSTRUCTION

SAFETY GUIDELINES - DEFINITIONS

It is important for you to read and understand this manual.

The information it contains relates to protecting YOUR SAFETY and PREVENTING PROBLEMS. The symbols below are used to help you recognize this information.

⚠ DANGER: Indicates an imminently hazardous situation which, if not avoided, will result in death or serious injury.

⚠ WARNING: To avoid all risks of fire, electrocution or injury, when using an electrical appliance, make sure you follow the safety measure below:

READ CAREFULLY ALL THE RECOMMENDATIONS BEFORE USING YOUR VACUUM CLEANER

⚠ CAUTION: Indicates a potentially hazardous situation which, if not avoided, may result in minor or moderate injury.

NOTICE: Used without the safety alert symbol indicates potentially hazardous situation which, if not avoided, may result in property damage.

When using an electrical appliance, basic precautions should always be followed, including the following:

READ ALL INSTRUCTIONS BEFORE USING THE APPLIANCE.

⚠ WARNING: Before using this appliance, read and follow all warnings and instructions in this manual, even if you are familiar with this product.

This appliance is not intended for use by persons (including children) with reduced physical, sensory or mental capabilities, or lack of experience and knowledge, unless they have been given supervision or instruction concerning use of the appliance by a person responsible for their safety. Young children should be supervised to ensure that they do not play with the appliance.

POLARIZATION INSTRUCTION

To reduce the risk of electric shock, this appliance has a polarized plug (one blade is wider than the other). This plug will fit in a polarized outlet only one way. If the plug does not fit fully in the outlet, reverse the plug. If it still does not fit, contact a qualified electrician to install the proper outlet. Do not change the plug in any way.

Safety Direction

Please read this instruction manual carefully before first use. It is advisable to keep this instruction manual for future reference.

DO NOT vacuum water, wet objects, liquids, ashes, hot coals, cigarette butts, matches or any hot, smoking or burning objects, etc.

DO NOT pick up flammable or combustible materials (i.e. lighter fluid, petrol, kerosene, etc.) or use in the presence of explosive liquids or vapor.

DO NOT pick up toxic material (i.e. chlorine bleach, ammonia, drain cleaner, etc.)

DO NOT vacuum Toner (for laser printer, copy machines etc.) as there is a risk of fire and explosion.

DO NOT vacuum plaster, cement etc. as the filter can become blocked.

DO NOT use vacuum without all the filters fitted.

DO NOT store or use the appliance near high temperature areas.

DO NOT run over the power cord with the vacuum cleaner.

DO NOT use vacuum cleaner if it is blocked. Turn off and clear all blockages before continuing.

DO NOT use vacuum cleaner with blocked filters. Clean or replace filters before continuing. (refer to User Maintenance section).

DO NOT use vacuum cleaner if the appliance malfunctions, sounds abnormal, smells, smokes, is dropped or damaged in any manner or any breakage is found during operation.

DO NOT misuse the cord. Never pull the appliance by the cord or pull to disconnect it from the outlet. Instead, grasp the plug and pull to disconnect.

DO NOT use vacuum cleaner to pick up large, hard, or sharp objects such as glass, nails, screws, coins, etc. that are likely to cause damage.

DO NOT leave unattended when plugged in and/or switched on.

DO NOT use vacuum cleaner if it has been dropped, damaged, left outdoors, or dropped into liquid (water etc.)

DO NOT close door on cord, or pull cord around sharp edges or corners.

DO NOT handle the plug or vacuum cleaner with wet hands.

DO NOT put any objects into openings.

DO NOT use with any openings blocked and do not restrict airflow.

DO NOT operate the appliance with a damaged cord or plug. If the supply cord is damaged, it must be replaced by the manufacturer, its service agent or similarly qualified persons in order to avoid a hazard.

DO NOT use without filters in place.

DO NOT attempt to modify this product in any way.

DO empty the dust cup and clean the filters regularly for optimal operation of the vacuum.

DO keep hair, loose clothing, fingers, feet and body parts away from openings or moving parts.

DO disconnect the appliance from the mains supply before connecting the flexible suction hose.

DO turn off controls before you connect or disconnect the appliance to or from the mains supply.

DO disconnect the appliance from the power supply when not in use, before changing the filters, cleaning the filters or connecting/disconnecting the accessories.

DO use only on dry, indoor surfaces.

DO use only as described in this manual. Use only manufacturer's recommended attachments.

DO keep cord away from heated surfaces.

DO keep all openings free of dust, lint, hair, and anything that may reduce airflow.

DO use extra care when vacuuming on stairs.

DO keep your work area well lit.

DO store your appliance indoors in a cool, dry area.

DO ensure children and babies cannot play with plastic bags or any packaging materials.

DO operate the appliance from a power source of the same voltage, frequency and rating as indicated on the product identification plate.

If this appliance is used by a third party, **DO** supply the instruction manual with it. No liability can be accepted for any damage caused by non-compliance with these instructions or any other improper use or mishandling of appliance. This product has not been designed for any uses other than those specified in this manual.

DO NOT modify the polarized plug to fit a non-polarized outlet or extension cord. Keep appliance on a level surface.

ONLY for domestic use.

Industrial or commercial use invalidates the warranty.

IMPORTANT SAFETY INSTRUCTION CONT.

READ AND SAVE THESE INSTRUCTIONS

Symbols

- The labels on your tool may include the following symbols.

The symbols and their definitions are as follows:

- V volts
- A amperes
- Hz hertz
- W watts
- min minutes
- ~ or AC alternating current
- == or DC direct current
- n_0 no load speed
- ⓘ Class I Construction
- ⊕ earthing terminal (grounded)
- ⚠ safety alert symbol
- Ⓜ Class II Construction (double insulated)
- .../min or rpm revolutions or reciprocations per minute

- When using an extension cord, be sure to use one heavy enough to carry the current your product will draw. An undersized cord will cause a drop in line voltage resulting in loss of power and overheating.

The following table shows the correct size to use depending on cord length and nameplate ampere rating. If in doubt, use the next heavier gauge. The smaller the gauge number, the heavier the cord.

Volts	Minimum Gauge for Cord Sets				
	Total Length of Cord in Feet				
120V	0-25	26-50	51-100	101-150	
	(0-7,6m)	(7,6-15,2m)	(15,2-30,4m)	(30,4-45,7m)	
240V	0-50	51-100	101-200	201-300	
	(0-15,2m)	(15,2-30,4m)	(30,4-60,9m)	(60,9-91,4m)	
Ampere Rating					
More Than	Not more Than	American Wire Gauge			
0	- 6	18	16	16	14
6	- 10	18	16	14	12
10	- 12	16	16	14	12
12	- 16	14	12	Not Recommended	

Transporting your Vacuum

To move your vacuum cleaner from room to room, unplug the unit and either push the appliance or carry using the carry handle.

Never pull or carry the vacuum cleaner by its cord.

Product View

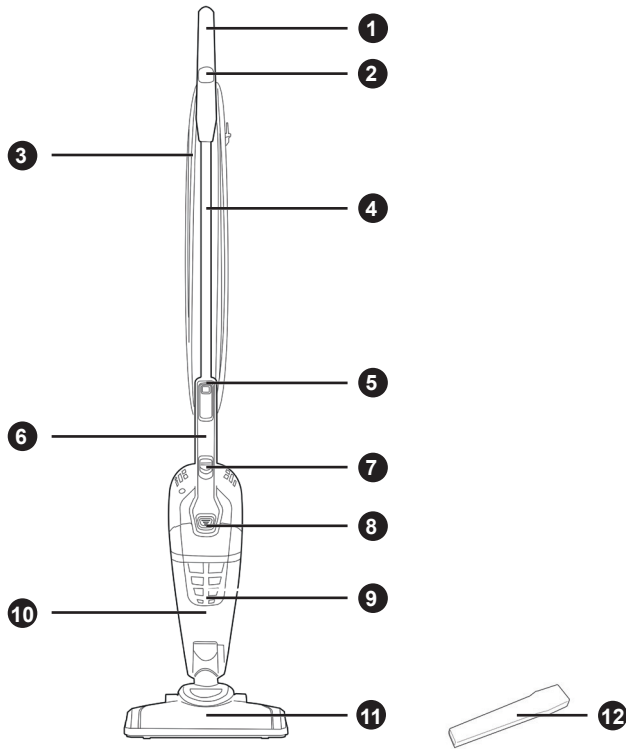

- | | |
|-------------------------|----------------------------|
| 1. Hand Grip | 8. Dust Cup Latch |
| 2. Cord Wrap | 9. Filter |
| 3. Power Cord | 10. Dust Cup |
| 4. Handle | 11. Removable Floor Nozzle |
| 5. Quick Release Button | 12. Crevice Tool |
| 6. Hand Vacuum Grip | |
| 7. Power On/Off | |

⚠ CAUTION: Do not plug in your vacuum cleaner until you are familiar with all instructions and operating procedures.

Assembly/Operation

⚠ WARNING: Do not operate cleaner with damp or wet filters or without vacuum bags and all filters in place.

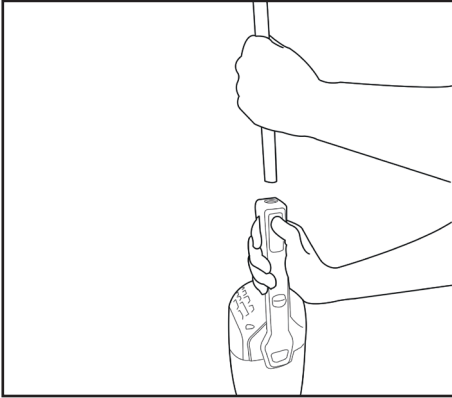

Press the quick release button at the base of the hand vacuum grip and insert the handle, making sure it is all the way inserted into the body of the vacuum.

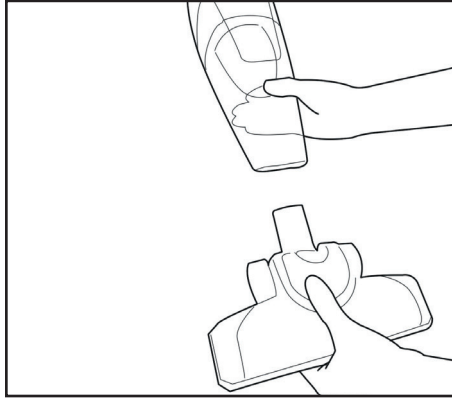

Attach the floor nozzle by inserting it into the opening at the bottom of the dust cup. Press firmly to secure in place.

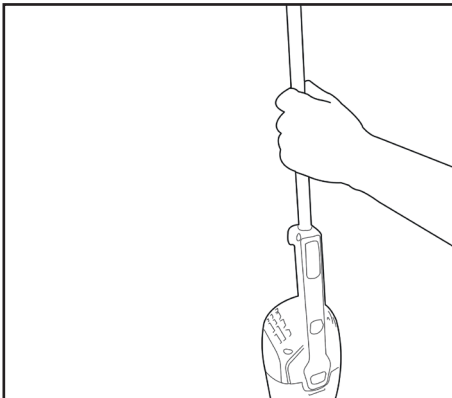

As a Hand Vacuum

Press the button at the base of the hand vacuum grip and pull the handle away from the unit.

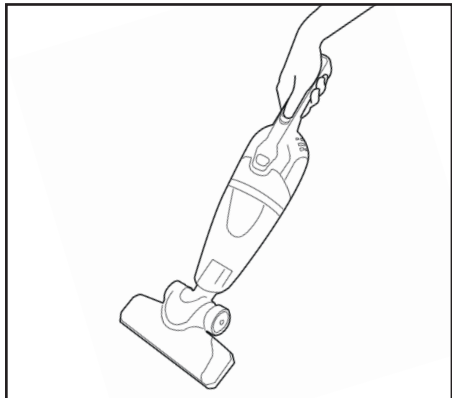

As a Multi-Purpose Vacuum:

The floor nozzle may be used with the hand vacuum to clean wider surfaces. To attach the floor nozzle to the hand vac, insert it into the opening at the bottom of the dust cup. Press firmly to secure in place.

Assembly/Operation

Power cord storage

1. Turn vacuum off (O).
2. Unplug power cord by grasping the polarized plug, NOT the cord, and disconnect from outlet.
3. Loop power cord around cord wrap on the handle.
4. Clip molded plug to power cord to secure.

⚠ WARNING: To avoid injury, turn vacuum OFF and unplug cord from wall when not in use.

Accessories

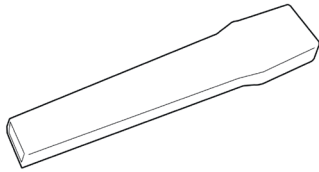

Crevice Tool

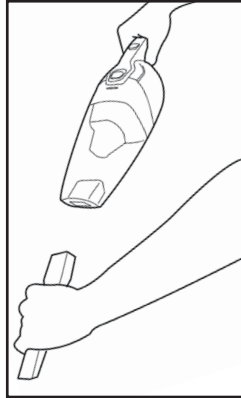

You can insert crevice tool to extend the distance.

Maintenance And Care - Emptying and Cleaning

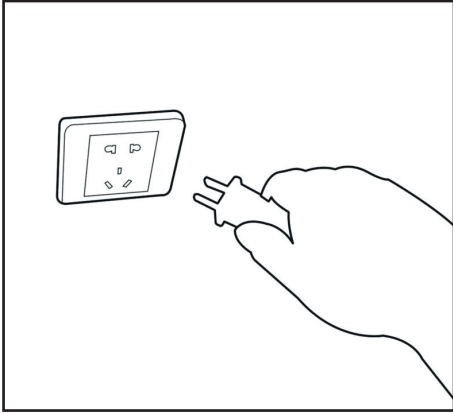

1. Turn Vacuum off (O). Then, unplug vacuum.

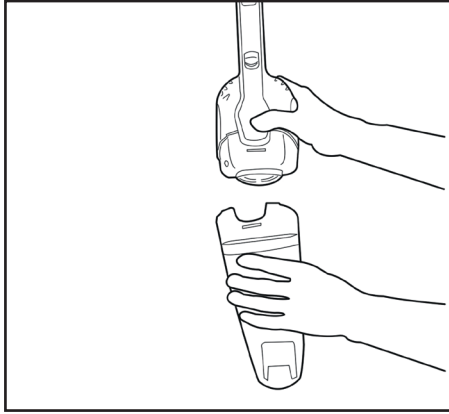

2. To remove dirt from the dust cup and filter, hold the vacuum vertically. Depress and hold button on top of the vacuum to release the dust cup as the shown.

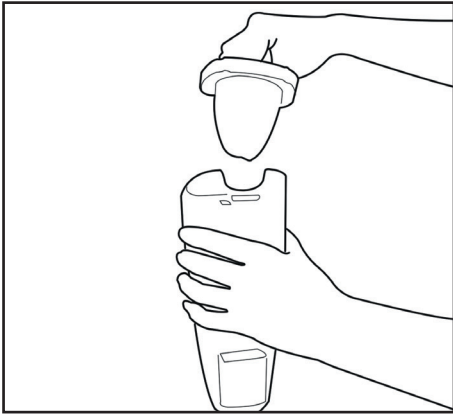

3. Gently pull dust cup away from the hand vacuum grip and remove the filter as shown. Empty into waste container.

4. The dust cup may be rinsed with warm water and a mild detergent if needed. The dust cup must be thoroughly dried before replacing.

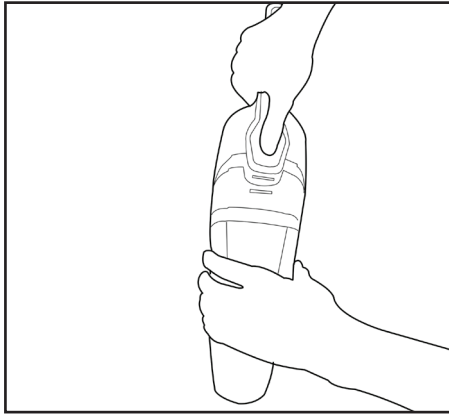

5. Replace filter. Attach dust cup to vacuum by depressing latch and securely fitting onto hand grip. Make sure dust cup is correctly secured.

Maintenance And Care - Cleaning Vacuum And Tools

DO NOT clean the vacuum cleaner, components or accessories using petroleum or any other flammable liquid or solvents, etc.

Clean only the outside of the vacuum cleaner.

Use only a moist cloth and mild detergent for cleaning the vacuum cleaner, components and accessories.

After cleaning, wipe off the moisture on vacuum cleaner, components and accessories with a dry cloth.

DO NOT place accessories, tools or components in a dishwasher.

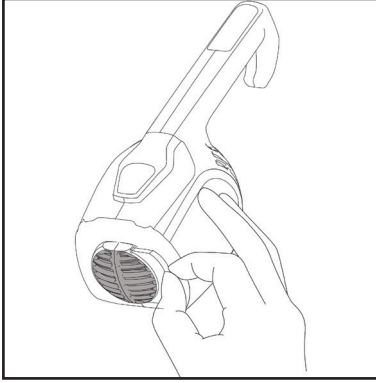

To maintain suction and cleaning performance, you can check pre-motor filters regularly, if needed, pull it out and clean with warm water and a mild detergent. The filter must be thoroughly dried before put back. Replace with black side facing out.

⚠ CAUTION: Never operate your vacuum cleaner without the filter in place. Doing so may damage the motor and void the warranty.

Troubleshooting

⚠ WARNING: To reduce the risk of electric shock, turn power OFF and disconnect plug from electrical outlet before performing maintenance or troubleshooting to the vacuum cleaner.

- | Vacuum cleaner won't run: Possible causes | Remedies |
|--|--|
| 1. Vacuum cleaner is not plugged in firmly | 1. Check electrical outlet |
| 2. Blown fuse/tripped breaker | 2. Check/replace fuse or reset breaker |

Vacuum cleaner won't vacuum effectively: Possible causes	Remedies
1. Filter clogged, wet or dirty.	1. Follow instructions for cleaning.
2. Dust cup clogged.	2. Follow instructions for emptying.
Dust blows out of air vent: Possible causes	Remedies
1. Filter not properly secured to filter frame.	1. Follow instructions for replacing filter above.

Replacement Parts

Item:	Part No.:	Part Name:
1	ST0101	Crevice Tool
2	ST0102	Filter
3	ST0106	Pre-Motor Filter

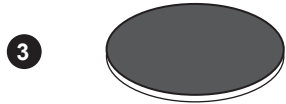
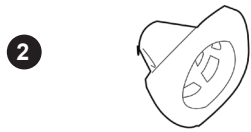
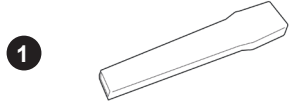

Other maintenance or service not included in the manual should be performed by an authorized service representative. Thank you for selecting a BLACK&DECKER product.

Please do not return this product to the store

For any questions or concerns, please contact our Customer Service at
1-800-524-6716

WARRANTY

ONE-YEAR LIMITED WARRANTY

Midea USA Inc. warrants this product to be free from defects in material or workmanship for a period of one(1) year following the date of purchase, provided that the product is used in a home environment. This limited warranty does not cover failures due to abuse, accidental damage or when repairs have been made or attempted by anyone other than MIDEA authorized service agent. A defective product meeting the warranty conditions set forth herein will be replaced or repaired at no charge in either of two ways:

The first, which will result in exchanges only, is to return the product to the retailer from whom it was purchased (provided that the store is a participating retailer). Returns should be made within the time period of the retailer's policy for exchanges. Proof of purchase may be required. Please check with the retailer for its specific return

policy regarding time limits for returns or exchanges.

The second option is to take or send the product (prepaid) to a MIDEA authorized service agent for repair or replacement at MIDEA's option.

Proof of purchase may be required. This warranty does not apply to accessories. This warranty gives you specific legal rights and you may have other rights which vary from state to state. Should you have any questions, please call customer service at 1-800-524-6716. This product is not intended for commercial use, and accordingly, such commercial use of this product will void this warranty. All other guarantees, express or implied, are hereby disclaimed.

For assistance with your product, call the customer service help line at **1-800-524-6716**

BLACK & DECKER, BLACK+DECKER, the BLACK & DECKER and BLACK+DECKER logos and product names are trademarks of The Black & Decker Corporation, used under license. All rights reserved.

Imported by
Midea USA, Inc.
5 Sylvan Way
Parsippany, NJ 07054, USA

