

This Owner's Manual is provided and hosted by [Appliance Factory Parts](#).



LENNOX HEARTH LMDTV-3328CNM Owner's Manual

[Shop genuine replacement parts for LENNOX HEARTH
LMDTV-3328CNM](#)



[Find Your LENNOX HEARTH Fireplace Parts - Select From 237 Models](#)

----- Manual continues below -----



HEARTH PRODUCTS

RETAIN THESE INSTRUCTIONS
FOR FUTURE REFERENCE

	⚠ WARNINGS
	<ul style="list-style-type: none"> • Hot! Do not touch! The glass and surfaces of this appliance will be hot during operation and will retain heat for a while after shutting off the appliance. Severe burns may result. • Carefully supervise children in the same room as appliance.
<ul style="list-style-type: none"> • If small children are present in the home, it is recommended that this appliance be fitted with a screen door or screen panel kit. See Pages 14 & 15 for ordering information. 	

WARNING: IF THE INFORMATION IN THIS MANUAL IS NOT FOLLOWED EXACTLY, A FIRE OR EXPLOSION MAY RESULT CAUSING PROPERTY DAMAGE, PERSONAL INJURY OR LOSS OF LIFE.

FOR YOUR SAFETY: Do not store or use gasoline or other flammables or liquids in the vicinity of this or any other appliance.

FOR YOUR SAFETY: What to do if you smell gas:

- **DO NOT** light any appliance.
- **DO NOT** touch any electrical switches.
- **Do not** use any phone in your building.
- **Immediately call your gas supplier** from a neighbor's phone. Follow your gas suppliers instructions.
- **If your gas supplier cannot be reached, call the fire department.**

Installation and service must be performed by a qualified installer, service agency or the gas supplier.

Tested & Listed By



Beaverton Oregon USA

OMNI-Test Laboratories, Inc.

OTL Report No. 116-F-31-5

HOMEOWNER'S CARE AND OPERATION INSTRUCTIONS

DIRECT VENT MERIT® LMDV-33/35/40 SERIES

DIRECT-VENT GAS FIREPLACE HEATERS

P/N 875,028M REV. D 05/2006

MODELS

Millivolt Models		Electronic Models
LMDVT-3328CNM	LMDV-3530CNM	LMDVT-3328CNE
LMDVT-3328CPM	LMDV-3530CPM	LMDVR-3328CNE
LMDVR-3328CNM	LMDV-4035CNM	LMDV-3530CNE
LMDVR-3328CPM	LMDV-4035CPM	LMDV-4035CNE

A French manual is available upon request. Order P/N 875,028CF

Ce manuel d'installation est disponible en français, simplement en faire la demande. Numéro de la pièce 875,028CF

AVERTISSEMENT: ASSUREZ-VOUS DE BIEN SUIVRE LES INSTRUCTIONS DONNÉ DANS CETTE NOTICE POUR RÉDUIRE AU MINIMUM LE RISQUE D'INCENDIE OU POUR ÉVITER TOUT DOMMAGE MATÉRIEL, TOUTE BLESSURE OU LA MORT.

POUR VOTRE SÉCURITÉ: Ne pas entreposer ni utiliser d'essence ni d'autre vapeurs ou liquides inflammables dans le voisinage de cet appareil ou de tout autre appareil.

POUR VOTRE SÉCURITÉ: Que faire si vous sentez une odeur de gaz:

- **Ne pas tenter d'allumer d'appareil.**
- **Ne touchez à aucun interrupteur.** Ne pas vous servir des téléphones se trouvant dans le bâtiment où vous vous trouvez.
- **Evacuez la pièce, le bâtiment ou la zone.**
- **Appelez immédiatement votre fournisseur de gaz** depuis un voisin. Suivez les instructions du fournisseur.
- **Si vous ne pouvez rejoindre le fournisseur de gaz, appelez le service des incendies.**

L'installation et service doit être exécuté par un qualifié installateur, agence de service ou le fournisseur de gaz.

SAFETY & WARNING INFORMATION

IMPORTANT: PLEASE READ THIS MANUAL IN ITS ENTIRETY AND UNDERSTAND THESE RULES TO FOLLOW FOR SAFETY.

	! WARNING If the information in this manual is not followed exactly, a fire or explosion may result causing property damage, personal injury or loss of life.
	

! WARNING
Improper installation, adjustment, alteration, service or maintenance can cause injury or property damage. Refer to this manual. For assistance or additional information consult a qualified installer, service agency or the gas supplier.

! WARNING
Failure to comply with the installation and operating instructions provided in this document will result in an improperly installed and operating appliance, voiding its warranty. Any change to this appliance and/or its operating controls is dangerous. Improper installation or use of this appliance can cause serious injury or death from fire, burns, explosion or carbon monoxide poisoning.

! IMPORTANT
These appliances must not be connected to a chimney or flue serving a separate Solid-Fuel burning appliance.

! WARNING
Children and adults should be alerted to the hazards of high surface temperatures. Use caution around the appliance to avoid burns or clothing ignition. Young children should be carefully supervised when they are in the same room as the appliance.

Note: An Optional Screen Panel for the glass is available (see Pages 14 & 15 for ordering information).

! WARNING
Do not place clothing or other flammable materials on or near this appliance.

! AVERTISSEMENT
Surveiller les enfants. Garder les vêtements, les meubles, l'essence ou autres liquides à vapeur inflammables à cote de l'appareil.

! WARNING
Carbon monoxide poisoning: early signs of carbon monoxide poisoning are similar to the flu with headaches, dizziness and/or nausea. If you have these signs, obtain fresh air immediately. Turn off the gas supply to the appliance and have it serviced by a qualified professional, as it may not be operating correctly.

! WARNING
Any safety guard or screen removed for servicing the appliance must be replaced prior to operating the appliance.

NOTE: DIAGRAMS & ILLUSTRATIONS NOT TO SCALE.

! WARNING
Do not use these appliances if any part has been under water. Immediately call a qualified, professional service technician to inspect the appliances and to replace any parts of the control system and any gas controls which have been under water.

! AVERTISSEMENT
Ne pas se servir de cet appareil s'il a été plongé dans l'eau, complètement ou en partie. Appeler un technicien qualifié pour inspecter l'appareil et remplacer toute partie du système de contrôle et toute commande qui ont été plongés dans l'eau.

! WARNING
Do not attempt to alter or modify the construction of the appliance or its components. Any modification or alteration may void the warranty, certification and listings of this unit.

! WARNING
This appliance is only for use with the type of gas indicated on rating plate. This appliance is not convertible for use with other gases, unless a certified kit is used.

! AVERTISSEMENT
Cet appareil doit être utilisé uniquement avec les types de gaz indiqués sur la plaque signalétique. Ne pas l'utiliser avec d'autres gaz sauf si un kit de conversion certifié est installé.

! WARNING
These fireplaces are vented heaters. Do not burn wood or other material in these appliances.

CONGRATULATIONS!

In selecting this LENNOX Direct-Vent Gas Appliance you have chosen the finest and most dependable fireplace to be found anywhere. Its a beautiful, prestigious alternative to a wood burning fireplace. Welcome to a Family of tens of thousands of satisfied LENNOX Fireplace Owners.

Please carefully read and follow all of the instructions found in this manual. Please pay special attention to the safety instructions provided in this manual. The Homeowner's Care and Operation Instructions included here will assure that you have many years of dependable and enjoyable service from your LENNOX product.

TABLE OF CONTENTS

Safety & Warning Information	Page 2
Introduction	Page 3
General Information	Page 3
Gas Controls Access	Page 4
Operation/Care of Your Appliance	Page 4
Variable Flame Adjustment.....	Page 5
Maintenance.....	Page 6
Front Glass Enclosure Panel, Removal and Installation.....	Page 6
Install Vermiculite, Volcanic Stone, Embers & Logs	Page 8
Burner Flame Appearance & Sooting	Page 11
Burner Flame Adjustments	Page 12
Millivolt Appliance Checkout	Page 12
Electronic Appliance Checkout.....	Page 12
Wiring Diagrams	Page 13
Warranty	Page 13
Product Reference Information.....	Page 13
Accessory Components	Page 14
Lighting Instructions – Millivolt	Page 18
Lighting Instructions – Electronic	Page 20
Maintenance Schedule	Page 22
Troubleshooting Guide – Millivolt	Page 23
Troubleshooting Guide – Electronic	Page 23
Replacement Parts List	Page 25

INTRODUCTION

The Fireplace models covered in this manual are Direct-Vent sealed combustion gas fireplace heaters designed for residential application. Direct-Vent appliances operate with the combustion chamber completely isolated from the indoor environment. All air for combustion is brought in from the outside and exhaust gases are vented through the same direct vent, co-axial (intake/exhaust) vent system.

The Millivolt appliances have a millivolt gas control valve with piezo ignition system provides safe, efficient operation. If any optional accessories which require electrical power are being installed, the electrical power must be provided at the time of appliance installation.

The Electronic appliances have an electronic intermittent pilot system provides safe, efficient operation. External electrical power is required to operate these appliances.

These appliances comply with National Safety Standards and are tested and listed by Omni-Test Laboratories (Report No. 116-F-31-5) to ANSI Z221.88b-2003 (in Canada, CSA-2.33b-2003), and CAN/CGA-2.17-M91 in both USA and Canada, as vented gas fireplace heaters.

The Installation must conform to local codes or, in the absence of local codes, with the National Fuel Gas Code, ANSI Z223.1/NFPA 54-latest edition, or the Natural Gas and Propane Installation Code, CSA B149.1-latest edition. The appliance, when installed, must be electrically grounded in accordance with local codes or, in the absence of local codes, the latest edition of the National Electrical Code, ANSI/NFPA 70, or the Canadian Electrical Code, CSA C22.1 - latest editions.

GENERAL INFORMATION

Note: Installation and repair should be performed by a qualified service person. The appliance should be inspected annually by a qualified professional service technician. More frequent inspections and cleanings may be required due to excessive lint from carpeting, bedding material, etc.

It is imperative that the control compartment, burners and circulating air passage ways of appliance be kept clean. See Maintenance instructions on **Page 6**.

S'assurer que le brûleur et le compartiment des commandes sont propres. Voir les instructions d'installation et d'utilisation qui accompagnent l'appareil.

Provide adequate clearances around air openings and adequate accessibility clearance for service and proper operation. Never obstruct the front openings of the appliance.

Due to high temperatures the appliance should be located out of traffic and away from furniture and draperies. Locate furniture and window coverings accordingly.

These fireplaces are designed as supplemental heaters. Therefore, it is advisable to have an alternate heat source when installed in a dwelling.

These appliances are designed to operate on natural gas or propane gas only. The use of other fuels or combination of fuels will degrade the performance of this system and may be dangerous.

Millivolt Models - BTU Input

Millivolt models come standard with the mAnnually-modulated gas valve; flame appearance and heat output can be controlled at the gas valve. The BTU Input for millivolt models is shown in **Tables 1 & 2**:

Input (BTU) MAnnually-Modulated Gas Valves (millivolt models)	
NATURAL GAS	
Models	Input Rate (BTU/HR)
LMDVT-3328CNM LMDVR-3328CNM	17,500 high 11,700 low
LMDV-3530CNM	20,000 high 12,800 low
LMDV-4035CNM	27,000 high 18,500 low

Table 1

Input (BTU) MAnnually-Modulated Gas Valves (millivolt models)	
PROPANE GAS	
Models	Input Rate (BTU/HR)
LMDVT-3328CPM LMDVR-3328CPM	17,500 high 14,000 low
LMDV-3530CPM	20,000 high 15,200 low
LMDV-4035CPM	27,000 high 21,500 low

Table 2

Electronic Models -

Electronic models have a fixed rate gas valve. The BTU Input for electronic models is shown in **Table 3**:

Input (BTU) - Fixed Rate (electronic models)	
NATURAL GAS & PROPANE GAS	
Models	Input Rate (BTU/HR)
LMDVT-3328CNE LMDVR-3328CNE	17,500
LMDV-3530CNE	20,000
LMDV-4035CNM LMDV-4035CPM	28,000

Table 3

Gas Pressure -

Tables 4, 5 and 6 show the appliances' gas pressure requirements.

Inlet Gas Supply Pressure (all models)		
Fuel #	Minimum	Maximum
Natural Gas	5.0" WC (1.24 kPa)	10.5" WC (2.61 kPa)
Propane	11.0" WC (2.74 kPa)	13.0" WC (3.23 kPa)

Table 4

Manifold Gas Supply Pressure (millivolt models)		
Fuel #	Low	High
Natural Gas	(Lo) 2.2" WC (.55 kPa)	(Hi) 3.5" WC (.87 kPa)
Propane	(Lo) 6.3" WC (1.57 kPa)	(Hi) 10.0" WC (2.49 kPa)

Table 5

Manifold Gas Supply Pressure (electronic models)	
Fuel #	Fixed
Natural Gas	3.5" WC (.87 kPa)
Propane	10.0" WC (2.49 kPa)

Table 6

Test gauge connections are provided on the front of the millivolt gas control valve, identified IN for the inlet and OUT for the manifold side (see **Figures 4 or 5** on **Page 5**). A 1/8" NPT Test gauge connection is provided at the inlet and outlet (manifold) ports on the electronic gas control valve (see **Figure 3** on **Page 5**).

These appliances must be isolated from the gas supply piping system (*by closing their individual manual shut-off valve*) during any pressure testing of the gas supply piping system at test pressures equal to or **less than** 1/2 psig (3.5 kPa).

These appliances and their individual shut-off valves *must be disconnected* from the gas supply piping system during any pressure testing of that system at pressures **greater than** 1/2 psig (3.5 kPa).

Orifice Sizes - Sea Level to High Altitude

(All Models): These appliances are tested and approved for installations at elevations of 0-4500 feet (0-1372 meters) above sea level using the standard burner orifice sizes (marked with an "*" in **Table 7**).

At the time of installation, it must be determined if the appliance needs to be derated. Contact your local gas supplier for deration requirements for your area.

Deration - At higher elevations, the amount of BTU fuel value delivered must be reduced by either using gas that has been derated by the gas company or by changing the burner orifice to a smaller size as regulated by the local authorities having jurisdiction and by the (USA) National Fuel Gas Code NFPA 54/ANSI Z223.1 - latest edition or, in Canada, the CAN1-B149.1 and .2 codes - latest edition.

Burner Orifice Sizes Elevation 0-4500 feet (0-1372 meters)		
Model Series	Natural Gas drill size (inches)	Propane Gas drill size (inches)
LMDVT-3328 LMDVR-3328	#45 (.082") * 39L66 •	1.2 mm (.048") * 99K78 •
LMDV-3530	#44 (.086") * 60J80 •	#55 (.052") * 19L52 •
LMDV-4035	#37 (.104") * 24M10 •	1/16" (.0625") * 21L01 •

* Standard size installed at factory
• Part/Cat. Number

Table 7

Burn-in Period

During the first few fires of this appliance there will be some odor due to the curing of the paint and burning off of lubricants used in the manufacturing process.

Depending on your use, the burn-in period may take a few hours or a few days.

KEEP YOUR HOUSE WELL VENTILATED DURING THE CURING PROCESS. THE ODOR AND HAZE EMITTED DURING THE CURING PROCESS CAN BE QUITE NOTICEABLE AND MAY SET OFF A SMOKE DETECTOR.

If an optional blower is installed, Do not turn it on during the Burn-In period.

A white film may develop on the glass front during the first few fires as part of the curing process. The glass should be kept clean during the first two weeks of use to prevent the film from baking on (making it very difficult to remove). See **Cleaning Glass** on **Page 6**.

Gas Controls/Control Compartment Access

The gas controls can be found behind the control compartment access door.

Removing Control Compartment Door:

Open the door by gently lifting it upward until the hook catches on both sides clear the locating slots. Then pull door out to remove.

On millivolt systems, the piezo igniter, HI/LO flame adjustment knob, and pilot and main gas OFF/ON control knob are located below the glass panel enclosure. The gas valve for electronic systems is also located below the glass enclosure panel. See **Figure 1**.

Reinstalling Control Compartment Door:

To reinstall, insert the hook catches on each side of the door into the corresponding slots in the control compartment opening, then gently push forward and slide down until it locks in place.

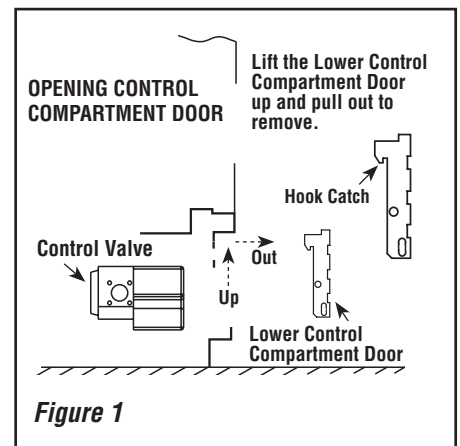

Figure 1

OPERATION AND CARE OF YOUR APPLIANCE

The standard controls for appliance operation are located behind the panel below the appliance front glass enclosure panel (see **Figure 1**). Optional control switches are also available (see **Page 14 - Remote Wall Switch, Remote Control or Wall Thermostat**).

Operation of millivolt and electronic gas control systems are different. Before lighting and operating your appliance determine if you have a millivolt or electronic appliance. Familiarize yourself with the gas control valve that your appliance uses. Refer to **Figure 1** for access to the gas control valve.

NOTE: DIAGRAMS & ILLUSTRATIONS NOT TO SCALE.

Millivolt Appliances - Appliances with Millivolt systems will be fitted with the gas control valve shown in **Figures 4 or 5**.

Electronic Appliances - Appliances with electronic systems will be fitted with the electronic valve shown in **Figure 3**.

Millivolt Appliances - To light millivolt appliances refer to the detailed lighting instructions found on **Pages 18 & 19**. Millivolt appliance lighting instructions may also be found on the pull out lighting instruction labels attached to the gas control valve.

Millivolt appliances are fitted with an OFF/ON Rocker Switch located behind the control compartment access door, below the appliance front glass enclosure panel (see **Figure 2** for location). Once the pilot is lit, the OFF/ON rocker switch will control the appliance OFF/ON burner operation. To operate: Toggle the switch between its ON and OFF positions.

If your millivolt appliance is equipped with an optional remote switch kit (wall switch, remote control or wall thermostat) and the pilot is lit, the appliance main burner may be turned on and off using the optional switch. When using an optional remote switch, turn off the standard OFF/ON switch.

Note: To prevent excessive resistance in burner circuit (which can cause burner operation problems), only one burner control switch should be wired to valve. Therefore, if an optional control switch is installed, the standard Off/On switch and wires should be removed.

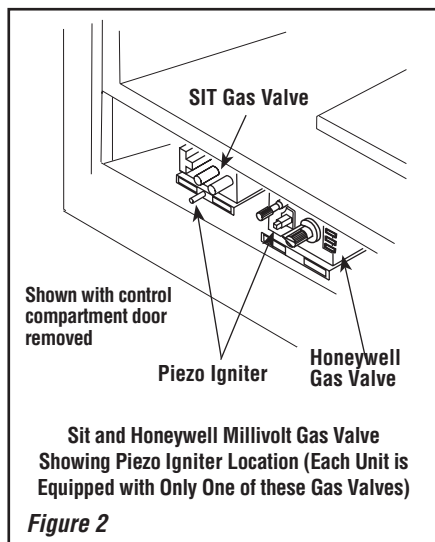

Electronic Appliances -

To light electronic appliances refer to the detailed lighting instructions found on **Pages 20 & 21** of these instructions. Electronic appliance lighting instructions may also be found on the pull out lighting instruction labels attached to the gas control valve.

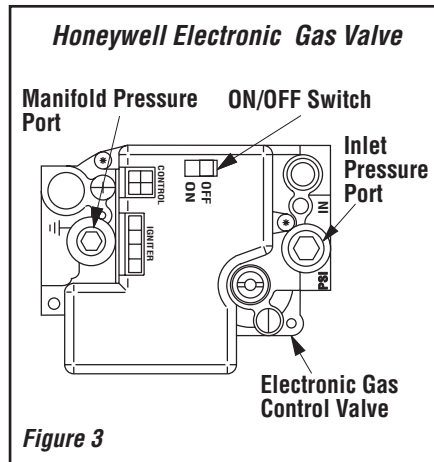

If your electronic appliance is equipped with an optional remote wall switch or remote control kit the appliance main burner may be turned on and off with the wall switch or remote control.

If your electronic appliance is not equipped with a wall switch or remote control, the main burner must be turned off and on with the gas control switch. Toggle the switch from ON to OFF to operate the main burner .

Variable Flame Height Adjustment (Millivolt Appliances only)

1. All Millivolt appliances are equipped with a variable gas control valve. Flame height for these models may be adjusted through a range between fixed low and high settings while the appliance is in operation. Adjust the flame height as desired after lighting the appliance by rotating the variable adjustment control knob (HI/LO) located on the front of the valve (refer to **Figures 4 & 5**).
2. During the first initial burns of these appliances, there will be some odor emitted (see **Burn-In Period** on **Page 4**).

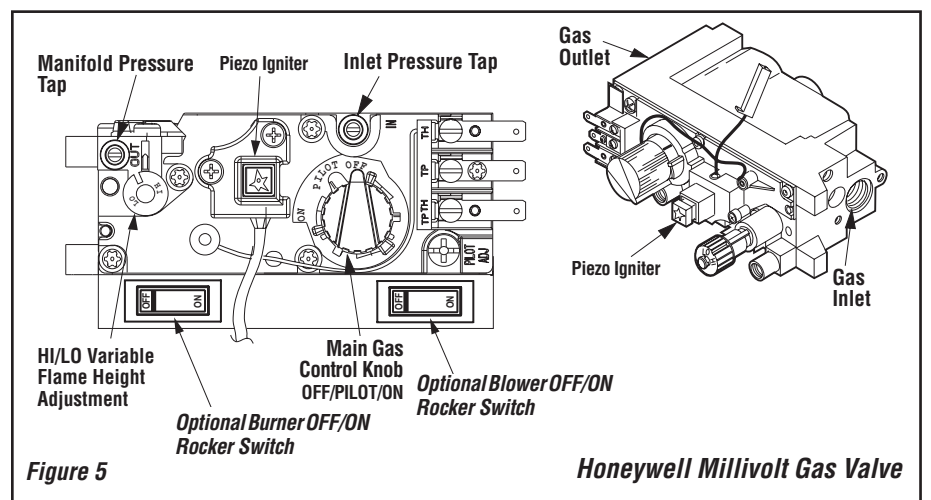
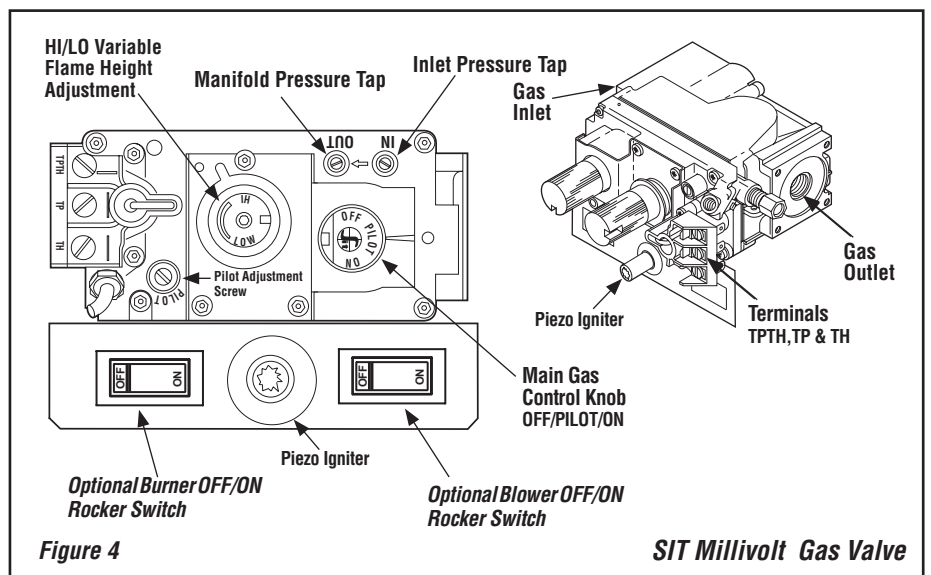

NOTE: DIAGRAMS & ILLUSTRATIONS NOT TO SCALE.

3. Keep the lower control compartment clean by vacuuming or brushing at least twice a year. More frequent cleaning may be required due to excessive lint from carpeting, bedding materials, pet hair, etc. **It is very important that the control compartments, burners and circulating air passageways of the appliance are kept clean.**
4. Always turn off gas to the pilot (millivolt appliances) and let the appliance cool down before cleaning. Before re-lighting, refer to the lighting instructions in this manual. Lighting instructions may also be found on the pull out lighting instruction labels attached to the gas control valve.
5. Always keep the appliance area clear and free from combustible materials, gasoline and other flammable liquids.
6. Remember, Millivolt appliances have a continuous burning pilot flame. Exercise caution when using products with combustible vapors.

MAINTENANCE

(See Maintenance Schedule, Page 22)

Refer to the maintenance schedule for maintenance tasks, procedures, periodicity and by whom they should be performed. Always verify proper operation of the appliance after servicing.

WARNING

Turn off gas and electrical power before servicing the appliance.

CAUTION

Wear gloves and safety Glasses for protection while doing required maintenance.

IMPORTANT

Always verify proper operation after servicing.

Before re-lighting the fireplace, refer to the lighting instructions in this manual. Instructions are also found on pull-out panels located below the glass door in the control compartment.

Inspect Venting System

The appliance and venting system should be thoroughly inspected before initial use and at least annually by a qualified service technician (inspection should include ensuring that exhaust or intake passages are unobstructed and vent components are properly assembled and not damaged).

If the venting system is disassembled for any reason, a qualified service technician should follow vent installation instructions for proper reassembly and proper sealing of the venting system components. However, more frequent periodic inspections and cleanings should be performed by the homeowner.

Clean Lower Control Compartment

Keep lower control compartment clean by vacuuming or brushing it out at least twice a year (also clean the air venturi with a brush or wire). More frequent cleaning may be required due to accumulation of lint from carpeting, bedding materials, pet hair, spider webs, etc. **It is very important that control compartments, burners, circulating air passageways and air venturi on the appliance are NOT obstructed in any way.**

Cleaning Glass

(see *Front Glass Enclosure Panel, Removal and Installation* on **Page 7**)

Note: Clean glass after first two weeks of operation (after Burn-In period is over) and then only when necessary and when the fireplace is cool. Wipe surface with clean, dampened, soft cloth. Follow with dry, soft towel as desired. Take care not to scratch the glass surface.

The viewing glass should be cleaned periodically to remove any build-up caused from the following:

IMPORTANT

Do not use abrasive cleaners on glass. Never clean the glass when it is hot.

- During start-up, it is normal for condensation to form on the inside of the glass (this condensation and fog will usually disappear in a few minutes). The moisture can cause lint, dust and other airborne particles to cling to the glass surface.
- Initial curing of the high temperature paint and burning off of lubricants used in the manufacturing process may result in a film on the glass.
- A white coating may form on the glass as a result of impurities and minerals in the fuel.

It is recommended that the glass be cleaned two or three times during each heating season, depending on the circumstances present. The following cleaning solutions are approved for use to clean glass:

- Non-ammonia based household cleaner
- 50%-50% mix of white vinegar & water
- Gas fireplace/stove glass cleaner

Inspect Glass Gasket - Visually inspect the gasket on the backside of the glass enclosure panels. The gasket surface must be clean, free of irregularities and seated firmly.

Clean Logs And Burner

Carefully remove the logs (use care when handling the fiber logs, as they become quite fragile after curing). Vacuum out any foreign matter (lint, carbon, etc) on the burner. Ensure the burner ports are "open." Remove any carbon deposits from the under side of the logs using a vacuum cleaner, or a soft bristled brush (i.e. paint brush). Note: Improper positioning of logs can create carbon build-up and will alter the performance of the appliance. **Replacing Logs** -

If the logs become damaged by accident or improper handling and need replacement, use only the proper replacement logs from manufacturer (see **Pages 25 & 26** for ordering information).

Re-Install Embers, Logs and Vermiculite

- Carefully follow placement instructions on **Pages 8 to 10**. All logs should fit onto corresponding pins and/or log stoppers. This will ensure a proper flame and safe combustion.

Inspect Wiring

Refer to wiring diagrams on **Page 13**.

WARNING

Label all wires prior to disconnection when servicing controls. Wiring errors can cause improper and dangerous operation. Verify proper operation after servicing.

Inspect and clean all wire connections. Ensure that there is no melting or damage. Inspection should include:

- Terminals at the Valve
- OFF/ON Switch
- (Optional Control Switch) Wall Thermostat, Remote Control or Remote Wall Switch Kit

Inspect Burner Flame Appearance

Ensure that the burner flame appearance resembles the flame shown in **Figures 10 & 11** and as described in *Flame Appearance and Sooting* on **Page 11**. The Homeowner must contact a qualified service technician at once if any abnormal condition is observed.

Small Area Paint Touch-up

The finish of the appliance is a high-quality powdercoat. Only use factory supplied powdercoat paint kit for touch-ups. Paint is available at your local authorized Lennox Hearth Products dealer, cat. no. 90L74. Never attempt to paint a hot fireplace.

Do not attempt to repaint the appliance until the finish is completely cured (see *Burn-In Period* on **Page 4**). If the surface later becomes stained or marred, it may be lightly sanded and touched up with spray paint.

NOTE: DIAGRAMS & ILLUSTRATIONS NOT TO SCALE.

Front Glass Enclosure Panel, Removal and Installation

! WARNING

Do not operate appliance with the glass front removed, cracked or broken. Replacement of the glass should be done by a licensed or qualified service technician.

! WARNING

Do not attempt to substitute the materials used on this door, or replace cracked or broken glass with any materials other than those provided by the appliance manufacturer.

! WARNING

Handle this glass with extreme care! Tempered glass is susceptible to damage – do not scratch or handle roughly while reinstalling the glass door frame.

! WARNING

Do not attempt to touch the front enclosure glass with your hands while the fireplace is in use.

! WARNING

The glass door of this appliance must only be replaced as a complete unit as provided by the manufacturer. Do not attempt to replace broken, cracked or chipped glass separately.

These are direct-vent appliances. They are designed to operate only when the front glass enclosure panel is installed. Generally the front glass enclosure panel should not be removed except to gain access to the components within the firebox, and the appliance may only be operated without the front glass enclosure panel in place for very brief periods of time during appliance checkout and adjustment. Note: The flame appearance will be diminished while the front glass enclosure panel is removed.

During this appliance checkout and adjustment period, a potential safety hazard exists - **EXERCISE EXTREME CAUTION** to prevent the occurrence of any burn injuries from the exposed flames or hot surfaces. Also note, that while the front glass enclosure panel (or any of the panels) is removed, the flame appearance will appear to be smaller than normal.

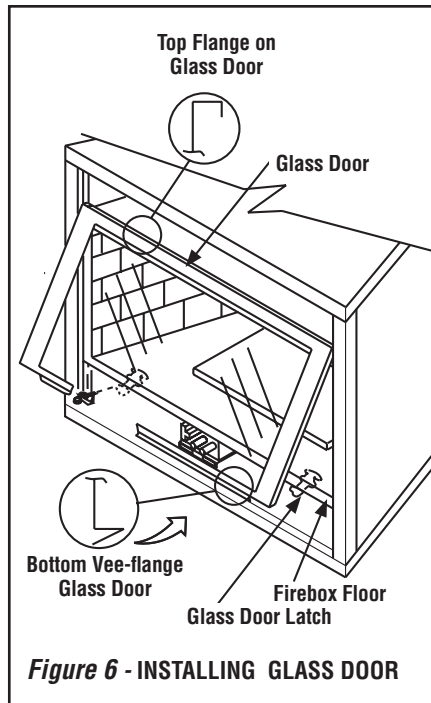

NOTE: DIAGRAMS & ILLUSTRATIONS NOT TO SCALE.

Removing Glass Enclosure Panels (see Figure 6)

1. Remove the top louver assembly by pulling it up and out.
2. Remove the control compartment access door (see removal instructions on **Page 4 - Removing Control Compartment Door**).
3. Locate the two (2) latches at the top of the control compartment. To disengage the two latches from the bottom vee-flange of the glass enclosure panel, reach for the handles located towards the back of the latches and pull the handles down toward the front of the appliance.
4. Swing the bottom of the door out and raise it slightly to lift the top flange of the door frame away from the appliance.

Installing Glass Enclosure Panels (see Figure 6)

1. Visually inspect the gasket on the backside of the glass panel. The gasket surface must be clean, free of irregularities and seated firmly.
2. Position the glass enclosure panel in front of the firebox opening at a 45 degree angle and engage the top flange over the lip at the top of the firebox opening. **See Figure 6.**
3. Swing the glass enclosure panel down and back. Ensure the gasket seats evenly as the panel draws shut. Engage the Vee-flange at the bottom of the panel with the latches and close the latches to secure the panel.
4. Reinstall the control compartment door see installation instructions on **Page 4 , Reinstalling Control Compartment Door**.

INSTALL VERMICULITE, VOLCANIC STONE, GLOWING EMBERS AND LOGS

1. **Remove the front glass enclosure panel** (see *Removing Glass Enclosure Panels* on this page).
2. **Carefully remove the old logs, embers volcanic stone and vermiculite from the firebox.** Handle logs carefully to prevent breakage.
3. **Install Vermiculite** - Place some vermiculite on the firebox floor around the burner (the entire bag of vermiculite will NOT be used). See *Figures 8 & 9*. **DO NOT PLACE ANY VERMICULITE ON THE BURNER.** Mound up a portion of the vermiculite in front of the burner.
4. **Install decorative volcanic stone** - Sprinkle the decorative volcanic stone (dark colored) on top of the vermiculite (light colored) in a pleasing pattern (see *Figures 8 & 9*).
5. **Placement of Glowing Embers** - Separate the Embers (rockwool) into pieces about the size of a quarter (see *Figure 7*). Keep the pieces fluffed up, not matted. Distribute these pieces over the surface of the burner, as shown in *Figures 8 & 9*. Do not use more than is necessary. Ensure that the main burner slots remain uncovered by the ember material.
Note: This appliance is provided with enough Glowing Embers for several applications, do not use all that is in a new bag at one time. For best glowing effect, replace the ember material annually.
6. **Placement of Logs and Twigs** - All logs that have locating notches or slots to help ensure that they are properly positioned. All top logs that rest on lower logs, do so over notches, indents or pins. Proper twig placement is critical to prevent sooting. Twigs should be placed in the gaps between the flame peaks and should be positioned so they do not impinge the flames.

LMDV-3328 & LMDV-3530 - Install as Follows

Carefully position the ceramic fiber logs and twigs over the burner as shown in *Figure 8*. Logs should be placed in the order shown and per the following instructions.

1. Place the rear log (A) as shown. Position the 2 notches on the bottom of the log over the 2 corresponding locating brackets against the back wall of firebox.
2. Place the left log (B) as shown. The notch on the bottom of the log should fit over the corresponding locating bracket.
3. Place the right log (E) as shown. The hole on the back of the log should fit over the corresponding pin on the rear log (A). Make sure that the log is positioned so it aligns to the sides of the gas ports on the corner of the burner.
4. Place the left center log (C) as shown. The forked end of the log fits into the corresponding notch on rear log (A). The slot on the other end (bottom) of log fits over the corresponding locating bracket on the sub-floor.
5. Place the right center log (D) as shown. One end of the log fits into the corresponding indent on the right log (E). The slot on the other end (bottom) of log fits over the corresponding locating bracket on the sub-floor.

LMDV-4035 - Install as Follows

Carefully position the ceramic fiber logs and twigs over the burner as shown in *Figure 9*. Logs should be placed in the order shown and per the following instructions.

1. Position the center log (C) onto the 2 corresponding location pins on the burner.
2. Place the rear log (A) as shown. Position the 2 notches on the bottom of the log over the 2 corresponding locating brackets against the back wall of firebox.
3. Place the left log (B) as shown. The notch on the bottom of the log should fit over the corresponding locating bracket.
4. Place the right log (E) as shown. The notch on the bottom of the log should fit over the corresponding locating bracket. Make sure that the log is positioned so it aligns to the sides of the gas ports on the corner of the burner.
5. Place the center front log (D) as shown. The slot in the bottom of the log fits over the corresponding location bracket on the sub-floor.

! WARNING

DO NOT attempt to install the logs until the appliance installation has been completed, the gas line connected and tested for leaks and the initial burner operation has been checked out.

NOTE: DIAGRAMS & ILLUSTRATIONS NOT TO SCALE.

! WARNING

The size and position of the log set was engineered to give the appliance a safe, reliable and attractive flame pattern. Any attempt to use a different log set in the fireplace will void the warranty and will result in incomplete combustion, sooting, and poor flame quality.

! WARNING

This appliance is not designed to burn wood. Any attempt to do so could cause irreparable damage to appliance and prove hazardous to your safety.

! WARNING

If logs are not installed according to the log installation instructions, flame impingement and improper combustion could occur and result in soot and/or excessive production of carbon monoxide (CO), a colorless, odorless, toxic gas.

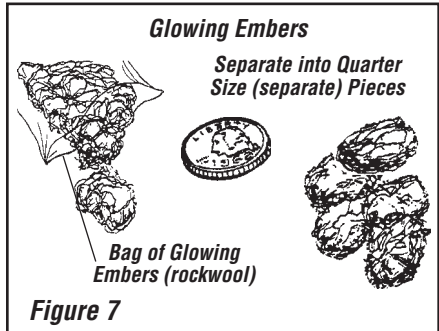

REFERENCE Firebox Accessories/Parts

Cat. No.	Model No.	Description
88L53	FGE	Bag of Glowing Embers (1 oz. rockwool)
H3696		Vermiculite, Bag (2 liters)
80L42	FDVS	Bag of Decorative Volcanic Stone

Table 8

MODEL LMDV-3328 & LMDV-3530 Log Placement Instructions

LOG SET Catalog Number H3366	
* Item	Description
A	Log, Rear
B	Log, Left
C	Log, Left Center
D	Log, Right Center
E	Log, Right
* Item "letters" above correspond to photos	

Install the Embers, Vermiculite, Volcanic Stone and Logs in the order shown here (1 through 6) and per the instructions on Page 8.

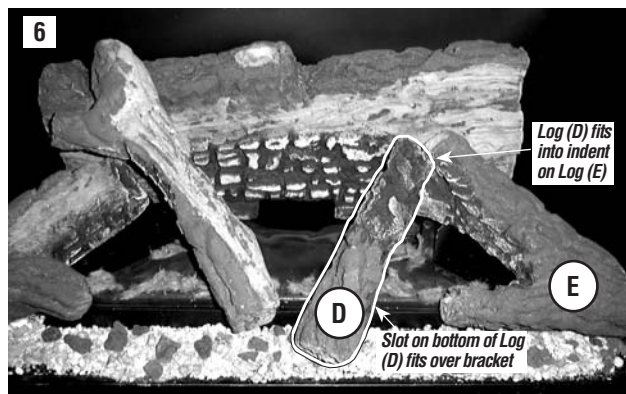
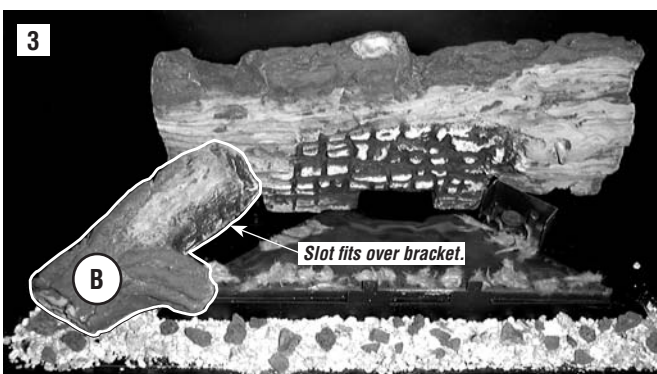
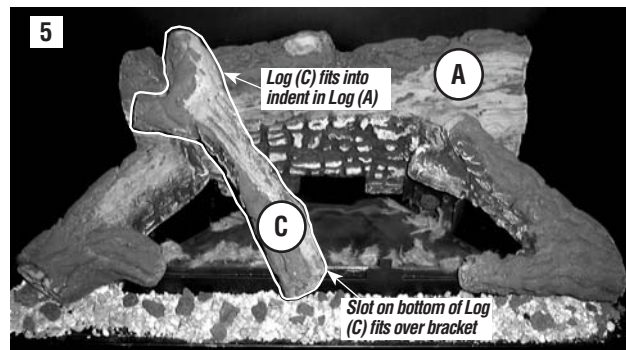
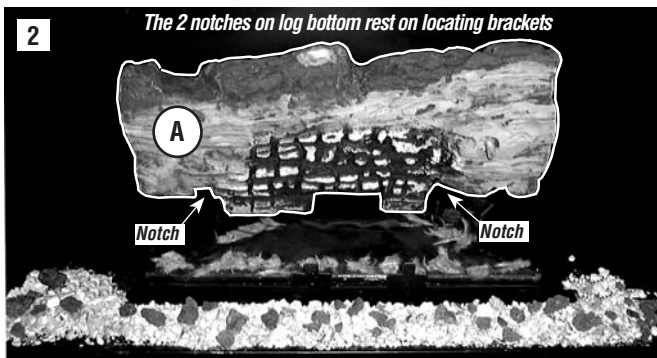
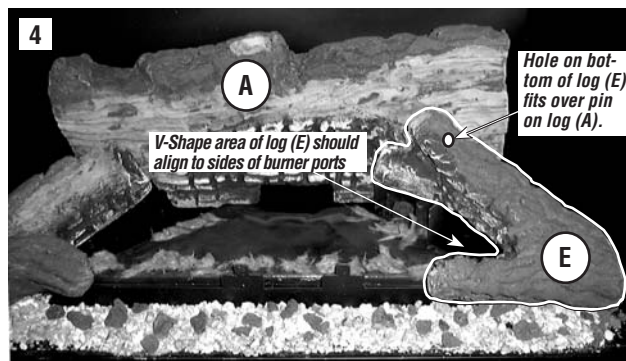
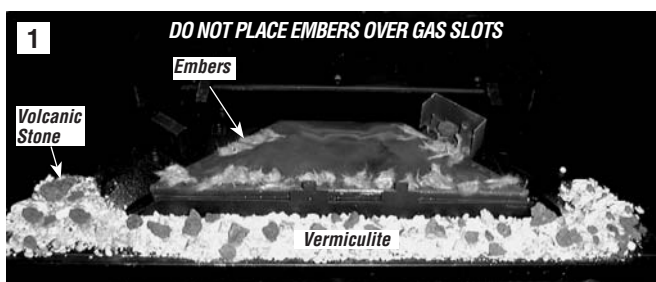
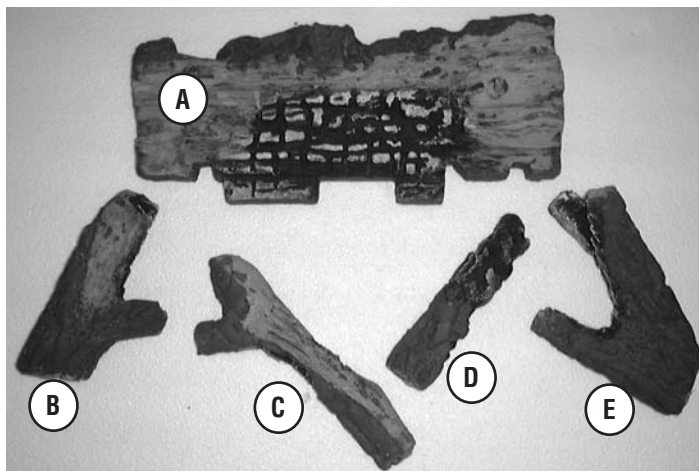

Figure 8

NOTE: DIAGRAMS & ILLUSTRATIONS NOT TO SCALE.

MODEL LMDV-4035

Log Placement Instructions

LOG SET Catalog Number H3365	
* Item	Description
A	Log, Rear
B	Log, Left
C	Log, Center
D	Log, Center Front
E	Log, Right

* Item "letters" above correspond to photos

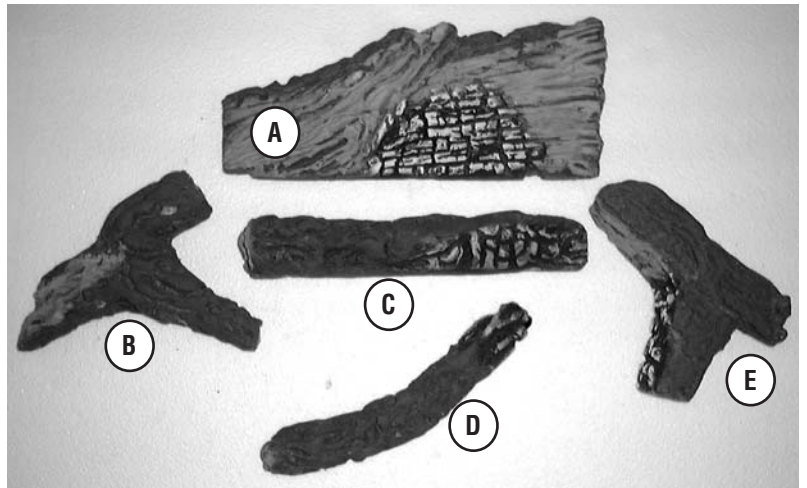

Install the Embers, Vermiculite, Volcanic Stone and Logs in the order shown here (1 through 6) and per the instructions on Page 8.

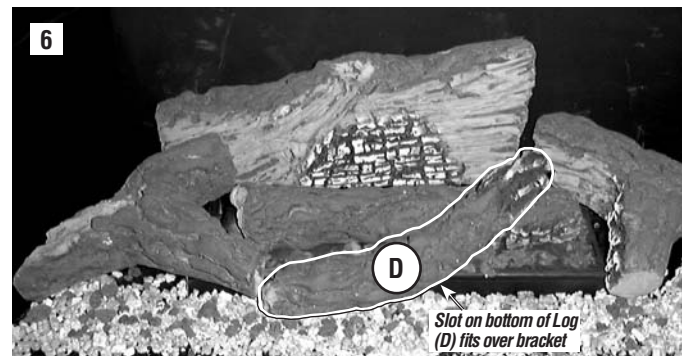
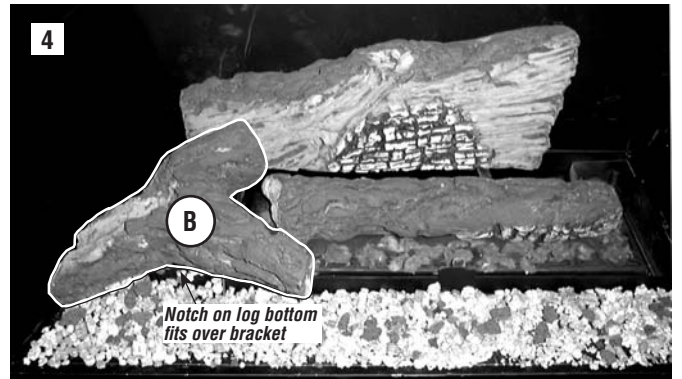
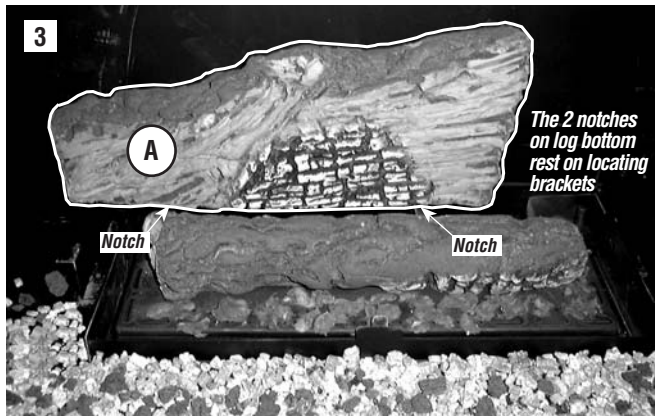
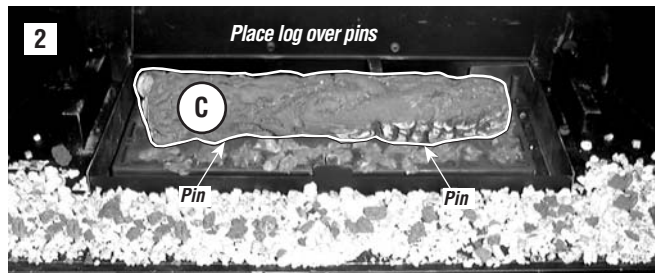
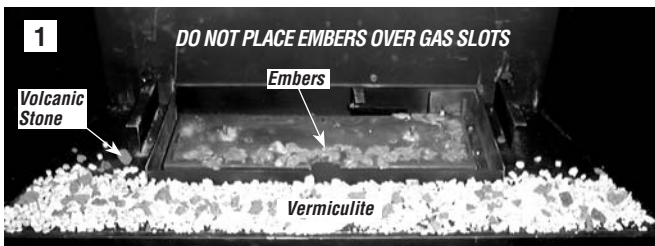

Figure 9

NOTE: DIAGRAMS & ILLUSTRATIONS NOT TO SCALE.

**BURNER ADJUSTMENTS
(QUALIFIED TECHNICIANS ONLY)**

Flame Appearance and sooting

Proper flame appearance is a flame which is blue at the base and becomes yellowish-orange in the body of the flame. When the appliance is first lit, the entire flame may be blue and will gradually turn yellowish-orange during the first 15 minutes of operation. If after a short period the flame stays lowered blue, or if the flame is orange with evidence of sooting (black tip), the air shutter opening may need to be adjusted.

If the air shutter openings closed too far, sooting may develop. Sooting is indicated by black puffs developing at the tips of very long orange flames. Sooting results in black deposits forming on the logs, appliance inside surfaces and on exterior surfaces adjacent to the vent termination. Sooting is caused by incomplete combustion in the flames and lack of combustion air entering the air shutter opening. To achieve a warm yellowish-orange flame with an orange body that does not soot, the shutter opening must be adjusted between these two extremes.

Air Shutter Adjustment Guidelines

- If there is smoke or soot present, first check the log set positioning to ensure that the flames are not impinging on any of the logs. If the log set is properly positioned and a sooting condition still exists, then the air shutter opening should be increased.
- The more offsets in the vent system, the larger the air shutter opening will need to be.
- An appliance operated with the air shutter opened too far, may have flames that appear blue and transparent. These weak, blue and transparent flames are termed anemic.
- Propane models may exhibit flames which candle or appear stringy. If this is present and persists, adjust the air shutter to a more open position, then operate the appliance for a few more minutes to ensure that the flame normalizes and the flames do not appear sooty.

The following chart is provided to aid you in achieving the correct air shutter adjustment for your installation.

Air Shutter Adjustment Guidelines:		
Amount of Primary Air	Flame Color	Air Shutter Adjustment
If air shutter is closed too far →	Flame will be orange →	Air shutter gap should be increased
If air shutter is open too far →	Flame will be blue →	Air shutter gap should be decreased



Figure 10 - Burner Flame Appearance Model LMDV-3328 & LMDV-3530

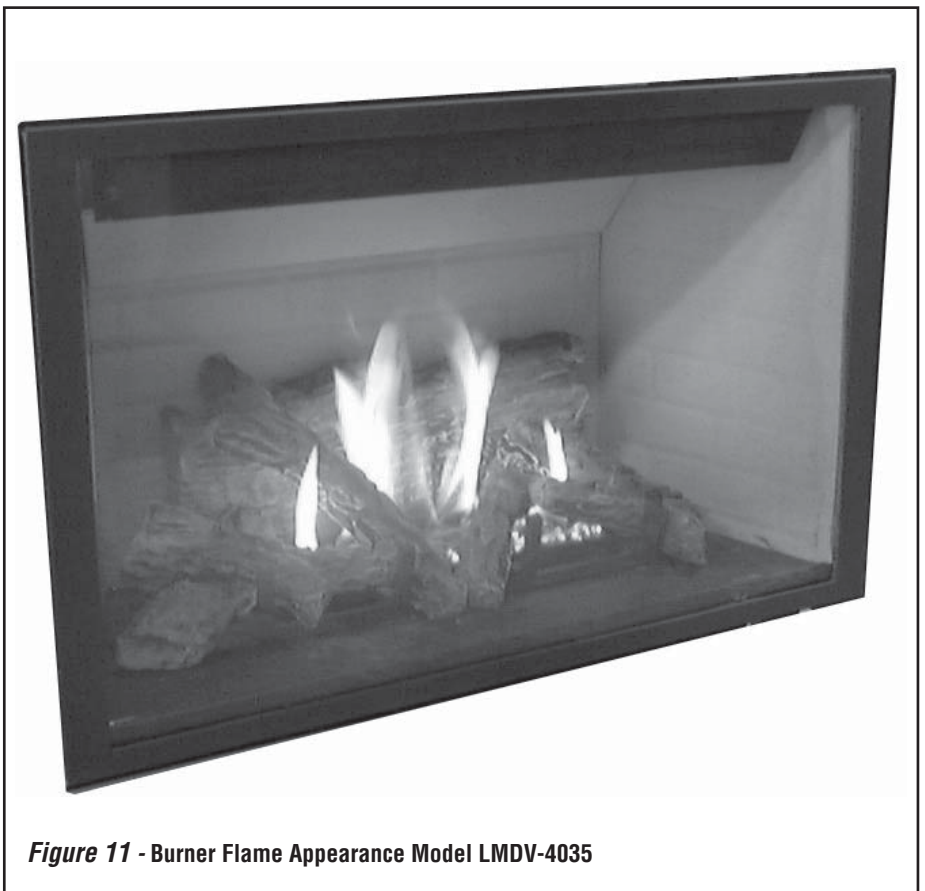

Figure 11 - Burner Flame Appearance Model LMDV-4035

NOTE: DIAGRAMS & ILLUSTRATIONS NOT TO SCALE.

Burner Air Shutter Adjustment Procedure

1. Locate adjustment rod and adjust air shutter to the standard setting as shown in **Figure 12** (adjustment rod is located in the lower control compartment). **Note:** Rotating the adjustment rod clockwise decreases air and counterclockwise increases air.
2. Light appliance (follow lighting procedure on lighting label in control compartment or see homeowners manual).
3. Allow the burner to operate for at least 15 minutes while observing the flame continuously to ensure that the proper flame appearance has been achieved (see **Figure 10 or 11**). If the following conditions are present, adjust accordingly.
 - If flame appears weak or sooty, adjust the air shutter, incrementally, to a more open position until the proper flame appearance is achieved.
 - If flame stays lowered blue, adjust the air shutter, incrementally, to a more closed position until the proper flame appearance is achieved.
4. Leave the control knob (off/pilot/on) in the ON position and the burner OFF/ON switch OFF (& remote switches, if applicable).
5. When satisfied that the burner flame appearance is normal, close the lower control compartment door.

WARNING

Air shutter adjustment should only be performed by a qualified professional service technician.

WARNING

Ensure front glass panel is in place and sealed during adjustment.

CAUTION

The air shutter door and nearby appliance surfaces are hot. Exercise caution to avoid injury while adjusting flame appearance.

CAUTION

Carbon will be produced if the air shutter is closed too much. Any damage due to carboning resulting from improperly setting the air shutter is not covered under the warranty.

Burner Air Shutter Adjustment

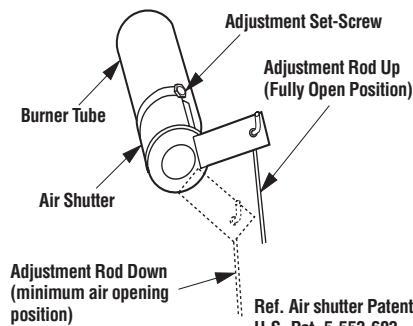

Main Burner Factory Air Shutter Opening Setting - Inches (millimeter)

Model	Natural Gas	Propane Gas
LMDVT-3328	1/16" (1.58 mm)	1/4" (6.35 mm)
LMDVR-3328	1/16" (1.58 mm)	1/4" (6.35 mm)
LMDV-3530	1/16" (1.58 mm)	5/16" (7.94 mm)
LMDV-4035	1/8" (3.18mm)	3/8" (9.53 mm)

Figure 12

Millivolt Appliance Checkout

The pilot flame should be steady, not lifting or floating. Flame should be blue in color with traces of orange at the outer edge.

The top 3/8" (10 mm) at the pilot generator (thermopile) and the top 1/8" minimum (tip) of the quick drop out thermocouple should be engulfed in the pilot flame. The flame should project 1" (25 mm) beyond the hood at all three ports. See **Figures 13 or 14**.

To light the burner, refer to the lighting instructions on **Pages 18 & 19**.

SIT MILLIVOLT PILOT ASSEMBLY

Proper Pilot Flame Appearance

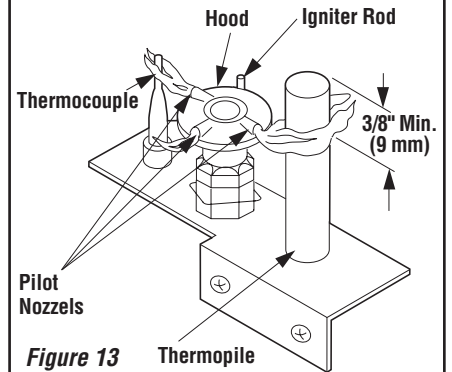

HONEYWELL MILLIVOLT PILOT ASSEMBLY

Proper Pilot Flame Appearance

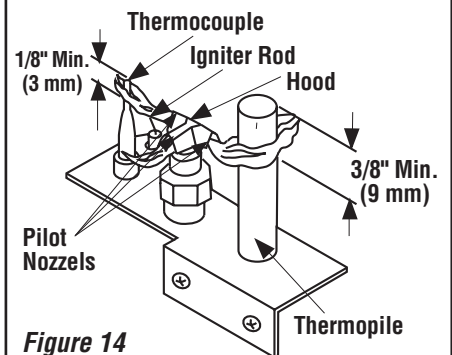

Electronic Appliance Checkout

To light the burner, refer to the lighting instructions on **Pages 19 & 20**. Ensure the igniter lights the pilot. The pilot flame should engulf the flame sensor as shown in **Figure 15**.

ELECTRONIC PILOT ASSEMBLY

Proper Pilot Flame Appearance

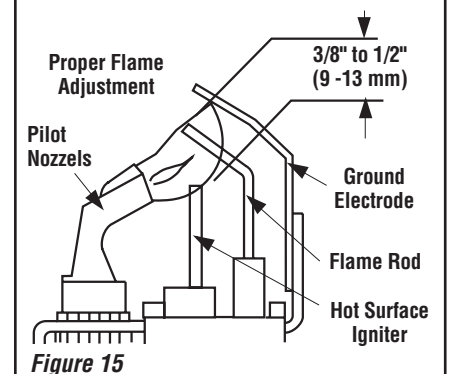

With proper care and maintenance, your appliance will provide many years of enjoyment. If you should experience any problem, first refer to the troubleshooting guide in this manual. If problem persists, contact your Lennox distributor.

NOTE: DIAGRAMS & ILLUSTRATIONS NOT TO SCALE.

WIRING DIAGRAMS

Wiring diagrams are provided here for reference purposes only. This information is also provided on schematics attached directly to the appliance on a pullout panel located within the control compartment.

CAUTION

Label all wires prior to disconnection when servicing controls. Wiring errors can cause improper and dangerous appliance operation.

Millivolt Wiring Diagram Schematic Representation Only

If any of the original wire as supplied must be replaced, it must be replaced with Type AWM 105° C - 18 gage wire.

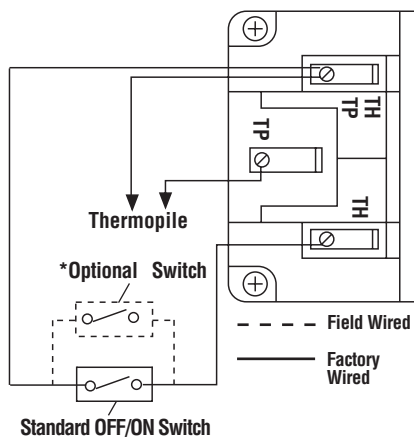

* Optional Kits Installed - OFF/ON wall switch, wall thermostat or remote control receiver. Note: Turn the appliance-mounted OFF/ON burner control switch to the OFF position if any of these kits are installed.

Figure 16

Electronic Wiring Diagram (Honeywell) Showing Blower Wiring for Optional FBK-100, FBK-200 & FBK-250 Kits Schematic Representation Only

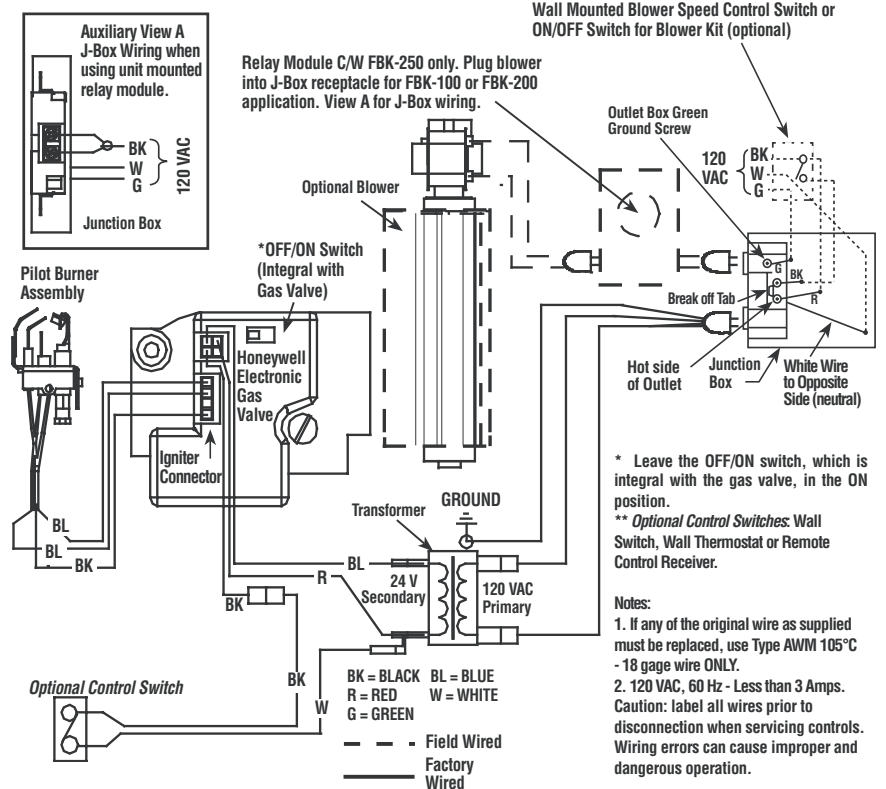

Figure 17

WARRANTY

Your gas appliance is covered by a limited twenty year warranty. You will find a copy of the warranty accompanying this manual. Please read the warranty to be familiar with its coverage.

Retain this manual. File it with your other documents for future reference.

PRODUCT REFERENCE INFORMATION

We recommend that you record the following important information about your fireplace. Please contact your Lennox dealer for any questions or concerns. For the number of your nearest Lennox dealer, please call 1-800-9-LENNOX.

Visit us at www.Lennox.com

REPLACEMENT PARTS

A complete parts list is found at the end of this manual. Use only parts supplied from the manufacturer.

Normally, all parts should be ordered through your Lennox distributor or dealer. Parts will be shipped at prevailing prices at time of order.

When ordering repair parts, always give the following information:

1. The model number of the appliance.
2. The serial number of the appliance.
3. The part number.
4. The description of the part.
5. The quantity required.
6. The installation date of the appliance.

If you encounter any problems or have any questions concerning the installation or application of this system, please contact your distributor, or Lennox directly:

LENNOX HEARTH PRODUCTS
1110 West Taft Avenue
Orange, CA 92865

Your Fireplace's Model Number _____
Your Fireplace's Serial Number _____
The Date On Which Your Fireplace Was Installed _____
The Type of Gas Your Fireplace Uses _____
Your Dealer's Name _____

NOTE: DIAGRAMS & ILLUSTRATIONS NOT TO SCALE.

ACCESSORY COMPONENTS

Product Reference Information

Cat. No.	Model	Ship. Weight	Ship. Volume
H3313	LMDVT-3328CNM	95 lb.	13.08 cu. ft.
H3314	LMDVT-3328CPM	95 lb.	13.08 cu. ft.
H3315	LMDVR-3328CNM	95 lb.	13.08 cu. ft.
H3316	LMDVR-3328CPM	95 lb.	13.08 cu. ft.
H3317	LMDVT-3328CNE	95 lb.	13.08 cu. ft.
H3318	LMDVR-3328CNE	95 lb.	13.08 cu. ft.
H3319	LMDV-3530CNM	113 lb.	15.75 cu. ft.
H3320	LMDV-3530CPM	113 lb.	15.75 cu. ft.
H3321	LMDV-3530CNE	113 lb.	15.75 cu. ft.
H3322	LMDV-4035CNM	147 lb.	20.18 cu. ft.
H3323	LMDV-4035CPM	147 lb.	20.18 cu. ft.
H3324	LMDV-4035CNE	147 lb.	20.18 cu. ft.

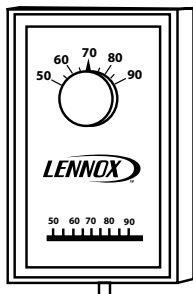

Wall Thermostat

The wall thermostat kit provides temperature control for optimum comfort.

Wall Thermostat, Millivolt		
Cat. No.	Model No.	Description
89L36	WTK	Wall Thermostat Kit, White

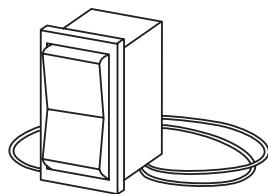

Unit-Mountable Rocker Switch

This rocker switch kit can be installed directly in the gas valve mounting bracket (millivolt gas valve equipped fireplaces) to provide On/Off operation in lieu of a wall switch.

Rocker Switch Kit		
Cat. No.	Model No.	Description
80L41	FRS	Rocker Switch Kit

(ref. Form # 750,037M)



Standard Remote Control System

The Model RCL (Standard) Remote Control System, features a simplistic OFF/ON control function for the fireplace. This model includes a hand-held transmitter, a remote receiver with wall-mount cover plate and all hardware required to install the unit. The remote receiver can be wall or hearth mounted.

The transmitter has ON and OFF functions that are activated by pressing either button on the face of the transmitter. When a button on the transmitter is pressed, a signal light illuminates briefly to verify that a signal has been sent.

The Model RCL is designed to operate with all millivolt ignition systems, as well as electronic ignition systems. It may be installed with use for either natural gas or propane gas appliances. The RCL offers ease of installation and allows you to execute on-off commands to the fireplace effortlessly with one simple motion.

The Model RCL comes complete with detailed operating instructions.

Remote Control Kit, Standard		
Cat. No.	Model No.	Description
H0249	RCL	Remote Control System (Standard)

(ref. Form # 750,127M)



Deluxe Remote Control System

The Model RCL-T (Deluxe) Remote Control System has all of the features of the standard system along with an added easy to read LCD screen which presents access to many enhancements, including; battery power level indicator, timer, mode of operation, thermostatic display including room temperature in either metric or English units, flame indicator and clock. Fully programmable, the Model RCL-T allows for virtual command over nearly all operational and temperature variables, using the hand held remote control transmitter.

The Model RCL-T (Deluxe) remote control system is installed in the same manner as the standard system, may be operated with electronic and millivolt systems with either natural gas or propane gas. The RCL-T comes complete with detailed operating instructions.

Remote Control Kit, Deluxe		
Cat. No.	Model No.	Description
H0251	RCL-STAT	Remote Control System (Deluxe)

(ref. Form # 750,129M)

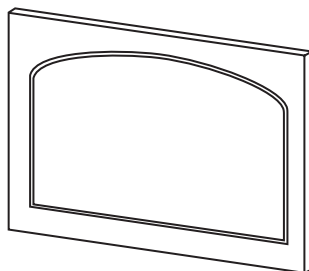

Arch Door Kits

The arch door kits are easy to install and do not require hardware to attach them to the standard door frame. The decorative arch kits can not be used in conjunction with the screen panel kit.

Arch Door Kit - Polished Brass		
Cat. No.	Model	Fireplace Model
98L05	ADK33CPB	LMDVT-3328, LMDVR-3328
26M43	ADK35CMPB	LMDV-3530
81L35	ADK40CPB	LMDV-4035

Arch Door Kit - Brushed Stainless Steel		
Cat. No.	Model	Fireplace Model
98L62	ADK33CBS	LMDVT-3328, LMDVR-3328
26M44	ADK35CMBS	LMDV-3530
98L69	ADK40CBS	LMDV-4035

(ref. Form # 750,021M)

NOTE: DIAGRAMS & ILLUSTRATIONS NOT TO SCALE.

ACCESSORY COMPONENTS

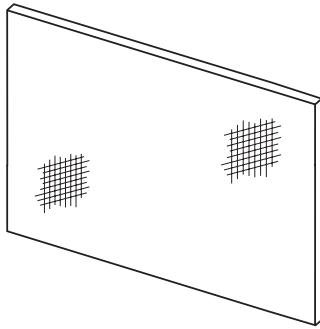

Screen Panel Kit

This easy to install optional screen installs over the standard glass enclosure panel to provide protection from direct contact with the hot glass surface. These screen panels cannot be used in conjunction with the arch door kits or door frame kits.

Screen Panel Kits		
Cat. No.	Model No.	Models Where Used
98L04	HG33	LMDVT-3328 LMDVR-3328
26M48	HG35M	LMDV-3530
26M49	HG40M	LMDV-4035

(ref. Form # 750,101M)

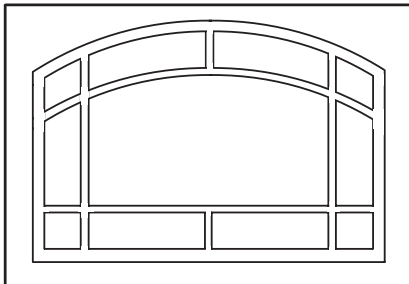

Decorative Arch Screen Panel Kit

This easy to install optional screen installs over the standard glass enclosure panel to provide protection from direct contact with the hot glass surface. These screen panels cannot be used in conjunction with the arch door kits or door frame kits.

Decorative Arch Screen Panel Kit			
Cat. No.	Model	Model	Model Series
H3592	DASPK33TI	33" Decorative Arch Screen Panel	LMDVT-3328 & LMDVR-3328
H3593	DASPK35TI	35" Decorative Arch Screen Panel	LMDV-3530
H3594	DASPK40TI	40" Decorative Arch Screen Panel	LMDV-4035

(ref. Form # 750,199M)

Style View Doors - Arch Design Kits			
Cat. No.	Model	Model	Model Series
H0858	AD35C	35" Arch Doors, Charcoal	LMDV-3530
H0859	AD35TI	35" Arch Doors, Textured Iron	
H0860	AD35SP	35" Arch Doors, Satin Pewter	
H0861	AD35AB	35" Arch Doors, Antique Brass	LMDV-4035
H0862	AD40C	40" Arch Doors, Charcoal	
H0863	AD40TI	40" Arch Doors, Textured Iron	
H0864	AD40SP	40" Arch Doors, Satin Pewter	
H0865	AD40AB	40" Arch Doors, Antique Brass	

Style View Doors - Arch Pane Design Kits			
Cat. No.	Model	Model	Model Series
H0930	APD35C	35" Arch Pane Doors, Charcoal	LMDV-3530
H0931	APD35TI	35" Arch Pane Doors, Textured Iron	
H0932	APD35SP	35" Arch Pane Doors, Satin Pewter	
H0933	APD35AB	35" Arch Pane Doors, Antique Brass	LMDV-4035
H0934	APD40C	40" Arch Pane Doors, Charcoal	
H0935	APD40TI	40" Arch Pane Doors, Textured Iron	
H0936	APD40SP	40" Arch Pane Doors, Satin Pewter	
H0937	APD40AB	40" Arch Pane Doors, Antique Brass	

Style View Doors - Square Design Kits			
Cat. No.	Model	Model	Model Series
H0946	SD35C	35" Sq. Doors, Charcoal	LMDV-3530
H0947	SD35TI	35" Sq. Doors, Textured Iron	
H0948	SD35SP	35" Sq. Doors, Satin Pewter	
H0949	SD35AB	35" Sq. Doors, Antique Brass	LMDV-4035
H0950	SD40C	40" Sq. Doors, Charcoal	
H0951	SD40TI	40" Sq. Doors, Textured Iron	
H0952	SD40SP	40" Sq. Doors, Satin Pewter	
H0953	SD40AB	40" Sq. Doors, Antique Brass	

Style View Doors - Square Pane Design Kits			
Cat. No.	Model	Model	Model Series
H0962	SPD35C	35" Sq. Pane Doors, Charcoal	LMDV-3530
H0963	SPD35TI	35" Sq. Pane Doors, Textured Iron	
H0964	SPD35SP	35" Sq. Pane Doors, Satin Pewter	
H0965	SPD35AB	35" Sq. Pane Doors, Antique Brass	LMDV-4035
H0966	SPD40C	40" Sq. Pane Doors, Charcoal	
H0967	SPD40TI	40" Sq. Pane Doors, Textured Iron	
H0968	SPD40SP	40" Sq. Pane Doors, Satin Pewter	
H0969	SPD40AB	40" Sq. Pane Doors, Antique Brass	

(ref. Form # 775,169M)

Style View Screen Doors -

These Style View screen doors come in 4 beautiful styles. They are easy to install and will not require hardware to attach them to the standard glass door frame. The screens prevent direct contact with the hot glass surface. The door includes heavy duty magnet door latches and functional twin-pane screen doors.

Arch Design

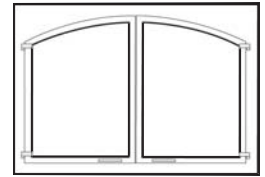

Arch Pane Design

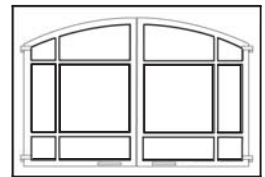

Square Design

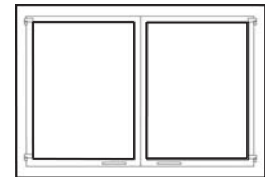

Square Pane Design

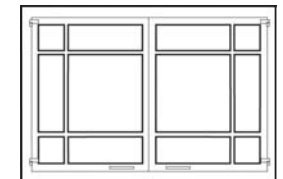

NOTE: DIAGRAMS & ILLUSTRATIONS NOT TO SCALE.

ACCESSORY COMPONENTS

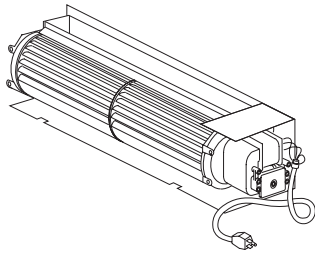

Forced Air Blower Kits		
Cat. No.	Model No.	Description
80L84	FBK-100	Blower, Standard (single speed)
80L85	FBK-200	Blower, Variable Speed (w/wall-mounted switch)
80L86	FBK-250	Blower, Variable Speed (w/unit-mounted switch)
94L89	FBK-100-36	Blower, Standard, 36 Pack
94L90	FBK-200-36	Blower Kit - Variable Speed with Wall Switch 36 Pack
H0543	FBK-250-36	Blower Kit - Variable Speed with Thermo Snap Switch 36 Pack

(ref. Form # 750,028M & 750,029M)

Forced Air Kit

The FBK-100 blower provides constant velocity forced air circulation. The FBK-200 assembly with variable speed, wall-mountable switch provides variable speed forced air circulation. The FBK-250 assembly with variable speed unit-mountable switch, also provides variable speed forced air circulation.

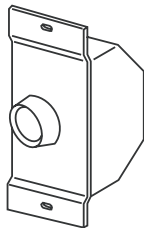

Variable Speed Wall Switch		
Cat. No.	Model No.	Description
045571H	VSWS	Rocker Switch Kit

Variable Speed Wall Switch

Provides variable speed control if optional blower kit is purchased.

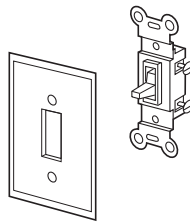

White Wall Switch Kit		
Cat. No.	Model No.	Description
85L87	FWSK	OFF/ON Wall Switch Kit

OFF/ON Wall Switch Kit

The OFF/ON wall switch kit may be used to control the operation of the fireplace burner. Install the OFF/ON wall switch in a convenient location near the fireplace.

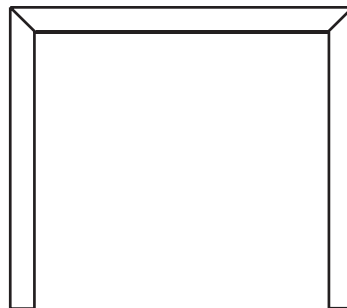

3 Piece Trim Kit		
Cat. No.	Model No.	Description
H0453	TK33PB3	33" Polished Brass, LMDVT-3328, LMDVR-3328
96K21	TK35PB3	35" Polished Brass, LMDV-3530
96K22	TK40PB3	40" Polished Brass, LMDV-4035
H1813	TK33BS3	33" Brushed Stainless, LMDVT-3328, LMDVR-3328
H1815	TK35BS3	35" Brushed Stainless, LMDV-3530
H1816	TK40BS3	40", Brushed Stainless, LMDV-4035
H4820	TK33C3	33" Charcoal, LMDVT-3328, LMDVR-3328
H4821	TK35C3	35" Charcoal, LMDV-3530
H4823	TK40C3	40" Charcoal, LMDV-4035

(ref. Form # 750,147M)

Polished Brass 3-Piece Trim Kit

This kit contains brass trim pieces used to finish the gaps between the wall board and the fireplace, providing the appliance a brass perimeter highlight. This kit contains the trim pieces and these instructions

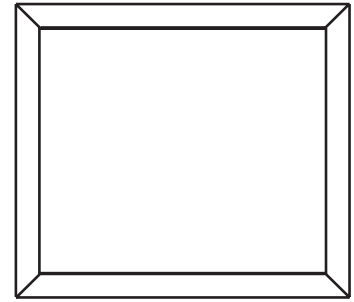

4 Piece Trim Kit		
Cat. No.	Model No.	Description
96K17	TK35PB4	35" 4 Piece Finish Trim Kit, Polished Brass, LMDV-3530
96K18	TK40PB4	40" 4 Piece Finish Trim Kit, Polished Brass, LMDV-4035

(ref. Form # ii-9299)

Polished Brass 4-Piece Trim Kit

This kit contains brass trim pieces used to finish the gaps between the wall board and the fireplace, providing the appliance a brass perimeter highlight. This kit contains the trim pieces and these instructions

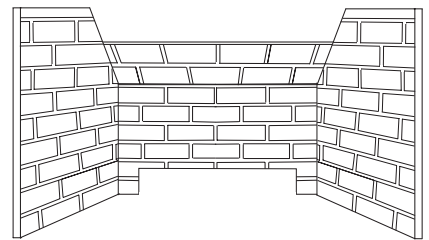

Brickaded Wall Liner Kits		
Cat. No.	Model No.	Description
H0912	MBLK-33T	Brick Liner Kit, Top Vent, LMDVT-3328
H0918	MBLK-33R	Brick Liner Kit, Rear Vent, LMDVR-3328
H0913	MBLK-35	Brick Liner Kit, Top/Rear, LMDV-3530
H0914	MBLK-40	Brick Liner Kit, Top/Rear, LMDV-4035

(ref. Form # 750,160M)

Brickaded Panel Liner Kit

The brickaded liner kits include ceramic panels as shown here. The panels have brick-like features in relief.

NOTE: DIAGRAMS & ILLUSTRATIONS NOT TO SCALE.

ACCESSORY COMPONENTS



Touch-Up Paint Kit

Repair of minor scratches and discoloration of the appliance charcoal painted surfaces may be accomplished with the touch-up paint kit.

Touch-Up Paint Kits (all models)		
Cat. No.	Model No.	Description
90L74	TPK-C	Touch-Up Paint (Charcoal)

(TPK-C ref. Form # 504,216M)

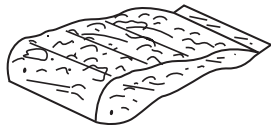

Decorative Firebox Accessories (all models)		
Cat. No.	Model No.	Description
88L53	FGE	Bag of Glowing Embers (1 oz. rockwool)
80L42	FDVS	Bag of Decorative Volcanic Stone

(FDVS ref. Form #750,010M)

Bag of Glowing Embers

Bag of Volcanic Stone

Replacement ember materials or volcanic stone are available for use with these appliances. Order kits as part of the periodic maintenance of the appliance.

* Assembled 8-Piece Louver Kits				
Polished Brass		Brushed Stainless		Models Where Used
Cat. #	Model	Cat. #	Model	
H1522	LK-400B	H1523	LK-400BS	LMDVT-3328 LMDVR-3328
H1524	LK-500B	H1525	LK-500BS	LMDV-3530
H1526	LK-600B	H1527	LK-600BS	LMDV-4035

(ref. Form # 750,166M)

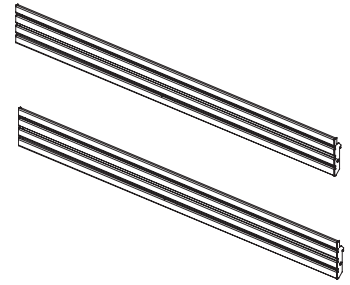

* Lennox Nameplate Logo, 12L15, is sold separately.

Polished Brass & Brushed Stainless Louvers Kits

These kits include a top 4-louver assembly and a bottom 4-louver assembly. They provide a touch of elegance. These kits can be retrofitted to previously installed appliances.

2- Piece Door Frame Kits				
Polished Brass		Brushed Stainless		Models Where Used
Cat. #	Model	Cat. #	Model	
98L18	2DFK33PB	98L19	2DFK33BS	LMDVT-3328 LMDVR-3328
26M88	2DFK35PB	26M91	2DFK35BS	LMDV-4035
26M89	2DFK40PB	26M92	2DFK40BS	LMDV-4035

(ref. Form # 750,098M)

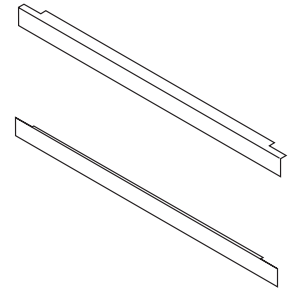

Polished Brass & Brushed Stainless 2-Piece Door Frame Kits

These kits are designed to attach directly to the front face of the appliance at the glass enclosure panel's top and bottom edges.

4 Piece Door Trim Kits				
Polished Brass		Brushed Stainless		Models Where Used
Cat. #	Model	Cat. #	Model	
98L22	4DFK33PB	98L23	4DFK33BS	LMDVT-3328 LMDVR-3328
26M82	4DFK35PB	26M85	4DFK35BS	LMDV-3530
26M83	4DFK40PB	26M86	4DFK40BS	LMDV-4035

(ref. Form # 750,098M)

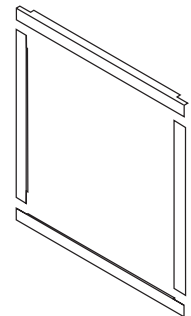

Door Frame Kits

A decorative door frame kit is available for use with these appliances. It is designed to attach directly to the front face of the appliance at the four edges of the glass enclosure panel resulting in the appearance of a picture frame.

Eyebrow Hood Kits				
Polished Brass		Brushed Stainless		Models Where Used
Cat. #	Model	Cat. #	Model	
98L10	EB33PB	98L11	EB33BS	LMDVT-3328 LMDVR-3328
96K67	EB35PB	88L49	EB35BS	LMDV-4035
96K68	EB40PB	88L50	EB40BS	LMDV-4035

* These hood kits replace the standard hood that comes with these fireplaces.

(ref. Form #504,142M)

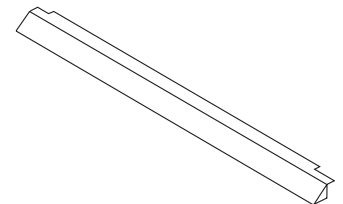

Polished Brass & Brushed Stainless Hood Kits

Attractive hoods are available in two styles. These hoods are designed to be fitted to the glass viewing sides of the appliance. In addition to providing an aesthetically pleasing appearance to your appliance installation, the hood reduces heat effects to decorative mantles and finish materials located above the fireplace opening. The hood kit replaces the standard hood that comes with these appliances and snaps into place. These kits can be retrofitted to previously installed appliances.

LIGHTING INSTRUCTIONS – HONEYWELL AND SIT MILLIVOLT GAS VALVE

FOR YOUR SAFETY READ BEFORE LIGHTING

WARNING: IF YOU DO NOT FOLLOW THESE INSTRUCTIONS EXACTLY, A FIRE OR EXPLOSION MAY RESULT CAUSING PROPERTY DAMAGE, PERSONAL INJURY OR LOSS OF LIFE.

- A. This appliance has a pilot which must be lighted with a piezo igniter. When lighting the pilot, follow these instructions exactly.
- B. **BEFORE OPERATING** smell all around the appliance area for gas. Be sure to smell next to the floor because some gas is heavier than air and will settle on the floor.
- WHAT TO DO IF YOU SMELL GAS**
- Extinguish any open flame.
 - Open windows.
 - Do not light any appliance.
 - Do not touch any electrical switches.
 - Do not use any phone in your building.
 - Immediately call your gas supplier from a neighbor's phone.
 - If your gas supplier cannot be reached, call the fire department.
- C. Use only your hand to push in or turn the gas control knob. Never use tools. If the knob will not push in or turn by hand, do not try to repair it, call a qualified service technician. Force or attempted repair may result in a fire or an explosion.
- D. Do not use this appliance if any part has been under water. Immediately call a qualified service technician to inspect the appliance and to replace any part of the control system and any gas control which has been under water.

LIGHTING INSTRUCTIONS

1. **STOP!** Read the safety information above on this Page.
2. Access the lower control compartment.
3. Turn remote wall switch to "OFF."
4. Verify main line shut-off valve is open.
5. Push in gas control knob slightly and turn clockwise to "OFF."
6. Wait five (5) minutes to clear out any gas. If you then smell gas, STOP! Follow "B" in the safety information above on this Page. If you do not smell gas, go to the next step.
7. Push in gas control knob slightly and turn counterclockwise to "PILOT."
8. Push in control knob all the way and hold in. Immediately light the pilot by triggering the spark igniter (pushing the button) until pilot lights. Continue to hold the control knob in for about 1 minutes after the pilot is lit. Release knob and it will pop back up. Pilot should remain lit. If it goes out, repeat steps 5 through 8.
 - If knob does not pop up when released, stop and immediately call your service technician or gas supplier.
 - If pilot will not stay lit after several tries, turn the control knob to "OFF" and call your service technician or gas supplier.
9. Turn gas control knob counterclockwise to "ON."
10. Close lower control compartment.

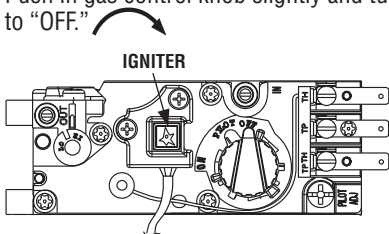

HONEYWELL
MILLIVOLT
GAS VALVE

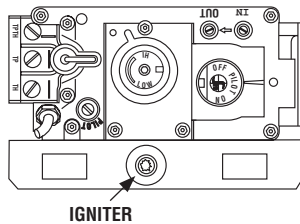

SIT
MILLIVOLT
GAS VALVE

Note: Knob cannot be turned from "PILOT" to "OFF" unless the knob is pushed in slightly. Do not force.

HONEYWELL
MILLIVOLT PILOT

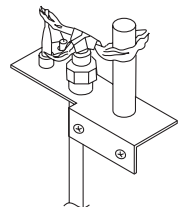

SIT
MILLIVOLT PILOT

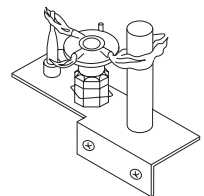

TO TURN OFF GAS TO APPLIANCE

1. Turn remote wall switch "OFF." The pilot will remain lit for normal service.
2. For complete shutdown, turn remote wall switch to "OFF."
3. Access the lower control compartment.
4. Depress gas control knob slightly and turn clockwise to "OFF." Do not force.
5. Close lower control compartment.

INSTRUCTIONS D'ALLUMAGE – VANNE GAZ MILLIVOLT HONEYWELL ET SIT

POUR VOTRE SÉCURITÉ, LISEZ CES INSTRUCTIONS AVANT L'ALLUMAGE

AVERTISSEMENT : SI VOUS NE SUIVEZ PAS CES INSTRUCTIONS À LA LETTRE, IL POURRAIT S'EN SUIVRE UN INCENDIE OU UNE EXPLOSION CAUSANT DES DOMMAGES MATÉRIELS, DES BLESSURES CORPORELLES OU MÊME DES PERTES DE VIE.

- A.** Cet appareil est muni d'une veilleuse qui doit être allumée avec un allumeur piézo-électrique. Lorsque vous allumez la veilleuse, suivre exactement ces instructions.
- B. AVANT L'ALLUMAGE:** Assurez-vous que vous ne détectez aucune odeur de gaz autour de l'appareil ainsi que près du sol; certains gaz, étant plus lourds que l'air, descendent au niveau du sol.
VOICI CE QUE VOUS DEVEZ FAIRE SI VOUS DÉCELEZ UNE ODEUR DE GAZ:
- Éteignez toute flamme visible.
 - Ouvrez les fenêtres.
 - N'allumez aucun appareil.
 - Ne touchez à aucun commutateur électrique.
 - Ne vous servez d'aucun téléphone dans votre édifice.
- Appelez immédiatement votre compagnie de gaz en utilisant le téléphone du voisin.
 - S'il vous est impossible de contacter votre compagnie de gaz, appelez le service des incendies.
- C.** N'utilisez que votre main pour manipuler le bouton de réglage du gaz. N'utilisez jamais d'outils. Si le bouton refuse de tourner ou de bouger, n'essayez pas de le réparer. Communiquez immédiatement avec un technicien de service qualifié. Toute tentative pour le forcer ou le réparer, risquerait de provoquer un incendie ou une explosion.
- D.** Ne vous servez pas de cet appareil si l'un de ses éléments a été immergé dans l'eau. Appelez immédiatement un technicien compétent pour faire inspecter l'appareil et remplacer toute pièce du système de réglage ou commande du gaz qui a été sous l'eau.

INSTRUCTIONS D'ALLUMAGE

- 1. ARRÊTEZ!** Lisez les consignes de sécurité au verso de cette plaque.
- Ouvrez le compartiment de contrôle du bas.
- Tournez l'interrupteur mural à la position d'arrêt "OFF".
- Assurez-vous que la soupape d'arrêt de la canalisation principale est ouverte.
- Enfoncez légèrement le bouton de réglage du gaz et tournez-le dans le sens des aiguilles d'une montre jusqu'à la position d'arrêt "OFF".

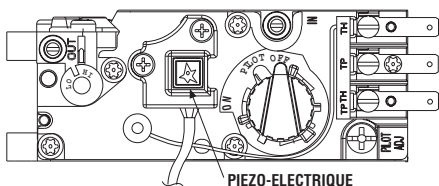

**VANNE GAZ
MILLIVOLT
HONEYWELL**

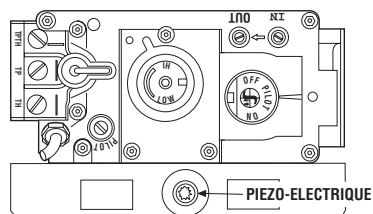

**VANNE GAZ
MILLIVOLT SIT**

Remarque: Il est impossible de tourner le bouton de "PILOT" à "OFF" à moins qu'il ne soit légèrement enfoncé. Ne le forcez pas.

6. Attendez cinq (5) minutes pour l'évacuation du gaz. Si vous décelez une odeur de gaz, ARRÊTEZ ! Retournez au point "B" des consignes de sécurité au verso de cette plaque. Si vous ne remarquez aucune odeur de gaz, passez à l'étape suivante.
7. Enfoncez légèrement le bouton de réglage du gaz et tournez-le en sens inverse des aiguilles d'une montre jusqu'à la position de veilleuse "PILOT".

8. Enfoncez le bouton de réglage jusqu'au fond et gardez-le enfoncé. Allumez immédiatement la veilleuse en déclenchant l'allume-gaz à étincelle (en poussant le bouton) jusqu'à ce que la veilleuse s'enflamme. Continuez de tenir le bouton de réglage enfoncé pendant environ 90 secondes après l'allumage de la veilleuse. Relâchez le bouton et il sortira subitement. La veilleuse devrait rester allumée. Si elle s'éteint, répétez les étapes 5 à 8 inclusivement.

**HONEYWELL
MILLIVOLT PILOT**

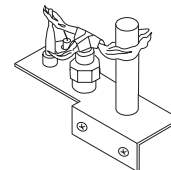

- Si le bouton ne sort pas automatiquement après avoir été relâché, arrêtez immédiatement et téléphonez à votre technicien de service ou à votre fournisseur de gaz.

- Si la veilleuse refuse de rester allumée après plusieurs tentatives, tournez le bouton de réglage jusqu'à sa position d'arrêt "OFF" et téléphonez à votre technicien de service ou à votre fournisseur de gaz.

**SIT
MILLIVOLT PILOT**

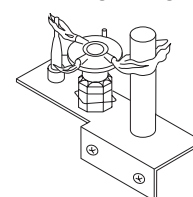

9. Tournez le bouton de réglage du gaz en sens inverse des aiguilles d'une montre jusqu'à sa position de marche "ON".
10. Fermez le compartiment de contrôle du bas.
11. Au besoin, rebrancher l'appareil au courant électrique et remettre l'interrupteur du brûleur principal à la position "ON" ou régler le thermostat à la température désirée.
12. Si l'appareil ne fonctionne pas, suivre les instructions intitulées "Pour fermer le gaz qui alimente l'appareil" et appeler un technicien ou le fournisseur de gaz.

POUR FERMER LE GAZ QUI ALIMENTE L'APPAREIL

1. Tournez l'interrupteur mural à la position d'arrêt "OFF". La veilleuse restera allumée jusqu'au retour du service normal.
2. Pour une fermeture complète, tournez l'interrupteur mural à la position d'arrêt "OFF".
3. Ouvrez le compartiment de contrôle du bas.
4. Enfoncez légèrement le bouton de réglage du gaz et tournez-le dans le sens des aiguilles d'une montre jusqu'à la position d'arrêt "OFF". Ne forcez pas le bouton.
5. Fermez le compartiment de contrôle du bas.

LIGHTING INSTRUCTIONS — ELECTRONIC

FOR YOUR SAFETY READ BEFORE LIGHTING

WARNING: IF YOU DO NOT FOLLOW THESE INSTRUCTIONS EXACTLY, A FIRE OR EXPLOSION MAY RESULT CAUSING PROPERTY DAMAGE, PERSONAL INJURY OR LOSS OF LIFE.

- A.** When lighting the appliance, follow these instructions exactly.
- B.** BEFORE OPERATING smell all around the appliance area for gas. Be sure to smell next to the floor because some gas is heavier than air and will settle on the floor.
- WHAT TO DO IF YOU SMELL GAS**
- Extinguish any open flame.
 - Open windows.
 - Do not light any appliance.
 - Do not touch any electrical switches.
 - Do not use any phone in your building.
- Immediately call your gas supplier from a neighbor's phone.
 - If your gas supplier cannot be reached, call the fire department.
- C.** Use only your hand to turn the gas control lever. Never use tools. If the lever will not turn by hand, do not try to repair it, call a qualified service technician. Force or attempted repair may result in a fire or an explosion.
- D.** Do not use this appliance if any part has been under water. Immediately call a qualified service technician to inspect the appliance and to replace any part of the control system and any gas control which has been under water.

LIGHTING INSTRUCTIONS

1. **STOP!** Read the safety information above on this Page.
2. Turn remote wall switch to "OFF."
3. Open lower control compartment door.
4. Verify main line shut-off valve is open.
5. Turn the OFF/ON switch to "OFF". Do not force.
6. Wait five (5) minutes to clear out any gas. If you then smell gas, STOP! Follow "B" in the safety information above on this Page. If you do not smell gas, go to the next step.
7. Turn the OFF/ON switch to "ON". Do not force.
8. Turn "ON" all electrical power to appliance (remote wall or appliance switch).
9. Close lower control compartment door.

Honeywell Electronic Gas Control Valve

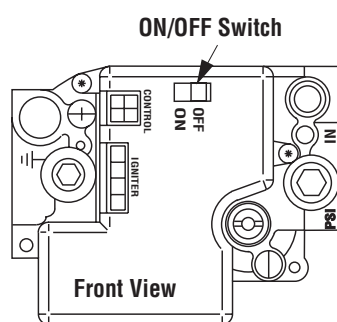

TO SHUT OFF

1. Turn off all electrical power to the appliance (remote wall switch).

TO TURN OFF GAS TO APPLIANCE

1. For complete shut-down, turn remote wall switch to "OFF."
2. Open lower control compartment door.
3. Turn the OFF/ON switch to "OFF". Do not force.
4. Close the main line shut-off valve.
5. Close lower control compartment door.

INSTRUCTIONS D'ALLUMAGE — ELECTRONIC

POUR VOTRE SÉCURITÉ, LISEZ CES INSTRUCTIONS AVANT L'ALLUMAGE

AVERTISSEMENT: SI VOUS NE SUIVEZ PAS CES INSTRUCTIONS À LA LETTRE, IL POURRAIT S'EN SUIVRE UN INCENDIE OU UNE EXPLOSION CAUSANT DES DOMMAGES MATÉRIELS, DES BLESSURES CORPORELLES OU MÊME DES PERTES DE VIE.

- A.** Lorsque vous allumez l'appareil, suivez exactement ces instructions.
- B. AVANT L'ALLUMAGE:** Assurez-vous que vous ne détectez aucune odeur de gaz autour de l'appareil ainsi que près du sol; certains gaz, étant plus lourds que l'air, descendent au niveau du sol.
- VOICI CE QUE VOUS DEVEZ FAIRE SI VOUS DÉCELEZ UNE ODEUR DE GAZ**
- Éteignez toute flamme visible.
 - Ouvrez les fenêtres.
 - N'allumez aucun appareil.
 - Ne touchez à aucun commutateur électrique.
 - Ne vous servez d'aucun téléphone dans votre édifice.
- Appelez immédiatement votre compagnie de gaz en utilisant le téléphone du voisin.
 - S'il vous est impossible de contacter votre compagnie de gaz, appelez le service des incendies.
- C.** N'utilisez que votre main pour manipuler l'interrupteur "ON/OFF" de la valve à gaz. N'utilisez jamais d'outils. Si l'interrupteur ne bouge pas manuellement, n'essayez pas de le réparer. Communiquez immédiatement avec un technicien de service qualifié. Toute tentative pour forcer l'interrupteur ou le réparer, risquerait de provoquer un incendie ou une explosion.
- D.** Ne vous servez pas de cet appareil si l'un de ses éléments a été immergé dans l'eau. Appelez immédiatement un technicien compétent pour faire inspecter l'appareil et remplacer toute pièce du système de réglage ou commande du gaz qui a été sous l'eau.

INSTRUCTIONS D'ALLUMAGE

- 1. ARRÊTEZ !** Lisez les consignes de sécurité au verso de cette plaque.
2. Tournez l'interrupteur mural à la position d'arrêt "OFF".
3. Ouvrez la porte du compartiment de contrôle du bas.
4. Assurez-vous que la soupape d'arrêt de la canalisation principale est ouverte.
5. Tournez la manette de réglage du gaz à la position d'arrêt "OFF".
6. Attendez cinq (5) minutes pour l'évacuation du gaz. Si vous décelez une odeur de gaz ARRÊTEZ ! Retournez au point "B" des consignes de sécurité au verso de cette plaque. Si vous ne remarquez aucune odeur de gaz, passez à l'étape suivante.
7. Tournez la manette de réglage du gaz jusqu'à la position de marche "ON". Ne la forcez pas.
8. Ouvrez le courant électrique ("ON") qui alimente l'appareil (interrupteur mural).
9. Fermez la porte du compartiment de contrôle du bas.
10. Au besoin, rebrancher l'appareil au courant électrique et remettre l'interrupteur principal du brûleur à la position "ON" ou régler le thermostat à la température désirée.
11. Si l'appareil ne se met pas en marche, suivre les instructions intitulées "Pour fermer le gaz qui alimente l'appareil" et appeler un technicien ou le fournisseur de gaz.

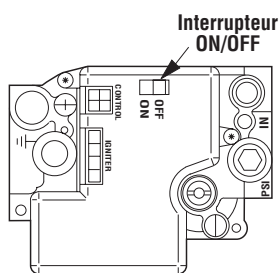

Vue de face

POUR ÉTEINDRE L'APPAREIL

1. Coupez tout le courant électrique qui alimente l'appareil (interrupteur mural).

POUR FERMER LE GAZ QUI ALIMENTE L'APPAREIL

1. Pour une fermeture complète, tournez l'interrupteur mural à la position d'arrêt "OFF".
2. Ouvrez la porte du compartiment de contrôle du bas.
3. Tournez la manette de réglage du gaz à la position d'arrêt "OFF". Ne la forcez pas.
4. Fermez la soupape d'arrêt de la canalisation principale.
5. Fermez la porte du compartiment de contrôle du bas.

MAINTENANCE SCHEDULE

Annually (Before the onset of the Burning Season)

MAINTENANCE TASK	ACCOMPLISHING PERSON	PROCEDURE
Inspecting/Cleaning Burner, Logs and Controls	Qualified Service Technician	Inspect valve and ensure it is properly operating. Check piping for leaks. Vacuum the control compartment, fireplace logs and burner area.
Check Flame Patterns and Flame Height	Qualified Service Technician	Refer to Figure 10 (LMDV-3328 & LMDV-3530) or Figure 11 (LMDV-4035) on Page 11 and verify the flame pattern and height displayed by the appliance conforms to the picture. Flames must not impinge on the logs. Ensure flames are steady (not lifting or floating).
Inspecting/Cleaning Pilot and Burner	Qualified Service Technician	Refer to Figure 13 (SIT Millivolt), Figure 14 (Honeywell Millivolt) or Figure 15 (Electronic) on Page 12 . Remove any surface build-up on pilot and burner assembly. Wipe the pilot nozzles, igniter/flame rod and hood. Ensure the pilot flame engulfs the flame sensor as shown.
Checking Vent System	Qualified Service Technician	Inspect the vent system at the top and at the base (within the firebox) for signs of blockage or obstruction. Look for any signs of dislocation or deterioration of the vent components. Note: Excessive condensation can cause corrosion of caps, pipe & fittings (excessive condensation can be caused by long lateral runs, too many elbows and/or exterior portions of the system being exposed to cold weather). Also inspect wall straps or plumbers's tape to ensure it is secure and in place.
Appliance Checkout	Qualified Service Technician	Perform the appropriate appliance checkout procedure detailed in this manual.
Replacing Rockwool Ember Materials	Homeowner/Qualified Service Technician	Remove old ember materials (rockwool) and vacuum the ember placement area. Place new embers as described and shown in Figures 8 & 9 .

Periodically (After the Burning Season)

MAINTENANCE TASK	ACCOMPLISHING PERSON	PROCEDURE
Cleaning Firebox Interior	Homeowner	Carefully remove logs, rockwool, volcanic stone and vermiculite. Vacuum out interior of the firebox. Clean firebox walls and log grate. Replace logs, rockwool, vermiculite and volcanic stone as detailed in this manual.
Check Flame Patterns and Flame Height	Homeowner	Refer to Figure 10 (LMDV-3328 & LMDV-3530) or 11 (LMDV-4035) on Page 11 and verify the flame pattern and height displayed by the appliance conforms to the picture. Flames must not impinge on the logs.
Checking Vent System	Homeowner	Inspect the vent system at the top and at the base (within the firebox) for signs of blockage or obstruction. Look for any signs of dislocation of the vent components.
Cleaning Front Glass Enclosure Panel	Homeowner	Clean as necessary following the directions provided in this manual. DO NOT TOUCH OR ATTEMPT TO CLEAN GLASS WHILE HOT.

TROUBLESHOOTING

Note: Before troubleshooting the gas control system, Ensure external gas shut off valve, located at gas supply inlet, (and wall switch, iff applicable), is in the "ON" position.

Important: Valve system troubleshooting should only be accomplished by a qualified service technician.

TROUBLESHOOTING GUIDE - MILLIVOLT GAS CONTROL SYSTEM

SYMPTOM	POSSIBLE CAUSES	CORRECTIVE ACTION
<p>1. Spark igniter will not light pilot after repeated triggering of igniter button.</p> <p>WARNING: if the pilot will not light after 1 minute of attempting, wait for at least 5 minutes for gas to clear before attempting again.</p>	A. Defective igniter (no spark at electrode).	Check for spark at electrode and pilot; if no spark and electrode wire is properly connected, replace igniter.
	B. Defective or misaligned electrode at pilot (spark at electrode).	Using a match, light pilot. If pilot lights, turn off pilot and trigger the igniter button again. If pilot lights, an improper gas mixture caused the bad lighting and a longer purge period is recommended. If pilot will not light—check gap at electrode and pilot—should be 1/8" to have a strong spark. If gap measures 1/8", replace pilot (see Figures 13 or 14 on Page 12).
	C. Gas supply pressure errant.	Check inlet gas pressure. It should be within the limits as marked on the rating plate.
	D. Pilot orifice plugged.	Clean or replace pilot orifice.
<p>2. Pilot will not stay lit after carefully following the lighting instructions.</p>	A. Defective pilot generator (thermocouple).	Check pilot flame, it must impinge on thermocouple (see Figures 13 or 14 on Page 12). Clean and/or adjust pilot for maximum flame impingement on thermocouple. Ensure that the connection between the valve and thermocouple are tight and secure.
<p>3. Pilot burning, no gas to burner, Valve knob "ON," and the (standard) burner OFF/ON switch is "ON." Read important note below.</p> <p>IMPORTANT NOTE: If an optional *remote switch is used for burner operation, if the standard burner OFF/ON switch is still installed on appliance it must be in the "OFF" position.</p> <p>* Optional remote switch kits - wall switch, wall thermostat or remote control.</p>	A. Wall switch or wires defective.	Check wall switch and wires for proper connections. Jumper wire across terminals at wall switch, if burner comes on, replace defective wall switch. If okay, jumper wires across wall switch wires at valve, if burner comes on, wires are faulty or connections are bad.
	B. Thermopile may not be generating sufficient millivolts.	Check thermopile with millivolt meter. Take reading at thermopile terminals of gas valve. Should read 325 millivolts minimum with optional wall switch "OFF." Replace faulty thermopile if reading is below specified minimum.
	C. Plugged burner orifice.	Check burner orifice for blockage and remove.
	D. OFF/ON Switch & *Remote Switch are in the "ON" position resulting in excessive resistance.	When turning on the burner using a *remote switch, ensure that the standard OFF/ON switch is in the "OFF" position. If both switches are in the ON position, it may result in excessive resistance (& millivolt drainage) and the burner may not come on.
<p>4. Frequent pilot/burner outage problem.</p>	A. Pilot flame may be too low or blowing (high) causing the pilot/valve safety to drop out.	Clean and/or adjust pilot flame for maximum flame impingement on thermocouple (see Figures 13 or 14 on Page 12).

TROUBLESHOOTING GUIDE - ELECTRONIC IGNITION SYSTEM

SYMPTOM	POSSIBLE CAUSES	CORRECTIVE ACTION
<p>1. Burner will not light.</p>	A. Faulty Valve System.	See Below.
	B. "OFF/ON" or wall switch defective.	Disconnect the two black wires from the wire nuts. Test switch(s) for continuity with a multimeter. If continuity is not indicated, switch(s) is defective and must be replaced. Note: Before replacing "OFF/ON" switch, Ensure to check wiring for loose connections or broken wires and repair as needed.
<p>2. Burners come "ON," then turns "OFF."</p>	A. Burner orifice plugged.	Check main burner orifice(s) for blockage. Clean or replace.
	B. Obstructed vent system.	Check vent system for obstructions.

TROUBLESHOOTING PROCEDURE - ELECTRONIC IGNITION SYSTEM

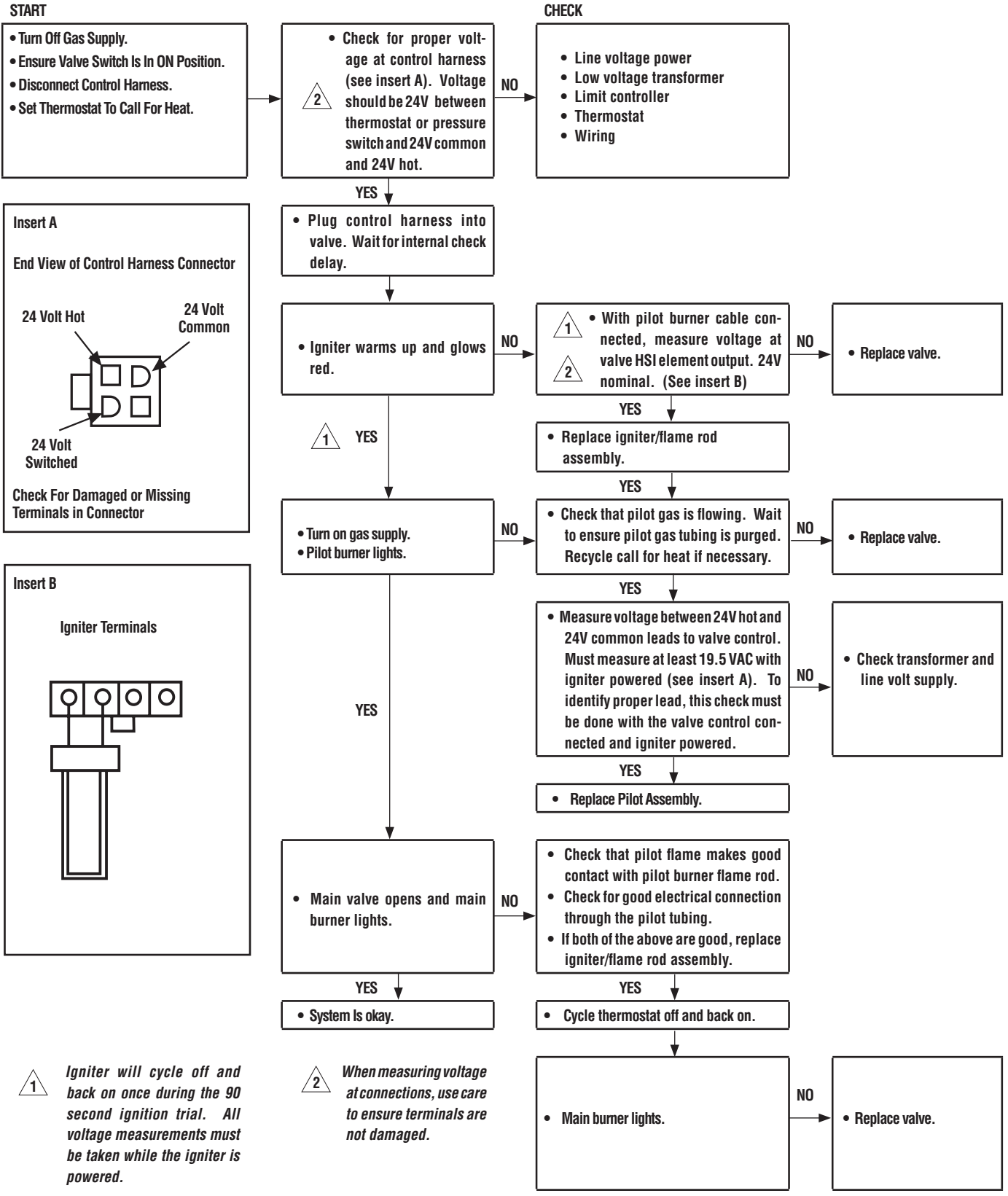

REPLACEMENT PARTS LIST

Item #	Description	LMDVT-3328 & LMDVR-3328		LMDV-3530		LMDV-4035	
		Part No.	Qty.	Part No.	Qty.	Part No.	Qty.
1	Hood	H4574	1	97K51	1	97K52	1
2	Louver Assembly, Top, Charcoal	H3375	1	H3376	1	H3377	1
3	*Louver Assembly, Bottom, Charcoal	H3378	1	H3379	1	H3380	1
4	Enclosure, Glass Front (Complete)	H4575	1	H4864	1	H3724	1
5	Nameplate, Lennox	12L15	1	12L15	1	12L15	1
6	Latch	69L21	2	69L21	2	69L21	2
7	Log Set (Complete)	H3366	1	H3366	1	H3365	1
8	Burner Assembly	24M58	1	24M58	1	24M59	1
9	Orifice, Main Burner - Natural Gas	39L66	1	60J80	1	24M10	1
9	Orifice, Main Burner - Propane Gas	99K78	1	12L52	1	21L01	1
10	Bag of Glowing Embers (Rockwool)	88L53	1	88L53	1	88L53	1
10	Bag of Decorative Volcanic Stone	80L42	1	80L42	1	80L42	1
10	Bag of Vermiculite	H3696	1	H3696	1	H3696	1
11	Gas Line Flexible Connector	93L32	1	93L32	1	93L32	1

* Lennox Nameplate Logo, 12L15, is sold separately.

Gas Controls - SIT Millivolt					
		Natural Gas		Propane Gas	
		Part No.	Qty.	Part No.	Qty.
12	Gas Valve, SIT	H1657	1	88J53	1
13	Piezo Igniter (w/wire)	91K94	1	91K94	1
14	Pilot Assembly	69L17	1	69L18	1
15	Pilot Generator	60J79	1	60J79	1
16	Thermocouple	74L57	1	74L57	1
17	Pilot Tube	74L56	1	74L56	1
18	Electrode and Cable	74L58	1	74L58	1
19	Pilot Shield	H3737	1	H3737	1

Gas Controls - Honeywell Millivolt					
		Natural Gas		Propane Gas	
		Part No.	Qty.	Part No.	Qty.
20	Gas Valve, Honeywell	24M12	1	82L87	1
21	Piezo Igniter	24M89	1	24M89	1
22	Pilot Assembly	67L70	1	67L70	1
23	Pilot Generator	60J79	1	60J79	1
24	Thermocouple	67L67	1	67L67	1
25	Pilot Tube	67L68	1	67L68	1
26	Electrode and Cable	67L87	1	67L87	1
27	Pilot Shield	H3737	1	H3737	1

Gas Controls - Honeywell Electronic					
		Natural Gas		Propane Gas	
		Part No.	Qty.	Part No.	Qty.
28	Gas Valve, Honeywell	62L18	1	62L19	1
29	Pilot Assembly	62L14	1	62L15	1
30	Transformer	42J32	1	42J32	1
31	Igniter Assembly (Kit)	87L54	1	87L54	1
32	Pilot Shield	H1596	1	H1596	1

REPLACEMENT PARTS

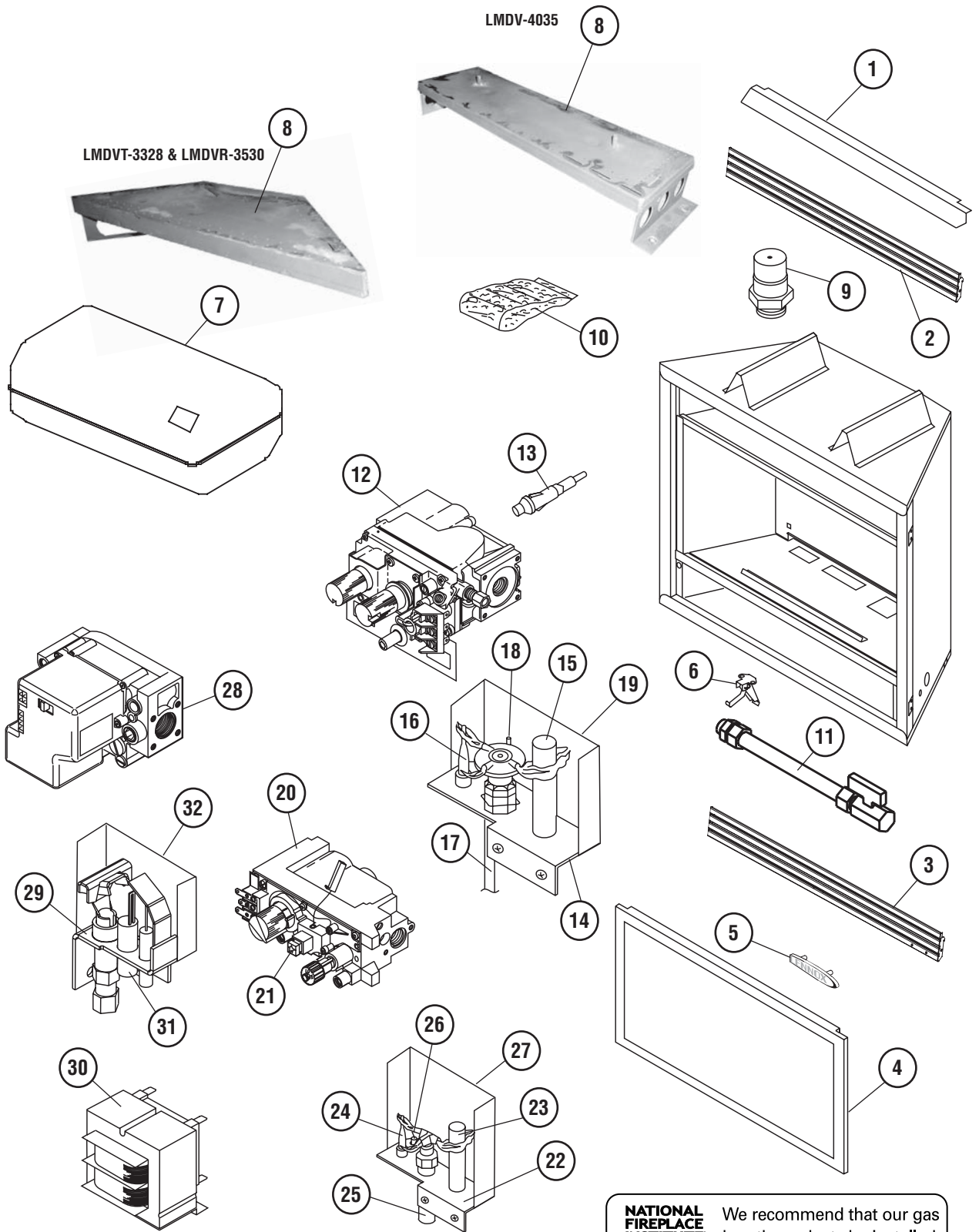

NATIONAL FIREPLACE INSTITUTE

CERTIFIED
www.nficertified.org

We recommend that our gas hearth products be installed and serviced by professionals who are certified in the U.S. by the National Fireplace Institute® (NFI) as NFI Gas Specialists.

NOTE: DIAGRAMS & ILLUSTRATIONS NOT TO SCALE.

NOTES

NOTE: DIAGRAMS & ILLUSTRATIONS NOT TO SCALE.

Lennox Hearth Products reserves the right to make changes at any time, without notice, in design, materials, specifications, prices and also to discontinue colors, styles and products. Consult your local distributor for fireplace code information.

Printed in U.S.A. © 2005 by LENNOX HEARTH PRODUCTS

P/N 875,028M REV. D 05/2006



HEARTH PRODUCTS

1110 West Taft Avenue • Orange, CA 92865