

This Owner's Manual is provided and hosted by [Appliance Factory Parts](#).



# WHIRLPOOL DU9400XY1 Owner's Manual

[Shop genuine replacement parts for WHIRLPOOL  
DU9400XY1](#)



[Find Your WHIRLPOOL Dishwasher Parts - Select From 1211 Models](#)

----- Manual continues below -----



# Use And Care

## G U I D E



<b>A Note To You</b>	<b>2</b>
<b>Important Safety Instructions</b>	<b>3</b>
<b>Parts And Features</b>	<b>4</b>
<b>Using Your Dishwasher</b>	<b>5</b>
<b>Loading Your Dishwasher</b>	<b>19</b>
<b>Caring For Your Dishwasher</b>	<b>23</b>
<b>Common Dishwashing Problems</b>	<b>24</b>
<b>If You Need Assistance Or Service</b>	<b>27</b>
<b>Warranty</b>	<b>32</b>

**1-800-253-1301**

Call us with questions or comments.

**9400 SERIES DISHWASHERS**

## A NOTE TO YOU

# A Note To You

### Thank you for buying a Whirlpool® appliance.

You have purchased a quality, *world-class* home appliance. Years of engineering experience have gone into its manufacturing. To ensure that you will enjoy many years of trouble-free operation, we have developed this Use and Care Guide. It is full of valuable information on how to operate and maintain your appliance properly and safely. Please read it carefully. Also, please complete and mail the Ownership Registration Card provided with your appliance. This will help us notify you about any new information on your appliance.

### Your safety is important to us.

This guide contains safety symbols and statements. Please pay special attention to these symbols and follow any instructions given. Here is a brief explanation of the use of each symbol.

#### WARNING

This symbol will help alert you to such dangers as personal injury, burns, fire and electrical shock.

#### CAUTION

This symbol will help you avoid actions which could cause product damage (scratches, dents, etc.) and damage to your personal property.

### Our Consumer Assistance Center number, 1-800-253-1301, is toll-free, 24 hours a day.

If you ever have a question concerning your appliance's operation, or if you need service, first see "If You Need Assistance Or Service" on page 27. If you need further help, feel free to call our Consumer Assistance Center. When calling, you will need to know your appliance's complete model number and serial number. You can find this information on the model and serial number label (see diagram on page 4). For your convenience, we have included a handy place below for you to record these numbers, the purchase date from the sales slip and your dealer's name and telephone number. Keep this book and the sales slip together in a safe place for future reference.

Model Number \_\_\_\_\_

Dealer Name \_\_\_\_\_

Serial Number \_\_\_\_\_

Dealer Phone \_\_\_\_\_

Purchase Date \_\_\_\_\_

# Important Safety Instructions

## **⚠ WARNING**

To reduce the risk of fire, electrical shock, or injury when using your dishwasher, follow basic precautions including the following:

- Read all instructions before using the dishwasher.
- Use your dishwasher only for the uses described in this manual.
- **DISHWASHER MUST BE ELECTRICALLY GROUNDED.** Read the Installation Instructions for details.
- When discarding an old dishwasher, always remove the door to prevent accidental entrapment or suffocation.
- Use **ONLY** detergents and rinse agents recommended for use in a dishwasher.
- Store dishwasher detergent in a cool, dry place **WHERE CHILDREN CAN'T REACH IT.**
- When loading items to be washed:
  - Load sharp items and knives with the handles up to reduce risk of cut-type injuries.
  - Locate sharp items and knives so that they are not likely to damage the door or tub.
- **DO NOT** let children play in or on the dishwasher.
- **DO NOT** reach into the area below the bottom rack until the heating element has cooled for at least 20 minutes.
- **DO NOT** wash plastic items unless marked "Dishwasher Safe" or the equivalent. If not marked, check manufacturer's recommendations.
- **DO NOT** use your dishwasher unless all enclosure panels are properly in place.
- **DO NOT** sit on, stand on or abuse the dishwasher door or dish racks.
- **DO NOT** tamper with controls.
- If hot water has not been used recently (usually two weeks or longer), hydrogen gases may build up in the water heater and the hot water pipes. **HYDROGEN GAS IS EXPLOSIVE.** To prevent injury or damage, before using your dishwasher, turn on all hot water faucets and allow water to run for several minutes. This will allow gases to escape. Do not smoke or use any open flame near the faucet while it is open.
- **DO NOT** store or use gasoline or other flammable vapors and liquids in the vicinity of this or any other appliance. The fumes can create a fire hazard or explosion.
- Disconnect electrical power to the dishwasher before attempting to service.

– SAVE THESE INSTRUCTIONS –

## **Help us help you**

Please:

- Have your dishwasher installed by a qualified installer.
- Install where dishwasher is protected from the elements.
- Install and level dishwasher on a floor that will hold the weight, and in an area suitable for its size and use.
- Properly connect dishwasher to electricity, water and drain.\*
- Remove all shipping plugs from hoses and connectors (such as drain connector on a disposer) before installing.\*
- Remove all hang tags and temporary labels.
- Make sure dishwasher is not used by anyone unable to operate it properly.
- Properly maintain dishwasher. See page 23.

\* See Installation Instructions for complete information.

## PARTS AND FEATURES

# Parts And Features

This section contains captioned illustrations of your appliance. Use them to become familiar with the location and appearance of all parts and features.

**NOTE:** The drawings in this book may vary from your dishwasher model. They are designed to show the different features of all models covered by this book. Your model may not include all features.

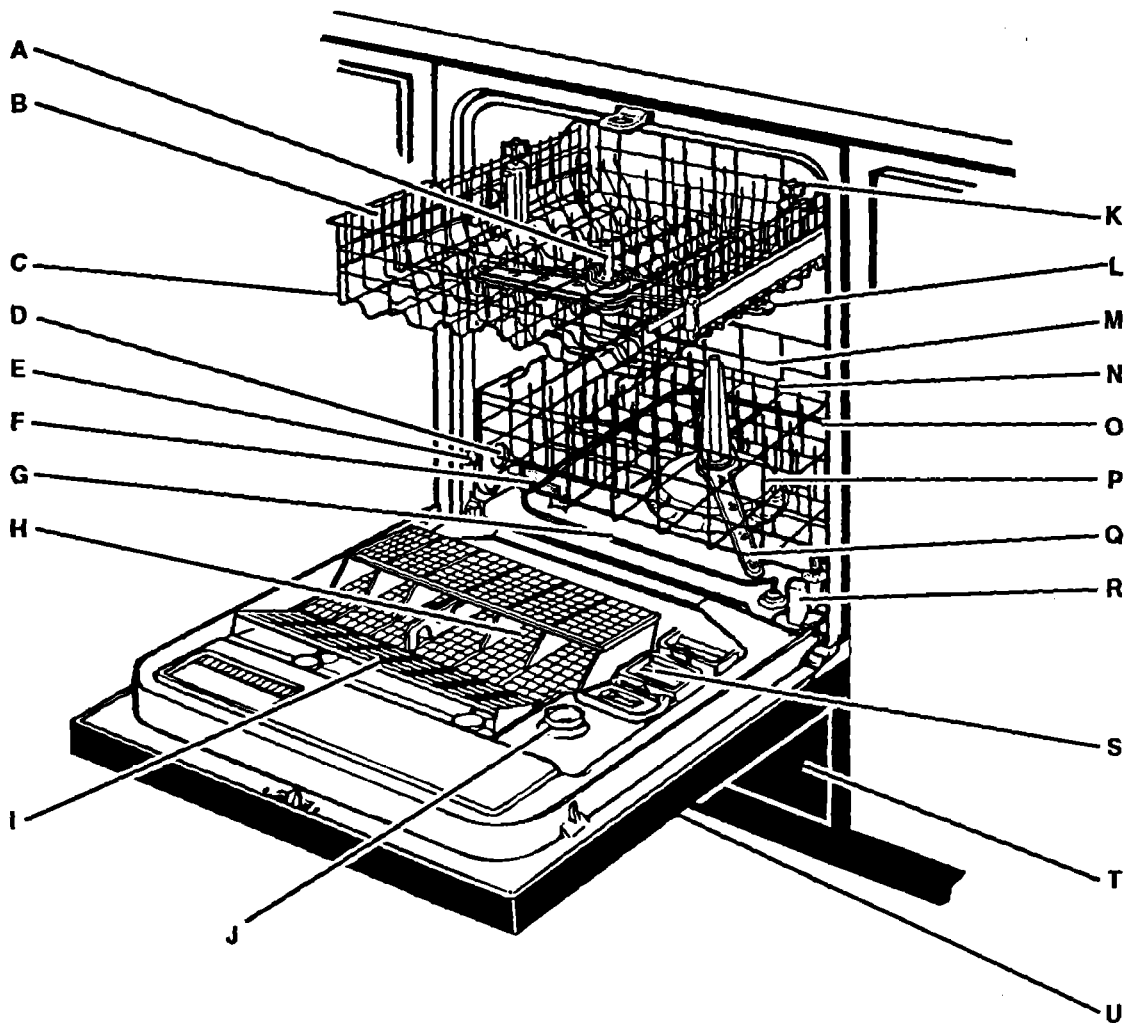

- A Third level wash
- B Extra-capacity fold down shelves (on some models)
- C Top rack
- D Water inlet opening
- E Rack bumper
- F Bottom rack
- G Heating element
- H Silverware basket
- I Cutlery basket
- J Rinse agent dispenser
- K Top rack adjuster

- L Upper spray arm
- M Fold down divider (on some models)
- N Spray tower
- O Model and serial number label (on right side)
- P POWER CLEAN™ module
- Q Lower spray arm
- R Overfill protector
- S Detergent dispenser
- T Access panel
- U Door color panel

**Control panel**

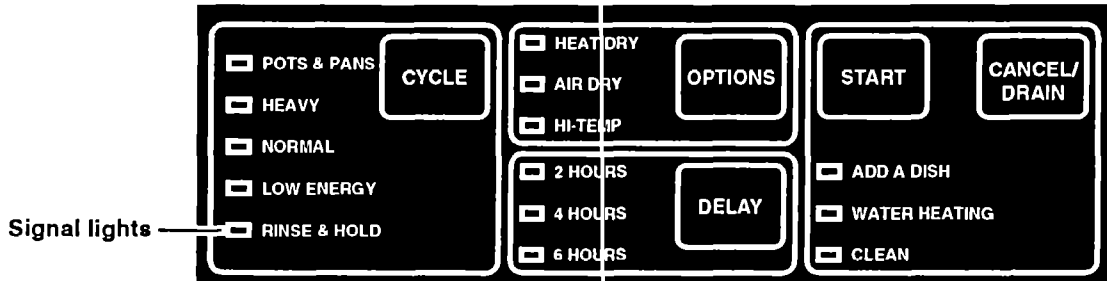

# Using Your Dishwasher

In This Section		Page	Page
Using your dishwasher for the first time .....		5	The WATER HEATING signal light .. 10
Before starting your dishwasher .....		6	The CLEAN signal light .....
Starting your dishwasher .....		6	Flashing signal lights .....
Starting your dishwasher using delay wash .....		6	Cycle selection chart .....
Using cycle pause .....		7	What happens in each option .....
Changing a cycle setting .....		8	Using the detergent dispenser .....
Adding a dish during a cycle .....		8	Using the rinse agent dispenser .....
The CANCEL/DRAIN pad .....		9	Quiet operating tips .....
Control panel lock-out feature .....		9	Water temperature tips .....
Adjusting the beeping sound .....		9	Energy saving tips .....
			Special tips on dishwasher use .....







Operating your dishwasher properly enables you to obtain the best possible results. This section explains proper dishwasher operation.

## Using your dishwasher for the first time

- When your dishwasher is first installed, the signal lights will flash rapidly in order. The signal lights will also flash after a power failure. Press the **CANCEL/DRAIN** pad **twice** to clear the signal lights.
- Five control pads and the signal lights allow you to set and check the dishwasher's function.
- A "beep" sounds each time a pad is pressed under normal conditions.
- The dishwasher is preset for the Normal cycle with the Heat Dry option. After each use, the dishwasher remembers the last cycle and options used. The next time the display is lit up for selection, it will show the last selection that was used.

## USING YOUR DISHWASHER

### Before starting your dishwasher

1. Properly load the top rack, bottom rack, silverware basket, and the cutlery basket. See pages 19-22. 
2. Spin both spray arms with both racks in place to make sure nothing prevents arms from turning freely. 
3. Add detergent. See pages 14 and 15. 
4. Check the rinse agent dispenser. See pages 15 and 16. 
5. Push door firmly when closing and it will automatically latch. Avoid touching control pads while door is open or being closed. 
6. Run hot water at sink nearest dishwasher until water is hot. Turn off water. 

### Starting your dishwasher

The dishwasher will wash and dry dishware according to the selections you make on the control panel.

1. Press the **START** pad once to display the cycle and options. Skip to Step 4 if you want to run the cycle and options shown by the lights.
2. Press the **CYCLE** pad until the cycle you want is indicated by a signal light. Each press of the **CYCLE** pad advances the signal light to the next cycle.
3. Press the **OPTIONS** pad until the option you want is indicated by a signal light. Each press of the **OPTIONS** pad advances the signal light to the next option.
4. Press the **START** pad again.

**NOTE:** Cycle and option selections are canceled by a power failure.

PRESS

START

PRESS

CYCLE

PRESS

OPTIONS

PRESS

START

### Starting your dishwasher using delay wash

The **DELAY** pad allows you to delay the start of a cycle for 2, 4, or 6 hours after loading the dishwasher. For example, use **DELAY** to run the dishwasher during off-peak hours of electrical use.

1. Press the **DELAY** pad once to display the last cycle and options selection.

PRESS

DELAY

## USING YOUR DISHWASHER

2. Select a new cycle and option(s), if desired.

SELECT

CYCLE

OPTIONS

3. Press the DELAY pad again to select a 2 hour delay. The 2 HOURS signal light will come on. Pressing the DELAY pad repeatedly will select (in order) 4 hours, 6 hours, no delay, then 2 hours, etc. If no delay is selected, all delay signal lights will be off.

PRESS

DELAY

4. After 2 hours, the signal light will turn off and the dishwasher will start. If 4 hours or 6 hours were chosen, the signal light for the next shorter delay time will turn on and continue to count down. This continues until the delay time ends and the dishwasher starts.

2 HOURS

4 HOURS

6 HOURS

### NOTE:

- You may press the START pad at any time during the delay if you want the dishwasher to start immediately.
- You may press the CANCEL/DRAIN pad to cancel the delay and clear the delay signal light.
- You may add items to the load at any time during the delay. **Close the door firmly to latch it.**

---

## Using cycle pause

You can stop a cycle at any time for up to 10 minutes.

1. Press the DELAY pad. Any signal lights that are on will flash slowly until the cycle restarts after 10 minutes.

PRESS

DELAY

2. The cycle can be restarted sooner by pressing the START pad.

PRESS

START

## Changing a cycle setting

You can change a setting anytime during any cycle.

### During the first minute of a cycle

During the first minute of a cycle the dishwasher is filling with water and the wash action has not started.

1. Select a new cycle and option(s).
2. Be sure the detergent dispensers are filled properly for the new cycle.

SELECT

CYCLE

OPTIONS

### After the first minute of a cycle:

1. Press the CANCEL/DRAIN pad. The dishwasher will go into a 2 minute drain cycle, if needed.
2. Select a new cycle and option(s).
3. Be sure the detergent dispensers are filled properly for the new cycle.
4. Press the START pad. The dishwasher will start the new cycle.

PRESS

CANCEL/  
DRAIN

SELECT

CYCLE

OPTIONS

PRESS

START

## Adding a dish during a cycle

You can add an additional item to the dishwasher anytime while the ADD A DISH signal light is on.

1. Lift up on the door latch to unlatch the door and stop the cycle. Wait a moment for the spray action to stop before opening the door.
2. Open the door and add the dish.
3. Close the door. **Do not latch it.** Wait 30 seconds for air in the dishwasher to warm up. This helps reduce the amount of moisture that can come from the vent when restarting the cycle.
4. Press door in to latch it. The dishwasher will start where it stopped.

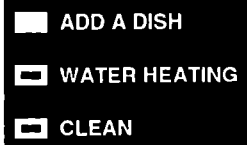

**NOTE:** The cycle will be cancelled if you accidentally touch the CANCEL/DRAIN pad while closing the door. Press the CANCEL/DRAIN pad again, then press the START pad to restart the cycle.

## The CANCEL/DRAIN pad

**CANCEL/  
DRAIN**

The CANCEL/DRAIN pad allows you to cancel a cycle, to clear the signal lights or to make a new selection.

- Press CANCEL/DRAIN while the dishwasher is washing to start a 2 minute drain. (If the dishwasher has not been started or is not washing, it will clear the display.)
  - Press CANCEL/DRAIN again to stop the drain.
  - Press CANCEL/DRAIN again to start a 2 minute drain, if there is still water in the dishwasher.
- NOTE:** A small amount of water remaining in the dishwasher is normal. See page 27.

## Control panel lock-out feature

This feature lets you lock-out the function of the control pads (except to cancel or pause a cycle that is running). When the control panel is locked-out, the dishwasher cannot be started and a running cycle cannot be changed.

### To use the lock-out feature

1. Press and hold the OPTIONS and DELAY pads until the CLEAN signal light flashes.
2. Release the pads. The CLEAN signal light will stop flashing.

PRESS



YOU SEE



### To turn off the lock-out feature

1. Press and hold the OPTIONS and DELAY pads until the CLEAN signal light turns on and stays on.
2. Release the pads. The CLEAN signal light will turn off.

PRESS



YOU SEE



## Adjusting the beeping sound

Each time a control pad is pressed, a single "beep" sound is made. A double beep means one of the extra features was selected (such as control panel lock-out) or the wrong control pad was pressed.

### To turn off the beep

1. Press and hold the OPTIONS pad until the CLEAN signal light flashes.
2. Release the pad. The CLEAN signal light will turn off.

PRESS



YOU SEE



**NOTE:** A power failure will reset this feature. You will have to repeat the above steps.

### To turn the beep back on

1. Press and hold the OPTIONS pad until the CLEAN signal light turns on and stays on.
2. Release the pad. The CLEAN signal light will turn off.

PRESS



YOU SEE



## The WATER HEATING signal light

The WATER HEATING signal light comes on during the water heating portion of the Pots & Pans cycle. The signal light will also come on during the water heating portion of other cycles when the Hi-Temp option is selected.

The WATER HEATING signal light will flash at the end of the cycle if the water did not heat to 135°F (57°C). If you want to make sure the water gets heated to 135°F (57°C), use the Hi-Temp option (see page 13).

When the signal light is on, water is being heated. The heating time is based on the temperature of the water supply as it enters the dishwasher. The cooler the water, the longer the heating time. The WATER HEATING signal light will go off when the water temperature reaches 135°F (57°C).



## The CLEAN signal light

The CLEAN signal light comes on at the end of a cycle to show that the load is clean. It will stay on until CANCEL/DRAIN or any other control pad is pressed.

As an option, you can have the CLEAN light turn off the first time you open the door after a cycle is finished:

1. Press and hold the CYCLE pad until the CLEAN signal light starts flashing.
2. Release the pad. The CLEAN signal light will turn off.

**NOTE:** A power failure will reset this feature. You will have to repeat the above steps.

To have the signal light stay on again when the door is opened:

1. Press and hold the CYCLE pad until the CLEAN signal light turns on.
2. Release the pad. The CLEAN signal light will turn off.



**PRESS**      **YOU SEE**



**PRESS**      **YOU SEE**



## Flashing signal lights

The signal lights will flash rapidly in order when your dishwasher is first installed and connected to electricity. The signal lights will also flash following a power failure. Press the CANCEL/DRAIN pad twice to clear the signal lights.

**PRESS TWICE**

**CANCEL/  
DRAIN**

## Cycle selection chart

Cycle	A "*" shows what steps are in each cycle						Cycle Time (Minutes)
	Wash	Rinse	Main Wash	Rinse	Rinse	Dry	
<b>Pots &amp; Pans</b> A double wash for maximum cleaning of cooked-on or baked-on foods.  <b>NOTE: The cycle pauses to heat water to 135°F (57°C) in both washes (marked ††) and in the final rinse (marked †). See page 13.</b>	•††	•	•††	•	•†	•	76*
<b>Heavy Wash</b> A double wash for cleaning heavily soiled loads.  <b>NOTE: The cycle pauses while the dishwasher heats water to 135°F (57°C) in the final rinse (marked †). If the Hi-Temp Wash option is selected water will also be heated in the main wash (marked ††). See page 13.</b>	•	•	•††	•	•†	•	76*
<b>Normal Wash</b> A double wash for normal, every-day soiled loads. (The Energy Guide Label is based on this cycle.)  <b>NOTE: The cycle pauses while the dishwasher heats water to 135°F (57°C) in the final rinse (marked †). If the Hi-Temp Wash option is selected water will also be heated in the main wash (marked ††). See page 13.</b>	•		•††	•	•†	•	66*

\*Cycle time includes heated dry time. Cycle time may vary depending on the temperature of the water entering the dishwasher.

continued on next page

## USING YOUR DISHWASHER

Cycle	A "*" shows what steps are in each cycle						Cycle Time (Minutes)
	Wash	Rinse	Main Wash	Rinse	Rinse	Dry	
<b>Low Energy</b> A single wash for pre-rinsed or lightly soiled loads.  <b>NOTE: The cycle pauses while the dishwasher heats water to 135°F (57°C) in the final rinse (marked †). If the Hi-Temp Wash option is selected water will also be heated in the main wash (marked ††). See page 13.</b>			††	•	•†	•	60*
<b>Rinse &amp; Hold</b> For rinsing a few items to be washed one or more days later. Do not use detergent.				•	•		12

\*Cycle time includes heated dry time. Cycle time may vary depending on the temperature of the water entering the dishwasher.

## What happens in each option

Options can be selected by pressing the OPTIONS pad. Each press of the pad advances the selection to the next option. You can select Heat Dry, Heat Dry and Hi-Temp, Air Dry, or Air Dry and Hi-Temp. For example, if the AIR DRY signal light is on and you want to select the Heat Dry option, press the OPTIONS pad twice.



### NOTE:

- All options can be changed any time during a cycle.
- The Hi-Temp option is preset for the Pots & Pans cycle, only Heat Dry or Air Dry options can be selected.
- If the Rinse & Hold cycle is selected, options are not available.

### Heat Dry option

When the Heat Dry option is selected, air in the dishwasher is heated during the “dry” part of the cycle. The HEAT DRY signal light will be on when this option is selected. For best drying results, use a liquid rinse agent.

**NOTE:** The Heat Dry option is not available during the Rinse & Hold cycle.

### Air Dry option

When the Air Dry option is selected, air in the dishwasher is not heated during the “dry” part of the cycle. The AIR DRY signal light will be on when this option is selected. The Air Dry option helps save energy, but the load takes longer to dry (overnight) and some spotting may result. Some items, (such as plastics) may need towel drying. For best drying results, use a liquid rinse agent.

### Hi-Temp option

When the Hi-Temp Wash option is selected, water is heated in the dishwasher during the main wash to improve washability. The Hi-Temp Wash option is automatically selected for both washes of the Pots & Pans cycle. See “Cycle selection chart” on pages 11 and 12.

#### NOTE:

- The HI-TEMP signal light will be on when this option is selected.
- The cycle will pause while the water is heating.
- When the water temperature reaches 135°F (57°C), the cycle will begin again.
- The heating time is based on the temperature of the water supply as it enters the dishwasher. The cooler the water, the longer the heating time.  
If water temperature at the faucet is below 120°F (49°C), have a qualified person raise the water heater’s thermostat setting. See page 17.
- The dishwasher does not pause to heat the water if the water entering the dishwasher is already 135°F (57°C).

A black rectangular button with a white square on the left and the text "HEAT DRY" on the right.A black rectangular button with a white square on the left and the text "AIR DRY" on the right.A black rectangular button with a white square on the left and the text "HI-TEMP" on the right.

## Using the detergent dispenser

### What type of detergent to use

- Use automatic dishwasher detergent only. Other detergents are too mild and much too sudsy to work in the dishwasher.
- Follow manufacturer's directions when using liquid automatic dishwasher detergent or concentrated powder detergent.
- Do not add detergent until you are ready to wash.
- Store detergent tightly closed in a cool, dry place. Fresh automatic dishwasher detergent is necessary for best washing results.

**NOTE:** Different brands of dishwasher detergent have different amounts of phosphorus for softening water. If water is hard and phosphorus content is low (6.0% or less), you may need to:

- Use more detergent.
- OR
- Use a brand with a higher phosphorus content (8.7%).

### The detergent dispenser

The detergent dispenser has one section with a cover and one without.

- Put detergent in both sections for cycles with two washes. See "Cycle selection chart" on pages 11 and 12.
- Put detergent only in the covered section for cycles with one wash. See "Cycle selection chart" on pages 11 and 12.
- Push the cover down until it is latched.

Detergent in the open section falls into the dishwasher when the door is closed. The covered section opens automatically when the main wash starts.

**NOTE:** It is normal for cover to open partially when dispensing detergent. The cover will open fully when the door is opened.

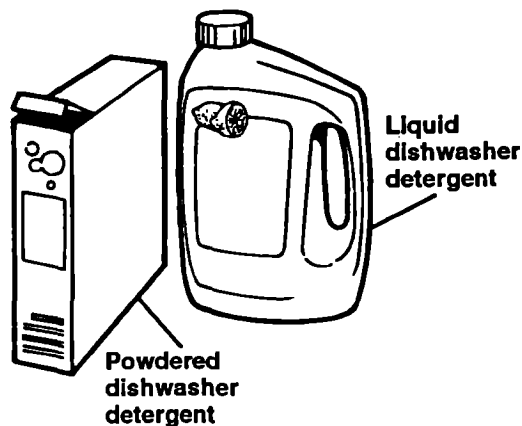

See phosphorus content on package labels

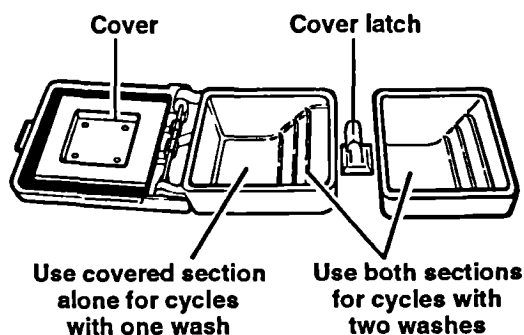

### How much detergent to use

The amount of detergent to use depends on the hardness of your water. If too little is used, dishes won't be clean. However, if too much is used in soft water, glassware will begin to etch.

- **HARD**—Fill one or both sections to the top of third step (3 tablespoons) if water hardness is 8 or more grains per gallon, or 136 or more parts per million.
- **MEDIUM**—Fill one or both sections to the top of the second step (2 tablespoons) if water hardness is 5 to 7 grains per gallon, or 85 to 119 parts per million.
- **SOFT**—Fill one or both sections to the top of the first step (1 tablespoon) if water hardness is 0 to 4 grains per gallon, or 0 to 68 parts per million.

Find out your water's hardness by asking your local water department, water softener company or county extension agent.

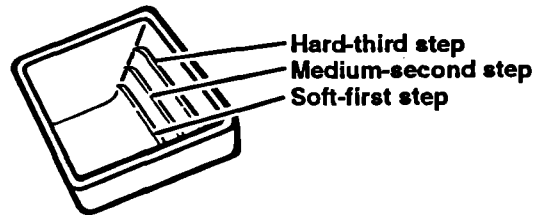

---

## Using the rinse agent dispenser

### Rinse agent dispenser

Keep the rinse agent dispenser filled with a liquid rinse agent. A rinse agent greatly improves the drying of dishes by helping water flow off them during the last rinse. A rinse agent also keeps water from forming droplets and drying as spots.

Release of a small amount of rinse agent into the rinse water is automatic in the final rinse of each cycle. For best drying results, check the dispenser periodically to see if it needs refilling.

### To check dispenser

Remove dispenser cap. If dispenser is empty, an "E" will be clearly visible inside the dispenser.

"E" shows  
when empty



### On some models:

The center of the Fill Indicator Cap will be clear when dispenser needs refilling.

Center will be  
clear when  
empty, on some  
models

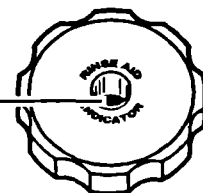

## USING YOUR DISHWASHER

### On some models:

1. Press the flexible clear top of the Fill Indicator Cap to draw rinse agent into cap.

**NOTE:** You may need to press cap two or three times to remove all of the air bubbles from the cap.

2. When rinse agent does not show in cap, even after pressing flexible cap several times, dispenser needs refilling.

### To fill dispenser

You do not have to wait until the dispenser is empty to refill it, but do not overfill it. The dispenser will hold 6 ounces (175 mL) of rinse agent. Under normal conditions, this will last about 3 months.

1. Make sure the dishwasher door is fully open.
2. Remove the Fill Indicator Cap.
3. Add rinse agent to the dispenser. Do not fill past the smallest opening in the lower part of the dispenser.

If you overfill, excess rinse agent can come out. This will not harm the dishwasher, but could cause over-sudsing.

4. Clean up any spilled rinse agent with a damp cloth.
5. Replace the Fill Indicator Cap and keep it tightly closed.

**NOTE:** Your dishwasher is designed to use a liquid rinse agent. You do not need to use a solid or bar-type rinse agent.

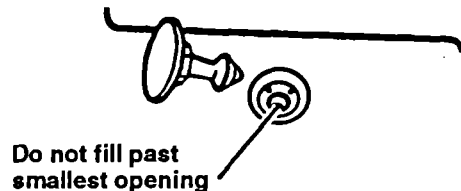
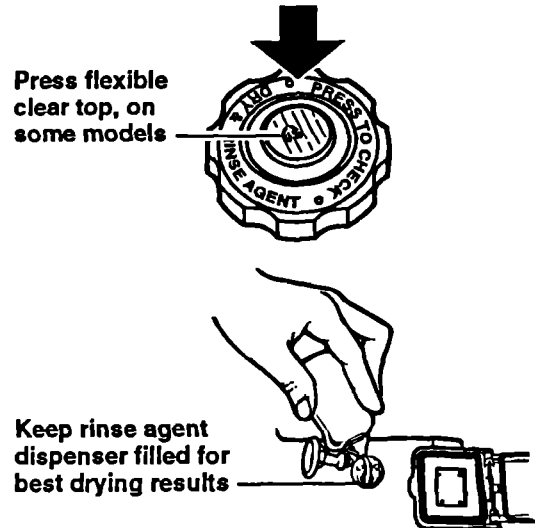

## Quiet operating tips

To avoid thumping and clattering noises during operation:

- Make sure lightweight load items are secured in the racks.
- Make sure pot lids and handles, pizza pans, cookie sheets, etc. do not touch interior walls or interfere with the spray arm's rotation or cover the spray tower.

- Load dishes so they do not touch one another.

**NOTE:** Keep sink drain plugs inserted during dishwasher operation to prevent noise transfer through drains.

---

### Water temperature tips

Hot water dissolves and activates the dishwashing detergent. Hot water also dissolves grease on dishes and helps dry glasses spot-free. Use the Hi-Temp option if you keep your water heater at a low setting.

For best dishwashing results, water must be at least 120°F (49°C) as it enters the dishwasher.

#### To check water temperature

1. Run hot water at the faucet closest to your dishwasher. Let the water run for at least one minute.
2. Measure the water temperature with a candy or meat thermometer. Put the thermometer in the running stream of water.
3. If the water temperature at the faucet is below 120°F (49°C), have a qualified person raise the water heater's thermostat setting.

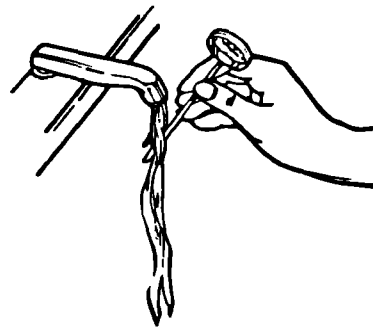

---

### Energy saving tips

You can help save energy if you:

- Wash full loads. Running a half-filled dishwasher uses the same amount of electricity and hot water as a fully loaded machine.
  - Use the Low Energy Cycle whenever possible. The cycle uses less hot water and energy than the Normal cycle.
  - Use the Air Dry option when you don't need a rapid drying cycle. Allow longer drying times (overnight). Use a rinse agent to improve drying.
  - Do not use the Hi-Temp Wash option. When this option is off, the dishwasher will not pause to heat water to 135°F (57°C) during the main wash.
  - Use the delay feature to run your dishwasher during off-peak hours. Local utilities recommend this to avoid heavy usage of energy at certain times of day.
- NOTE:** Loads may not wash as well if the water temperature is too low.

## USING YOUR DISHWASHER

### Special tips on dishwasher use

If you have any doubts about washing a particular piece of dishware, check with the manufacturer to see if it is dishwasher safe.

**NOTE:** It is the user's responsibility to determine if dishware should be washed in a dishwasher.

Material	Dishwasher Safe?	Exceptions/Special Information
Aluminum	Yes	High water temperature and detergents may affect finish of anodized aluminum.
Cast Iron	No	Seasoning will be removed and iron will rust.
China/ Stoneware	Yes	Always check manufacturer's recommendations before washing. Antique, hand-painted or over-the-glaze patterns may fade. Gold leaf may discolor or fade.
Crystal	Yes	Always check manufacturer's recommendations before washing. Some types of leaded crystal may etch with repeated washings.
Gold	No	Gold-colored flatware will discolor.
Glass	Yes	Milk glass will yellow with repeated dishwasher washing.
Hollow- Handle Knives	No	Handles of some knives are attached to the blade with adhesives which may loosen if washed in the dishwasher.
Pewter	No	High water temperatures and detergent may discolor or pit finish.
Disposable Plastics	No	Cannot withstand high water temperatures and detergents.
Plastics	Yes	Always check manufacturer's recommendations before washing. Plastics vary in their capacity to withstand high water temperatures and detergents.
Stainless Steel	Yes	Run a Rinse & Hold cycle if not washing immediately. Prolonged contact with food containing salt, vinegar, milk products or fruit juice could damage finish.
Sterling Silver or Silver plate	Yes	Run a Rinse Hold cycle if not washing immediately. Prolonged contact with food containing salt, acid or sulfide (eggs, mayonnaise and seafood) could damage finish.
Tin	No	May rust.
Wooden Ware	No	Always check manufacturer's recommendations before washing. Untreated wood may warp, crack or lose its finish.
Bottles and Cans	No	Labels attached with glue can loosen during a wash. Loose labels can clog spray arms or the pump and will reduce washing performance. Remove labels before putting items in dishwasher or wash by hand.

# Loading Your Dishwasher

## In This Section

	Page	Page
Preparing to load the dishwasher ...	19	Loading the silverware basket .....21
Loading the top rack .....	19	Loading the cutlery basket .....22
Loading the bottom rack.....	20	

This section tells you how to properly load your dishwasher for the best washing and rinsing results.

## Preparing to load the dishwasher

- To save water and energy, do not rinse dishes before putting them into the dishwasher.
- Remove large pieces of food, bones and other hard items. The POWER CLEAN™ module will remove food particles from the water. The module contains a chopping device which will reduce the size of food items.
 

**NOTE:** If hard items such as fruit seeds, nuts and egg shells enter the POWER CLEAN module, you might hear chopping, grinding, crunching or buzzing sounds. Those sounds are normal when hard items enter the module. Do not let metallic items (such as pot handle screws) get into the POWER CLEAN module. This could damage the POWER CLEAN module.
- Foods like eggs, rice, pasta, and cooked cereals may be hard to remove if they are left to dry over a period of time. Run a Rinse & Hold cycle to keep dishes moist if you do not plan to wash them soon.
- Load dishes so soiled surfaces face the rotating spray arms.
- Load dishes so they are not stacked or overlapping. It is important for the water spray to reach all soiled surfaces for best washing. For best drying, water must be able to drain from all surfaces.

## Loading the top rack

The top rack is designed for cups, glasses and smaller items. Do not cover the third level wash when loading the top rack.

### Cup and glass load

- Place so open ends face down for cleaning and draining.
- Load glasses in top rack only—bottom rack is not designed for glasses. Damage may occur.
- Place items in the rows between prongs. Placing them over the prongs can lead to breakage.
- Be sure lightweight items are held firmly in place.
- China, crystal and other delicate items must not touch each other during dishwasher operation. Damage may occur.

Do not cover third level wash

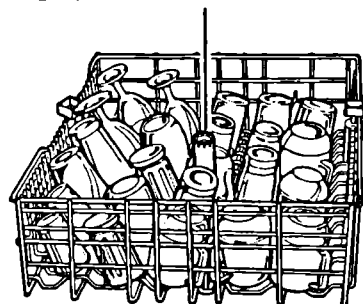

Cup and glass load

## LOADING YOUR DISHWASHER

### Mixed load

- Load plastic items in the top rack only. Only plastic items marked "dishwasher safe" are recommended.
- Load plastic items so the force of the spray does not move them during the cycle.
- Plastic items can be melted in the bottom rack.

### Utensil load

- Small bowls, pans and other utensils can be placed in the top rack.

### Extra-capacity fold down shelves (on some models)

Extra shelves on both sides of the top rack can be folded down over short items (cups, juice glasses, cereal bowls, etc.) to hold extra items.

- Adjust rack height if necessary (see below).
- To avoid chipping, do not let stemware touch other items.

### Infinite adjustable top rack

You can raise or lower the rack to fit tall items in either the top or bottom rack. The top rack does not have to be level.

- Turn the knob clockwise to raise a side of the rack.
- Turn the knob counterclockwise to lower a side of the rack.

Do not cover third level wash

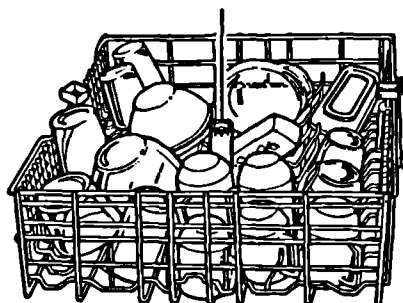

Mixed load

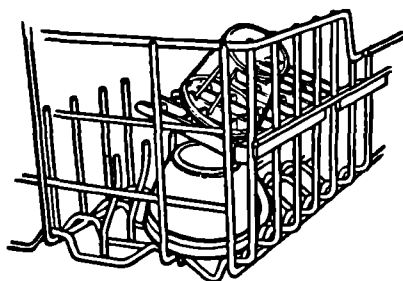

Raise

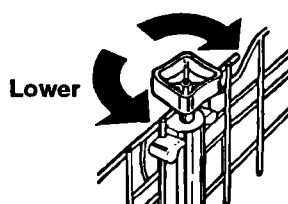

Lower

## Loading the bottom rack

Items with cooked-on or dried-on food should be loaded in the bottom rack, with soiled surfaces facing inward to the spray.

### Mixed load

- Make sure pot handles and other items do not stop rotation of the lower spray arm. Spray arm must move freely.
- Load items so they do not block or cover the spray tower.
- Securely place heavily soiled cookware face down in rack.

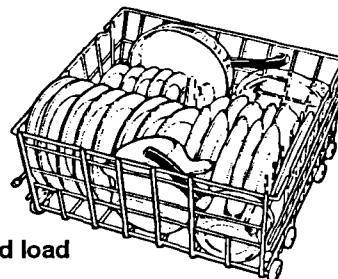

Mixed load

## LOADING YOUR DISHWASHER

### Dish load

- Place plates, soup bowls, etc., between prongs and facing inward to the spray.
- Do not place items directly over spray tower.

### Utensil load

- Load cookie sheets, cake pans and other large items at sides and back. Loading such items in front may keep water spray from reaching detergent dispenser and silverware basket.

#### NOTE:

- Do not load glasses, cups or plastic items in the bottom rack.
- When lower rack is removed, replace with bumpers in front.

### Fold down divider (on some models)

A fold down divider at the back of the rack can be lowered to make room for deep bowls, roasters, etc.

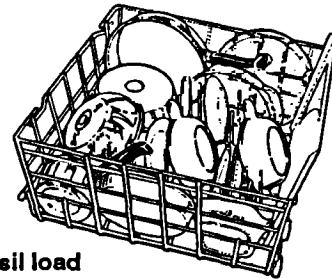

Utensil load

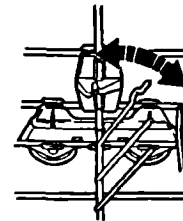

## Loading the silverware basket

### ⚠ WARNING

#### Personal Injury Hazard

Load sharp items (knives, forks, skewers, etc.), with the point down. Failure to do so could cause personal injury.

- Load the silverware basket while it is in the door or take the basket out for loading on a counter or table.

**NOTE:** The basket can also be removed for easy unloading. Always unload or remove the basket before unloading the racks to avoid spilling water droplets on the silverware.

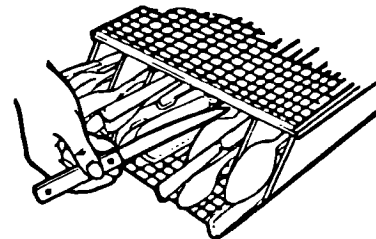

## LOADING YOUR DISHWASHER

- Load forks and spoons so they don't nest together. Spray cannot reach nested items.
- Mix items in each section of the basket with some pointing up and some down.
- Small items (baby bottle caps, jar lids, etc.) can be put in any section.

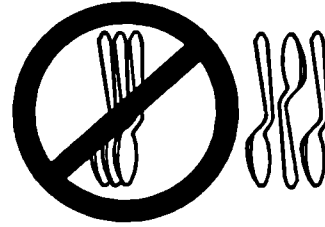

### To remove the basket

1. Grab the basket by the handle and slide it toward the top of the door.
2. Lift the basket off the holding buttons.

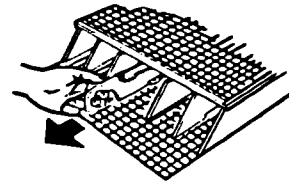

### To replace the basket

1. Set the basket on the holding buttons.
2. Slide the basket toward the bottom of the door until it locks in place.

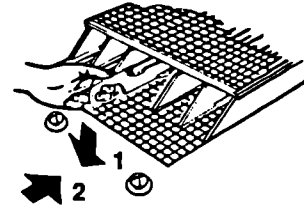

### To open the basket

Unhook the latch as shown.

**NOTE:** Be sure the cover is completely latched before pulling out the bottom rack and before closing the dishwasher door.

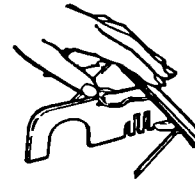

---

## Loading the cutlery basket

(on some models)

Remove and replace the cutlery basket in the same way as the silverware basket. Use the cutlery basket for long items. Remove the basket and tip contents onto a cutting board to unload. This can help avoid accidents with sharp points and edges.

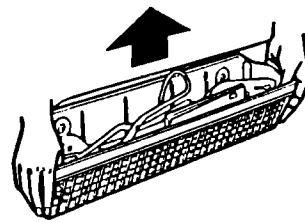

# Caring For Your Dishwasher

Your new dishwasher is designed to give you many years of dependable service. There are a few things you can do to maintain your dishwasher properly. This section tells you how to clean and care for your dishwasher. Refer to "Solution chart" on pages 24-26 for special cleaning problems.

## **⚠ WARNING**

### **Personal Injury Hazard**

Before cleaning interior or filter screen, wait at least 20 minutes after a cycle for the heating element to cool down.

Failure to do so can result in burn injuries.

---

## **Cleaning the exterior**

In most cases, regular use of a soft, damp cloth or sponge and a mild detergent is all that is necessary to keep the outside of your dishwasher nice looking and clean.

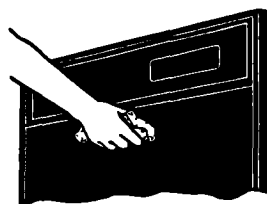

---

## **Cleaning the interior**

Hard water minerals may cause a white film to build up on the inside surfaces, especially just beneath the door area. To clean interior:

- Apply powdered dishwasher detergent to a damp sponge to make a paste.

OR

- Use liquid automatic dishwasher detergent and clean with damp sponge.

Wear rubber gloves. **Do not** use any type of cleanser other than dishwasher detergent because it may cause foaming or sudsing.

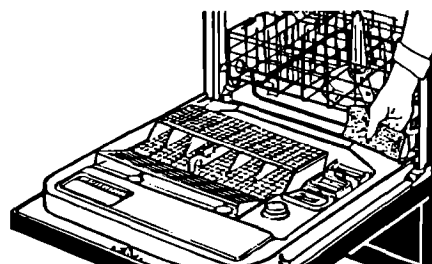

# Common Dishwashing Problems

<b>In This Section</b>	<b>Page</b>	<b>Page</b>
Solution chart .....	24	Removing spots and film .....26

## Solution chart

A convenient checklist for handling minor performance problems. Go over this list before calling for service. If you are unable to solve your dishwasher's problem, turn to page 27 for service information.

<b>Problem</b>	<b>Cause</b>	<b>Solution</b>
Food Soil Left on Dishes	Improper loading	Follow loading instructions on pages 19-22.
	Water temperature is too low	Use the Hi-Temp option. If needed, turn home water heater up to ensure water entering dishwasher is 120°F (49°C) minimum. See recommended procedure on page 17.
	Use of incorrect, too little or ineffective detergent	Use recommended dishwasher detergents only. Follow recommendations on pages 14 and 15 for amounts; never use less than one tablespoon per load. Detergent must be fresh to be effective. Always store detergent in a cool, dry area, preferably in an airtight container.
	Detergent cakes in dispenser	Use fresh detergent only. Do not allow detergent to sit for several hours in a wet dispenser. Check dispenser for caked detergent. Clean dispenser when caked detergent is present.
	Pump or spray arm clogged by labels from bottles and cans	Remove labels before washing or wash by hand. See page 18.
	Low water pressure due to insufficient fill	Home water pressure should be 20 to 120 psi for proper dishwasher fill. A booster pump on the water supply may be necessary if pressure is too low.
	Slowdown of wash arm due to high suds	Never use soap or laundry detergents. Use recommended dishwasher detergents only.
Spotting and Filming	Hard water or high mineral content in water	Conditioning the final rinse water with a liquid rinse agent helps eliminate spotting and filming. Keep the dispenser full with a rinse agent at all times.

## COMMON DISHWASHING PROBLEMS

Problem	Cause	Solution
Spotting and Filming (continued)	<p>Water temperature is too low</p> <p>Use of incorrect detergents</p> <p>Incorrect amount of detergent</p> <p>Use of ineffective detergents</p> <p>Insufficient fill caused by low water pressure</p>	<p>Use the Hi-Temp option. If needed, turn home water heater up to ensure water entering dishwasher is 120°F (49°C) minimum. See recommended procedure on page 17.</p> <p>Use recommended dishwasher detergents only.</p> <p>Follow recommendations on pages 14 and 15 for amount. Heavy soil and/or hard water generally require extra detergent.</p> <p>Detergent should be fresh. Store in a cool, dry place, preferably in an airtight container. Discard lumpy detergent.</p> <p>Home water pressure should be 20 to 120 psi for proper dishwasher fill. A booster pump on the water supply may be necessary if pressure is too low.</p>
Cycle Takes Extremely Long Time	Water temperature is too low	If needed, turn home water heater up to ensure water entering dishwasher is 120°F (49°C) minimum. See recommended procedure on page 17.
Dishes Do Not Dry Completely	<p>Dishes do not drain properly</p> <p>Plastics</p>	<p>Dishes must have proper water drainage. Do not overload. Follow instructions for loading dishwasher on pages 19-22. Use a liquid rinse agent to speed draining.</p> <p>Some plastics, due to material, may need to be towel dried.</p>
Silica Film or Etching (Silica Film is a White Iridescent Deposit; Etching is a Cloudy Film)	A water chemical reaction with certain types of glassware. Usually caused by some combination of soft or softened water, alkaline washing solutions, insufficient rinsing, over-loading the dishwasher, and heat of drying.	It may not be possible to prevent problem, except by hand-washing. To retard this process, use a minimum amount of detergent but not less than one tablespoon per load. Use a liquid rinse agent and underload the dishwasher to allow thorough rinsing. Silica film and etching are permanent and can not be removed. Use the Air Dry option.
Black or Gray Marks on Dishes	Aluminum items	Aluminum items should be loaded so that they will not rub against dishes during washing. Throw-away aluminum items should not be washed in the dishwasher because they may break down and cause marking. Aluminum markings can be removed by using a mild abrasive cleanser.

continued on next page

## COMMON DISHWASHING PROBLEMS

Problem	Cause	Solution
Brown Stains on Dishes and Dishwasher Interior	High iron content in water supply	Remove by washing dishes (after food soil has been removed) with 1 teaspoon to 1 tablespoon of citric acid crystals added to covered section of detergent dispenser. Do not use detergent. Follow with a Low Energy cycle with detergent. If treatment is needed more often than every other month, the installation of an iron removal unit is recommended.
Orange Stains on Dishwasher Interior	Large amounts of tomato based foods on dishes placed in the dishwasher	Stains may gradually fade over time. Regular use of Heat Dry option may cause stains to fade slower. Stains will not affect dishwasher performance. Regular use of Rinse & Hold cycle with Air Dry option for partial loads will reduce the likelihood of staining.
White Spots on Cookware with Non-Stick Finish	Seasoning removed by dishwasher detergents	Re-season cookware after dishwasher washing.
Odor in the Dishwasher	Dishes only washed every two to three days	Run a Rinse & Hold cycle at least once or twice a day until a full load is accumulated.
Chipping of Dishes	Improper loading	Load dishes and glasses so that they are stable and do not strike together from washing action. Moving racks in and out smoothly will also minimize chipping.  <b>NOTE:</b> Some types of china and glassware are too delicate for automatic dishwashing and should be hand-washed; for example: antiques, feather-edged crystal and similar types.

## Removing spots and film

Keep the rinse agent dispenser filled with a liquid rinse agent. A rinse agent prevents water from forming droplets and drying as spots or streaks.

To remove spots and film on dishes and glasses, or hard water film on the interior of the dishwasher, you may use white vinegar with the following procedure:

1. Load clean dishes and glasses in dishwasher in regular manner. Do not load silverware or other metals in the dishwasher.
2. Close and latch door.
3. Select the Heavy cycle and Air Dry option. Do not use detergent.
4. Allow dishwasher to run through the first wash. When washer has filled for main wash portion of cycle, unlatch and open door.
5. Pour 2 cups of household vinegar into the dishwasher.
6. Close and latch door. Allow dishwasher to finish the cycle.

# If You Need Assistance Or Service

This section is designed to help you save the cost of a service call. When calling our Consumer Assistance Center for help or calling for service, please provide a detailed description of the problem, your appliance's complete model and serial numbers and the purchase date. (See page 2.) This information will help us respond properly to your request.

## 1. Before calling for assistance ...

Please check the chart below for problems you can fix. It could save you the cost of a service call.

<b>PROBLEM</b>	<b>CHECK THE FOLLOWING</b>
<b>Dishwasher does not run or stops during a cycle</b>	<p>Is the door tightly closed and securely latched?</p> <p>Has the cycle been set correctly? See page 6.</p> <p>Has a household fuse or circuit breaker blown or tripped?</p> <p>Is the delay feature on?</p> <p>If the motor has stopped because of an overload, it will automatically reset itself within a few minutes. If the motor does not start, call for service.</p> <p>Is the water supply turned on?</p> <p>Is the dishwasher wired into a live circuit with the proper voltage?</p>
<b>Dishwasher seems to run too long</b>	The dishwasher will run longer while heating the water. This is normal for lower incoming water temperatures. See page 13.
<b>Dishwasher will not fill</b>	Is overflow protector stuck in "up" position? Overflow protector should move up and down freely. Press down to release.
<b>Water remains in dishwasher</b>	<p>Wait for the cycle to finish. A small amount of water remaining is normal.</p> <p>Check the drain air gap (if installed). If it is clogged follow the manufacturer's cleaning instruction.</p>
<b>Detergent remains in covered section of dispenser</b>	<p>Has the cycle completed?</p> <p>Is the detergent fresh and dry without lumps?</p> <p>Is the bottom rack in backwards? The rack bumpers should face the door.</p>
<b>Dishes are not as dry as you expected</b>	<p>Is the rinse agent dispenser empty? Using a rinse agent greatly improves drying. See page 12.</p> <p>Do not use Air Dry option on the next load. See page 13.</p>
<b>Grinding, grating, crunching or buzzing sounds</b>	<p>Has a hard object entered the POWER CLEAN™ module?</p> <p>The sound should stop when the object is ground up.</p>

continued on next page

## IF YOU NEED ASSISTANCE OR SERVICE

PROBLEM	CHECK THE FOLLOWING
<b>White residue appears on front of access panel</b>	<p>Is too much detergent being used? See pages 14 and 15 for recommended amounts of detergent.</p> <p>Some liquid detergents develop excess foam and build up on access panel. Try a different brand to reduce foaming and eliminate build-up.</p>
<b>WATER HEATING signal light flashes</b>	Is the water supply less than 120°F (49°C) when it enters the dishwasher? See pages 10 and 17.
<b>Control panel does not work</b>	<p>Is the door open?</p> <p>Is the cycle pause feature on? See page 7.</p> <p>Is the control panel lock-out feature on? See page 9.</p>
<b>All signal lights flash and the dishwasher stops or will not run</b>	Has there been a power failure? See page 11.
<b>Control panel does not “beep” when pads are pressed</b>	Is the control panel lock-out feature on? See page 9.
<b>Dishwasher drains after turning off CLEAN signal light and/or closing the door</b>	Did you accidentally press the CANCEL/DRAIN pad while closing the door? Press CANCEL/DRAIN pad again to stop draining. Restart cycle if needed.

**2. If you need assistance\* ...**

Call Whirlpool Consumer Assistance Center telephone number. Dial toll-free from anywhere in the U.S.A.:

**1-800-253-1301**

and talk with one of our trained consultants. The consultant can instruct you in how to obtain satisfactory operation from your appliance or, if service is necessary, recommend a qualified service company in your area.

If you prefer, write to:

Mr. William Clark  
Consumer Assistance Representative  
Whirlpool Corporation  
2000 M-63  
Benton Harbor, MI 49022

Please include a daytime phone number in your correspondence.

**3. If you need service\* ...**



Whirlpool has a nationwide network of authorized Whirlpool® service companies. Whirlpool

service technicians are trained to fulfill the product warranty and provide after-warranty service anywhere in the United States. To locate the authorized Whirlpool service company in your area, call our Consumer Assistance Center telephone number (see Step 2) or look in your telephone directory Yellow Pages under:

**• APPLIANCE-HOUSEHOLD-MAJOR, SERVICE & REPAIR**

- See: Whirlpool Appliances or Authorized Whirlpool Service (Example: XYZ Service Co.)

**• WASHING MACHINES & DRYERS, SERVICE & REPAIR**

- See: Whirlpool Appliances or Authorized Whirlpool Service (Example: XYZ Service Co.)

**4. If you need FSP® replacement parts ...**

FSP is a registered trademark of Whirlpool Corporation for quality parts. Look for this symbol of quality whenever you need a replacement part for your Whirlpool® appliance. FSP replacement parts will fit right and work right, because they are made to the same exacting specifications used to build every new Whirlpool appliance.

To locate FSP replacement parts in your area, refer to Step 3 above or call the Whirlpool Consumer Assistance Center number in Step 2.

**5. If you are not satisfied with how the problem was solved ...**

- Contact the Major Appliance Consumer Action Panel (MACAP). MACAP is a group of independent consumer experts that voices consumer views at the highest levels of the major appliance industry.
- Contact MACAP only when the dealer, authorized servicer and Whirlpool have failed to resolve your problem.

Major Appliance Consumer Action Panel  
20 North Wacker Drive  
Chicago, IL 60606

- MACAP will in turn inform us of your action.

**\*When calling or writing for help or service:**

Please provide a detailed description of the problem, your appliance's complete model and serial numbers and the purchase date. (See page 2.) This information will help us respond properly to your request.

**POWER CLEAN™ washing system parts covered by your warranty**

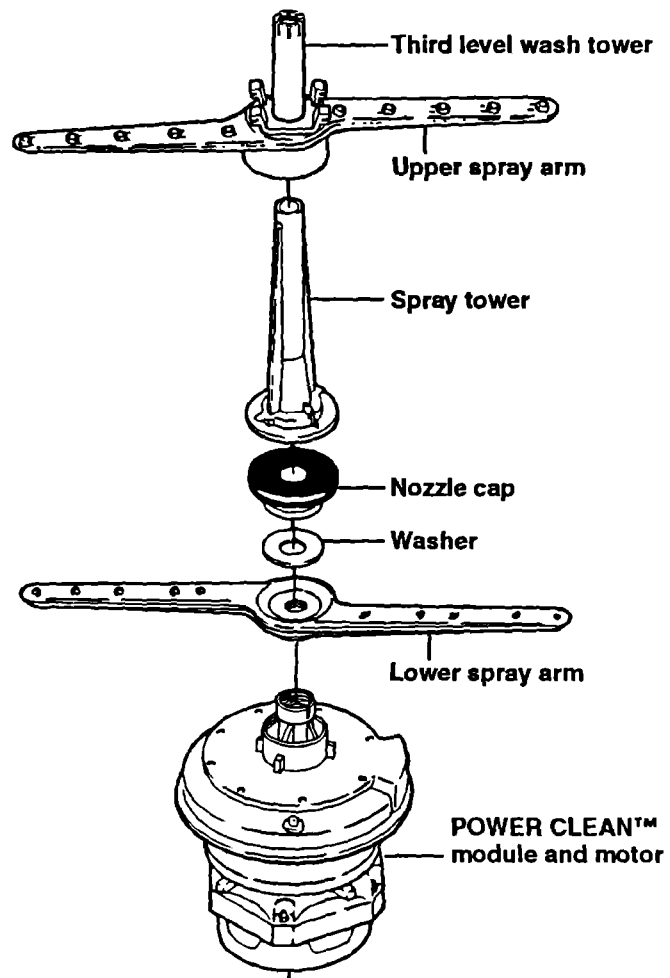

# WHIRLPOOL® Dishwasher Warranty

LENGTH OF WARRANTY	WHIRLPOOL WILL PAY FOR
<b>FULL ONE-YEAR WARRANTY</b> From Date of Purchase	FSP® replacement parts and repair labor to correct defects in materials or workmanship. Service must be provided by an authorized Whirlpool® service company.
<b>LIMITED ONE-YEAR WARRANTY</b> Second Year From Date of Purchase	FSP replacement parts for any part of the POWER CLEAN™ Washing System if defective in materials or workmanship. These parts are shown on page 31 of this book.
<b>LIMITED FOUR-YEAR WARRANTY</b> Second Through Fifth Year From Date of Purchase	FSP replacement parts for Electronic Control System if defective in materials or workmanship.  For models with platinum nylon coated dishracks, FSP replacement parts for the upper and/or lower dishracks if they rust due to defective materials or workmanship.
<b>FULL TWENTY-YEAR WARRANTY</b> From Date of Purchase	FSP replacement parts and repair labor for the DURAPERM™ tub and/or inner door should they fail to contain water due to defective materials or workmanship. Service must be provided by an authorized Whirlpool service company.
<b>WHIRLPOOL WILL NOT PAY FOR</b>	
<p><b>A. Service calls to:</b></p> <ol style="list-style-type: none"> <li>1. Correct the installation of the dishwasher.</li> <li>2. Instruct you how to use the dishwasher.</li> <li>3. Replace house fuses or correct house wiring or plumbing.</li> </ol> <p><b>B. Repairs when dishwasher is used in other than normal, single-family household use.</b></p> <p><b>C. Pickup and delivery.</b> This product is designed to be repaired in the home.</p> <p><b>D. Damage to dishwasher caused by accident, misuse, fire, flood, acts of God or use of products not approved by Whirlpool.</b></p> <p><b>E. Any labor costs during limited warranties.</b></p> <p><b>F. Repairs to parts or systems caused by unauthorized modifications made to the appliance.</b></p>	

7/93

WHIRLPOOL CORPORATION SHALL NOT BE LIABLE FOR INCIDENTAL OR CONSEQUENTIAL DAMAGES. Some states do not allow the exclusion or limitation of incidental or consequential damages, so this limitation or exclusion may not apply to you. This warranty gives you specific legal rights, and you may also have other rights which vary from state to state.

Outside the United States, a different warranty may apply. For details, please contact your authorized Whirlpool distributor or military exchange.

If you need service, first see the "Assistance or Service" section of this book. After checking "Assistance or Service," additional help can be found by calling our Consumer Assistance Center telephone number, 1-800-253-1301, from anywhere in the U.S.A.



Printed on recycled paper—  
10% post consumer waste  
50% recovered materials

**PART NO. 3373743**

© 1993 Whirlpool Corporation

® Registered Trademark / TM Trademark of Whirlpool Corporation.

Printed in U.S.A.