

This Owner's Manual is provided and hosted by [Appliance Factory Parts](#).



LENNOX HEARTH LBC-4324 Owner's Manual

[Shop genuine replacement parts for LENNOX HEARTH
LBC-4324](#)



[Find Your LENNOX HEARTH Fireplace Parts - Select From 237 Models](#)

----- Manual continues below -----



HEARTH PRODUCTS

HOMEOWNER'S CARE AND OPERATION INSTRUCTIONS

ELITE SERIES

38" & 43" Wood Burning Fireplaces
P/N 875,003M REV. B 08/2005

MODELS

<i>LBR-3824</i>	<i>LBC-3824</i>
<i>LBR-3824-H</i>	<i>LBC-3824-H</i>
<i>LBR-4324</i>	<i>LBC-4324</i>
<i>LBR-4324-H</i>	<i>LBC-4324-H</i>

The information contained in this manual applies to all model fireplaces identified on this page. This information will help you obtain safe and dependable service from your Lennox fireplace system. Keep this document in a safe place for future reference.

Before you start your first fire, read this Care and Operations Manual carefully to be sure you understand your fireplace system completely. Failure to follow these suggestions could result in hazardous operation or fireplace malfunction, creating a serious potential for personal injury and/or property damage.

If you have any questions regarding the safe use or operation of your fireplace, contact your local Lennox Dealer or your contractor/builder.

**RETAIN THESE INSTRUCTIONS
FOR FUTURE REFERENCE**



WH Report No. 629-915173A

TABLE OF CONTENTS

General Safety Precautions	page 2
General Information	page 2
Fuels	page 2
Gas Logs	page 2
Disposal of Ashes	page 3
Softwood vs Hardwood	page 3
Starting a Fire	page 4
Damper Control	page 4
Glass Door Operating Safety	
Precautions and Instructions	page 4
Combustion Air	page 5
Refractories	page 5
Maintenance Guidelines	page 6
Twice a Year Check-Up	page 6
Creosote Formation and Removal	page 6
Troubleshooting	page 6
Warranty	page 7
Product Reference Information	page 7
Replacement Parts	page 7
Accessory Components	page 7
Replacement Parts List	page 8

GENERAL SAFETY PRECAUTIONS IMPORTANT! READ AND UNDER- STAND BEFORE YOUR FIRST FIRE.

1. Use SOLID WOOD only for fuel. It is best to use dry and well seasoned hardwood. Soft woods tend to burn very quickly. Solid scrap construction lumber produces excessive sparks. DO NOT use treated wood, artificial wax based logs, charcoal, coal, trash, driftwood or woods that have been dipped in tar, pitch, pine tar, creosote, etc. Wood products made with synthetic binders, such as plywood, produce abnormally high temperatures and sputtering, smoking fires.
2. NEVER use gasoline, gasoline-type lantern fuel, kerosene, charcoal lighter fluid, or similar liquids to start or "freshen up" a fire in this fireplace. Keep any flammable liquids a safe distance from the fireplace.
3. Keep the chimney damper open while any fire or smoldering embers are present .
4. Never block or restrict the room air intake grille across the bottom front or the warm air outlet grille across the top front of the fireplace.
5. Use care when selecting window treatments for windows located near the fireplace. Avoid using combustible flowing window treatments such as curtains on nearby windows that are of sufficient length to be blown in front of an open flame when the window is opened.

6. With the fire burning, close the protective mesh screens to keep sparks and embers INSIDE the firebox.

7. Keep any combustible furniture or decorative pillows at least 36" (914 mm) from the fireplace opening.

8. Never leave your fireplace unattended while it is burning.

9. Be careful adding wood fuel to the fire or handling fireplace tools such as shovels, tongs or pokers.

10. Never modify or alter your fireplace system in any way. To do so may create a potential fire hazard and void the Limited Warranty.

11. The bottom refractory can be cracked by excessive abuse such as tossing heavy logs onto the grate or gouging with fireplace tools. Exercise caution when adding wood to your fireplace.

12. DO NOT use a fireplace insert or any other product not specified by the manufacturer for use with this fireplace.

13. If you are using your fireplace as a "decorative appliance," such as with a permanently installed gas log set, the fireplace damper must be permanently fixed in the open position. Listed "vent-free" gas log sets may be used with the damper closed.

14. Always ensure that an adequate supply of replacement combustion air from the outside of the house is accessible to the fire to support normal combustion. Fireplaces consume large volumes of air during the normal combustion process. In the event the home is tightly sealed with modern energy efficient features, the optional combustion air kit may not provide all the air required to support combustion. Neither the manufacturer nor the seller are responsible for any smoking or related problems that may result from the lack of adequate combustion air. It is the responsibility of the builder/contractor to ensure that adequate combustion air has been provided for the fireplace.

15. Neither the manufacturer nor the seller warrants "smoke free" operation nor are they responsible for inadequate system draft caused by mechanical systems, general construction conditions, inadequate chimney heights, adverse wind conditions and/or unusual environmental factors or conditions beyond our control.

GENERAL INFORMATION

1. The all-steel, multi-wall firebox is the heat center of the system. It is well insulated for safe clearance to combustibles.

2. The hearth floor and sidewalls of the firebox are lined with a brick pattern reinforced refractory for the look of authenticity and to provide safety.

3. The metal chimney sections extending from the firebox top to beyond your roof are two walled and air-cooled. The inner passage, or flue, provides the exit for smoke and gases.

4. The flue damper is a two position (fully open or fully closed) mechanism operated by a handle found at the center top of the fireplace opening. It must be open when fire is present so smoke and gases can escape. It should be closed ONLY when the fire is completely out – keeping room air from being lost up the flue.

5. Closed screens prevent fire, sparks and embers from popping out of the firebox while a fire is burning. Pull screens back when adding wood to the firebox.

6. Why use a fuel grate? Besides positioning the firebed properly, it protects the refractory floor, back and sides of the fireplace. Further, it ensures a proper flow of combustion air into and around the firebed. The grate must be used at all times when burning. Your warranty may be voided without the use of this grate.

7. Remember, your fireplace is not intended to heat your entire home.

FUELS

Never Use Coal in Your Fireplace

Your fireplace system is not designed to be used with coal derivative products. The combustion process of certain types of coal can deposit corrosive materials in the fireplace and chimney system which can lead to premature product failure. Never use coal as a fuel in this fireplace system.

Gas Logs

If your fireplace system was installed with a gas line, you may wish to install one of two types of gas log sets.

This fireplace has been tested and approved for use with a decorative gas appliance incorporating an automatic shut-off device and complying with the Standard for Decorative Gas Appliances for installation in vented fireplaces, ANSI Z21.60 (1991). Decorative gas appliances may be installed in these fireplaces. Installation must be in accordance with the national Fuel Gas Code, ANSI Z223.1 for compliance with the revised U.L. 127 Standard.

CAUTION: WHEN USING A DECORATIVE GAS APPLIANCE, THE FIREPLACE DAMPER MUST BE SET TO THE FULLY OPEN POSITION.

These fireplaces have been tested and approved to ANSI/IAS/AGA Z21.11.2 for use with an unvented gas appliance having a maximum rating of 40,000 BTU and complies with the Standard for Factory-Built Fireplaces, U.L. 127, when installed with unvented gas log sets.

Prior to installing any gas log set, (Vented or Unvented) refer to the fireplace installation instructions for verification of mantle heights and placement of combustible materials around the firebox opening. **NEVER INSTALL AN UNVENTED GAS LOG SET WITH A BTU RATING GREATER THAN 40,000 BTU.** Vented gas log sets do not have restrictions placed upon their BTU rating.

Wood Fuel Pointers

Wood is a wonderful renewable fuel source. Normally it burns clean, leaving only a minimum of waste ash, provides comforting heat and can provide a variety of aromas and visual images.

You will want to know which woods are best for use. Sometimes you may want a quick, short fire to offset a morning chill. Soft woods are preferable in this case. Other times you would want more slow burning and a uniform heat output. Hardwoods are preferable for this use.

The amount of heat available from the logs will be about equal on a weight basis. However, logs are generally not weighed so the amount of heat will depend on:

1. The type of wood used.
2. How dry it is.
3. How many logs you put in.
4. The size of the logs.

The last statement means that one big log weighing 10 pounds has as much heating potential as 10 pounds of twigs. However, air cannot get at the solid log to feed the fire so the solid log will burn slowly. While you would get the same amount of heat out of either fire, the smaller the pieces of wood and the more air space around them, the faster the fire will burn.

DISPOSAL OF ASHES

Ashes should be placed in a metal container with a tight fitting lid. The closed container of ashes should be placed on a noncombustible floor or on the ground, well away from all combustible materials, pending final disposal. If the ashes are to be disposed of by burial in soil or other wise locally dispersed, they should be retained in the closed container until all cinders have thoroughly cooled.

SOFTWOOD VS HARDWOOD

Softwoods contain about 15 percent highly flammable resin which generates creosote soot in the chimney flue. Burning softwood exclusively may not be as desirable nor as safe as burning denser hardwoods. Many experienced fire-builders use small amounts of softwood kindling and newspaper in conjunction with starting a fire with split hardwood logs. Here are some guidelines to remember:

1. Softwoods produce fast warming and shorter fires. Hardwoods burn less vigorously, have shorter flames and produce steady, glowing coals.
2. As a general rule, denser woods contain more potential heat per pound. Most softwoods offer moderate heat value per pound.
3. Different woods vary widely in flame heights, flame intensities, smoke characteristics and in sparking. Most hardwoods do not spark.
4. Most freshly cut "green" wood will not burn well and will smoke. Green wood can be from 10 to 40 percent less efficient than air-dried seasoned wood.
5. Moisture and resin found inside unseasoned wood cells will build up pressure under heat and explode as sparks.

6. Most wood needs to be seasoned 9 to 12 months to reduce the moisture content and produce good steady fires. When moisture content is reduced from 60 to 20%, the gain in heat potential is nearly 7%.

7. Proper storage of wood, especially during seasoning, is essential. We recommend that you:

- a. Never store wood on the ground. This will cause rotting and insect infiltration. Raise wood on flat rock or scrap wood.
- b. Stack wood loosely to allow air circulation.
- c. Store wood where it will not be excessively exposed to weather, such as under a tarp or under a roof.
- d. Do not stack wood directly against the walls of your home.

8. Be a knowledgeable wood buyer. There is a difference in cord sizes. A standard cord stack of logs is 4 ft. high by 8 ft. long by 4 ft. deep or the equivalent of this cubic footage, (Figure 1).

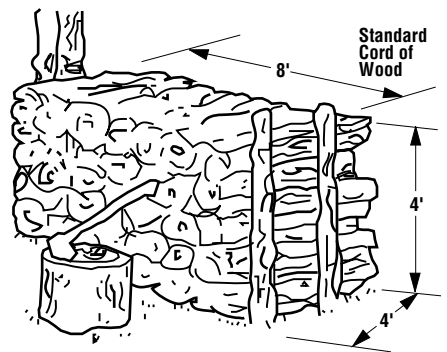

Figure 1

A face cord is the same height and length as a standard cord but the depth is only the length of the logs (12, 18 or 24 inches). A face cord can contain as little as 25% of the wood found in a standard cord.

If you buy by the ton, remember that wood becomes lighter as it dries. When buying green or wet wood, ask for some extra poundage to allow for the extra water you will be getting.

9. When comparing woods of the same moisture content and same species, we find most woods have approximately the same heating potential per pound.

However, most wood is sold by volume, not by weight. To determine the best heating source, look at the density of various wood types. (Density is the weight for a given size.) The higher the density, the more potential heat output. A standard cord has a volume of 128 cubic feet. This figure also includes the air space between and around the wood. The actual volume in a standard cord is between 60 and 100 cubic feet; depending on how tightly the wood is packed.

Assuming that you are comparing two standard cords of different species but the same volume and moisture content, the denser species will provide more BTU's. The table of wood species/densities reveals more helpful guidelines.

HARDWOODS	DENSITY
Alser, Red	.41
Ash	.49-.60
Aspen	.38-.39
Basswood, American	.37
Beech, American	.64
Birch	.55-.65
Butternut	.38
Cherry, Black	.50
Chestnut, American	.43
Cottonwood	.34-.40
Elm	.60.63
Hackberry	.53
Hickory, Pecan	.60.66
Hickory, True	.69-.75
Honey locust	.66 (est.)
Locust, Black	.69
Magnolia	.48-.50
Maple	.48-.63
Oak, Red	.59-.67
Oak, White	.64-.88
Poplar	.42
Sassafras	.42
Sweet gum	.52
Sycamore, American	.49
Tanoak	.64 (est.)
Tupelo	.50
Walnut, Black	.55
Willow, Black	.39
SOFTWOODS	DENSITY
Bald cypress	.46
Cedar	.31-.47
Douglas Fir	.46-.50
Fir	.32-.43
Hemlock	.40-.45
Larch, Western	.52
Pine	.39-.59
Redwood	.35-.40
Spruce	.35-.41
Tamarack	.53

STARTING A FIRE

1. To start a fire in a fireplace properly, first check the operation of the flue damper.
2. To prevent smoking at start-up, close any window located near the fireplace when first lighting a fire. The closed windows may be reopened once a chimney draft is drawn in the fireplace.

DAMPER CONTROL

This fireplace is fitted with a manually controlled chimney damper. The chimney damper should be closed when the fireplace is not in use to prevent cold air from entering the home through the chimney system.

The damper is controlled through the use of a control lever located within the firebox opening at the top center just behind the firebox lintel (*Figure 2*).

The control lever snaps into place at the extreme range of motion, up and back in the closed position. When pulled forward and down, the damper is open.

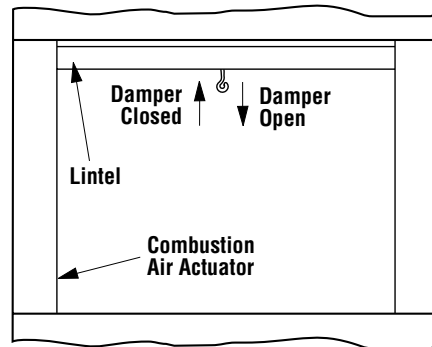

Figure 2

The appliance flue damper must always remain open when operating.

2. The grate in the firebox should be centered on or over the bottom hearth so your fire can breath properly. Crumble and twist plenty of newspapers UNDER the grate and criss-cross some small dry kindling sticks on top of the paper or on the bottom of the grate.
3. Build a pyramid of three split logs (split will start much faster). Arrange the uneven wood to provide plenty of air space between.

4. Now, light the paper at both sides of the firebox.

5. Close the screens to prevent the escape of sparks and embers.

6. Close the damper only when your fire is completely out and ashes are cold. Keep closed when fireplace is not in use to prevent unnecessary loss of heated or cooled air.

GLASS DOOR OPERATING SAFETY PRECAUTIONS AND INSTRUCTIONS

These fireplaces may be equipped with glass doors. Refer to the end of this document for a listing of the glass doors approved for use with these fireplaces.

WARNING: IF YOUR FIREPLACE IS EQUIPPED WITH GLASS DOORS, IT SHOULD BE OPERATED WITH THE DOORS FULLY OPEN OR FULLY CLOSED. IF THE DOORS ARE LEFT PARTIALLY OPEN, GAS AND FLAMES MAY BE DRAWN OUT OF THE OPENING, CREATING RISKS OF BOTH FIRE AND SMOKE. REFER TO FIGURE 3 FOR PROPER OPERATING CONDITIONS.

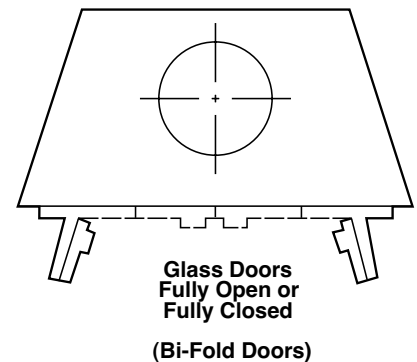

Figure 3

CAUTION: IF A SMOKING CONDITION EXISTS, GLASS DOORS SHOULD BE CLOSED DURING FIREPLACE OPERATION.

Care and Cleaning of Your Glass Doors

Never clean the glass when the doors are hot. Do not use ammonia or ammonia based glass or household cleaner to clean the glass or the door frame. An ammonia based cleaner will damage the finish of the glass door.

Clean the glass doors by wiping with a damp towel followed by a clean dry towel to remove streaks.

Remove stubborn stains from the glass with a mild soap solution and a towel dampened with clean water. Dry with a clean dry towel.

- The fire must always be confined within the boundaries of the fuel grate.
- The fireplace screens must always be closed whenever the fireplace is being used.
- Never slam the glass door since it could cause the glass to break.
- Do not build excessively large or hot fires — scorching or discoloring of the plated brass trim may occur.
- Extreme temperature changes can cause glass breakage — do not build a hot fire and close the glass doors if the doors are cold.
- If the tempered glass pane becomes scratched or chipped, it creates a weakness in the glass which can cause the glass to break when heated. Replace the pane of glass by contacting your nearest dealer.

CAUTION: GLASS AND METAL FRAMES GET HOT — ALWAYS USE HANDLES TO OPEN AND CLOSE THE DOORS.

WARNING: BE AWARE THAT SAFETY GLASS IS UNPREDICTABLE WHEN HOT AND MAY BREAK, EXPPELLING HOT GLASS INTO THE ROOM. ADVISE ALL FAMILY MEMBERS TO REMAIN WELL AWAY FROM THE FIREPLACE WHEN OPERATING WITH DOORS CLOSED TO AVOID ANY POSSIBLE PERSONAL INJURY.

IMPORTANT: Plated polished brass glass doors may have a plastic covering over all brass pieces for protection during shipping and handling. The plastic covering should be removed before installation of the glass doors. Under the plastic covering is a protective lacquer coating which should not be removed. In some instances, if it is removed, irreversible damage to the brass finish could occur. Refer to the following for specific information on plated polished brass.

IMPORTANT: The lacquer coating on the polished brass glass doors and trim pieces can be damaged or removed causing corrosion and/or tarnish. Do not remove the protective lacquer coating from plated polished doors and trim. To help protect the finish; use a non-acidic wax and avoid the over-spray of acidic/alkali based glass cleaners on the brass pieces. Please understand that the heat of the fire will cause the protective lacquer finish to slightly change to a light caramel color. Do not be alarmed as this is a normal occurrence.

COMBUSTION AIR

A proper amount of combustion air is important for your fireplace. Fireplaces consume large amounts of oxygen.

It is important to allow an adequate supply of air. If the fireplace is not equipped with an outside air kit, it may not obtain sufficient amounts of combustion air from inside the house or structure in which it is installed. Therefore, the fire may draw from an outside air source and pull air in through the chimney. This may cause smoke spillage into the room.

Smoke spillage often occurs when a fire is first started, until the fireplace and the chimney has had the opportunity to “come up to temperature” and to begin to function normally. If smoke spillage problems persist, a window may be opened just a crack to allow the proper flow of combustion air to the fireplace.

If your fireplace is equipped with an outside combustion air kit, keep it open at all times when fire is burning and close when fire is out to prevent cold air intrusion.

Combustion Air Control

The actuator for combustion air system is standard on all fireplaces but must not be operated if the complete system is not installed. See *Figure 4* and refer to *Figure 2*.

If you have reason to believe that you do not have a complete outside combustion system, contact your distributor to have your fireplace inspected for the presence of the complete system before you use the combustion air actuator. DO NOT assume that you have this system in place because you have an actuating lever present on your fireplace front face.

WARNING: DO NOT OPERATE THE COMBUSTION AIR ACTUATOR UNLESS A COMPLETE OUTSIDE COMBUSTION AIR VENT SYSTEM HAS BEEN INSTALLED WITH YOUR FIREPLACE.

To provide outside combustion air to the firebox, the LBR and LBC Series fireplaces have a pre-installed control lever. A cover plate has been mounted over this control lever only if the outside air kit has not been attached. The control lever is located on the left hand or closed side of the fireplace behind the screen. To open the air damper, pull the lever all the way out. To close, push the lever all the way in. (*Figure 4*)

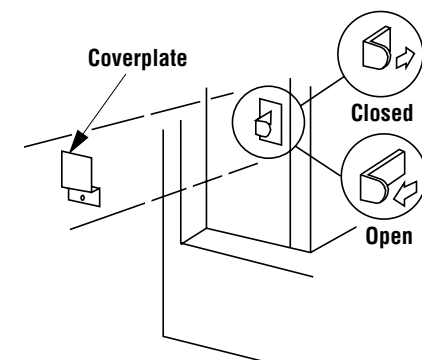

Figure 4

REFRACTORIES

All fireboxes contain a furnace refractory floor, sides and back. These refractories are reinforced with steel, but can be broken by improper use. Dropping logs on the bottom refractory and building fires directly against the refractories can cause premature burnout of these components. It may easily be repaired or replaced at costs far below repair and maintenance for masonry fireplaces.

Proper care and “burn-in” of the firebox will prolong the period of enjoyment without extensive maintenance. For the first few uses, build small fires – not roaring infernos. The materials used in the refractories contain and absorb moisture. It is important to “cure” the refractories by building only modest fires. Under normal usage, it is expected that hairline cracks will appear in the refractory surface. These hairline cracks do not affect the safe operation of the fireplace.

MAINTENANCE GUIDELINES

Your fireplace is designed to operate trouble-free with minimum maintenance. However, like any fine appliance, it deserves and requires some housekeeping attention.

Your fireplace will perform better – and certainly look more attractive to family and friends – if it is cleaned before each use. Before the first seasonal use in Autumn and after the last fire in Spring, it is important to inspect the fireplace system carefully. We recommend at least two complete fireplace inspections a year.

Before Each Use

1. Clean the firebox of excessive ashes. Some owners prefer to leave a small layer to insulate the cold refractory below the grate which helps fire starting.

This fireplace has a factory supplied grate attached, it is permissible to remove the grate for cleaning; however, the grate must be re-attached to the fireplace before the next burn.

2. Keep the fireplace screens clean so combustion air flows freely.

3. Spot check the brick-like refractory for small cracks. Heat from the fire expands it slightly. When it cools, it contracts.

Refractories should be replaced when:

1. The crack opens more than ¼" (19 mm).
2. Pitting in the surface is extensive and pits become deeper than ⅜" (4.76 mm).
3. Any piece of refractory larger than 2" (51 mm) in radius and ⅜" deep becomes dislodged.

If conditions 1, 2 or 3 occur, the refractory should be replaced.

TWICE A YEAR CHECK-UP

Normally, twice a year, you should inspect your fireplace following this list:

1. Inspect the opening in your chimney top and remove any debris that could clog it. The cap is usually held in place by four (4) screws, which remove easily for checking or cleaning the full length of the flue from above. Remove the chimney top while wearing gloves to guard against any sharp metal edges.

2. Inspect the entire flue from the top down for obstructions such as birds nests, leaves, etc. This may be done by using a flexible handled chimney cleaning brush. If the chimney contains offset/return elbows; a soft brush cleaning from the top down to any elbow and then from the firebox up to the offset/return section is the proper method. The beam from a powerful flashlight will help in this inspection.

3. Look up from inside the fireplace (damper open) to see any obstructions in the lower flue area. If present, shut the damper and glass doors (if installed) to seal the firebox and contain any soot that might fall.

If you do not have glass doors installed, a damp sheet covering the fireplace opening and sealed with masking tape will do. Then clean the flue from the top down (if an offset system, clean per Step 2) using a proper size chimney brush with flexible pole sections. Don't open the doors or remove the sheet until all soot has settled. Vacuum, don't sweep.

4. Check the metal flashing and seals around your chimney. Seal any cracks or loose nail-head openings to prevent roof leaks.

5. Clean the firebox thoroughly by using a soft brush or equivalent.

WARNING: CONTINUED OVERFIRING CAN PERMANENTLY DAMAGE YOUR FIREPLACE SYSTEM. SOME EXAMPLES OF OVERFIRING ARE:

- **BURNING QUANTITIES OF SCRAP LUMBER, PINE BRANCHES, PAPER OR CARDBOARD BOXES WHICH EXCEED THE VOLUME OF THE NORMAL LOG FIRE.**
- **USE OF ARTIFICIAL WAX BASE LOGS, TRASH OR OTHER CHEMICALS OR CHEMICALLY TREATED COMBUSTIBLES.**

CREOSOTE FORMATION AND REMOVAL

When wood is burned slowly, it produces tar and other organic vapors, which combine with expelled moisture to form creosote. The creosote vapors condense in the relatively cool chimney flue of a slow-burning fire. As a result, creosote residue accumulates on the flue lining. When ignited, this creosote makes an extremely hot fire.

The chimney should be inspected at least twice yearly during the heating season to determine if a creosote build-up has occurred.

If creosote has accumulated, it should be removed to reduce the risk of a chimney fire.

If creosote build-up is found, do not use chemical chimney cleaners that are poured on a hot fire. The chemical cleaners can be dangerous and generally only work on the flue section nearest the fire, leaving the rest of the flue unaffected. It is best to take the time to clean the flue as previously described or have the chimney professionally cleaned by a qualified chimney sweep.

TROUBLESHOOTING No Smoking Allowed

Your new fireplace is designed not to smoke if properly installed and operated per our instructions. If you do experience a problem, here are several things to check:

1. Remember – always check to ensure your flue damper is in the open position before lighting a fire!

2. When lighting your fire, a little smoke may escape into the room – more likely if the chimney is cold. To correct this, hold a lighted newspaper up inside the firebox near the open flue damper. This will turn around any down-draft and clear the flue of cold air. As your log fire burns below, the updraft will improve as the chimney heats up.

3. Is your fire too far forward? Move it toward the back with your poker. Keep the fire well within the confines of your fuel grate.

4. Keep your fire up on the grate and the refractory below free of excessive ashes. The fire needs plenty of air movement around the logs.

5. If smoking occurs an hour or two after lighting the fire, perhaps your well-insulated house is too airtight and there is scarcely any way for replacement air to enter and feed the fire. Check to see if your outside combustion air kit (if installed) is open. Check outside to ensure no obstructions are in front of exterior air entry. Open a window slightly, open doors to one or two rooms and see if this stops the smoking.

6. Is a vent fan, exhaust hood or central heating/cooling system stealing combustion air from your fireplace? If their volume is high enough, this can cause negative pressure and an unwanted downdraft – and smoking.

7. Is your wood fuel too wet or unseasoned? Or does it contain some chemical substance that causes sputtering, smoking and toxic fumes?

8. Figure 5 illustrates the correct height of your chimney top. It is unlikely that your installation does not adhere to the installation instructions. However, if not correct, you could experience an unusual downdraft. Usually, the best solution is to increase the chimney height. This may also be necessary if nearby trees, adjoining roof lines or a hill is causing a downdraft condition.

9. Remember, your fireplace has been designed as a supplemental heating device only, it is not intended to heat your entire home.

REPLACEMENT PARTS

A complete parts list is found at the end of this manual. Use only parts supplied from the manufacturer.

Normally, all parts should be ordered through your Lennox dealer. Parts will be shipped at prevailing prices at time of order.

When ordering repair parts, always give the following information:

1. The model number of the appliance.
2. The serial number of the appliance.
3. The part number.
4. The description of the part.
5. The quantity required.
6. The installation date of the appliance.

ACCESSORY COMPONENTS

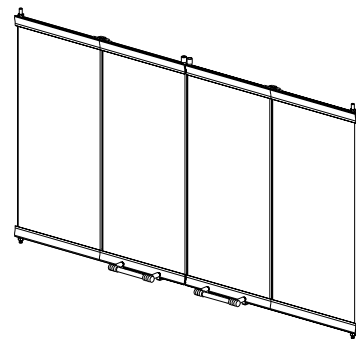

38/43LBF
38/43LBF-BB
38/43LBF-BS

Bi-Fold Doors

Bi-Fold Doors

Your fireplace can be fitted with beautiful bi-fold doors. Model LBF doors are available for use with these fireplace. Doors are easily fitted to the fireplace opening. Model LBF doors come with standard black finish. Model LBF-BB doors have a beautiful bright brass finish. Model LBF-BS doors have the striking look of brushed steel.

To ensure warranty and to prevent a potential fire hazard, do not use any other doors on these appliances.

Louver Kits		
38" Brass	91L63	38LK-B
43" Brass	91L64	43LK-B

Louver Kits

Decorative louver kits are available to enhance and beautify the front face of your fireplace. These kits are designed to attach directly to the fireplace front face over the standard louvers. They are available in an attractive bright brass finish.

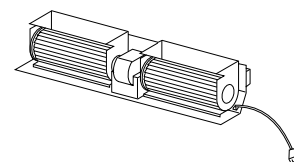

Blower Kit 12M73 LFAK-2000

Blower Kit

The LFAK-2000 blower provides for a constant velocity forced air circulation feature for your appliance.

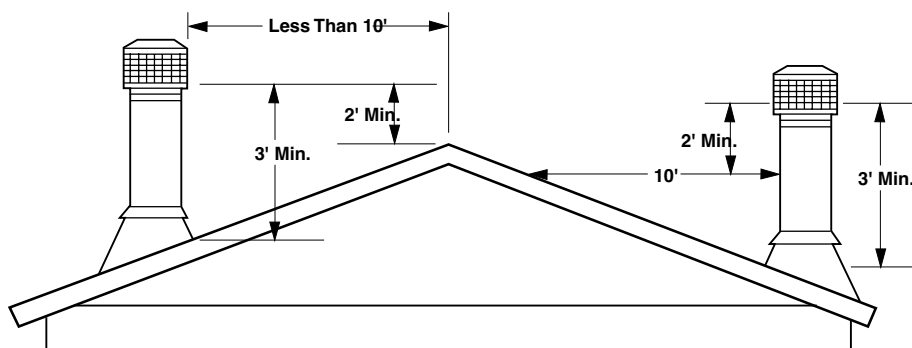

Figure 5

WARRANTY

This fireplace is covered by a limited warranty detailed separately from this document.

Retain this manual. File it with your other documents for future reference.

PRODUCT REFERENCE INFORMATION

We recommend that you record the following important information about your fireplace. Please contact your Lennox dealer for any questions or concerns. For the number of your nearest Lennox dealer, please call 1-800-9-LENNOX

Your Fireplace's Model Number	_____
Your Fireplace's Serial Number	_____
The Date On Which Your Fireplace Was Installed	_____
Your Dealer's Name	_____

REPLACEMENT PARTS

No.	DESCRIPTION	LBR/LBC-3824		LBR/LBC-4324	
		Part No.	Qty.	Part No.	Qty.
	Fireplace Assembly	-	-	-	-
1.	Firescreen	16M27	2	16M28	2
2.	Rod, Screen	16M29	2	16M30	2
3.	Refractory, Side, Right (Traditional)	16M31	1	16M31	1
	Refractory, Side, Right (Herringbone)	16M37	1	16M39	1
4.	Refractory, Side, Left (Traditional)	16M31	1	16M31	1
	Refractory, Side, Left (Herringbone)	16M38	1	16M40	1
5.	Refractory, Rear (Traditional)	16M33	1	16M34	1
	Refractory, Rear (Herringbone)	16M41	1	16M42	1
6.	Refractory Base	16M35	1	16M36	1
7.	Grate	92L91	1	92L91	1

Lennox Hearth Products reserves the right to make changes at any time, without notice, in design, materials, specifications, prices and also to discontinue colors, styles and products. Consult your local distributor for fireplace code information.



HEARTH PRODUCTS

1110 West Taft Avenue
Orange, CA 92865