

This Owner's Manual is provided and hosted by [Appliance Factory Parts](http://www.ApplianceFactoryParts.com).

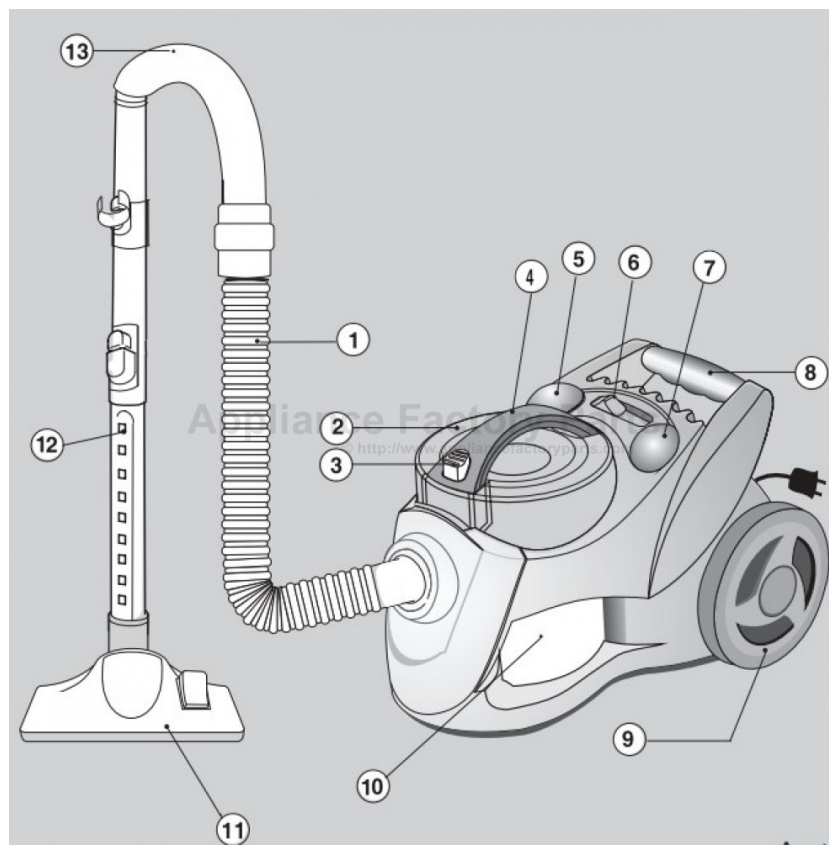

Black & Decker BLB1401 Owner's Manual

[Shop genuine replacement parts for Black & Decker
BLB1401](#)



[Find Your Black & Decker Vacuum Cleaner Parts - Select From 339 Models](#)

----- Manual continues below -----

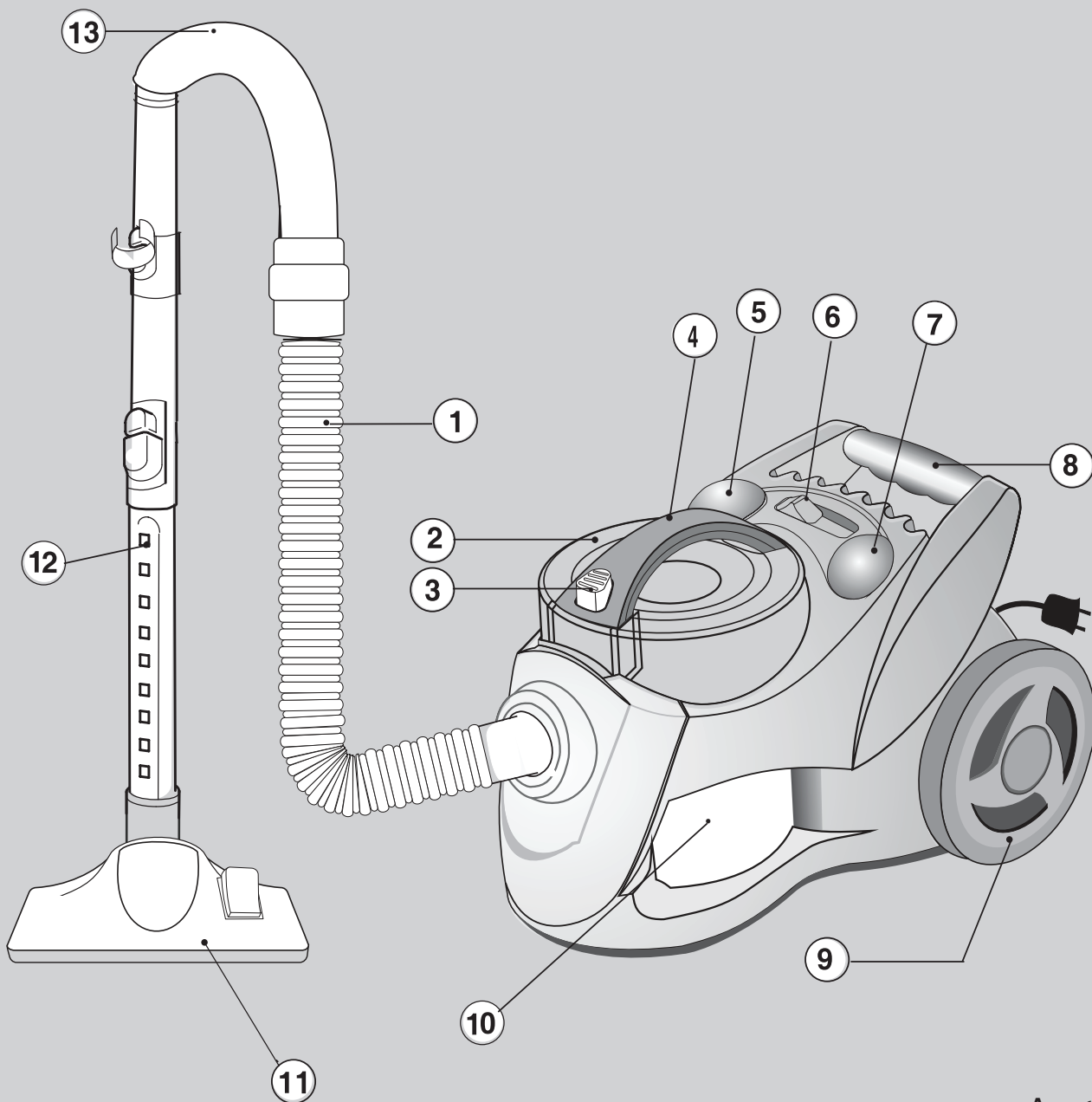

Australia

New Zealand

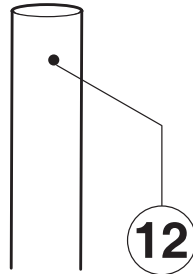
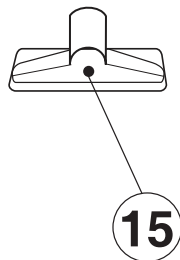
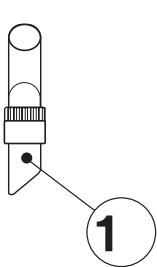
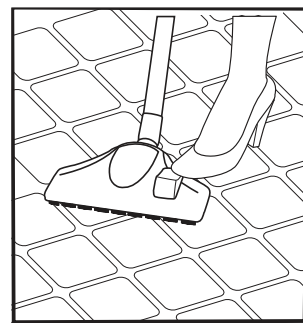
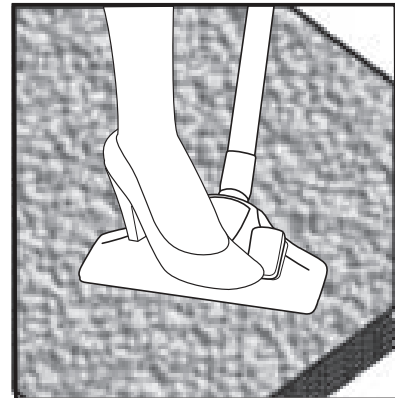
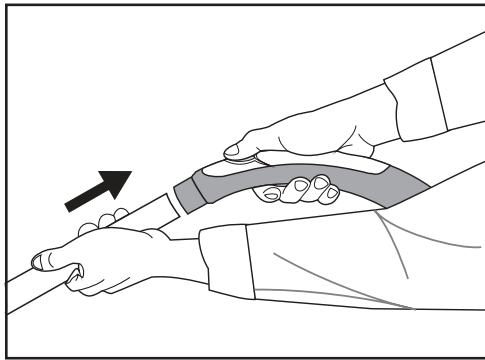

18

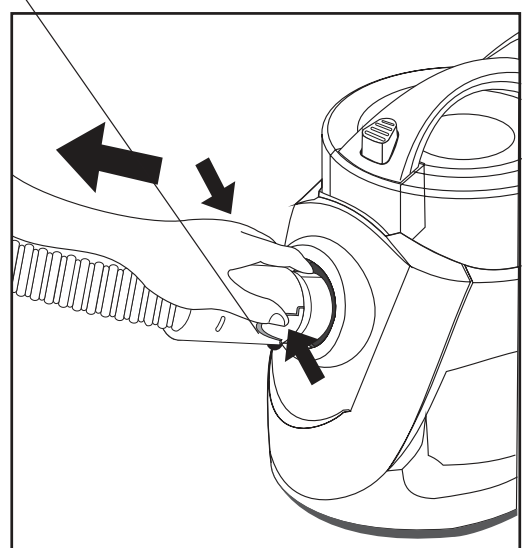
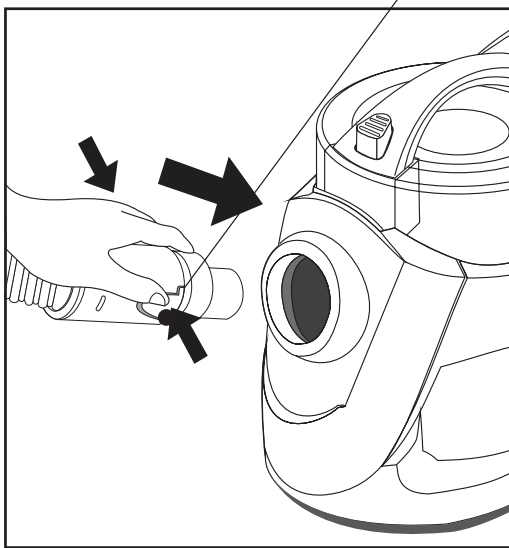

A

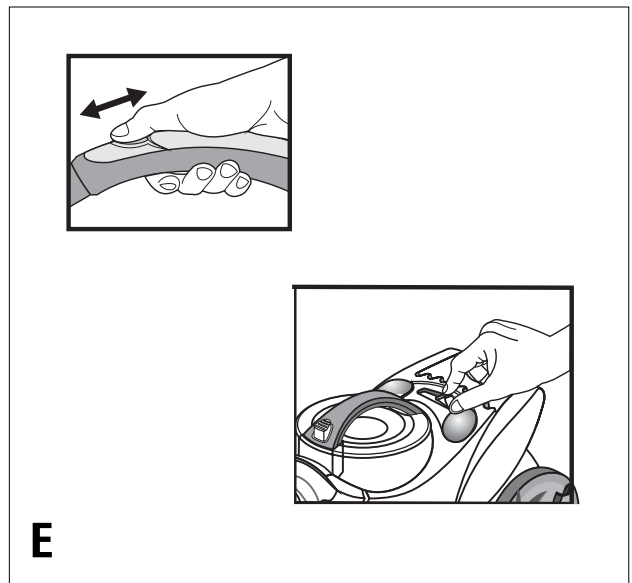
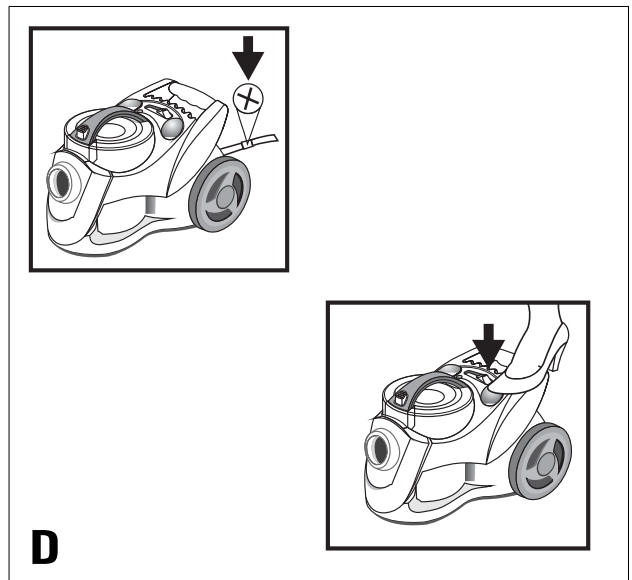
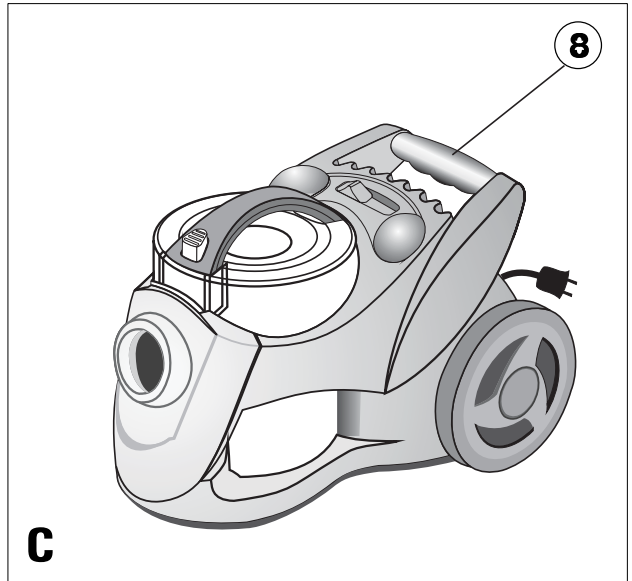
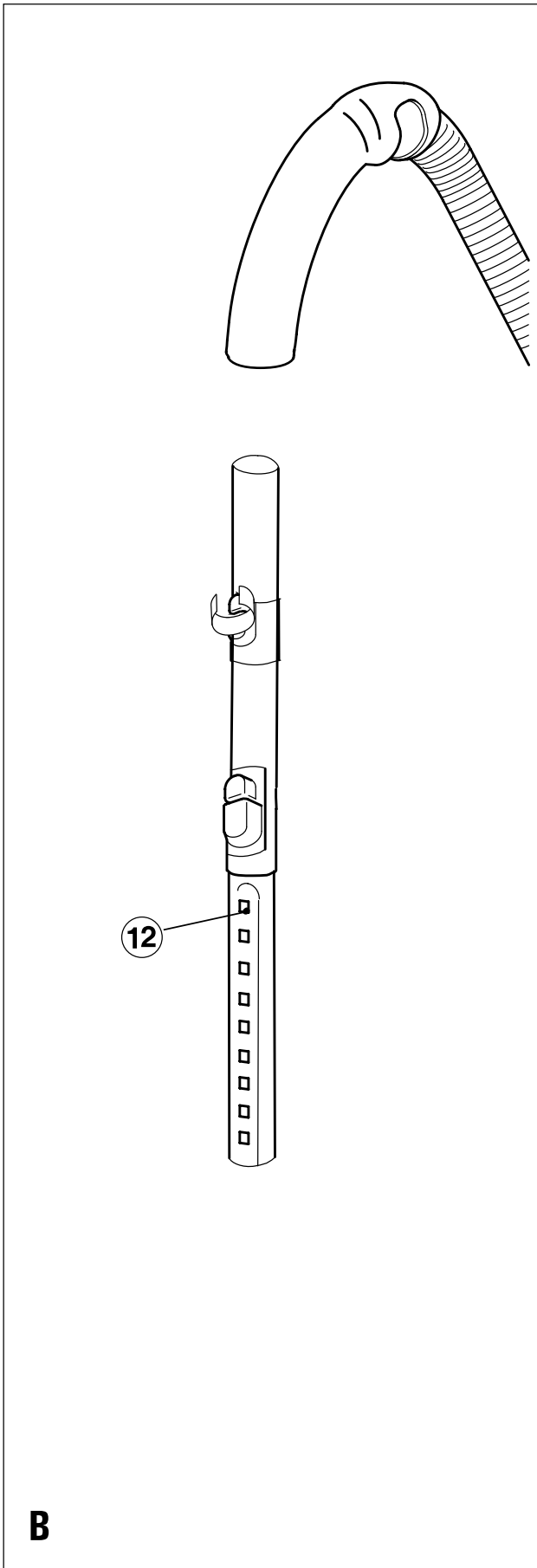

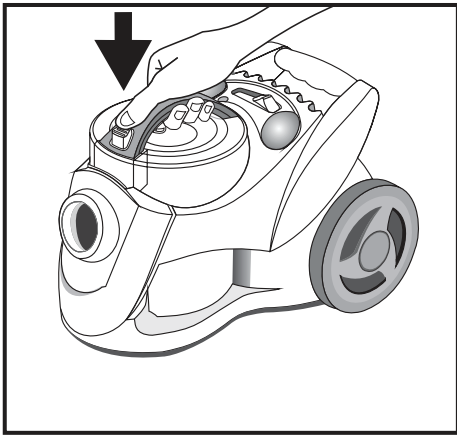

F

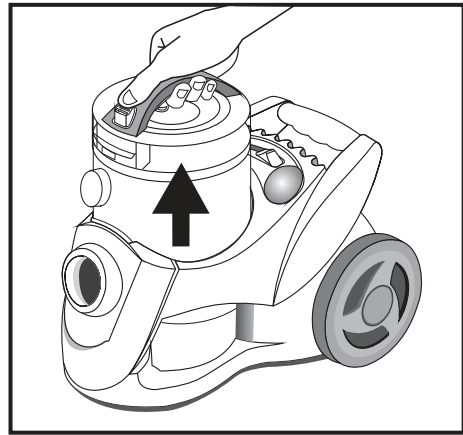

G

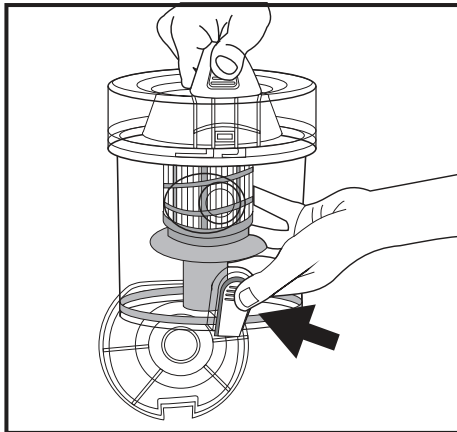

H

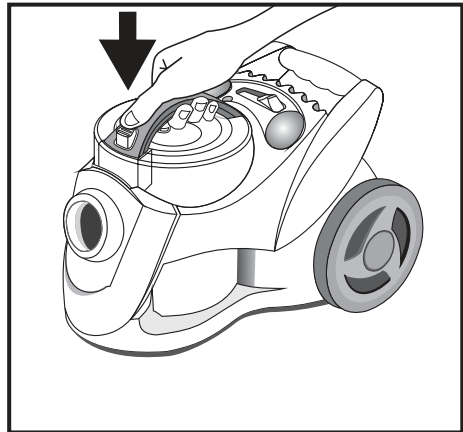

I

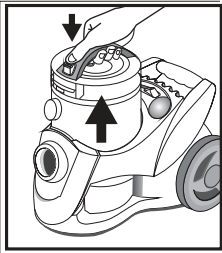

JA

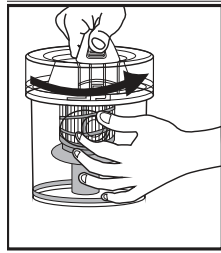

JB

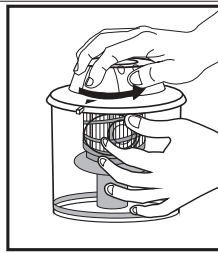

JC

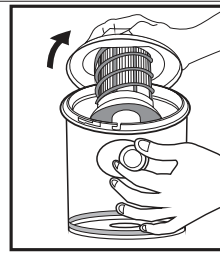

JD

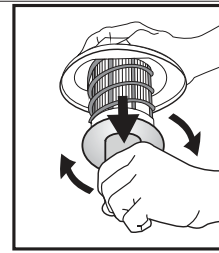

JE

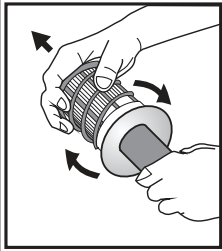

JF



JG

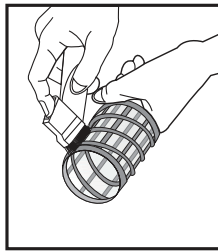

JH

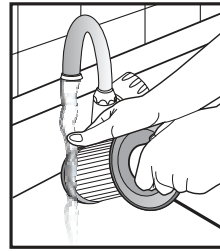

JI

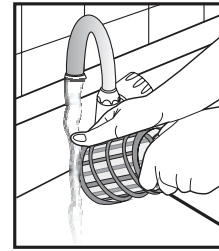

JJ

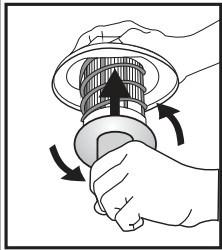

JK

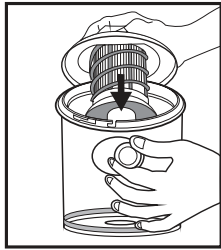

JL

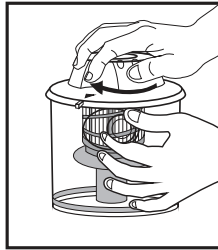

JM

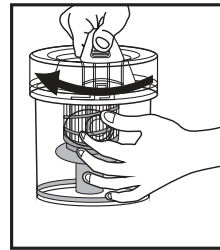

JN

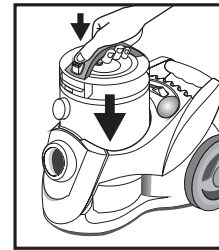

JO

J

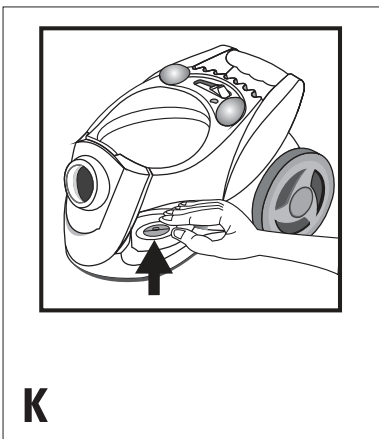

K

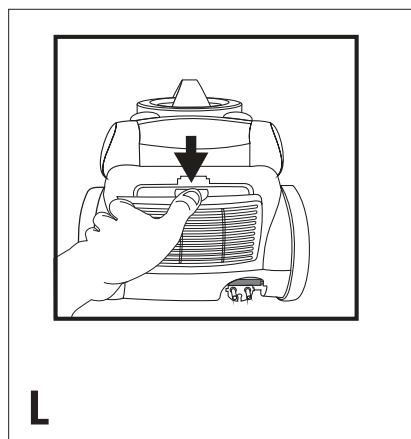

L

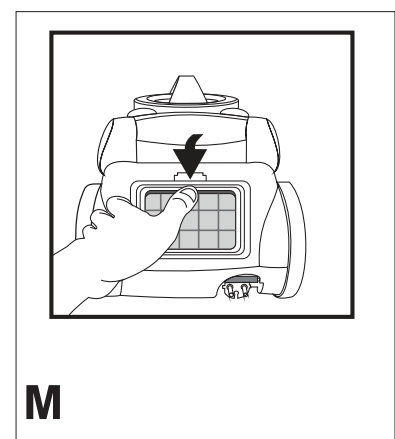

M

Intended use

Your Black & Decker vacuum cleaner has been designed to vacuum dry substances. This product is intended for household use only.

Safety instructions

Warning! When using mains-powered appliances, basic safety precautions, including the following, should always be followed to reduce the risk of fire, electric shock, personal injury and material damage.

- ◆ Read all of this manual carefully before using the appliance.
- ◆ The intended use is described in this manual. The use of any accessory or attachment or the performance of any operation with this appliance other than those recommended in this instruction manual may present a risk of personal injury.
- ◆ Retain this manual for future reference.

Using your appliance

- ◆ Make sure that the appliance is switched off before connecting to or disconnecting from the power supply.
- ◆ Always take care when using the appliance.
- ◆ Do not use the appliance outdoors.
- ◆ Never pull the power supply cord to disconnect the plug from the socket. Keep the power supply cord away from heat, oil and sharp edges.
- ◆ If the power supply cord is damaged during use, disconnect the appliance from the power supply immediately. Do not touch the power supply cord before disconnecting from the power supply.
- ◆ Disconnect the appliance from the power supply when not in use, before fitting or removing parts and before cleaning.

Safety of others

- ◆ This appliance is not intended for use by persons (including children) with reduced physical, sensory or mental capabilities, or lack of experience or knowledge, unless they have been given supervision or instruction concerning use of the appliance by a person responsible for their safety.
- ◆ Children should be supervised to ensure they do not play with the appliance.
- ◆ Do not allow children or animals to come near the work area or to touch the appliance or power supply cord. Close supervision is necessary when the appliance is used near children.

After use

- ◆ Switch off and remove the plug from the socket before leaving the appliance unattended and before changing, cleaning or inspecting any parts of the appliance.
- ◆ When not in use, the appliance should be stored in a dry place. Children should not have access to stored appliances.

Inspection and repairs

- ◆ Before use, check the appliance for damaged or defective parts. Check for breakage of parts, damage to switches and any other conditions that may affect its operation.
- ◆ Do not use the appliance if any part is damaged or defective.
- ◆ Have any damaged or defective parts repaired or replaced by an authorised repair agent.
- ◆ Before use, check the power supply cord for signs of damage, ageing and wear.
- ◆ Do not use the appliance if the power supply cord or mains plug is damaged or defective.
- ◆ If the power supply cord remains plug is damaged or defective it must be repaired by an authorised repair agent in order to avoid a hazard. Do not cut the power supply cord and do not attempt to repair it yourself.
- ◆ Never attempt to remove or replace any parts other than those specified in this manual.

Electrical safety



This tool is double insulated; therefore no earth wire is required. Always check that the power supply corresponds to the voltage on the rating plate.

Additional safety instructions for vacuum cleaners

- ◆ Before use, always make sure that the filter is correctly seated.
- ◆ Do not use the appliance to pick up liquids.
- ◆ Do not use the appliance to pick up any materials that could catch fire.
- ◆ Do not use the appliance near water. Do not immerse the appliance in water.
- ◆ Keep the motor draught away from your eyes and face.
- ◆ Keep children and animals at a safe distance when using this appliance.
- ◆ Always work from bottom up when using the appliance on stairs, and keep the appliance at least a stair below your working position.
- ◆ Do not use the appliance without the suction head or another suitable accessory mounted to the tube.
- ◆ Keep your hair, clothing and gloves away from moving parts. Do not reach into the rotating brush. Keep the rotating brush away from the power supply cord.
- ◆ Do not use damaged accessories.
- ◆ Use only Black & Decker accessories.

Features

This appliance includes some or all of the following features.

1. Hose
2. Container
3. Container release button
4. Container handle
5. Cord rewind button
6. Variable speed switch
7. On/off switch
8. Handle
9. Wheels
10. Hepa filter
11. Suction head
12. Telescopic wands
13. Hose handle and air flow control

In addition, this appliance is supplied with some or all of the following accessories (fig. A):

14. Crevice combo brush tool
15. Upholstery brush.

Assembly

Connecting the hose (fig. A)

- ◆ Insert the hose connector into the inlet of the appliance.
- ◆ Line up the hose connector tabs with the slots in the inlet.
- ◆ Slide the hose further until the release buttons (18) (2 positions) click into place.
- ◆ To disconnect the hose, press the release buttons (18) (2 positions) and pull out the hose.

Mounting the extension tube (fig. A)

- ◆ Slide the hose nozzle (13) into the tube (12) until it locks into place.
- ◆ To remove the tube (12), grip firmly and pull the hose nozzle (13) out of the tube.

Mounting the suction head (fig. A)

The suction head (11) allows for vacuuming on carpet and hard surfaces (e.g. laminate and tiles).

- ◆ Slide the tube (12) into the head (11) until it locks into place.
- ◆ To remove the head (11), grip the head firmly and pull the tube (12) out of the head (11).

Mounting accessories (fig. A)

The crevice tool (14) allows for vacuuming in narrow and hard to-reach places. The brush tool (14) allows for vacuuming on furniture, blinds, curtains, windows and stairs.

- ◆ Slide the accessory onto the hose nozzle (13) or the tube (12).
- ◆ To remove an accessory, pull the accessory off.

Use

Unwinding and rewinding the cord (fig D)

The cord rewind button (5) can be operated by hand or foot.

- ◆ Before use, pull the full length of cord from the back of the appliance. Pull out till the yellow marker is visible. Do not pull the cord further when the red marker becomes visible.
- ◆ After use, press the cord rewind button (5) to store the cord back into place. Manually guide the cord to ensure it does not swing back. Ensure the plug is correctly located.

Adjusting the length of the wand (fig. B)

The telescopic wand (12) is made up of two pieces.

- ◆ To extend the lower tube, press the adjustment button and slide out the second tube until it is fully extended and clicks into place.

Adjusting the suction head (fig. A)

- ◆ For vacuuming on carpets, switch the floor surface selector into the up position.
- ◆ For vacuuming on laminates, tiles, etc., switch the floor surface selector into the down position.

Switching on and off

- ◆ The on/off switch (7) can be operated by hand or foot.
- ◆ To switch the appliance on, press the on/off switch (7).
- ◆ To switch the appliance off, press the on/off switch (7) again.

Adjusting the airflow (fig. E)

- ◆ Slide the airflow control switch to adjust the airflow as desired. Max and min positions are shown.
- ◆ Slide the variable speed control (6) on the vacuum body change the motor speed hence the suction.

Vacuuming

- ◆ When operating the appliance, make sure that the hose is not trapped, twisted or blocked
- ◆ In case of overheating, a cut-out will operate and the appliance will automatically stop.
- ◆ If the appliance stops operating, unplug the appliance and allow it to cool for 2-3 hours.

Hint for optimum use

- ◆ When vacuuming stairs, always start at the bottom and work your way up. Position the appliance on the floor and do the stairs until halfway. Then carry the appliance to a stable position which is at least one stair below your working position, and do the top half of the stairs.

Carrying the appliance (fig. C)

During use the appliance can be carried using the handle (8).

Storing the appliance

Warning! When storing the appliance, switch the appliance off and unplug it.

- ◆ Make sure that the cord is fully rewound.
- ◆ Place the appliance in an upright position.
- ◆ Wrap the hose around the appliance.
- ◆ Store the appliance in a dry location. The appliance can be carried by the container handle (4).

Maintenance

Your Black & Decker tool has been designed to operate over a long period of time with a minimum of maintenance. Continuous satisfactory operation depends upon proper tool care and regular cleaning.

The appliance is fitted with a Hepa style filter. When the suction is reduced an indicator light illuminates and glows red.

- ◆ After every use or when the indicator glows red switch off and empty the container. (fig F-I).
- ◆ Ensure the container is securely replaced.
- ◆ After every use switch the appliance off and unplug from the mains.

This will ensure that the next time the appliance is used the performance is at its optimum.

Warning! Before performing any maintenance or cleaning on the appliance, unplug the appliance.

- ◆ Regularly clean the ventilation slots in your appliance using a soft brush or dry cloth.
- ◆ Regularly clean the motor housing using a damp cloth. Do not use any abrasive or solvent-based cleaner.

Emptying the container (fig. F - I)

The container (8) must be emptied when the dirt fills to the maximum mark indicated on the bin.

- ◆ Remove the container (2) from the appliance by pressing the release button (3) and lifting the container out of the appliance.
- ◆ Press the lower door latch (fig H) to release the dirt.
- ◆ Empty the container as necessary.
- ◆ Clean the filter if necessary as described below.
- ◆ Close the lower door and make sure that it clicks into place.
- ◆ Re-fit the container (2) into the appliance, make sure that the release button (3) clicks into place.

Filter cleaning and maintenance.

To obtain maximum efficiency it is recommended to clean the filters in the following manner.

The filters upstream of the motor when they are dirty. At least once a year wash with water and let the filters air dry completely before replacing in the vacuum. (at least 24 hours).

Do not dry with a hair dryer or place on a heater etc or the filters will be damaged.

If the filters are damaged replace with new filters.

Cleaning

Warning! Before cleaning and maintenance, switch the appliance off and unplug it.

- ◆ From time to time wipe the appliance with a damp cloth. Do not use any abrasive or solvent-based cleaner. Do not immerse the appliance in water.

Cleaning the container filter (fig. J. (JA - JO))

The container filter prevents dust and dirt from entering the motor housing. The filter is re-usable and should be cleaned periodically.

- ◆ Remove the container from the appliance (fig. JA) by pressing the button on top of the dust container to release the dust container and lift it out by the handle.
- ◆ Support the dust container and turn the handle anti-clockwise to remove the lid/handle. (fig JB).
- ◆ Continue supporting the dust container and turn the HEPA filter mount anti-clockwise to disengage and remove the assembly from the dust container. (fig JC and JD).
- ◆ To remove the internal HEPA filter from the mount assembly turn the filter anti-clockwise whilst supporting the internal lid. (fig JE).
- ◆ Then turn the lid of the filter anti-clockwise to release the filter lid. (fig JF).
- ◆ Clean the filter and its lid carefully using a small brush or wash it in running water. (fig JG to JJ). Air dry the two parts before putting back into the vacuum cleaner.
- ◆ Put the cleaned and dried lid on the HEPA filter and turn it clockwise to lock together. (fig JK).
- ◆ Replace the interior lid and HEPA filter assembly in the dust container such that the arrow symbol on the lid corresponds with the red mark on the dust container, and close the container by pressing on and turning the assembly clockwise. (fig JL, JM).
- ◆ Replace the dust container lid/handle on the dust container and turn it clockwise to lock into position. (fig JN).

- ◆ Press the dust container release button (on top of the duct container) and replace the dust container in the vacuum. (fig JO).

Cleaning the motor filter (fig. K)

The motor filter prevents particles and larger objects from entering the motor housing when the container is removed.

The filter is re-usable and should be cleaned regularly.

- ◆ Remove the container from the appliance.
- ◆ Take the filter out (fig. K).
- ◆ Brush any loose dust off the filter.
- ◆ Replace the filter.
- ◆ Re-insert the container into the appliance.

Replacing the filters

If the HEPA filter (10) (fitted inside the container) is damaged or fails to operate properly, it must be replaced. Replacement filters are available from your Black & Decker dealer (part. no. 764468-00).

Replacing the container filter

- ◆ Proceed as described above to replace the filter (10).

Replacing the outlet filter (fig. L & M)

The appliance is fitted with a lifetime filter but if it is required to be replaced, replace it as follows:

- ◆ Remove the cover by pressing down on the locking tab.
- ◆ Remove the old filter by pulling it out.
- ◆ Insert the new filter as shown.
- ◆ Refit the cover.

Protecting the environment



Should you find one day that your tool needs replacement, or if it is of no further use to you, think of the protection of the environment. Black & Decker repair agents will accept old Black & Decker tools and ensure that they are disposed of in an environmentally safe way.



Separate collection of used products and packaging allows materials to be recycled and used again. Re-use of recycled materials helps prevent environmental pollution and reduces the demand for raw materials.

Local regulations may provide for separate collection of electrical products from the household, at municipal waste sites or by the retailer when you purchase a new product.

Black & Decker provides a facility for the collection and recycling of Black & Decker products once they have reached the end of their working life. To take advantage of this service please return your product to any authorised repair agent who will collect them on our behalf.

You can check the location of your nearest authorised repair agent by contacting your local Black & Decker office at the address indicated in this manual.

Technical data

		BLB1401-XE
Voltage	Vac	220-240
Frequency	Hz	50
Power input	W	1400
Cable length	m	6
Container size	l	0.8
Weight	kg	6.0

Guarantee

Black & Decker is confident of the quality of its products and offers an outstanding guarantee. This guarantee statement is in addition to and in no way prejudices your statutory rights.

If a Black & Decker product becomes defective due to faulty materials, workmanship or lack of conformity, within 24 months from the date of purchase, Black & Decker guarantees to replace defective parts, repair products subjected to fair wear and tear or replace such products to make sure of the minimum inconvenience to the customer unless:

- ◆ The product has been used for trade, professional or hire purposes.
- ◆ The product has been subjected to misuse or neglect.
- ◆ The product has sustained damage through foreign objects, substances or accidents.
- ◆ Repairs have been attempted by persons other than authorised repair agents or Black & Decker service staff.

To claim on the guarantee, you will need to submit proof of purchase to the seller or an authorised repair agent. You can check the location of your nearest authorised repair agent by contacting your local Black & Decker office at the address indicated in this manual.

TRADE PRACTICES ACT 1974 (AUSTRALIA) & CONSUMERS GUARANTEE ACT 1993 (NEW ZEALAND).

The provisions of the Black & Decker Home Appliances Replacement Guarantee as set out above are in addition to the conditions and guarantees which are mandatorily implied by law through Trade Practices Act 1974 (Australia) and the Consumer Guarantee Act 1993 (New Zealand) and legislation.

The Black & Decker Guarantee supplements these rights.

DESIGNED FOR DOMESTIC PURPOSES ONLY.

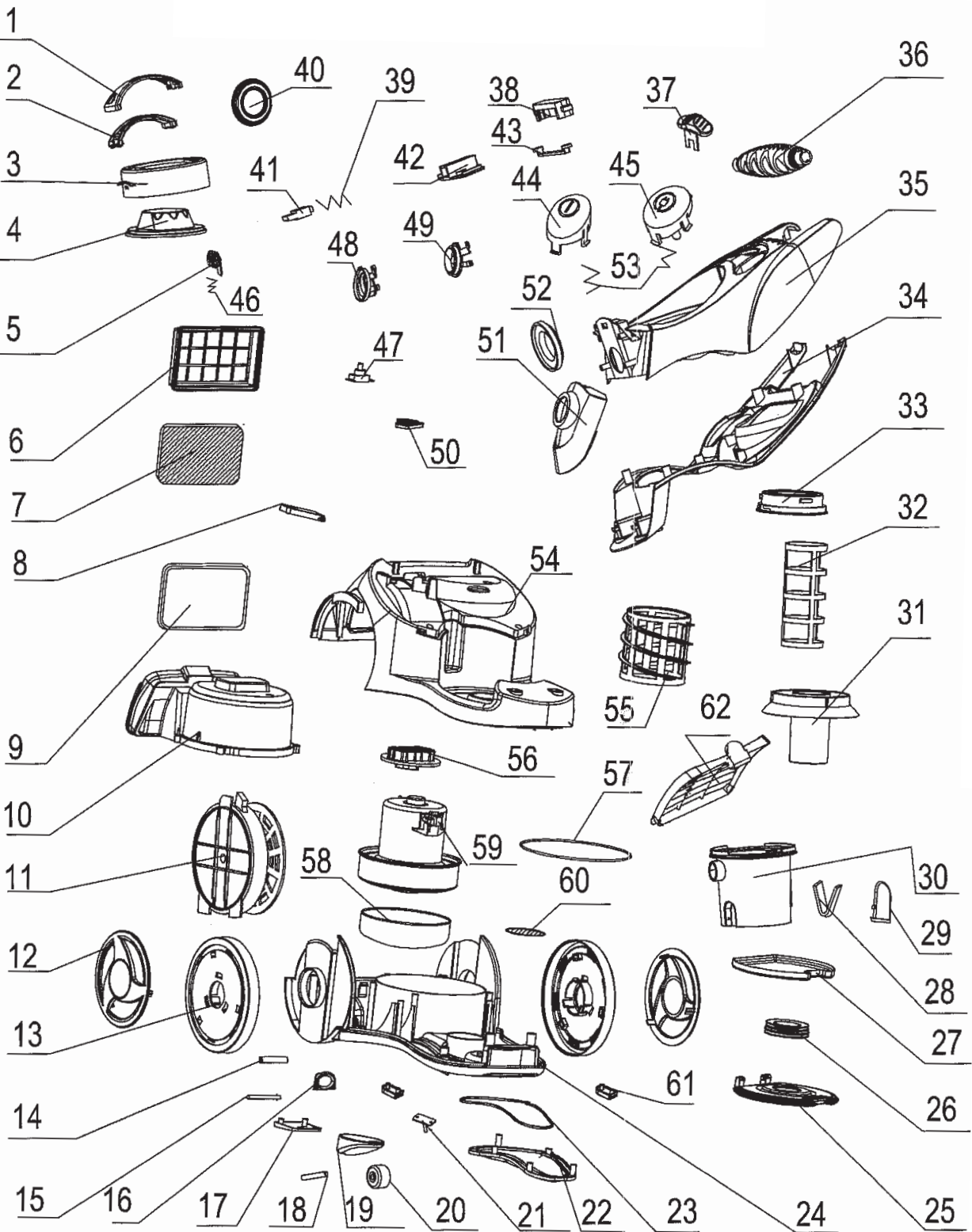

AUSTRALIA

Black & Decker (Australia) Pty Ltd.

20 Fletcher Road

MOOROOLBARK Victoria 3138

Tel: (03) 8720 5100

Fax: (03) 9727 5940

NEW ZEALAND

Black & Decker New Zealand Pty Ltd.

5 Te Apunga Place

Mt. WELLINGTON Auckland NZ.

Tel: 9 259 1111

Fax: 9 259 1122