

BROILMASTER®
PREMIUM GRILLS

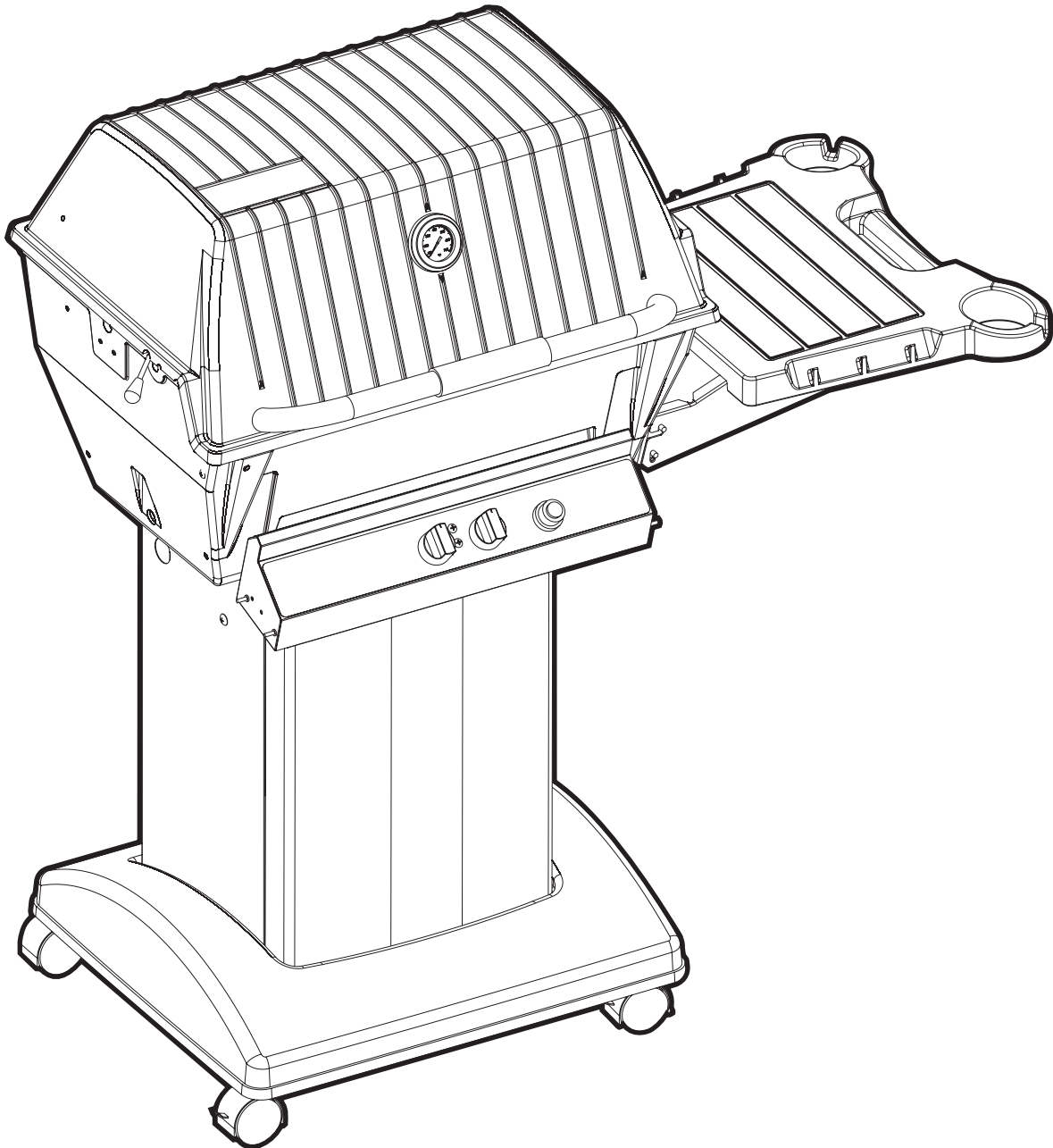

P3PK5(N)-1
P3X GRILL WITH STAINLESS STEEL CART AND ONE BLACK SHELF



IMPORTANT INFORMATION

IMPORTANT

This manual should be read thoroughly by the installer and by anyone who will use or maintain the grill.

Installer - Write the model number, serial number, and date of installation in the manual. If available, attach a copy of the receipt. Leave this manual with the grill owner.

Grill Owner - Read and retain this manual. It contains instructions on using and maintaining your grill, plus information on ordering replacement parts. Attach a copy of your receipt to this manual. Your receipt established the proof of purchase required for warranty replacement parts.

⚠ WARNING

Follow the instruction in this manual for proper installation and maintenance of the grill. Improper installation, adjustment, alteration, service or maintenance can cause injury or property damage. For assistance or additional information consult a qualified installer, service agency or the gas supplier.

⚠ DANGER: FOR YOUR SAFETY

IF YOU SMELL GAS:

1. Extinguish any open flame.
2. Shut off gas to the appliance.
3. Open the grill lid.
4. If odor continues, keep away from the appliance call your gas supplier or your fire department.

⚠ WARNING: FOR YOUR SAFETY

1. Do not store or use gasoline or other flammable vapors or liquids in the vicinity of this or any appliance.
2. Only the LP tank connected for use shall be placed in the vicinity of this grill.

⚠ CAUTION:

Parts may have sharp edges. Wear leather work gloves and handle parts carefully during unpacking, assembly and installation.

⚠ WARNING

For LP grills, use propane cylinders equipped with an Overfill Protection Device (OPD). An overfilled or improperly filled propane cylinder can be dangerous.

Thank you for purchasing a Premium Gas Grill.

Broilmaster takes pride in its reputation as the The Most Durable Grill Known to Man.

From its thick aluminum casting to its massive cooking grids, your Broilmaster is built to last. In fact we still make replacement parts for Broilmaster grills built more than 30 years ago.

Visit www.broilmaster.com and click on the Hall of Fame to see a sampling of our long-time customers. We hope you enjoy years of great meals prepared on your Broilmaster. And we hope to add your photo to the Hall of Fame one day.

Thank You!

Broilmaster is a registered trademark of

Empire Comfort Systems, Inc.

918 Freeburg Ave.

Belleville, Illinois 62220

Telephone 800-851-3153

TABLE OF CONTENTS

You have chosen the finest grill for your outdoor cooking pleasure.

Please take time to read this entire manual before assembling your Premium Broilmaster gas grill.

ASSEMBLY INSTRUCTIONS	5
P3PK5 SERIES PARTS DIAGRAM	6
CART HARDWARE PACK - B102002	7
GRILL HEAD HARDWARE PACK - B102155	8
SHELF HARDWARE PACK - B101658	9
UNPACK AND REMOVE LID	10
CART BASE ASSEMBLY	11
CART WALLS ASSEMBLY	12
ATTACH WALLS TO BASE	13
INSTALL REAR BRACE	14
INSTALL RUBBER GUARD AND BUSHING	15
INSERT BURNER HOLD-DOWN BOLT	16
ATTACH BOTTOM CASTING TO CART	17
ATTACH SIDE SHELF	18-21
WIND DEFLECTOR PLACEMENT	22
INSERT CONTROL PANEL	23
ATTACH IGNITOR WIRE	24
INSTALL BURNER ASSEMBLY	25
CONNECT IGNITOR LEADS	26
KNOB AND BATTERY PLACEMENT	27
INSTALL LID STOP	28
HEAT SHIELD PLACEMENT	29
TANK RETAINER AND GREASE CUP INSTALLATION	30
HANDLE INSTALLATION	31
REINSTALL LID	32
INSTALL RACKS	33
INSTALL WARMING RACK	34
PROPANE GAS GRILLS	35-37
CONNECTING PROPANE GAS GRILL	38-39
CONNECTING NATURAL GAS GRILL	40
NATURAL GAS GRILLS	41
COMPLETED ASSEMBLY	42
OWNER'S MANUAL FOR P3PK5 GRILLS	43-52
OPERATION - PROPANE AND NATURAL GAS GRILLS	43-44
MAINTENANCE	45
TROUBLESHOOTING	46
IMPORTANT SAFETY INFORMATION	47-48
COOKING TIPS	49
WARRANTY TERMS	50
MASTER PARTS DISTRIBUTOR LIST	51
HOW TO ORDER REPAIR PARTS	51
GRILL MAINTENANCE HISTORY	52

ASSEMBLY INSTRUCTIONS

Before You Begin

Compare the parts in the box to the parts list provided in this manual. If any are missing, contact your Broilmaster dealer before beginning assembly.

All Broilmaster grills require some assembly. For the best results, follow the step-by-step instructions.

For natural gas grills and for permanently mounted LP grills, have your gas supplier run service to the desired location first.

If you purchased an accessory with your Broilmaster, follow the instructions provided.



CAUTION:

Parts may have sharp edges. For your safety wear leather work gloves and handle parts carefully during unpacking and assembly.

3/8", 7/16" and 3/4"
REQUIRED

3/8" and 7/16"
REQUIRED

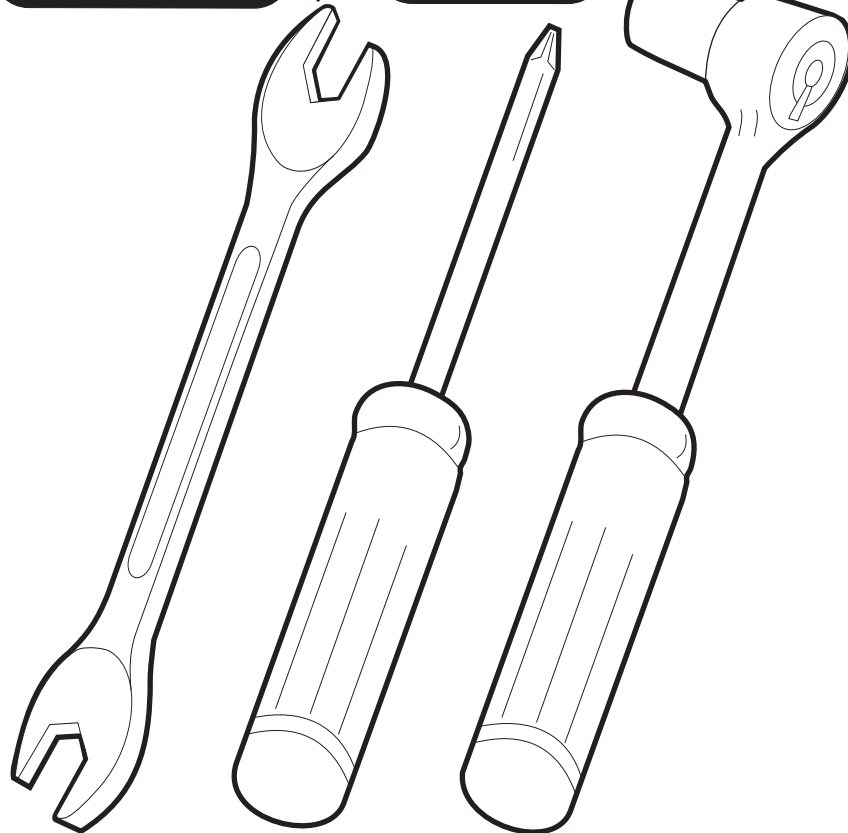

TOOLS
REQUIRED

P3PK5 SERIES PARTS DIAGRAM

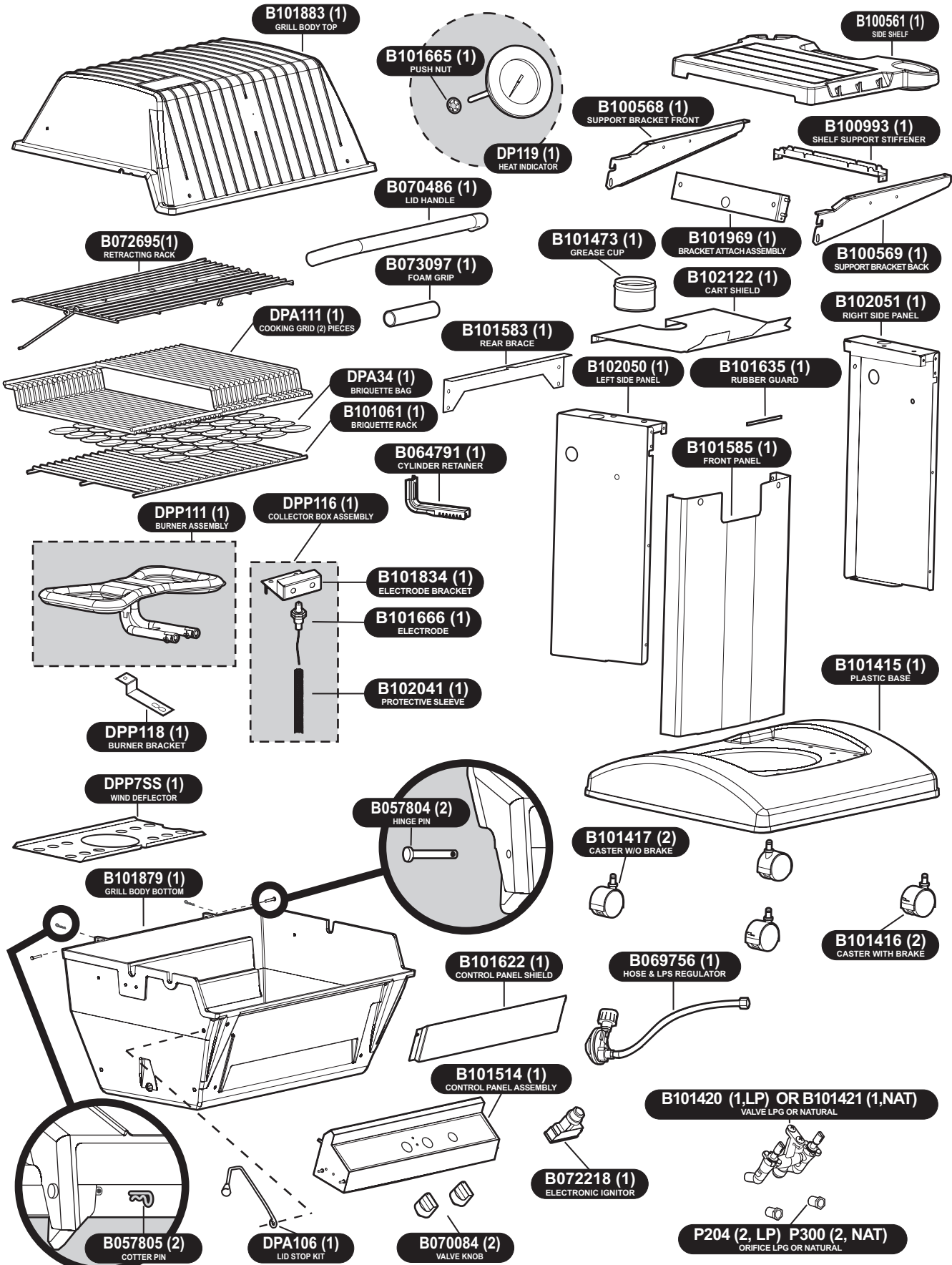

CART HARDWARE PACK - B102002

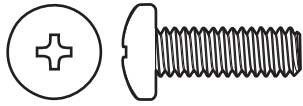

PHILLIPS PAN HEAD SCREW,
SS, 1/4-20 X 3/4
B072217
(8)

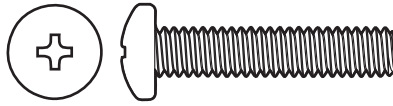

PHILLIPS PAN HEAD SCREW,
SS, 1/4-20 X 1-1/4
B100113
(1)

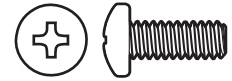

PHILLIPS PAN HEAD SCREW,
SS, 10-24 X 1/2
R4056
(6)

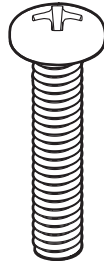
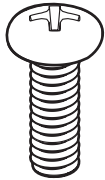

KEPS NUT,
SS, 1/4-20
B100385
(4)

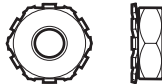

KEPS NUT,
SS, 10-24
B073967
(8)

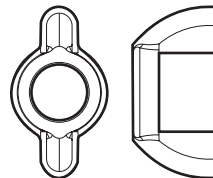

WING NUT,
1/4-20
R1123
(1)

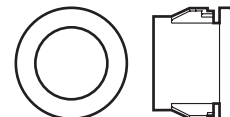

SNAP BUSHING,
1/2"
R896
(1)

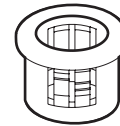

LOCK WASHER,
1/4 ID X 1/2 OD
B100139
(1)

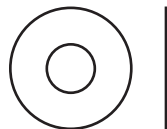

FLAT WASHER,
SS, 1/4 ID X 5/8
OD
B076332
(4)



HEX HEAD BOLT,
SS, 1/4-20 X 3/4
B063096
(4)

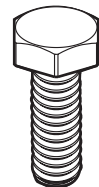

GRILL HEAD HARDWARE PACK - B102155

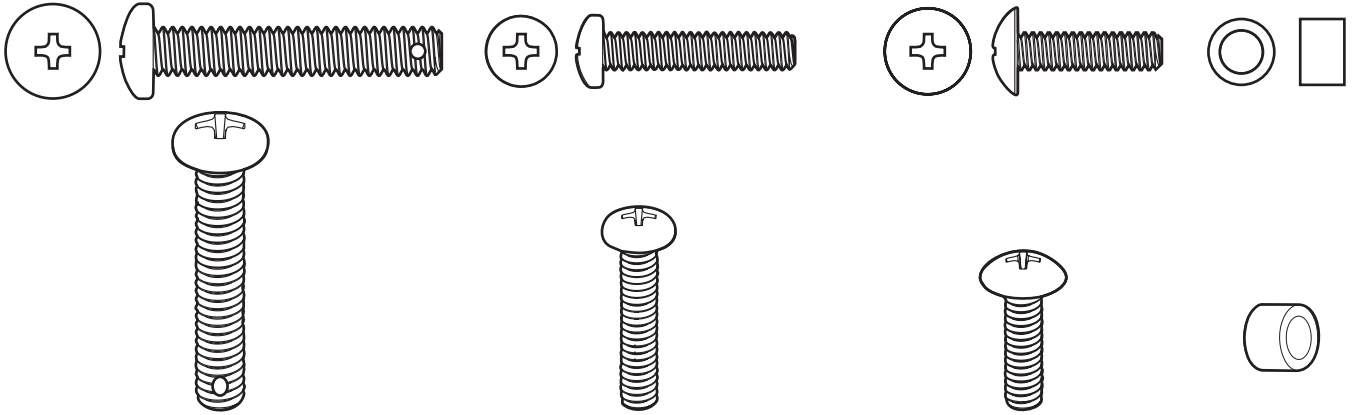

PHILLIPS PAN HEAD SCREW,
SS, 1/4-20 X 1-1/2
B101649
(1)

PHILLIPS PAN HEAD SCREW,
SS, 10-24 X 1
B073978
(2)

PHILLIPS TRUSS HEAD SCREW,
10-24 X 3/4
B100128
(1)

SPACER
B662325
(1)

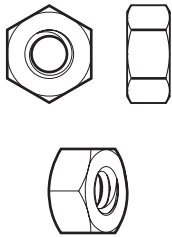

HEX NUT,
SS, 1/4-20
B076331
(1)

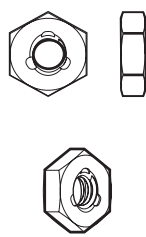

HEX LOCKNUT,
SS, 10-24
R4021
(1)

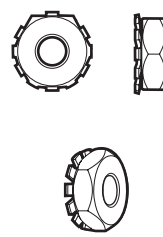

KEEPS NUT,
SS, 10-24
B073967
(2)

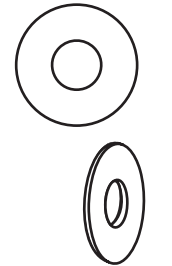

FLAT WASHER,
1/4 ID X 5/8 OD
B076332
(2)



COTTER PIN
B057805
(1)

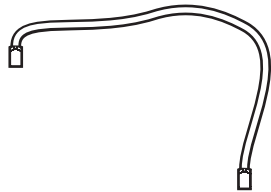

GROUND
WIRE
B072684
(1)

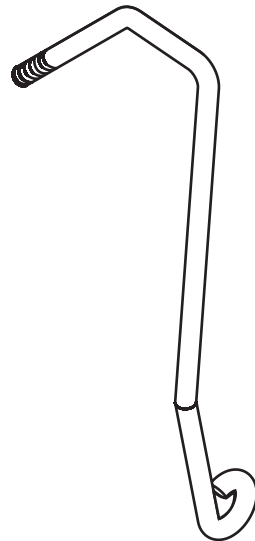

LID, STOP
B076521
(1)



KNOB, TAPERED
B100098
(1)

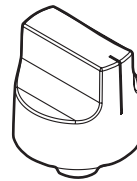

KNOB
B070084
(2)

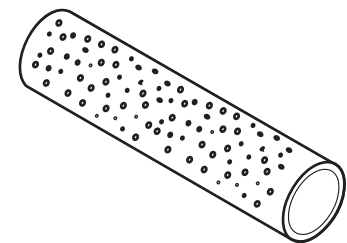

FOAM GRIP
B073097
(1)



BATTERY, AA
B076529
(1)

SHELF HARDWARE PACK - B101658

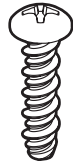

PHILLIPS PAN HEAD SCREW,
10-16 X 3/4
B100563
(4)

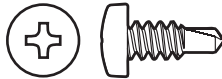

SELF-DRILLING PHILLIPS PAN HEAD SCREW,
SS, 10-16 X 1/2
R4059
(2)

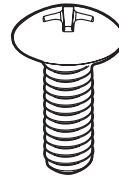
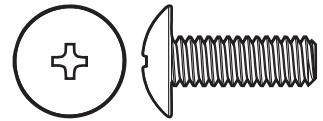

PHILLIPS TRUSS HEAD SCREW,
SS, 1/4-3/4
B072217
(2)

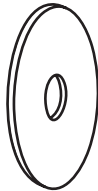
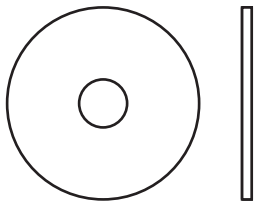

FLAT WASHER,
SS, 1/4 ID X 1
OD
B101640
(2)



LOCK WASHER,
1/4 ID X 1/2 OD
B076333
(2)

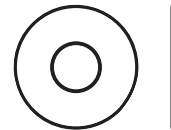

FLAT WASHER,
1/4 ID X 5/8 OD
B076332
(2)

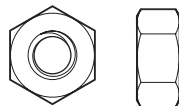

HEX NUT,
SS, 1/4-20
B076331
(2)

UNPACK AND REMOVE LID

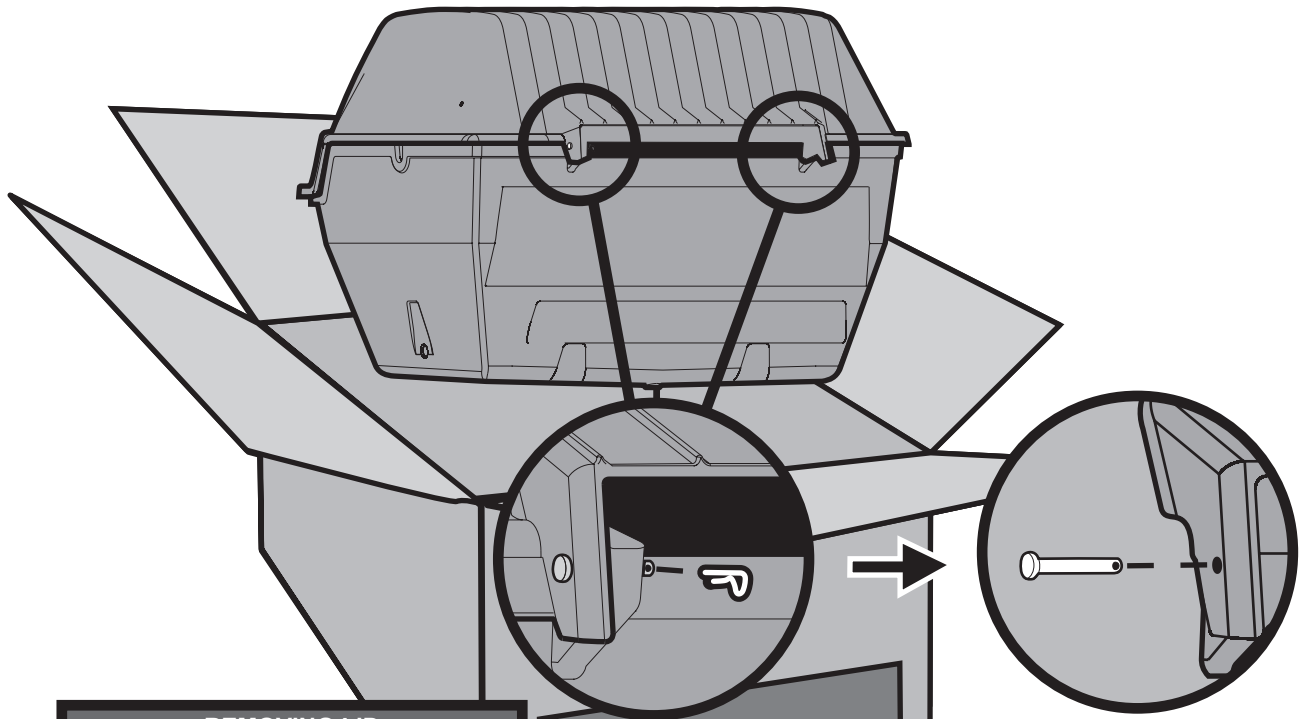

REMOVING LID

To ease assembly, remove Grill Lid and Warming Rack. Remove Warming Rack and set aside. Remove the two Pins and Clips at the rear of the Grill Lid and set aside. After Pins, Lid and Warming Rack have been removed, remove the contents from inside the Grill.

**BROILMASTER
PREMIUM GRILLS**

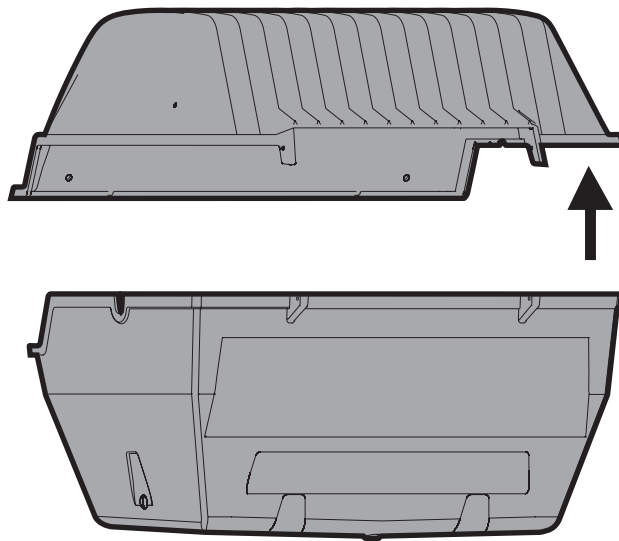

CART BASE ASSEMBLY

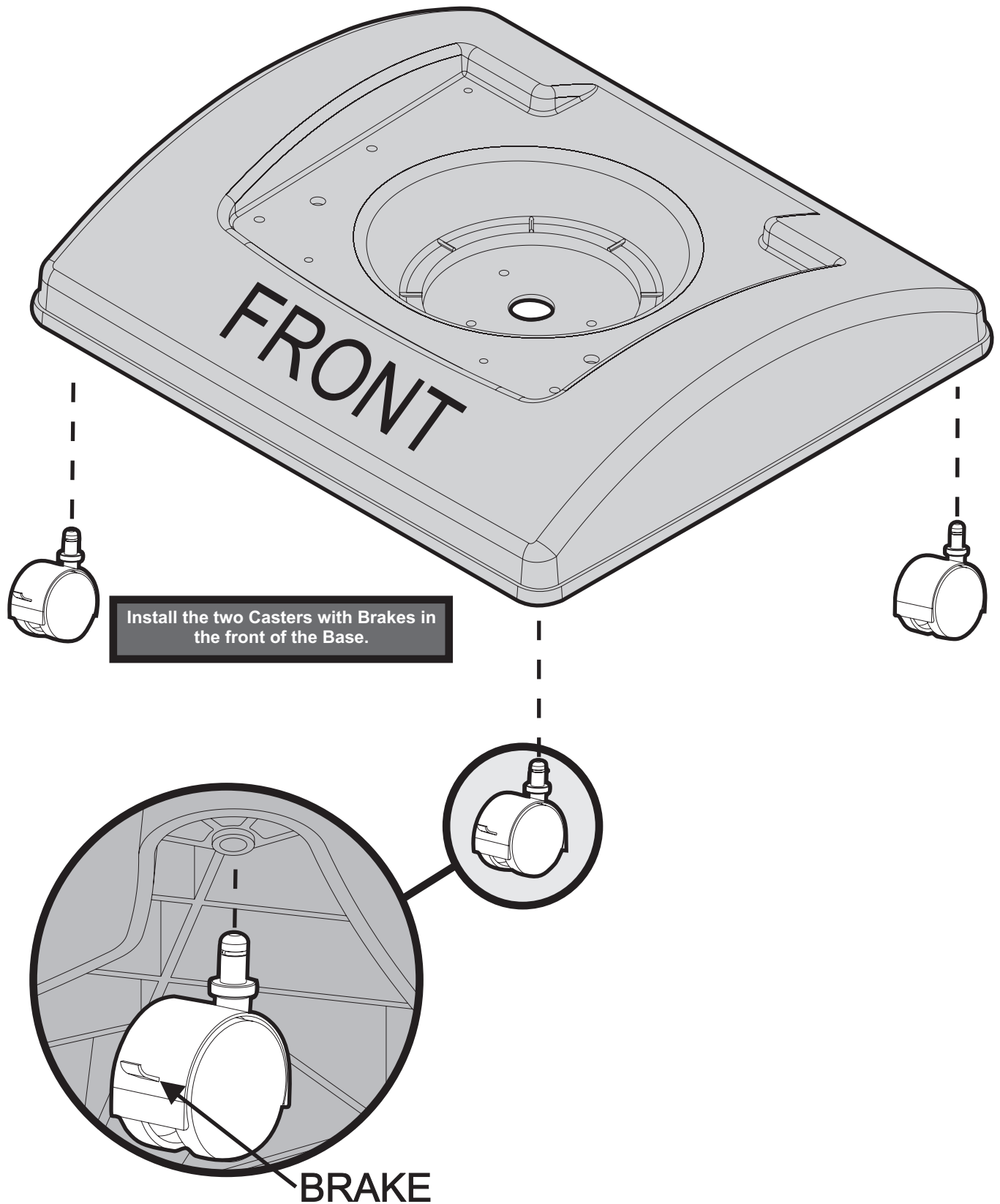

CART WALLS ASSEMBLY

PHILLIPS PAN HEAD SCREW,
SS, 10-24 X 1/2
R4056 (6)

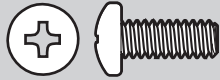

KEPS NUT,
SS, 10-24
B073967(6)

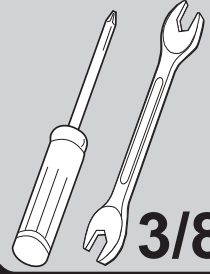
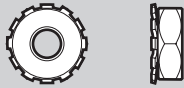

3/8"

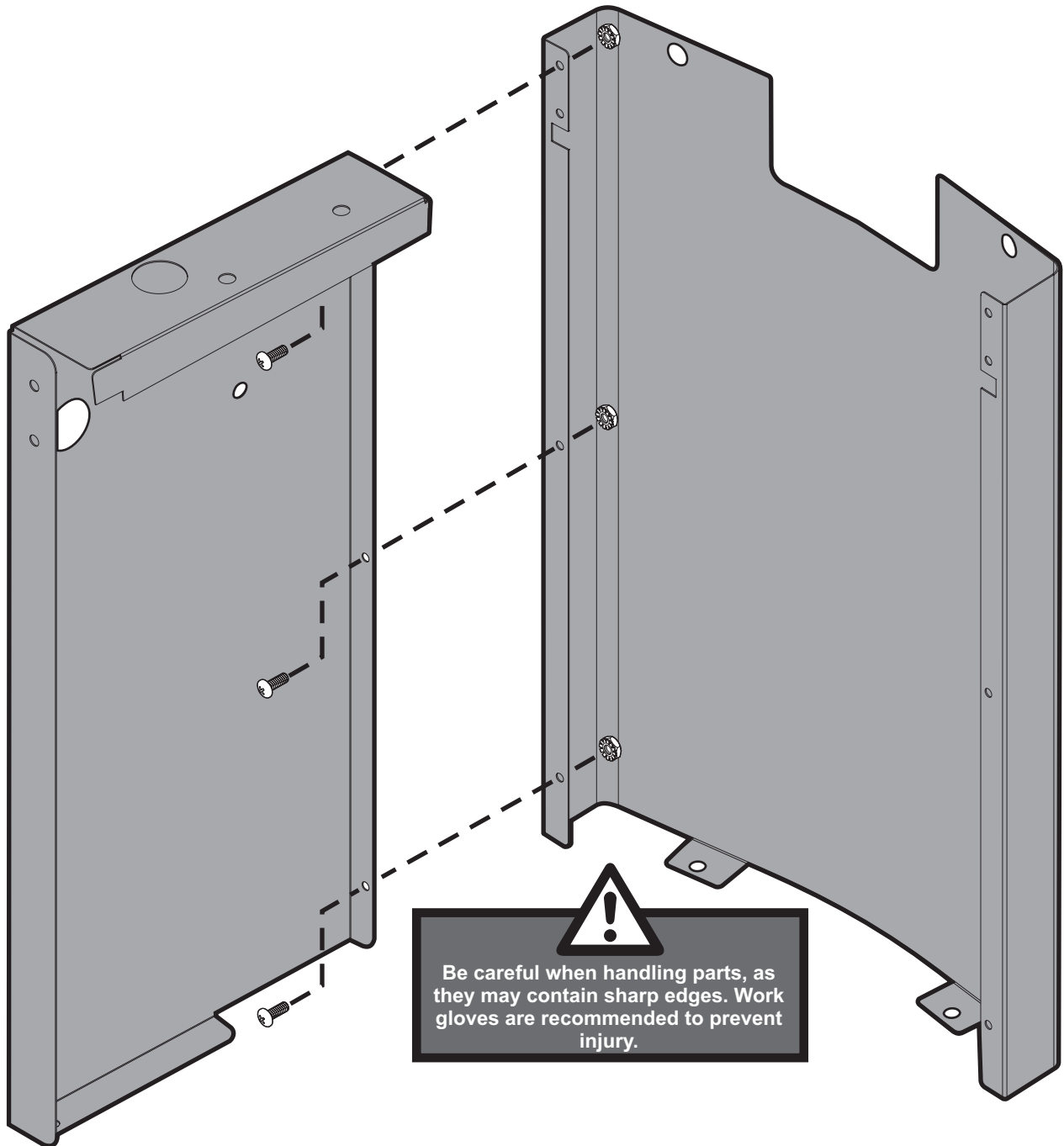

Be careful when handling parts, as they may contain sharp edges. Work gloves are recommended to prevent injury.

