

UBERHAUS

PORTABLE AIR CONDITIONER USER MANUAL

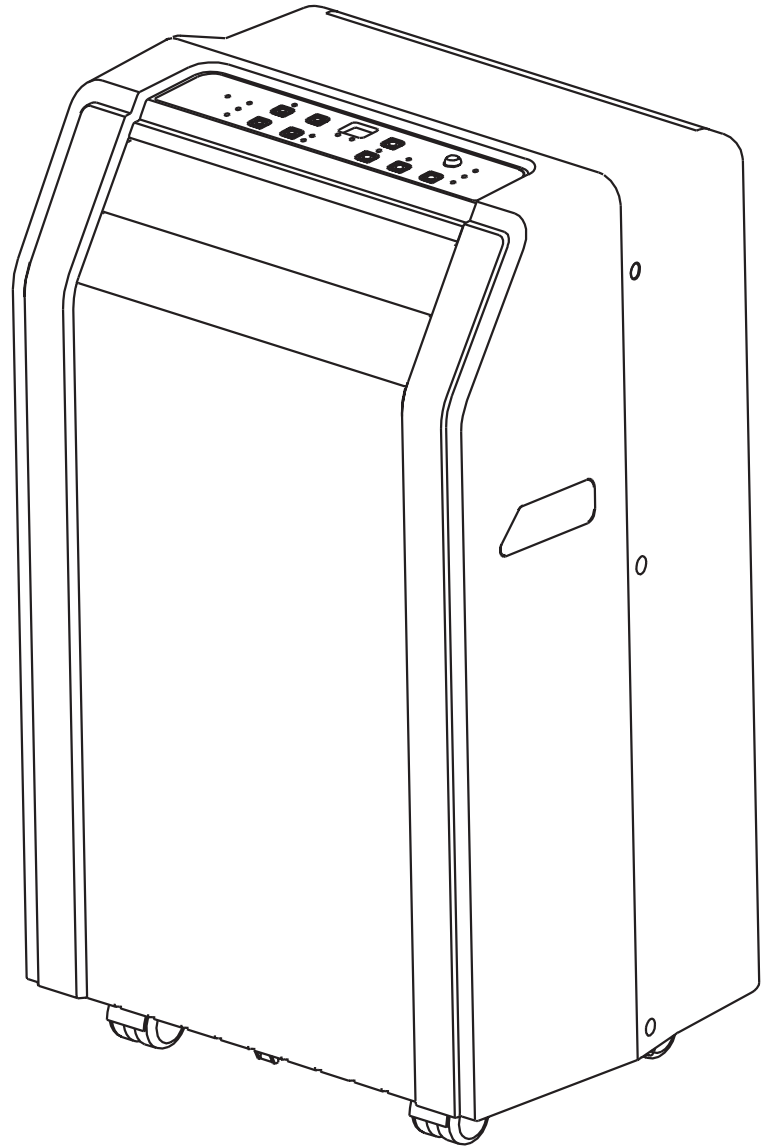

87795000
MPN1-08CRN1-BH9

87795002
MPN1-12CRN1-BH9

3
year/ans
warranty
garantie

Questions? 1-866-283-2239

SAVE THIS MANUAL

You will need this manual for safety instructions, operating procedures, and warranty. Put it and the original sales invoice in a safe, dry place for future reference.

CONSERVEZ CE GUIDE

Vous aurez besoin de ce guide pour les règles de sécurité, les procédures d'utilisation et la garantie. Conservez-le dans un endroit sûr et sec pour référence future.

CONTENTS

SAFETY PRECAUTIONS

Safety rules	2
Electrical information	2

IDENTIFICATION OF PARTS

Accessories	3
Names of parts.....	4

AIR CONDITIONER FEATURES

Electronic control operating instructions	5
---	---

OPERATING INSTRUCTIONS

Operating instructions	9
Operating condition	10

INSTALLATION INSTRUCTIONS

Location	11
Window kit installation	11
Exhaust hose installation	14

CARE AND MAINTENANCE

Care and maintenance	15
----------------------------	----

TROUBLESHOOTING TIPS

Troubleshooting	16
-----------------------	----

REMOTE CONTROLLER ILLUSTRATION

Remote controller illustration	17
--------------------------------------	----

WARANTY	24
----------------------	----

NOTE

The rating data indicated on the rating label is based on the testing condition of installing the un-extended air exhaust duct without adaptor (The duct and the adaptor are listed in the accessories chart of the Instruction Manual).

Safety rules

To prevent injury to the user or other people and property damage, the following instructions must be followed. Incorrect operation due to ignoring of instructions may cause harm or damage.

! Always do this

- Your air conditioner should be used in such a way that it is protected from moisture. e.g. condensation, splashed water, etc. Do not place or store your air conditioner where it can fall or be pulled into water or any other liquid. Unplug immediately should it become in contact with liquids.
- Always transport your air conditioner in a vertical position and stand on a stable, level surface during use.
- Turn off and unplug your air conditioner when not in use.
- Always contact a qualified person to carry out repairs. If the supply cord is damaged it must be repaired by a qualified repairer.
- Keep an air path of at least 1 ft (30cm) all around the unit from walls, furniture and curtains.
- If the air conditioner is knocked over during use, turn off the unit and unplug from the mains supply immediately.

⊘ Never do this

- Do not operate your air conditioner in a wet room such as a bathroom or laundry room.
- Do not touch the unit with wet or damp hands or when barefoot.
- Do not press the buttons on the control panel with anything other than your fingers.
- Do not remove any fixed covers. Never use this appliance if it is not working properly, or if it has been dropped or damaged.
- Never use the plug to start and stop the unit.
- Always use the switch on the control panel.
- Do not cover or obstruct the inlet or outlet grilles.
- Do not use hazardous chemicals to clean or come into contact with the unit. Do not use the unit in the presence of inflammable substances or vapour such as alcohol, insecticides, petrol, etc.
- Do not allow children to operate the unit unsupervised.
- Do not use this product for functions other than those described in this instruction manual.

Energy Saving Tips

- Use the unit in the recommended room size.
- Locate the unit where furniture cannot obstruct the air flow.
- Keep blinds/curtains closed during the sunniest part of the day.
- Keep the filters clean.
- Keep doors and windows closed to keep cool air in and warm air out.

▲ WARNING For your safety







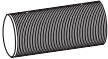

- Do not store or use gasoline or other flammable vapours and liquids in the vicinity of this or any other appliance.
- Avoid fire hazard or electric shock. **Do not use with an extension cord or an adaptor plug.** Do not remove any prong from the power cord.

▲ WARNING Electrical Information

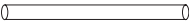
- Be sure the electrical service is adequate for the model you have chosen. This information can be found on the serial plate, which is located on the side of the cabinet and behind the grille.
- Be sure the air conditioner is properly grounded. To minimize shock and fire hazards, proper grounding is important. The power cord is equipped with a three-prong grounding plug for protection against shock hazards.
- Your air conditioner must be used in a properly grounded wall receptacle. If the wall receptacle you intend to use is not adequately grounded or protected by a time delay fuse or circuit breaker, have a qualified electrician install the proper receptacle.
- Ensure the receptacle is accessible after the unit has been installed.

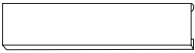
IDENTIFICATION OF PARTS

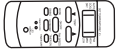
Accessories

PARTS :	PARTS NAME :	QUANTITY :
	Air Outlet Tie-in	1
	Air Outlet Pipe	1
	Adaptor	1
	Drain Hose(Continuous drainage)	1
	Window Slider Kit II	1
	Window Slider Kit I	1
	Foam	1
	Foam	2
	Remote Controller	1
	Battery	2

- Ensure that all accessories are included in the package and please refer to the installation instructions for their usage.

Suggested tools for window kit installation

1. Screwdriver (medium size Phillips)
2. Tape measure or ruler
3. Knife or scissors
4. Saw (In the event that the window kit needs to be cut down in size because the window is too narrow for direct installation)

NAMES OF PARTS



Before using this air conditioner, check the back of the unit to make sure that the lower drain plug is safely in place. See fig.2 12

FRONT VIEW

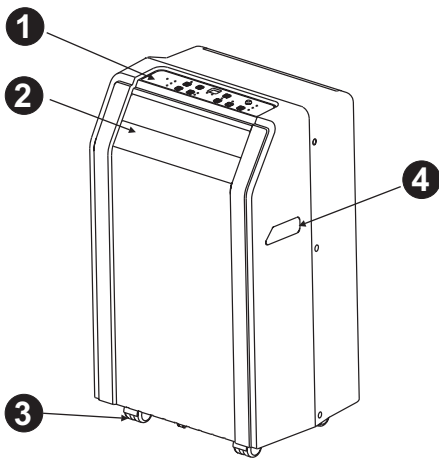

Fig.1

- 1 Operation Panel
- 2 Horizontal Louvers
- 3 Caster
- 4 Carrying Handle (both sides)

REAR VIEW

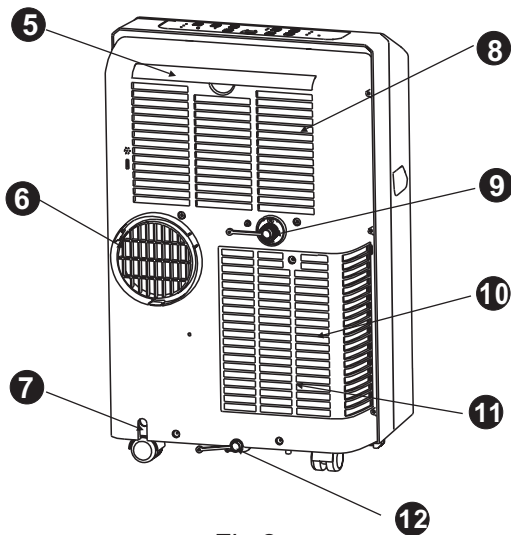

Fig.2

- 5 Upper Air Filter (Behind the grille)
- 6 Air Outlet
- 7 Power cord outlet
- 8 Air intake
- 9 Drain Outlet
- 10 Air intake
- 11 Lower Air Filter (Behind the grille)
- 12 Bottom Drain Plug

AIR CONDITIONER FEATURES

ELECTRONIC CONTROL OPERATING INSTRUCTIONS

Before you begin, thoroughly familiarize yourself with the control panel, remote controller and all functions, then follow the symbol for the functions you desire.
The unit can be controlled by the unit control panel alone or with the remote controller.

OPERATION PANEL OF THE AIR CONDITIONER

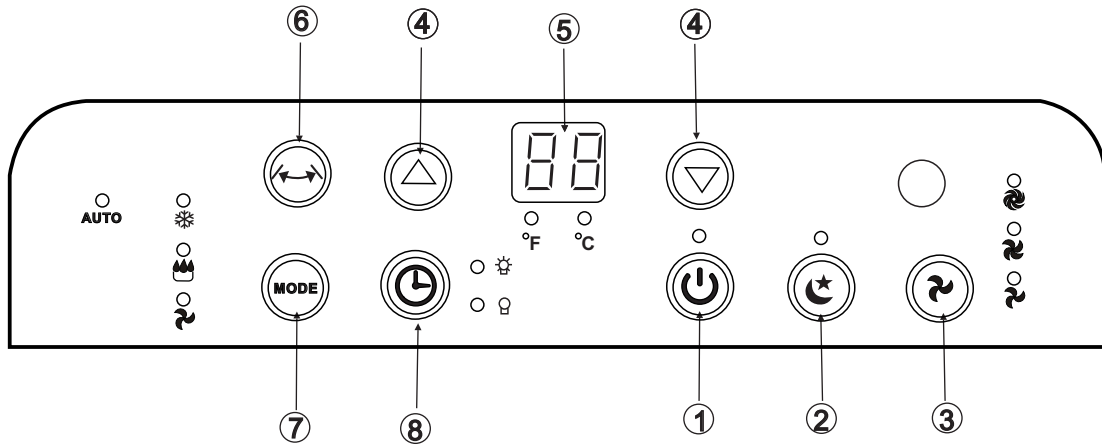
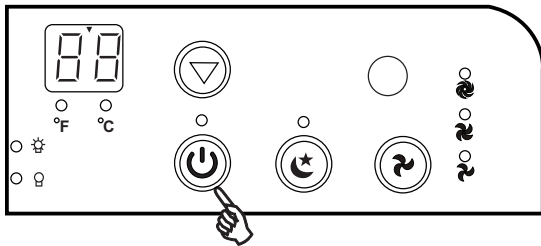



Fig.3

1 POWER button

NOTE:
 Power switch on/off.



2 SLEEP button

NOTE:
 Press this button, the selected temperature will increase (cooling) by 1°C/2°F in 30 minutes. The temperature will then increase (cooling) by another 1°C/2°F after an additional 30 minutes. This new temperature will be maintained for 7 hours before it returns to the originally selected temperature. Then the unit will continue to operate as originally programmed. The Sleep mode program can be cancelled at any time during operation by again pressing the  button, or turning off the unit, or pressing the MODE or  button. This feature is unavailable under FAN or DRY mode.

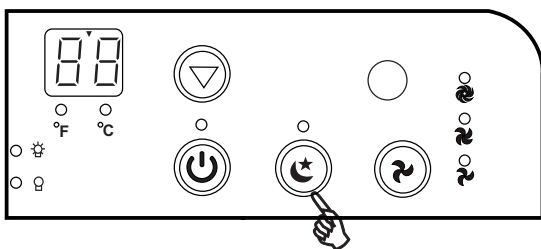

③ FAN button

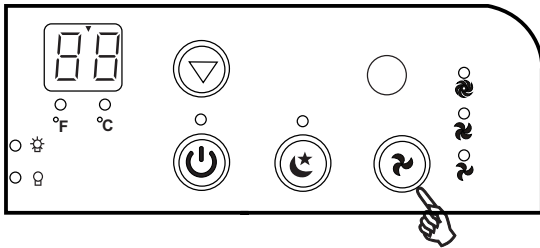

NOTE:

Used to select the Fan Speed in four steps- LOW, MED, HI and AUTO.

The fan speed indicator light illuminates under different fan settings except AUTO speed. Each time the button is pressed, the fan speed mode is shifted.

④ UP(Δ) and DOWN(▽) button

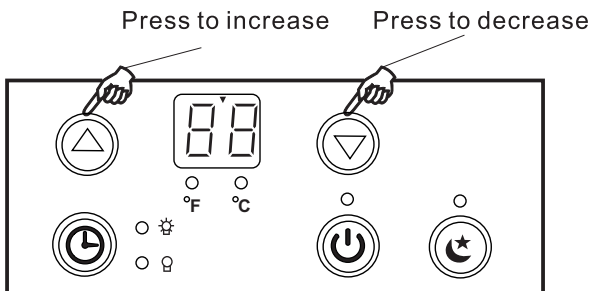

NOTE:

Used to adjust (increasing/decreasing) temperature settings (1°C/2°F increments) in a range of 17°C (62°F) to 30°C (88°F) or the TIMER setting in a range of 0~24hrs..

If you want the display to read the actual room temperature, see "To Operate on Dry Only" or "To Operate on Fan Only" section.

The control is capable of displaying temperature in Fahrenheit or Celsius degrees. To convert from one to the other, press and hold UP and DOWN buttons at the same time for 3 seconds.

⑤ LED Display

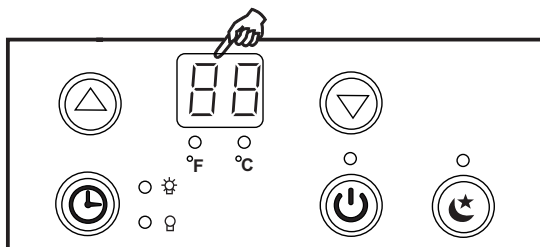

NOTE:

LED display shows the set temperature in "°C" or "°F" and the Auto-timer settings.

While on DRY and FAN modes, it shows the room temperature.

Error codes:



- E1-** Room temperature sensor error-
Unplug the unit and plug it back in.
If error repeats, call for service.
- E2-** Evaporator temperature sensor error-
Unplug the unit and plug it back in.
If error repeats, call for service.
- E4-** Display panel communication error-
Unplug the unit and plug it back in.
If error repeats, call for service.
- P1-** Bottom tray is full - Connect the drain hose and drain the collected water away. If error repeats, call for service.

AIR CONDITIONER FEATURES

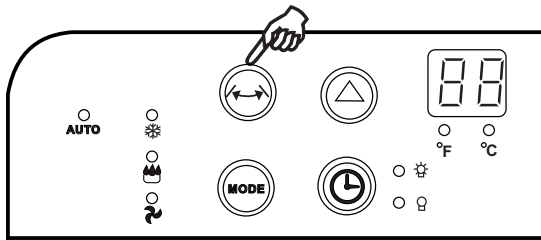
⑥ SWING button



Use the SWING button to adjust the UP/DOWN airflow direction (Perform this function while the unit is in operation).

1. Press the  button, the swing feature is activated.
2. Each press will change the swing angle by 6°. Keep pressing the button to move the horizontal louver to the desired position. If keep pressing the  button without releasing for 2 more seconds, the horizontal louver will swing up/down automatically.
3. Press the SWING button again to stop the movement.

⑦ MODE select button

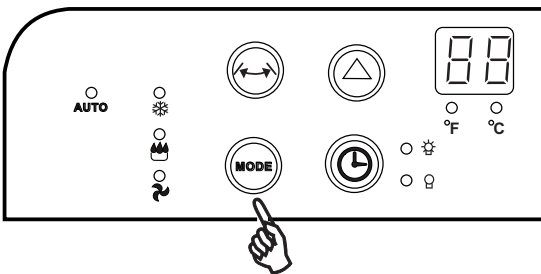

NOTE:

- To choose operating mode, press the MODE button. Each time you press the button, a mode is selected in a sequence that goes from AUTO, COOL, DRY, FAN. The indicator light beside will be illuminated and will remain on once the mode is selected.

To operate on Auto feature:

- In this mode, the fan speed can not be adjusted. When you set the air conditioner in AUTO mode, it will automatically select cooling or fan only operation to control room temperature set by you.

To operate on Cool feature:

- Press the ADJUST buttons "△" or "▽" to select your desired room temperature. The temperature can be set within a range of 17°C-30°C/62°F-88°F. Press the "FAN" button to choose the fan speed.

To operate on Fan Only:

- Use this function only when cooling is not desired, such as for room air circulation. You can choose any fan speed you prefer.
- During this function, the display will show the actual room temperature, not the set temperature as in the cooling mode.



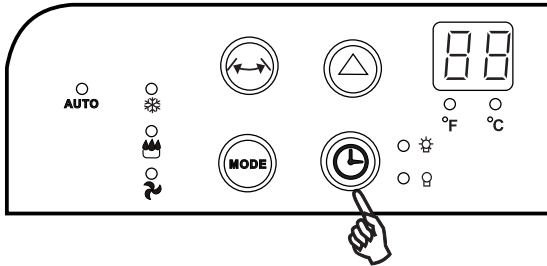

To operate on Dry Only:

- Under this mode, you cannot select a fan speed or adjust the temperature. The fan motor operates at LOW speed.
- Keep windows and doors closed for the best dehumidifying effect. Take off the exhaust hose and connect continuous drainage hose (locally purchased).
- During this function, the display will show the actual room temperature, not the set temperature as in the cooling mode.

⑧ TIMER button



NOTE:

- When the unit is on, first press the Timer button, the indicator light  illuminates. It indicates the Auto Stop program is initiated.
- When the unit is off, first press the Timer button, the indicator light  illuminates. It indicates the Auto Start program is initiated.
- Press or hold the UP  arrow or DOWN  arrow to change the Auto time by 0.5 hour increments, up to 10 hours, then at 1 hour increments up to 24 hours. The control will count down the time remaining until start.
- The selected time will register in 5 seconds and the system will automatically revert back to display the previous temperature setting.
- Turning the unit ON or OFF at any time or adjusting the timer setting to 0.0 will cancel the Auto Start/Stop function.
- When LED display window displays code of E1, E2 or E4, the Auto Start / Stop function will also be cancelled.

OPERATING INSTRUCTIONS

OPERATING INSTRUCTIONS

1 COOL OPERATION ❄️

- Press the "MODE" button several times until the " ❄️ " indicator light comes on.
- Press the UP and DOWN buttons "△" or "▽" to select your desired room temperature. The temperature can be set within a range of 17°C-30°C/62°F-88°F.
- Press the " 🌀 " button to choose the fan speed.

2 DRY OPERATION (DEHUMIDIFY) ☀️

- Press the "MODE" button until the " ☀️ " indicator light comes on.
- Under this mode, you cannot select a fan speed or adjust the temperature. The fan motor operates at LOW 🌀 speed.
- Keep windows and doors closed for the best dehumidifying effect.
- Do not put the duct to window.

3 FAN OPERATION 🌀

- Press the "MODE" button until the " 🌀 " indicator light comes on.
- Press the " 🌀 " button to choose the fan speed. The temperature can not be adjusted.
- Do not put the duct to window.

4 AUTO OPERATION

- Press the "MODE" button until the "AUTO " indicator light comes on.
- Under this mode, you can not select a fan speed. The fan motor operates at Auto fan speed. The temperature can be set within a range of 17°C-30°C/62°F-88°F.

5 TIMER OPERATION ⌚

Press the TIMER button ⌚ can set the auto-on/off time of the unit.

- When the unit is on, first press the Timer button ⌚ , the ⌚ indicator light illuminates. It indicates the Auto Stop program is initiated.
- When the unit is off, first press the Timer button ⌚ , the ☀️ indicator light illuminates. It indicates the Auto Start program is initiated.
- Press or hold the UP △ or DOWN ▽ button to change the Auto time by 0.5 hour increments, up to 10 hours, then at 1 hour increments up to 24 hours. The control will count down the time remaining until start.
- The selected time will register in 5 seconds and the system will automatically revert back to display the previous temperature setting.
- Turning the unit ON or OFF at any time or adjusting the timer setting to 0.0 will cancel the Auto Start/Stop timer program.
- When the malfunction (E1, E2 or E4) occurs, the Auto Start/Stop timer program will also be cancelled.

6 WATER DRAINAGE:

In dehumidifying mode:

- The drain hose installation should be done BEFORE turning on the unit
- Remove the drain plug from the back of the unit, attach a section of drain hose (included with this unit) to the hole. Place the open end of the hose directly over the drain area in your basement floor or in a water container (see Fig.4 & 5).
- You can also install the drain connector (5/8" (1.58cm) universal female mender) with 3/4" (1.9cm) hose (locally purchased by consumer) for garden hose use.

NOTE:

- When the water level of the bottom tray reaches a predetermined level, the unit beeps 8 times, the digital display area shows "P1" and the unit stops air conditioning/dehumidification process. However, the fan motor will continue to operate (this is normal). Carefully move the unit to a drain location, remove the bottom drain plug and let the water drain away (Fig.6). Restart the machine until the "P1" symbol disappears. If the error repeats, call for service.

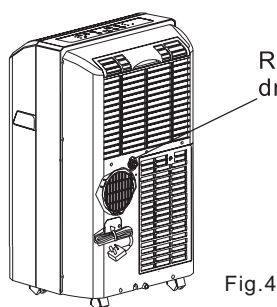

Fig.4

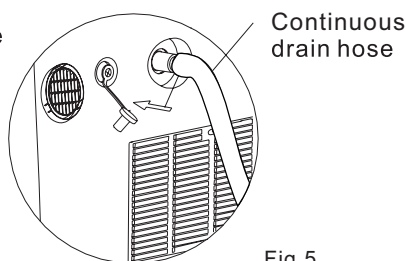

Fig.5

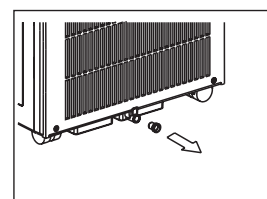

Fig.6

OPERATING CONDITION

- The air conditioner must be operated within the ambient temperature range indicated below:

MODE	ROOM TEMPERATURE
COOL	≥17°C/62°F
DRY	≥13°C/54°F

INSTALLATION INSTRUCTIONS

Location

- The air conditioner should be placed on a firm foundation to minimize noise and vibration. For safe and secure positioning, place the unit on a smooth, level floor strong enough to support the unit.
- The unit has casters for easier transport, but it should only be rolled on smooth, flat surfaces. Use caution when rolling on carpet surfaces. Do not attempt to roll the unit over objects.
- The unit must be placed within reach of a properly rated grounded socket.
- Never place any obstacles around the air inlet or outlet of the unit.
- Allow at least 1 ft (30 cm) of space from the wall for efficient air-conditioning.
- Do not use an extension cord or an adaptor plug.

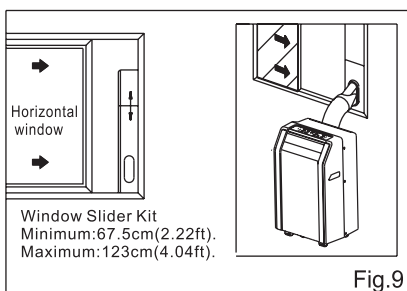
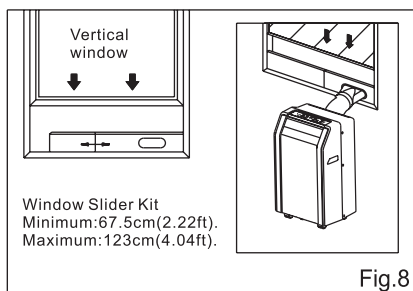
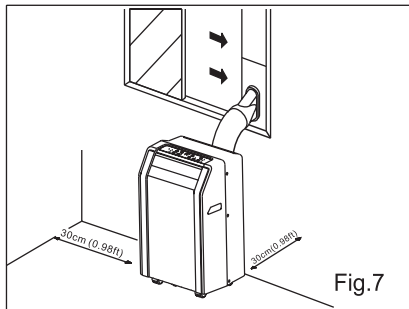

Window kit Installation

Your window kit has been designed to fit most standard "vertical" and "horizontal" window applications. However, it may be necessary for you to improvise/modify some aspects of the installation procedures for certain types of window. Please refer to Fig. 8 & Fig.9 for minimum and maximum window openings.

Note: If the window opening is less than the mentioned minimum length of the window slider kit, cut that one with holes in it short to fit for the window opening. Never cut out the hole in window slider kit.

Installation in double-hung sash windows

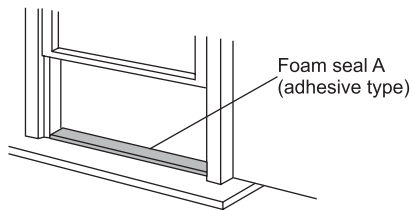

Fig.10

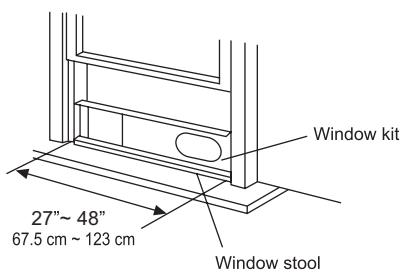

Fig.11

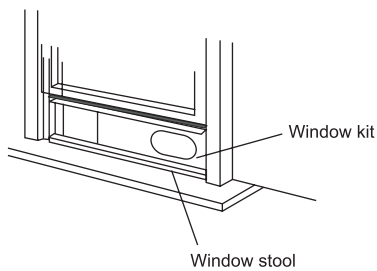

Fig.12

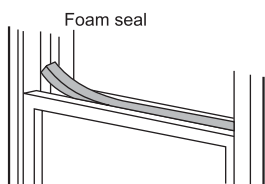

Fig.13

1. Cut the foam seal (adhesive type) to the proper length and attach it to the window stool. Fig.10

2. Attach the window slider kit to the window stool. Adjust the length of the window slider kit according to the width of window, shorten the adjustable window kit if the width of window is less than 27 inches (67.5 cm).
Open the window sash and place the window slider kit on the window stool. Fig.11

3. Cut the foam seal (adhesive type) to the proper length and attach it on the top of the window. See Fig.12

4. Close the window sash securely against the window.

5. Cut the foam seal to an appropriate length and seal the open gap between the top window sash and outer window sash. See Fig.13.

Installation in a sliding sash window

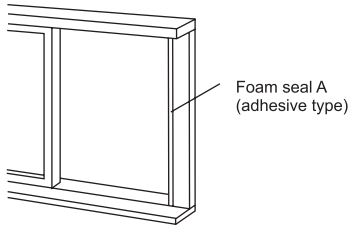

Fig.14

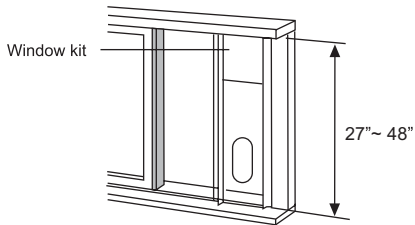

Fig.15

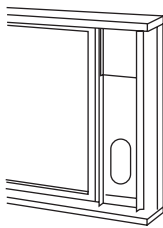

Fig.16

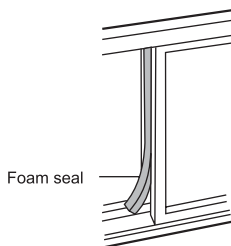

Fig.17

1. Cut the foam seal (adhesive type) to the proper length and attach it to the window frame. See Fig.14.

2. Attach the window slider kit to the window stool. Adjust the length of the window slider kit according to the width of window, shorten the adjustable window kit if the width of window is less than 27 inches (67.5 cm). Open the window sash and place the window slider kit on the window stool. See Fig.15.

3. Cut the foam seal (adhesive type) to the proper length and attach it on the top of the window. See Fig.16.

4. Close the sliding sash securely against the window.

5. Cut the foam seal to an appropriate length and seal the open gap between the top window sash and outer window sash. See Fig.17.

Exhaust hose installation:

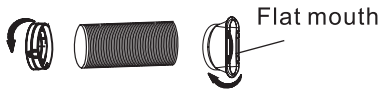

Fig.18

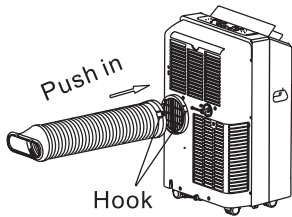

Fig.19

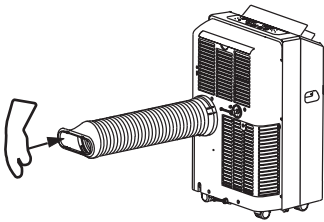

Fig.20

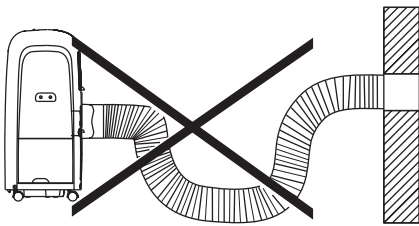

Fig.21

The exhaust hose and adaptor must be installed or removed in accordance with the usage mode.

COOL mode	Install
FAN or DEHUMIDIFY mode	Remove

1. Install the window Exhaust adaptor (flat mouth) onto the exhaust hose as shown in Fig.18. Refer to the previous pages for window kit installation.
2. Place the Exhaust hose over against the air outlet opening hook (See Fig.19) and flat the other end (See Fig.20) for quick installation.

NOTE:

- The duct can be compressed or extended moderately according to the installation requirement, but it is desirable to keep the duct length to a minimum.

IMPORTANT:

DO NOT OVER BEND THE DUCT (SEE Fig.21)

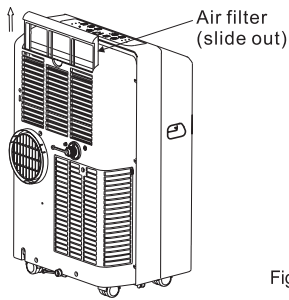

Fig.22

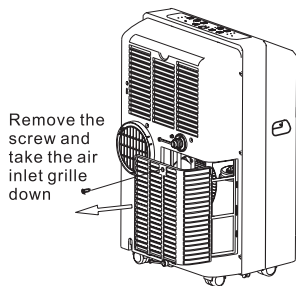

Fig.23

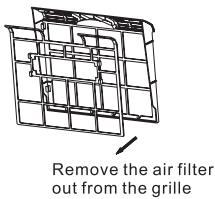

Fig.24

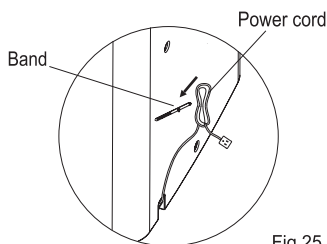

Fig.25

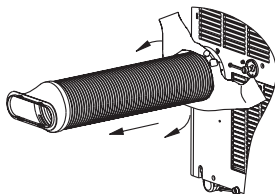

Fig.26

CARE AND MAINTENANCE

IMPORTANT:

- 1) Be sure to unplug the unit before cleaning or servicing.
- 2) Do not use gasoline, thinner or other chemicals to clean the unit.
- 3) Do not wash the unit directly under a tap or using a hose. It may cause electrical danger.
- 4) If the power cord is damaged, it should be repaired by the manufacturer or its agent.

1. Air filter

- Clean the air filter at least once two weeks to prevent dust from impacting fan operation.
- Removal
This unit has two filters. Grasp the upper filter tab(Fig.22), pull the filter out. Remove the lower filter by loosening the screws, take down the air inlet grille, then remove the air filter as shown in Fig.23 & 24.
- Cleaning
Wash the air filter by immersing it gently in warm water (about 40°C/104°F) with a neutral detergent. Rinse the filter and dry it in a cool, dry place.
- Mounting
Insert the upper air filter from upward after cleaning, attach the lower air filter on the air inlet grille, then install the grille by using the screw.

2. Unit enclosure

- Use a lint-free cloth soaked with neutral detergent to clean the unit enclosure. Finish with a dry clean cloth.

3. If unit has been idle for a long time

- Remove the rubber plug at the back of the unit and attach a hose to drain outlet. Place the open end of the hose directly over the drain area in your basement floor (See Fig.4 & 5).
- Remove the plug from the bottom drain outlet, all the water in the bottom tray would drain out (See Fig.6).
- Keep the appliance running on FAN mode for half a day in a warm room to dry the appliance inside and prevent mold.
- Stop the appliance and unplug it, wrap the cord and bundle it with the tape (Fig.25). Remove the batteries from the remote controller.
- Clean the air filter and reinstall it.
- Unscrew the exhaust hose to the right or left and pull out for uninstillation (Fig.26), keep it safety.

TROUBLESHOOTING

TROUBLES	POSSIBLE CAUSES	SUGGEST REMEDIES
1. Unit does not start when pressing on/off button	- P1 appears in the display window	Drain the water in the bottom tray.
	- Room temperature is lower than the set temperature.(Cooling mode)	Reset the temperature.
2. Not cool enough	- The windows or doors in the room are not closed.	Make sure all the windows and doors are closed.
	- There are heat sources inside the room.	Remove the heat sources if possible.
	- Exhaust air duct is not connected or blocked.	Connect the duct and make sure it can function properly.
	- Temperature setting is too high.	Decrease the set temperature.
	- Air filter is blocked by dust.	Clean the air filter.
3. Noise or vibration	- The ground is not level or not flat enough.	Place the unit on a flat, level ground if possible.
4. Gurgling sound	- The sound comes from the flowing of the refrigerant inside the air-conditioner.	It is normal.

REMOTE CONTROLLER ILLUSTRATION

Handling the remote controller

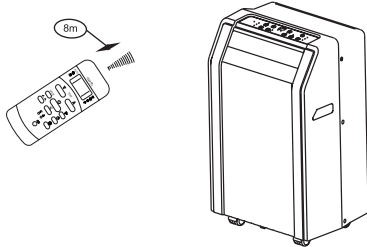

Location of the remote controller.

- Use the remote controller within a distance of 26 ft (8 m) from the appliance, pointing it towards the receiver. Reception is confirmed by a beep.

▲ CAUTIONS

- The air conditioner will not operate if curtains, doors or other materials block the signals from the remote controller to the unit.
- Prevent any liquid from falling into the remote controller. Do not expose the remote controller to direct sunlight or heat.
- If the infrared signal receiver on the unit is exposed to direct sunlight, the air conditioner may not function properly. Use curtains to prevent the sunlight from falling on the receiver.
- If other electrical appliances react to the remote controller, either move these appliances or consult your local dealer.

Replacing batteries

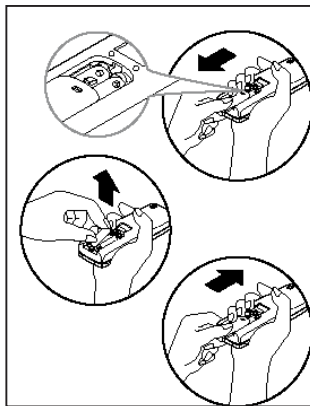

The remote controller is powered by two dry batteries (R03/LR03X2) housed in the rear part and protected by a cover.

- (1) Remove the cover by pressing and sliding off.
- (2) Remove the old batteries and insert the new batteries, placing the (+) and (-) ends correctly.
- (3) Reattach the cover by sliding it back into position.

NOTE: When the batteries are removed, the remote controller erases all programming. After inserting new batteries, the remote controller must be reprogrammed.

▲ CAUTIONS

- Do not mix old and new batteries or batteries of a different type.
- Do not leave the batteries in the remote controller if it is not going to be used for 2 or 3 months.
- Dispose of used batteries in the special containers to that effect, available in your local hardware store.

Remote Controller Specifications

Model	R51113/BG(C)E
Rated Voltage	3.0V (Dry batteries R03/LR03×2)
Lowest Voltage of CPU Emitting Signal	2.0V
Signal Receiving Range	36 ft / 8m (36 ft / 11m range with 3.0V)
Environment	-5°C~60°C (23°F ~140°F)

NOTE:

Temperature setting display: Fahrenheit scale(°F), R51113/BG(C)E

Performance Features

1. Operating mode: AUTO, COOL, DRY, and FAN.
2. Timer setting function in 24 hours.
3. Indoor setting temperature range : 17°C~30°C(62°F~88°F).
- 4 Full LCD (liquid cristal display) screen.
5. Back light.

Function buttons

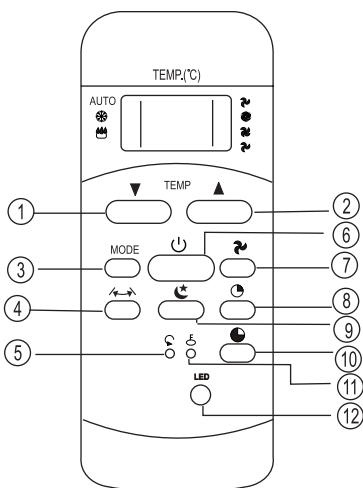

Model: R51113/BG(C)E

- 1 TEMP DOWN Button ▼**
Push this button to decrease the indoor temperature setting in 1°C(2°F) increments to 17°C(62°F).
- 2 TEMP UP Button ▲**
Push this button to increase the indoor temperature setting in 1°C(2°F) increments to 30°C(88°F).
- 3 MODE Button**
Each time the button is pressed, the operation mode is selected in the sequence of the following:
- 4 SWING Button ↔**
Used to stop or start louver movement and set the desired up/down airflow direction.
- 5 RESET Button ↻**
Once the recessed RESET button is pressed, all of the current settings will be cancelled and the controller will return to the initial settings.
- 6 ON/OFF Button ⏻**
Operation starts when this button is pressed and stops when the button is pressed again.
- 7 FAN SPEED Button 🌀**
Used to select the fan speed in four steps:

REMOTE CONTROLLER ILLUSTRATION

Function buttons continued

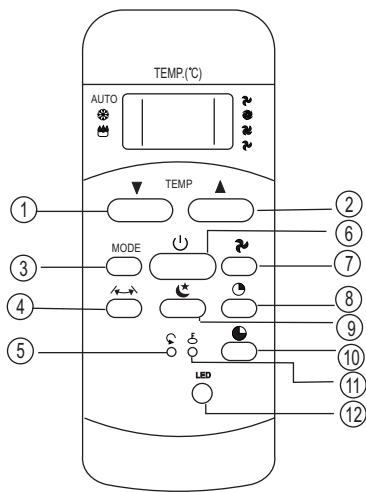

Model: R51113/BG(C)E

8 TIMER ON Button

Press this button to activate the Auto-on time setting. Each press will increase the time setting in 30 minutes increments, up to 10 hours, then at 1 hour increments up to 24 hours. To cancel the Auto-on time setting, just press the button until the time setting is 0.0.

9 ECONOMY(SLEEP) Button

Select this function during the sleeping time. It can maintain the most comfortable temperature and save energy. This function is available on COOL or AUTO mode only .

NOTE: The ECONOMY mode program can be cancelled at any time by pressing ECONOMY button, MODE button or FAN SPEED button .

10 TIMRT OFF Button

Press this button to activate the Auto-off time setting. Each press will increase the time setting in 30 minute increments, up to 10 hours, then at 1 hour increments up to 24 hours. To cancel the Auto-off time setting, just press the button until the time setting is 0.0.

11 LOCK Button

Press this recessed button to lock all current settings, and the remote controller will not accept any operation except that of the LOCK. Use the LOCK mode when you want to prevent settings from being changed accidentally. Press the LOCK button again to cancel the LOCK function. A lock symbol will appear on the remote controller display when the lock function is activated.

12 LED Display Button

Press this button to clear the display on the unit, press it again to light the display .

Indicators on LCD screen

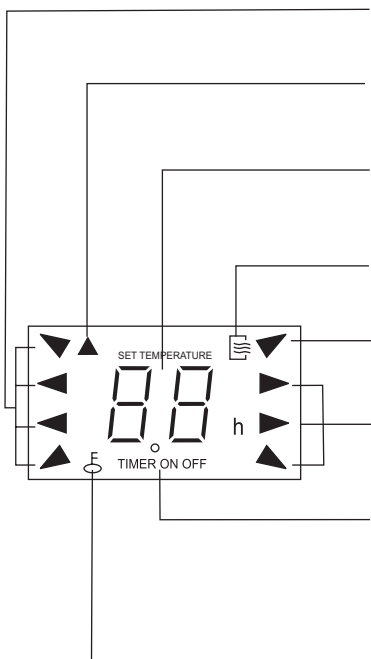

MODE display

Displays the current selected mode. Including AUTO, COOL, DRY, and FAN.

Transmission Indicator

This transmission indicator will light when remote controller transmits signals to the unit.

Temp./Timer display

The temperature setting (from 17°C(62° F) to 30°C(88°F)) or timer setting (0~24h) will be displayed. If FAN mode is selected, there will be no display.

ON/OFF display

This indicator will be displayed when the unit is operating.

MODE display(FAN mode)

FAN SPEED display

Displays the selected fan speed: AUTO, HIGH, MED and LOW. Nothing displays when the fan speed is selected in AUTO speed. When AUTO or DRY Mode is selected, there will be no signals displayed.

TIMER display

This display area shows the settings of the TIMER. That is, if only the Auto-on time function is set, it will display TIMER ON. If only the Auto-off time function is set, it will display TIMER OFF. If both functions are set, it will display TIMER ON OFF which indicates you have chosen both the Auto-on time and Auto-off time.

LOCK Indicator

LOCK display is displayed when pushing the LOCK button. Push the LOCK button to clear display.

REMOTE CONTROLLER ILLUSTRATION

How to use the buttons

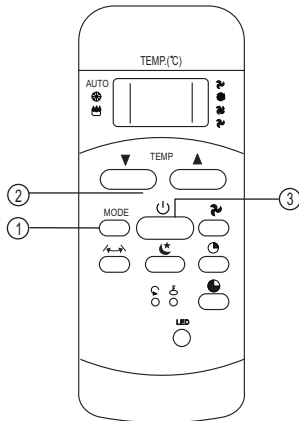

Auto operation

Ensure the unit is plugged in and power is available. The OPERATION indicator on the display panel of the unit illuminates.

1. Press the MODE button to select AUTO.
2. Press the TEMP button to set the desired temperature. The temperature can be set within a range of 17°C(62°F)~ 30°C in 1°C(2°F) increments.
3. Press the  button to start the air conditioner.



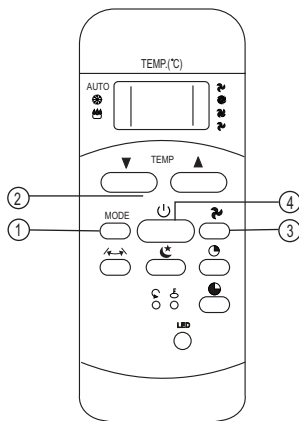

NOTE

1. In the AUTO mode, the air conditioner can logically choose the mode of Cooling, Fan, and Dehumidifying by sensing the difference between the actual ambient room temperature and the set temperature on the remote controller.
2. In the AUTO mode, you can not switch the fan speed. It has already been automatically controlled.
3. If the AUTO mode is not comfortable for you, the desired mode can be selected manually.



Cooling /Fan operation

Ensure the unit is plugged in and power is available.

1. Press the MODE button to select COOL, or FAN mode.
2. Press the TEMP button to set the desired temperature. The temperature can be set within a range of 17°C(62°F)~ 30°C in 1°C(2°F) increments.
3. Press the  button to select the fan speed in four steps- AUTO, LOW , MED , or HIGH .
4. Press the  button to start the air conditioner.

NOTE

In the FAN mode, the setting temperature is not displayed in the remote controller and you are not able to control the room temperature either. In this case, only step 1, 3 and 4 may be performed.

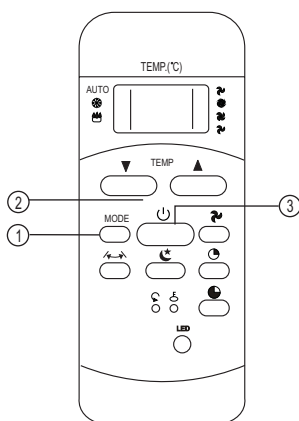

Dehumidifying operation

Ensure the unit is plugged in and power is available. The OPERATION indicator on the display panel of the unit illuminates.

1. Press the MODE button to select DRY mode.
2. Press the TEMP button to set the desired temperature. The temperature can be set within a range of 17°C(62°F)~ 30°C in 1°C(2°F) increments.
3. Press the ON/OFF button to start the air conditioner.

NOTE

In the Dehumidifying mode, you can not switch the fan speed. It has already been automatically controlled.

REMOTE CONTROLLER ILLUSTRATION

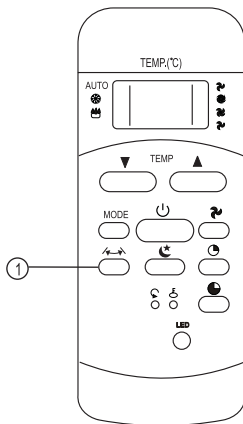

Swing operation ↔

Use the ↔ button to adjust the Up/Down airflow direction.

1. When press the button once and quickly, the air flow direction setting feature of the louver is activated. The moving angle of the louver is 6° for each press. Keep pressing the button to move the louver to the desired position.
2. If keep pressing the ↔ button without releasing for 2 more seconds, the auto swing feature of the louver is activated. The horizontal louver will swing up/down automatically. Press it again to stop.

NOTE: When the louver swing or move to a position which would affect the cooling effect of the air conditioner, it would automatically change the swing/moving direction.

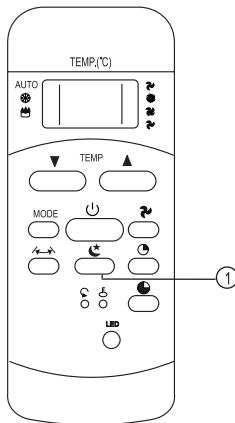

ECONOMY(SLEEP) operation ☆

Press this button, the selected temperature will increase (cooling) by 1°C/2°F 30 minutes. The temperature will then increase (cooling) by another 1°C/2°F after an additional 30 minutes. This new temperature will be maintained for 7 hours before it returns to the originally selected temperature. Then the unit will continue to operate as originally programmed. It can maintain the most comfortable temperature and save energy.

NOTE: The ECONOMY/SLEEP function is only available under Cooling, and AUTO operation.

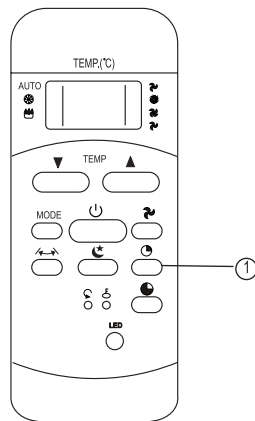

Timer operation

Press the ⌚ button to set the auto-on time of the unit. Press the ⌚ button to set the auto-off time of the unit.

To set the Auto-on time.

1. Press the ⌚ button. The remote controller shows TIMER ON, the last Auto-on setting time and the signal "h" will be shown on the LCD display area. Now it is ready to reset the Auto-on time to START the operation.
2. Push the ⌚ button again to set desired Auto-on time. Each time you press the button, the time increases in 30 minutes increments, up to 10 hours, then at 1 hour increments up to 24 hours.
3. After setting the ⌚, there will be a one-half second delay before the remote controller transmits the signal to the air conditioner. Then, after approximately another 2 seconds, the signal "h" will disappear and the set temperature will re-appear on the LCD display window.

REMOTE CONTROLLER ILLUSTRATION

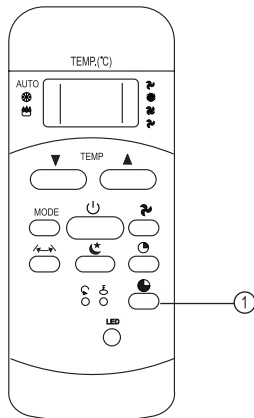

To set the Auto-off time.

1. Press the TIMER OFF button. The remote controller shows TIMER OFF, the last Auto-off setting time and the signal "h" will be shown on the LCD display area. Now it is ready to reset the Auto-off time to START the operation.
2. Push the TIMER OFF button again to set desired Auto-off time. Each time you press the button, the time increases in 30 minutes increments, up to 10 hours, then at 1 hour increments up to 24 hours.
3. After setting the TIMER OFF, there will be a one-half second delay before the remote controller transmits the signal to the air conditioner. Then, after approximately another 2 seconds, the signal "h" will disappear and the set temperature will re-appear on the LCD display window.

IMPORTANT

- The effective operation time set by the remote controller for the timer function is limited to the following settings: 0.5, 1.0, 1.5, 2.0, 2.5, 3.0, 3.5, 4.0, 4.5, 5.0, 5.5, 6.0, 6.5, 7.0, 7.5, 8.0, 8.5, 9.0, 9.5, 10, 11, 12, 13, 14, 15, 16, 17, 18, 19, 20, 21, 22, 23 and 24.

Example of Timer setting

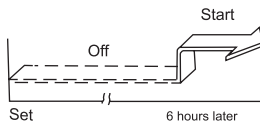

TIMER ON (Auto-on Operation)

The TIMER ON feature is useful when you want the unit to turn on automatically before you return home, for example. The air conditioner will automatically start operating at the set time.

Example:

To start the air conditioner in 6 hours.

1. Press the TIMER ON button, the last setting of starting operation time and the signal "h" will show on the display area.
2. Press the TIMER ON button to display "6:0 h" on the TIMER ON display of the remote controller.
3. Wait for 0.5 second and the TIMER ON indicator stops flashing and this function is activated. The digital display area will show the temperature again.

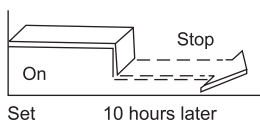
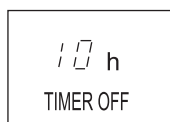

TIMER OFF (Auto-off Operation)

The TIMER OFF feature is useful when you want the unit to turn off automatically after you go to bed. The air conditioner will stop automatically at the set time.

Example:

To stop the air conditioner in 10 hours.

1. Press the TIMER OFF button, the last setting of stopping operation time and the signal "h" will show on the display area.
2. Press the TIMER OFF button to display "10h" on the TIMER OFF display of the remote controller.
3. Wait for 0.5 second and the TIMER OFF indicator stops flashing and this function is activated. The digital display area will show the temperature again.

REMOTE CONTROLLER ILLUSTRATION

COMBINED TIMER

(Setting both ON and OFF timers simultaneously)

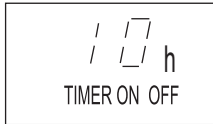

TIMER OFF → TIMER ON

(On → Stop → Start operation)

This feature is useful when you want to stop the air conditioner after you go to bed, and start it again in the morning when you wake up or when you return home.

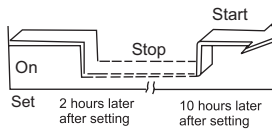

Example:

To stop the air conditioner 2 hours after setting and start it again 10 hours after setting.

1. Press the TIMER OFF button.
2. Press the TIMER OFF button again to display 2.0h on the TIMER OFF display.
3. Press the TIMER ON button.
4. Press the TIMER ON button again to display 10h on the TIMER ON display.
5. Wait for the remote control to display the setting temperature.



TIMER ON → TIMER OFF

(Off → Start → Stop operation)

This feature is useful when you want to start the air conditioner before you wake up and stop it after you leave the house.

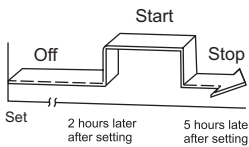

Example:

To start the air conditioner 2 hours after setting, and stop it 5 hours after setting.

1. Press the TIMER ON button.
2. Press the TIMER ON button again to display 2.0h on the TIMER ON display.
3. Press the TIMER OFF button.
4. Press the TIMER OFF button again to display 5.0h on the TIMER OFF display.
5. Wait for the remote control to display the setting temperature.

▲ CAUTION

- The timer setting (TIMER ON or TIMER OFF) that in sequence occurs directly after the set time will be activated first.

WARRANTY

Thank you for purchasing this UBERHAUS product. These products have been made to demanding high-quality standards and are guaranteed for domestic use against manufacturing faults for a period of 36 months from the date of purchase. This warranty does not affect your statutory rights.

For service within the warranty period, please contact the store where the product was purchased. Product model number and proof of purchase are required for any service request. RONA reserves the right to repair or replace the defective product, at its discretion.

For any questions, please contact our toll-free service line at 1-866-206-0888 from 8 AM to 6 PM, Monday to Friday, Eastern time.

The product is guaranteed for 36 months if used for normal trade purposes and is valid for the original buyer only. Any warranty is deemed invalid if the product has been overloaded or used improperly, or subject to neglect, attempted repair other than by an authorized agent. Heavy-duty, daily professional or hire usage are not guaranteed. RONA is not responsible for any costs related to labour, injuries or any other loss incurred during the product installation, repair or replacement, including any indirect or consequential damages.

Due to continuous product improvement, we reserve the right to change the product specification without prior notice.